

Evaluation Report

696



Case IH 8500 Air Hoe Drill

A Co-operative Program Between



CASE IH 8500 AIR HOE DRILL

MANUFACTURER:

JI Case Canada
A Division of Tenneco Canada Inc.
3350 S. Service Road
Burlington, Ontario
L7N 3M5

DISTRIBUTOR:

JI Case Canada
A Division of Tenneco Canada Inc.
240 Henderson Drive
P.O. Box 5051
Regina, Saskatchewan
S4P 3M3
Phone: (306) 924-1637

RETAIL PRICE

\$77,862.00 Standard Equipment: Case IH 8500 Air Hoe Drill,
45 ft (13.7 m), with 7 in (178 mm) spring hoe spacing
3,825.00 Optional Equipment: Blockage monitor
2,349.00 Optional Equipment: 3 x 20 in (76 x 508 mm)
convex steel press wheels
\$84,036.00 Retail Price: June, 1993 f.o.b. Hamilton, Ontario

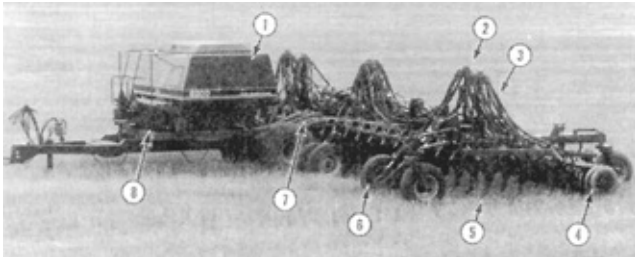

FIGURE 1. Case IH 8500 Air Hoe Drill: (1) Tank, (2) Manifold, (3) Secondary Hose, (4) Steel Press Wheels, (5) Openers, (6) Gauge Wheels, (7) Primary Hose and (8) Hydraulic Fan.

SUMMARY

QUALITY OF WORK

Penetration of the Case IH 8500 with the spring trip hoe openers was very good. The six section frame allowed the drill to follow the contour of the land very well except in sharp gullies or hills.

The seed and fertilizer placement was very good. Variation in seed and fertilizer depth was uniform when seeding in either tilled or untilled soil.

Soil finishing was very good. The majority of the stubble was left standing after seeding into untilled stubble field conditions. The packing force was adequate for the soils and conditions encountered during the test.

Residue clearance was good. Plugging occurred in fields with high amounts of straw, high standing stubble or weed infestations.

Operation in stony conditions was very good. Maximum trip height for the shank assembly ranged from 7 to 9 in (178 to 229 mm).

Metering accuracy was good. Fertilizer flowed by the meters on a 15 degree downhill slope. Travelling on a 15 degree uphill slope caused a 23 percent decrease in the metering rate of 11-51-0 fertilizer. Uniformity of distribution of the application rates was good. The CV's ranged from 6.5 to 10.5 percent depending on the rate and material.

EASE OF OPERATION AND ADJUSTMENT

Ease of performing routine maintenance was fair. One hour was required to lubricate the 129 grease fittings on the unit.

Ease of filling and cleaning was fair. A drill fill or grain auger was needed to fill the tanks. The tank openings were

not covered by a screen to prevent blockages in the distribution system. The centre of the seed tank emptied faster than the sides due to the position of the tank supports.

Cleaning large amounts of seed or fertilizer out of the tanks was difficult. Moisture leaked in and around the fertilizer meters causing fertilizer to cake after a rain.

Ease of transporting was very good. Five minutes were required to place the unit into transport position. Caution was required when transporting the unit on public roads. The unit required the use of a tractor with two sets of remote hydraulics, a 1000 rpm power take-off and a seven pin electrical connection.

Monitoring was very good. The electronic monitoring system monitored fan speed, front and rear tank levels, shaft rotation, seed and fertilizer blockage.

Ease of setting the application rate for seed and fertilizer was very good. The unit was calibrated by removing the primary hoses behind the tank and attaching sacks to collect the material.

Ease of setting the seeding depth was good. The seeding depth was set at the left master cylinder by adjusting the hydraulic depth stop. The unit was then levelled front to back by adjusting the height of the packer wheel assemblies.

POWER REQUIREMENTS

Average power take-off horsepower requirements to run the hydraulic system ranged from 16 to 30 hp (12 to 23 kW). The overall tractor size needed to operate the test unit varied from 188 to 226 PTO hp (141 to 170 PTO kW).

OPERATOR SAFETY

The unit was safe to operate if normal safety precautions were observed. A wide platform with railing provided easy access to the tank opening.

OPERATOR'S MANUAL

The operator's manual was very good. The manual was clearly written with photographs and illustrations for explanations.

MECHANICAL HISTORY

Numerous fasteners and hydraulic fittings were tightened during the first part of the test. The clutch switch sliding bar bent and was replaced five times during the test.

RECOMMENDATIONS

The AFMRC recommends that the manufacturer:

1. Supply a slow moving vehicle sign in accordance with ASAE Standards.
2. Modify the fertilizer metering system to eliminate the affect of slopes on rates.
3. Offer a fill auger as optional equipment.
4. Provide screens for the tank openings.
5. Modify the seed tank so emptying is more uniform during operation.
6. Provide a convenient method to clean large amounts of material from the tanks.
7. Improve the fertilizer clean out door seal to prevent moisture from entering.
8. Provide a convenient method for calibrating the application rate.
9. Modify the automatic clutch switch assembly to prevent failure during operation.

Manager: R.P. Atkins, P.Eng.
Technical Aide: Anthony Pickard
Technical Aide: Blaine Metzger

MANUFACTURER'S REPLIES TO RECOMMENDATIONS

The manufacturer states that with regards to recommendation number:

1. A mounting bracket for a slow moving vehicle sign is provided in accordance with ASAE Standards. In addition, the drill is equipped with warning lights; one red tail light and two amber lights.
2. Case IH will investigate how to reduce over application of fertilizer when travelling downhill on a 15 degree slope.
3. Fill auger is now available as optional equipment. This was announced to our dealers last January. The auger will also retrofit older machines.
4. A screen was used during early testing of this machine. Most users of the original test machines thought the screen was in their way and had it removed.
5. Holes have been added to the lower partition panels in the hopper for more uniform depletion of seed. All 1993 machines will have this change.
6. The fertilizer portion of the hopper has a drop bottom making it easy to empty all the fertilizer. An improved clean out system for seed is under review.
7. To protect against the corrosive effects of commercial fertilizers this hopper must be emptied at the end of the day and the fertilizer metering equipment must be cleaned. This is especially important in high humidity conditions. Adjust latches to make sure drop bottom fits tight against bottom of hopper.
8. Case IH will investigate a more convenient method of calibrating the application rate.
9. The slider bar should be free to slide inside the guide. Case IH is reviewing the tolerances on both parts.

GENERAL DESCRIPTION

The Case IH 8500 air hoe drill is a pneumatic seed and fertilizer applicator connected to the front of a three row hoe drill. The drill is available in a three section 33 ft (10.1 m) unit and a six section 45 ft (13.7 m) unit. Dual castor wheels on the mainframe and single castor wheels on the wings support the front of the drill. Gang press wheel assemblies support the back of the drill. Seed and fertilizer are placed in the furrows made by the Eagle Beak points and packed by the gang press wheels. Spring trip hoe openers are available with 7 or 10 in (178 or 254 mm) spacings. A 12 in (305 mm) spacing is also available on the 45 ft (13.7 m) unit. Seed depth is controlled by a depth collar on the left master cylinder. Adjusting the height of the 20 in (508 mm) steel press wheel assemblies level the unit front to back.

Seed is metered by externally fluted rollers and fertilizer is metered by star shaped feed wheels. The meters are ground driven through a series of chains and sprockets by the right applicator wheel. The meters are engaged by an electrical clutch. A switch mounted on the drill automatically engages the clutch when the drill is lowered into the ground. The clutch is also controlled by the monitor in the tractor cab.

The air stream produced by the centrifugal fan conveys the metered material through the distribution system. Venturis below each meter load the air streams. Seed and fertilizer are distributed together through 11 outlet vertical manifolds to the seed boots. Power to the fan is supplied by a hydraulic system. The hydraulic system is driven by the tractor power take off at 1000 rpm.

The monitoring system consists of seed and fertilizer shaft sensors, bin level sensors and a fan speed sensor. The monitor can also include an optional feature which detects any blockages in the individual seed tubes.

The test machine was 45 ft (13.7 m) wide and equipped with 77 spring trip openers spaced at 7 in (178 mm). Optional equipment on

the test unit included a blockage monitor, cushion press wheel gang attachments and 3 x 20 in (76 x 508 mm) convex steel press wheels. A tractor with a 1000 rpm power take-off and two remote hydraulics was required.

Detailed specifications for the Case IH 8500 are given in APPENDIX I and the location of major components shown in FIGURE 1.

SCOPE OF TEST

The Case IH 8500 air hoe drill was operated in the field conditions shown in TABLE 1 for 182 hours while seeding 3787 ac (1514 ha). The air drill was evaluated for quality of work, ease of operation and adjustment, power requirements, operator safety, and suitability of the operator's manual. The metering systems were tested in the laboratory for metering and distribution accuracy and the affect of field and machine variables on metering and distribution.

The machine evaluated by the Alberta Farm Machinery Research Centre (AFMRC) was configured as described in the General Description, FIGURE 1 and the Specifications section of this report. The manufacturer may have built different configurations of this machine before and after AFMRC tests. Therefore, when using this report, be sure to first check that the machine you are considering is the same as the one shown here. If not, assistance can be obtained from the manufacturer or AFMRC in determining how this new machine will perform compared to the one tested.

TABLE 1. Operating Conditions

MATERIAL	SOIL TYPE AND CONDITION	STONE CONDITIONS	FIELD AREA		HOURS
			ac	ha	
Barley	Silt Loam **	Occasional	513	205	20
Barley	Sandy Loam **	Occasional	886	354	36
Barley	Loam *	Moderate	94	38	5
Durum Wheat	Clay **	Occasional	328	131	15
Durum Wheat	Silt Loam **	Occasional	346	138	15
Spring Wheat	Loam **	Moderate	369	148	19
Canola	Sandy Loam **	Occasional	325	130	17
Winter Wheat	Silt Clay Loam *	Occasional	364	146	20
Winter Wheat	Clay Loam *	Occasional	205	82	12
Winter Wheat	Loam **	Occasional	121	48	6
Winter Wheat	Clay Loam **	Occasional	236	94	17
TOTALS			3787	1514	182
* Primary ** Secondary					

RESULTS AND DISCUSSION

QUALITY OF WORK

Penetration: Penetration of the Case IH 8500 with the spring trip hoe openers (FIGURE 2) was very good. Several of the fields encountered during the tests contained areas of hard soil or were prepared at shallow tillage depths.

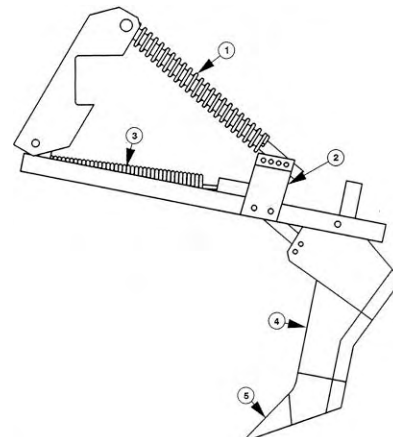

FIGURE 2. Spring-Trip Hoe Opener Assembly: (1) Compression Spring, (2) Depth Bracket, (3) Trip Spring, (4) Shank, and (5) Hoe Point Opener.

Uniform penetration across the width of the drill required proper levelling of the unit. The front castor wheels and packers provided adequate support for the drill. The six section frame allowed the drill to follow the contour of the land very well except in sharp gullies or hills.

The spring force was varied by changing the length of the spring. The depth of the hoe opener was also adjustable. Twelve spring positions were possible for the hoe opener. FIGURE 3 illustrates the minimum and maximum vertical force deflection curves.

The horizontal trip force of the shanks was 340 lb (1.5 kN).

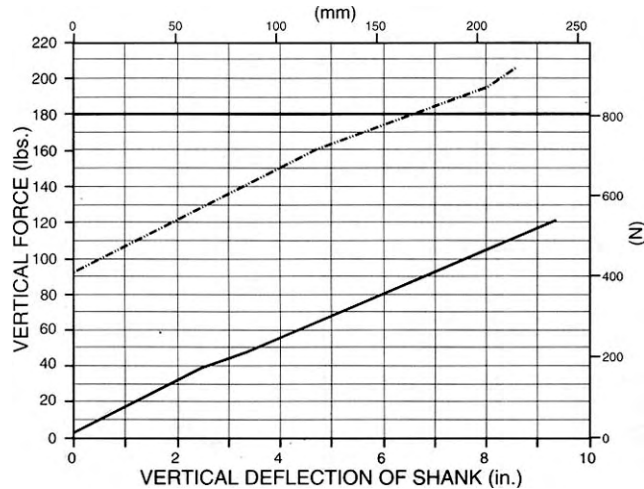

FIGURE 3. Minimum and maximum vertical force deflection curves for the hoe opener.

Seed and Fertilizer Placement: Seed and fertilizer placement of the Case IH 8500 was very good. Seed and fertilizer were placed together in furrows. The shanks were equipped with a tube type delivery seed boot assembly located directly behind the Eagle Beak point. The band width of the rows averaged 1.2 in (30 mm). Variation in seed and fertilizer depth was uniform when seeding in either tilled or untilled soil. Most seeds were placed within 0.4 in (10 mm) of the average seed depth of 2.3 in (58 mm).

The Case IH 8500 was stable and did not skew sideways in typical field conditions.

Soil Finishing: Soil finishing of the Case IH 8500 was very good. FIGURE 4 shows the soil surface after seeding into a previously tilled field. FIGURE 5 shows the soil surface after seeding into an untilled wheat stubble field. The majority of the stubble was left standing. Ridge depths left by the packer wheels ranged from 1.3 to 2.5 in (33 to 64 mm), depending on soil, operating speed and seed depth. The packing force was adequate for the soils and conditions encountered during the test.

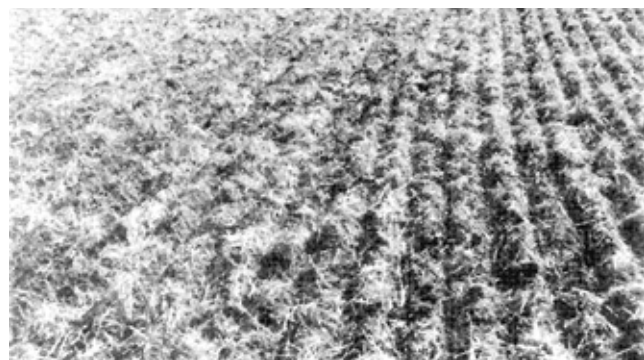

FIGURE 4. Soil surface after seeding into a previously tilled field.

Residue Clearance: Residue clearance of the Case IH 8500 was good. The three rows of hoe openers on a 21 in (533 mm) lateral spacing allowed good residue flow except in fields with high amounts of straw, high standing stubble or weed infestations.



FIGURE 5. Soil surface after seeding into an untilled Wheat stubble field.

Stony Conditions: Operation of the Case IH 8500 in stony conditions was very good. One seed boot was damaged during the test. Maximum trip height for the shank assembly ranged from 7 to 9 in (178 to 229 mm) depending on the compression spring setting.

Metering Accuracy: Metering accuracy of the Case IH 8500 was good. The seed metering rate was varied by lateral movement of the feed rolls, the shaft speed and the position of the metering gate. The fertilizer metering rate was varied by the gate opening above the star shaped wheels and the shaft speed. The calibration curves obtained by AFMRC and the manufacturer with wheat, barley, peas, canola and 11-51-0 fertilizer are given in FIGURES 6 to 10. Any difference between the calibration curves obtained by AFMRC and the manufacturer are probably due to different seed size, density and moisture content. The densities obtained by AFMRC and the manufacturer are indicated on the graphs.

The maximum fertilizer rate for 11-51-0 fertilizer was 191 lb/ac (214 kg/ha).

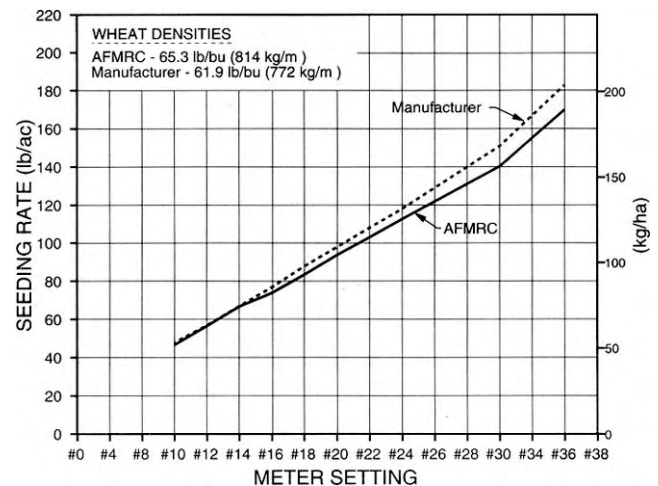

FIGURE 6. Metering accuracy with wheat.

Level of material in the tank, field roughness and variations in fan and ground speed had no significant effect on the metering rates. Operating the Case IH 8500 on uphill, downhill and side slopes affected the metering rate of 11-51-0 fertilizer as shown in FIGURE 11. Travelling downhill on a 15 degree slope caused an 84 percent increase in the metering rate of 11-51-0 fertilizer. On a 15 degree downhill slope 11-51-0 fertilizer flowed by the meters. Travelling on a 15 degree uphill slope caused a 23 percent decrease in the metering rate of 11-51-0 fertilizer. Travelling on a 15 degree left side slope caused a 11 percent decrease and travelling on a 15 degree right side slope caused a 15 percent increase in the metering rate of 11-51-0 fertilizer. The AFMRC recommends the manufacturer modify the fertilizer metering system to eliminate the affect of slopes on rates.

Travelling downhill on a 15 degree slope caused a 14 percent decrease in the metering rate of wheat. Side and uphill slopes had no significant affect on the metering rate of wheat.

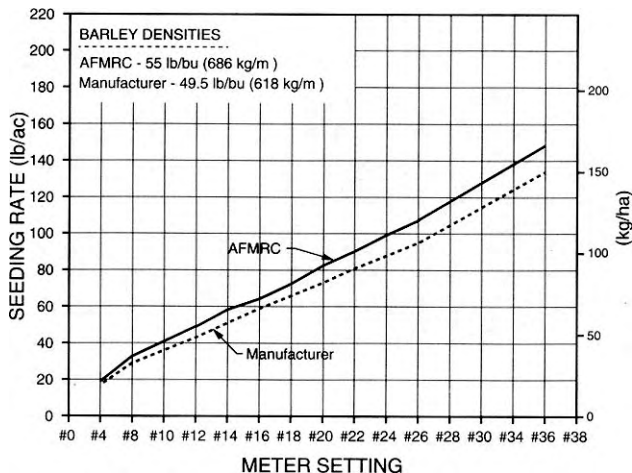

FIGURE 7. Metering accuracy with barley.

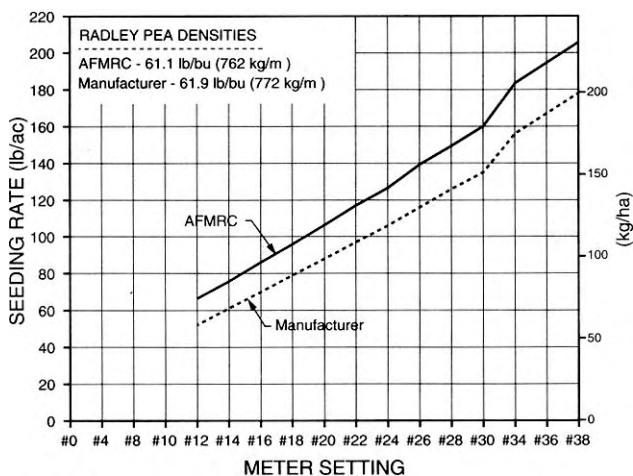

FIGURE 8. Metering accuracy with Radley peas.

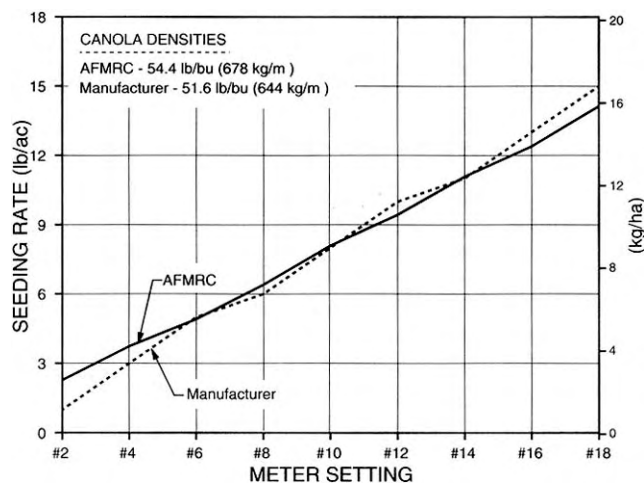

FIGURE 9. Metering accuracy with canola.

Distribution Uniformity: Uniformity of distribution of the application rates for the Case IH 8500 was good. FIGURES 12, 13 and 14 show the distribution uniformity with wheat, barley, Radley peas, 11-51-0 fertilizer and canola at various application rates.

Distribution was uniform with the coefficient of variation¹ (CV) ranging from 6.5 to 10.5 percent depending on the rate and material.

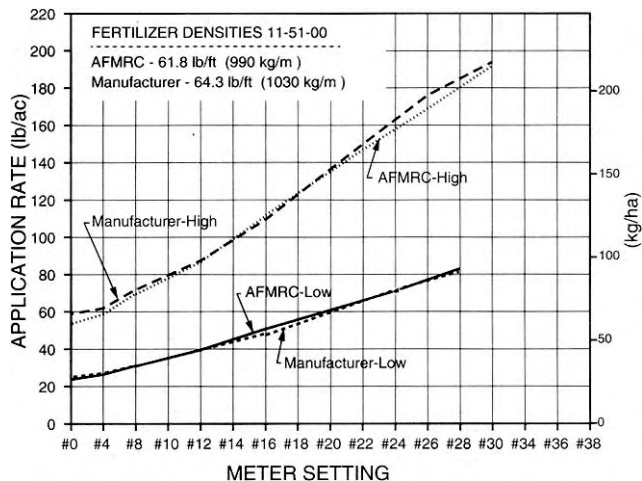

FIGURE 10. Metering accuracy with 11-51-0 fertilizer.

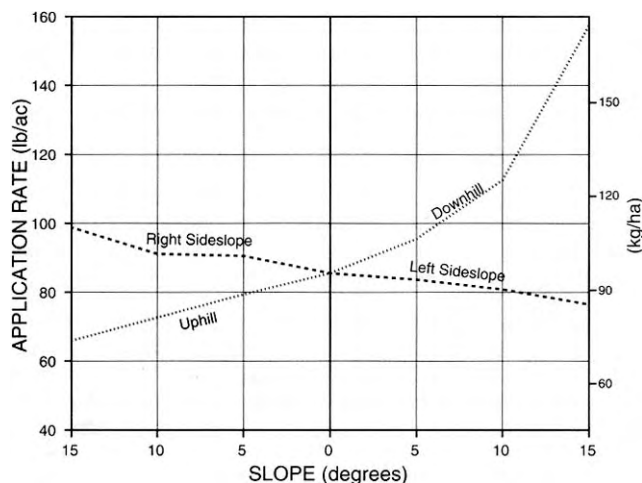

FIGURE 11. Variation in 11-51-0 fertilizer application rate with change in field slope.

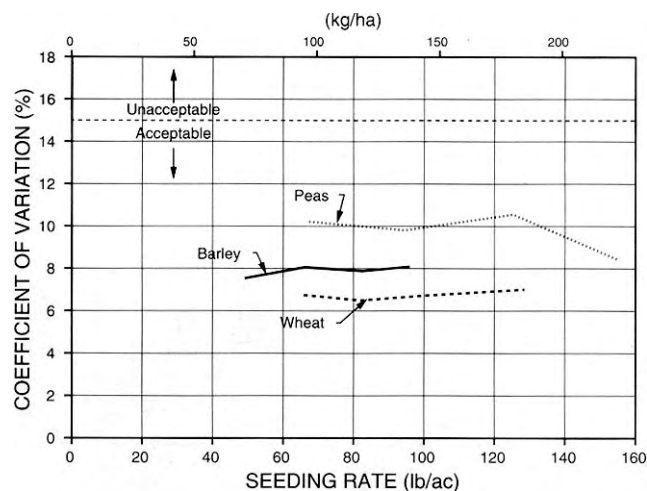

FIGURE 12. Distribution uniformity with wheat, barley and Radley peas over a range of seeding rates.

FIGURE 15 shows a typical seeding distribution uniformity pattern obtained with wheat at a seeding rate of 73 lb/ac (82 kg/ha). The seeding rate across the width of the unit varied from 62.1 to 85.1 lb/ac (69.6 to 95.4 kg/ha). This resulted in acceptable distribution uniformity with a CV of 6.6 percent.

FIGURE 16 shows a typical seeding distribution uniformity pattern obtained with canola at a seeding rate of 8 lb/ac (9 kg/ha). The application rate across the width of the air drill varied from 7.1 to 9.2 lb/ac (8 to 10.3 kg/ha). This resulted in acceptable distribution uniformity with a CV of 6.9 percent.

Level of material in the tank and changes in fan speed had no effect on the distribution uniformity. The distribution uniformity of 11-51-0 fertilizer was affected by slopes. Travelling on a 15 degree downhill slope increased the CV from 8.5 to 26.9 percent and travelling on a 15 degree right side slope increased the CV from 8.5 to 11.8 percent with 11-51-0 fertilizer.

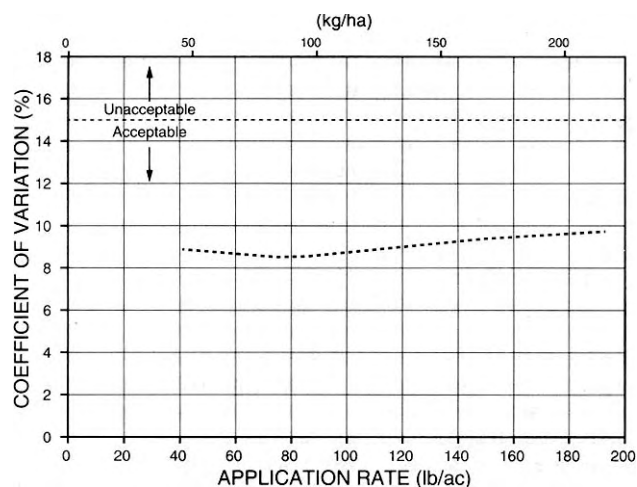

FIGURE 13. Distribution uniformity with 11-51-0 fertilizer over a range of application rates.

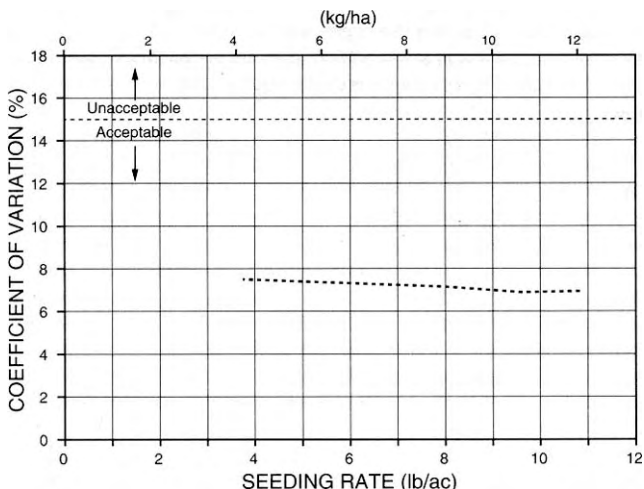

FIGURE 14. Distribution uniformity with canola over a range of seeding rates.

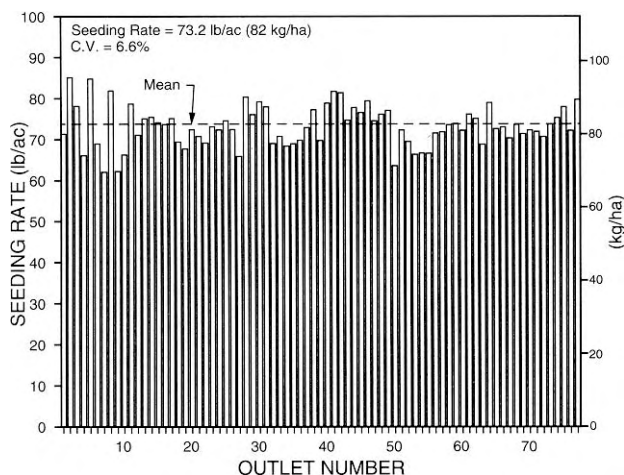

FIGURE 15. Distribution uniformity pattern with wheat at 73.2 lb/ac (82 kg/ha).

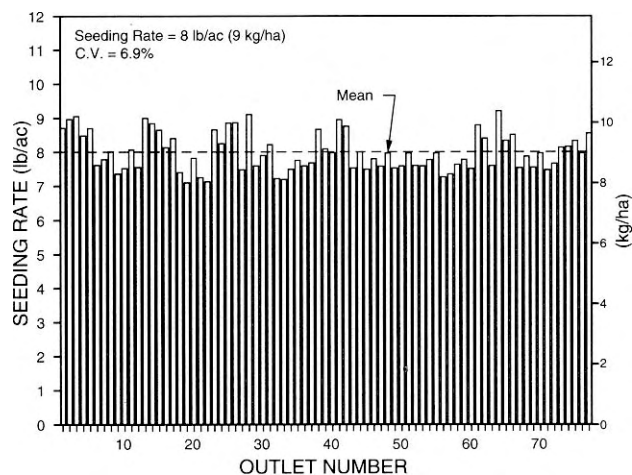

FIGURE 16. Distribution pattern with canola at 8 lb/ac (9 kg/ha).

Seed Handling: Seed handling was very good. Average damage in wheat and canola was less than 1 percent. Average damage in peas was 2.2 percent.

EASE OF OPERATION AND ADJUSTMENT

Maintenance: Ease of performing routine maintenance on the Case IH 8500 was fair. One hour was required to lubricate the 129 grease fittings as recommended in the owner's manual service schedule. Most of the grease fittings were accessible. Servicing the third row of shanks required a person to crawl underneath the drill. A level stick was provided to check the level of the hydraulic fluid.

Two people required two hours to replace the 77 Eagle Beak points.

Filling/Cleaning: Ease of filling and cleaning the Case IH 8500 was fair. A drill fill or grain auger was needed to fill the tanks. Short drill fills could not be used because the tank openings were located 7.3 ft (2.2 m) above ground level. The AFMRC recommends the manufacturer offer a fill auger as optional equipment.

The large 7.4 x 2.3 ft (2.3 x 1 m) tank opening allowed ample room for filling. An inside lid prevented spillage from one tank to the next during filling. The large single tank lid was easy to open. The tank openings were not covered by a screen to prevent blockages in the distribution system. Blockage of the delivery hoses occurred regularly during the test. The AFMRC recommends the manufacturer provide screens for the tank openings,

The seed tank capacity was 83 bu (3021 L) and the fertilizer tank capacity was 106 ft³ (3 m³) with the box partition in standard position. The tank capacities were adjusted by repositioning partitions. Optional partitions allow an all seed or fertilizer tank.

The centre of the seed tank emptied faster than the sides due to the position of the tank supports. The AFMRC recommends the manufacturer modify the seed tank so emptying is more uniform during operation.

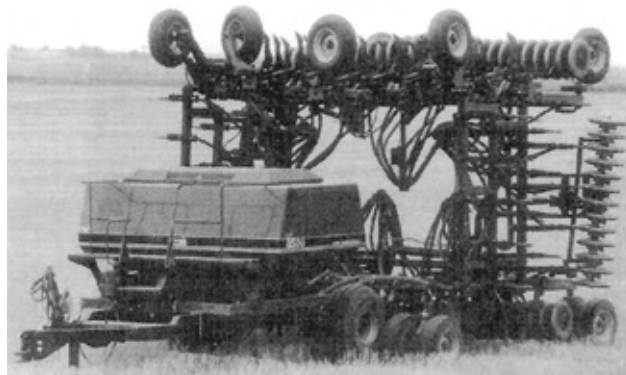

FIGURE 17. Transport position.

¹The coefficient of variation (CV) is the standard deviation of application rates from individual outlets expressed as a percent of the average application rate. A low CV represents uniform application whereas a high CV indicates non-uniform application. An acceptable variation for seeding or applying fertilizer is a CV value of not greater than 15 percent.

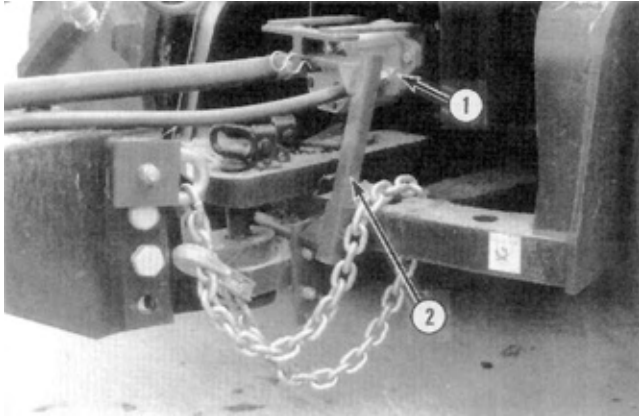

FIGURE 18. Hydraulic Pump: (1) Pump and (2) Mounting Kit.

Cleaning large amounts of seed or fertilizer out of the tanks was difficult. The seed tank had a clean out door on each end. Due to large supports in the seed tank only the ends of the tank were cleaned out easily. The clean out door at the bottom of the fertilizer tank was too wide for fertilizer to be caught with an auger or pail. The AFMRC recommends the manufacturer provide a convenient method to clean large amounts of material from the tanks.

Moisture leaked in and around the fertilizer meters causing fertilizer to cake after a rain. The AFMRC recommends the manufacturer improve the fertilizer clean out door seal to prevent moisture from entering.

Transporting: Ease of transporting the Case IH 8500 was very good. Five minutes were required to place the unit into transport position (FIGURE 17). Transport locks were provided for the wings. Safety struts were provided for the depth cylinders during transport.

Transport width of the unit was 19.6 ft (6 m), and transport height was 15 ft (4.6 m). The drill was equipped with transport hazard lights. No slow moving vehicle sign was supplied with the unit. The AFMRC recommends the manufacturer supply a slow moving vehicle sign in accordance with ASAE standards. Caution was required when transporting the unit on public roads. Ground clearance for the packers during transport was 5 in (127 mm). Ground clearance for the hoe openers during transport was 8 in (203 mm). Wheel tread width was 15.6 ft (4.8 m) which made the unit stable during transport.

Hitching to the Case IH 8500 was easy. Access to the hitch jack was good. The hitch tongue adjustment of 18 in (457 mm) was adequate during the test. The hydraulic pump was easily mounted to a tractor power take-off. A pump mounting kit was provided by the manufacturer and installed on the tractor drawbar (FIGURE 18) to prevent the pump from rotating during operation.

The Case IH 8500 required a tractor with two sets of remote hydraulics to control the depth and the wings. A tractor with a 1000 rpm power take-off was required to operate the hydraulic system for the centrifugal fan. A tractor with a seven pin electrical connection was needed to supply power to the monitor and the hazard lights. Visibility of the centre section of the air drill was blocked by the tank.



FIGURE 19. Application Rate Adjustment: (1) Seed and (2) Fertilizer.

Monitoring: Monitoring on the Case IH 8500 was very good. The electronic monitoring system monitored fan speed, front and rear tank levels, shaft rotation, and seed and fertilizer blockage. The digital display continuously showed fan speed in 10 rpm increments. The required fan speed was entered into the monitor and an alarm sounded when the fan speed increased by 5 percent or decreased by 10 percent. When the material in the front or rear tank dropped below the tank level sensor an alarm sounded and the monitor displayed the appropriate tank. The height of the tank level sensors were adjustable. If a metering shaft stopped turning the monitor displayed the appropriate shaft and an alarm sounded. An electric clutch was mounted on the main drive. The clutch was controlled by a switch on the monitor. The monitor also included an electronic acreage meter. The acre meter values averaged 4.1 percent high. An alarm sounded when one of the delivery tubes plugged and the monitor displayed which delivery tube and manifold was blocked.

Application Rates: Ease of setting the application rate for seed and fertilizer was very good. The seed rate was set by the adjustment lever (FIGURE 19), the shaft speed and the metering gates. For metering small seeds a slow shaft speed was obtained by switching two gears. The metering gates were adjustable to three positions.

The fertilizer rate was set by the adjustment lever and the shaft speed. When applying seed and fertilizer the fertilizer drive shaft required a 21 tooth sprocket. When applying only fertilizer at rates above 85 lb/ac (95 kg/ha) a 48 tooth sprocket replaced the 21 tooth sprocket.

The seed feed cups were aligned by loosening four cap screws on each cup and sliding the cups even with the flutes. The gap on the fertilizer gates was set to 5/16 in (8 mm) by loosening a set screw on each gate. Tank panels provided good access to the fertilizer gates.

The fan speed was set by adjusting a hydraulic flow control valve.

The Case IH 8500 was calibrated by removing the primary hoses behind the tank and attaching sacks to collect the material. The meters were engaged and the unit was operated a calculated distance and the sample weighed. The AFMRC recommends the manufacturer provide a convenient method for calibrating the application rate.

Depth Adjustment: Ease of setting the seeding depth was good. The seeding depth was set at the left master cylinder by adjusting the hydraulic depth stop. The unit was then levelled front to back by adjusting the height of the packer wheel assemblies. The assemblies were adjusted using a threaded rod (FIGURE 20). Setting the seed depth took 10 minutes. Individual opener depth was adjustable. Initial front to back levelling of the drill required adjustment of the front gauge wheel cylinder clevis rods and the linkage between the cart and drill frame.

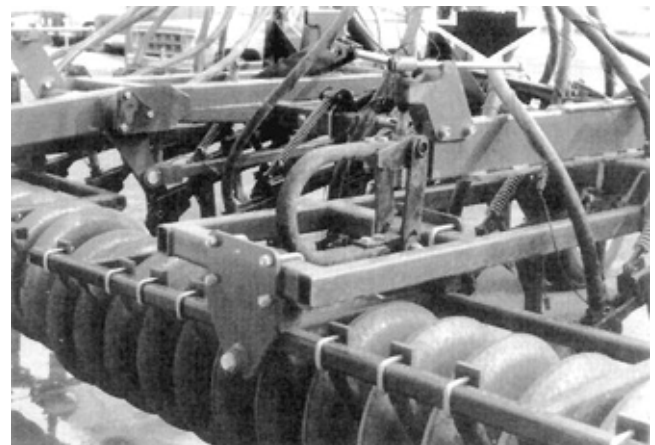

FIGURE 20. Depth adjustment for a packer wheel assembly.

POWER REQUIREMENTS

Draft Characteristics: Draft (drawbar pull) requirements depended on previous field preparations, soil texture, soil moisture content, ground speed and the amount of seed and fertilizer in the tanks.

Average draft at a 2 in (51 mm) seeding depth and at 5 mi/h (8 km/h), with full seed and fertilizer tanks ranged from 6585 lb (29.3 kN) to 9500 lb (42.3 kN) in secondary and primary conditions, respectively, for the 45 ft (13.7 m) air drill.

Tractor Size: The average tractor size needed to pull the test unit varied from 158 to 196 PTO hp (119 to 147 PTO kW).

Average power take-off horsepower requirements to run the hydraulic system ranged from 16 to 30 hp (12 to 23 kW).

The overall tractor size needed to operate the test unit varied from 188 to 226 PTO hp (141 to 170 PTO kW). These tractor sizes have been adjusted to include tractive efficiency and represent a tractor operating at 80 percent of maximum power take-off rating as determined by the Nebraska tractor tests or as presented by the tractor manufacturer. The tractor sizes given will have ample power reserves to operate in the stated conditions.

OPERATOR SAFETY

The Case IH 8500 was safe to operate if normal safety precautions were observed. A wide platform with railing, provided easy access to the tank opening. Safety struts were provided for the depth cylinders when the operator was working under the unit to grease the shanks or change the hoe points. Transport locks were provided for the wings and transport wheels. A safety tow chain was provided. Transport lights were mounted at the rear of the drill. As mentioned in the transport section, a slow moving vehicle sign was not provided. Tire loads did not exceed the Tire and Rim Association maximum load ratings for the recommended tire inflation pressure and transport speed for the drill. The maximum load rating for the tank tires would be exceeded if transported full of grain at speeds higher than 10 mph (16 km/h).

The noise level around the drill with the centrifugal fan operating was high so ear protection was used. The operator noise level in the modern tractor cab was unaffected from the centrifugal fan.

OPERATOR'S MANUAL

The operator's manual for the Case IH 8500 was very good. The manual contained information on safety, preparation, adjustments, operation and maintenance. The calibration charts included density and rates in both Imperial and SI units. The location of all the safety decals were illustrated. The manual was clearly written with photographs and illustrations for explanations. The manual was stored on the drill in a weather resistant container.

MECHANICAL HISTORY

The Case IH 8500 was operated for 182 hours while seeding 3787 ac (1514 ha). The intent of the test was the evaluation of functional performance. An extended durability evaluation was not conducted. TABLE 2 outlines the mechanical problems that did occur during the functional testing.

TABLE 2. Mechanical History.

ITEM	OPERATING HOURS	EQUIVALENT FIELD AREA	
		ac	ha
Tightened numerous nuts, bolts and fittings		Throughout the Test	
Clutch linkage rod assembly failed several times		Throughout the Test	
Damaged delivery hose at	0.5	10	4
Replaced the shaft key on the hydraulic pump at	2.0	40	16
Replaced lost seed boot at	8.0	165	66
Replaced bent seed boot at	56.0	1075	430
Repaired master cylinder plunger rod at	71.0	1700	688
Tighten press wheel assembly at	104.0	2374	950
Reinstalled LH tank and drill connecting pin	153.0	3311	1324
Hydraulic pump shaft failed; replaced pump at	162.0	3620	1448
Repaired LH tank and drill connection at		End of Test	

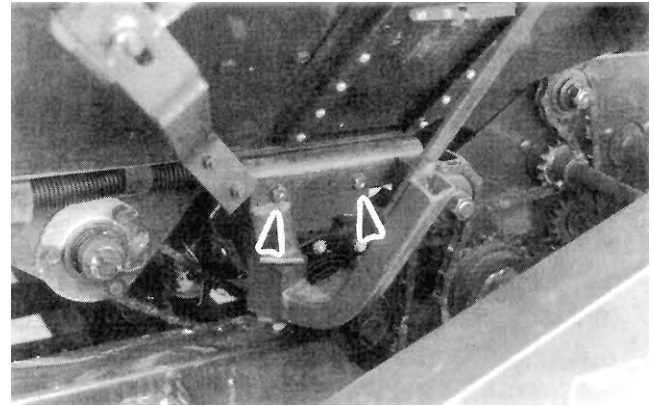

FIGURE 21. Loose seed metering bolts.

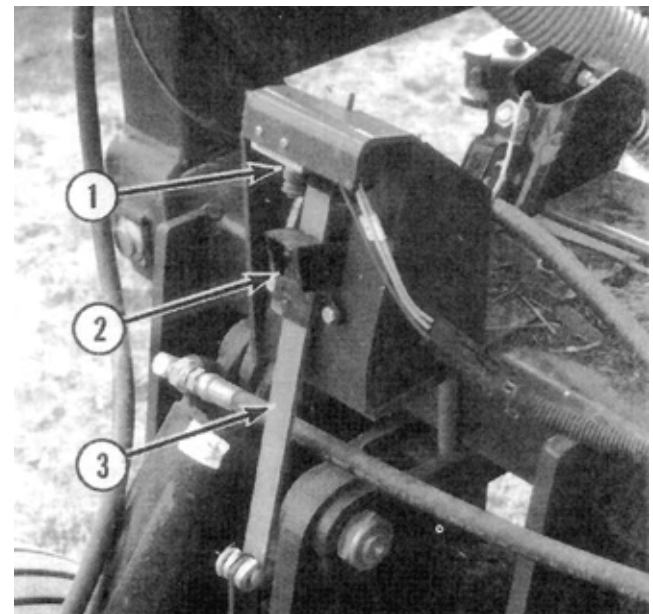

FIGURE 22. Automatic Clutch Switch Assembly: (1) Electric Switch, (2) Mechanical Activator, and (3) Sliding Bar.

DISCUSSION OF MECHANICAL PROBLEMS

Loose Fasteners: Numerous fasteners and hydraulic fittings were tightened on the test unit during the first part of the test. Two bolts (FIGURE 21) that fasten the seed adjustment lever to the tank were retightened at the end of the test. The loose bolts caused a variation in application rates.

Automatic clutch switch assembly: The automatic clutch switch assembly (FIGURE 22) turned the metering clutch on and off when the air drill was lowered or raised. The clutch switch sliding bar bent and was replaced five times during the test. The bending of the bars was caused by jamming of the assembly. The AFMRC recommends the manufacturer modify the automatic clutch switch assembly to prevent failure during operation.

APPENDIX I SPECIFICATIONS

MAKE:	Case IH	
MODEL:	8500 Air Hoe Drill	
SERIAL NUMBER:	JAG0135089	
- tank	JAG0138131	
- drill		
MANUFACTURER:	JI Case Canada A Division of Tenneco Canada Inc. 3350 S. Service Road Burlington, Ontario L7N 3M5	
DISTRIBUTOR:	JI Case Canada A Division of Tenneco Canada Inc. 240 Henderson Drive P.O. Box 5051 Regina, Saskatchewan S4P 3M3 Phone: (306) 924-1637	
DIMENSIONS:	<u>Field Position</u>	<u>Transport Position</u>
- width	44.9 ft (13.7 m)	19.6 ft (6.0 m)
- length	31.4 ft (9.6 m)	31.4 ft (9.6 m)
- height	8.1 ft (2.5 m)	15.0 ft (4.6 m)
- effective seeding width	44.9 ft (13.7 m)	-
- ground clearance		
- packers		5.0 in (127 mm)
- shanks		8.0 in (203 mm)
- wheel tread		15.6 ft (4.8 m)
METERING SYSTEM:		
- seed		
- type	external fluted feed rolls	
- number of meters	7	
- drive	chain drive	
- adjustment	a lever controlling the exposed feed roll length, low and high shaft speed and positioning of the feed gate	
- fertilizer		
- type	star shaped feed metering wheels rotating on a vertical shaft	
- number of meters	7	
- drive	chain drive	
- adjustment	lever controlling feed gate height and high and low shaft speed	
- airstream loading	venturi	
- transfer to openers	pneumatic conveyance through manifold and delivery hoses	
- hose sizes		
- secondary	2.5 in (64 mm) ID	
- delivery	1.4 in (36 mm) ID	
TANK CAPACITIES:		
- seed	83 bu (3021 L)	
- fertilizer	106 ft ³ (3 m ³)	
FAN:		
- type	centrifugal	
- operating range	2800 to 4000 rpm	
- drive	hydraulic pump mounted on 1000 rpm PTO	
OPENERS:		
- type	spring-trip hoe	
- point	Eagle Beak	
- point width	1.4 in (36 mm)	
- number	77	
- spacing	7 in (178 mm)	
- vertical clearance	29 in (737 mm)	
- number of rows	3	
- distance between rows	28 in (711 mm)	
- opener bolt size	0.25 x 1.25 in (6 x 32 mm)	
PRESS WHEELS:		
- type	steel convex	
- diameter	20 in (508 mm)	
- width	3 in (76 mm)	
- number	77 (five sets of 13 and one set of 12)	
- spacing	7 in (178 mm)	
DRILL HITCH:		
- vertical adjustment	18 in (457 mm), 3 adjustments	
DEPTH CONTROL:		
	depth collar on hydraulic cylinder with a shut off valve and threaded rod on each press wheel assembly	
FRAME:		
- number of sections	6	
- cross sections	4 x 4 in (102 x 102 mm) 3 x 4 in (76 x 102 mm)	

WHEELS (tire size):		
- tank	2 - 19L- 16.1, 8 ply	
- front drill wheels	2- 9.5L- 15, 6 ply	
- back drill wheels	6- 9.5L- 15, 6 ply	
LEVELLING:	adjusting reds on the gauge wheel cylinders and adjusting screws on each press wheel assembly	
TRANSPORT LOCKS:	safety struts for the hydraulic cylinders on the transport wheels and safety pins for the wings	
WEIGHTS:		
- applicator	<u>Tanks Empty</u>	<u>Tanks Full of Wheat</u>
- hitch	1470 lb (667 kg)	3890 lb (1766kg)
- left wheel	2780 lb (1261 kg)	5665 lb (2570 kg)
- right wheel	2780 lb (1261 kg)	5665 lb (2570 kg)
- seeder	<u>Field Position</u>	<u>Transport Position</u>
- left wing	-	4420 lb (2005 kg)
- right wing	-	4420 lb (2005 kg)
- centre frame	15700 lb (7124 kg)	6880 lb (3122 kg)
TOTALS		
- TANKS EMPTY	22730 lb (10313 kg)	
- TANKS FULL OF WHEAT	-	30940 lb (14038 kg)
NUMBER OF CHAIN DRIVES:	5	
NUMBER OF SEALED BEARINGS:	9 (metering system)	
NUMBER OF LUBRICATION POINTS:	129	
NUMBER OF HYDRAULIC CYLINDERS:	depth - 8, wings - 4	
OPTIONS INCLUDED ON TEST MACHINE:	45 ft (13.7 m) wide, 7 in (178 mm) row spacing, blockage monitor, 3 x 20 in (76 x 508 mm) convex steel press wheels, cushioned press wheel gang attachments	
OTHER AVAILABLE OPTIONS:	standard monitor, 3 in (76 mm) shovels, 5 in (127 mm) shovels, shear trip hoe opener, press wheel 3 x 20 in (76 x 508 mm) V steel, press wheels 3 x 20 in (76 x 508 mm) rubber, press wheels 2 x 20 in (51 x 508 mm) steel convex, all seed capacity partitions, all fertilizer capacity panels, 10 and 12 in (254 and 305 mm) row spacing, 33 feet (10 m) operating width with 7 and 10 in (178 and 254 mm) spacing openers	

APPENDIX II MACHINERY RATINGS

The following rating scale is used in Alberta Farm Machinery Research Centre Evaluation Reports.

- Excellent
- Very Good
- Good
- Fair
- Poor
- Unsatisfactory

SUMMARY CHART

CASE IH 8500 AIR HOE DRILL

RETAIL PRICE:	\$77,862.00 3,825.00 2,349.00 \$84,036.00	Standard Equipment: Case IH 8500 Air Hoe Drill, 45 ft (13.7 m), with 7 in (178 mm) spring hoe spacing Optional Equipment: Blockage monitor Optional Equipment: 3 x 20 in (76 x 508 mm) convex steel press wheels Retail Price: June, 1993 f.o.b. Hamilton, Ontario
QUALITY OF WORK:		
<ul style="list-style-type: none"> - penetration - seed and fertilizer placement: - soil finishing - residue clearance - metering accuracy - distribution uniformity 		<ul style="list-style-type: none"> very good; openers penetrated hard soil very good very good; left majority of the stubble standing in primary conditions good; plugged in fields with high amounts of straw good; fertilizer rates were affected by changes in slope good; CV's ranged from 6.5 to 10.5 percent
EASE OF OPERATION AND ADJUSTMENT:		
<ul style="list-style-type: none"> - maintenance - filling/cleaning - transporting - monitoring - application rates - depth adjustment 		<ul style="list-style-type: none"> fair; one hour required to service 129 grease fittings daily fair; filling required use of auger or drill fill, difficult to clean out large amounts very good; five minutes to place in transport position very good; bin level, shaft rotations, fan speed and seed tube blockage sensors supplied very good; easy to adjust good; 10 minutes to set the depth
POWER REQUIREMENTS:		varied from 188 PTO hp (141 PTO kW) to 226 PTO hp (170 PTO kW)
OPERATOR SAFETY:		safe; platform with hand railings provided
OPERATOR'S MANUAL:		very good; clearly written
MECHANICAL HISTORY:		the clutch switch linkage failed several times



**ALBERTA
FARM
MACHINERY
RESEARCH
CENTRE**

3000 College Drive South
Lethbridge, Alberta, Canada T1K 1L6
Telephone: (403) 329-1212
FAX: (403) 329-5562

<http://www.agric.gov.ab.ca/navigation/engineering/afmrc/index.html>

Prairie Agricultural Machinery Institute

Head Office: P.O. Box 1900, Humboldt, Saskatchewan, Canada S0K 2A0
Telephone: (306) 682-2555

Test Stations:

P.O. Box 1060

Portage la Prairie, Manitoba, Canada R1N 3C5

Telephone: (204) 239-5445

Fax: (204) 239-7124

P.O. Box 1150

Humboldt, Saskatchewan, Canada S0K 2A0

Telephone: (306) 682-5033

Fax: (306) 682-5080