

EROSION AND SEDIMENT CONTROL MANUAL



**Government
of Alberta** ■
Transportation

June 2011

**ALBERTA TRANSPORTATION
EROSION AND SEDIMENT CONTROL MANUAL**

THIS PAGE LEFT BLANK INTENTIONALLY.

VERSION HISTORY

| Version No. | Date | Description |
|--------------------|-------------|---|
| 1 | May 2003 | Updates/Edits/Revisions to Design Guidelines (March 27, 2003 Paper Publication) for Erosion and Sediment Control for Highways |
| 1a | March 2009 | New BMPs added to the Guidelines |
| 2 | March 2011 | Revision Update to Entire Erosion and Sediment Control Manual |
| | | |
| | | |
| | | |
| | | |
| | | |
| | | |

THIS PAGE LEFT BLANK INTENTIONALLY.

PREFACE

This document provides guidelines for analysis, design, construction, and maintenance of erosion and sediment control structures for highway construction projects. This document was developed with the intent that it would provide a convenient and comprehensive resource and a rational basis for the design of erosion and sediment control structures. It is intended primarily for use by design consultants but also provides valuable information for contractors and field personnel. It is intended to assist and provide direction in the analysis and design of erosion and sediment control structures, but is not intended to preclude innovative or alternative designs.

A general review of all sections and appendices within the manual was completed. Major updates from the first edition include:

- Provide a more thorough description of Temporary and Permanent Erosion Control Plan;
- Updating the list of Best Management Practices (BMPs) in Appendix C; and
- Added Streambank Applications to the list of BMPs.

Continuing comment is essential to the regular updating of this document and any feedback is welcome. Periodic updates and revisions will be undertaken in response to user feedback, changes in technology, regulatory requirements and many other factors. The most current version of this document will be posted on the Alberta Transportation (AT) website (www.transportation.alberta.ca/686.htm). Inquiries and comments may be sent to the Director of Geotechnical and Materials Services, Technical Standards Branch, Alberta Transportation, 4999-98 Avenue, Edmonton, Alberta, T6B 2X3.

Much appreciation is expressed to all those who have contributed to the development of this document. Special thanks are expressed to EBA, A Tetra Tech Company (EBA) who was given the task of developing and updating the document. Thanks are also expressed to members of the Consulting Engineers of Alberta (CEA), Alberta Roadbuilders and Heavy Construction Association (ARHCA) and staff of Alberta Transportation who were involved with development and updating of the document and review of the draft versions.

THIS PAGE LEFT BLANK INTENTIONALLY.

TABLE OF CONTENTS

| | | |
|------------|--|------------|
| 1.0 | INTRODUCTION | 1-1 |
| 1.1 | Objectives..... | 1-1 |
| 2.0 | REGULATORY REQUIREMENTS | 2-1 |
| 2.1 | Federal..... | 2-1 |
| 2.1.1 | Navigable Waters Protection Act..... | 2-1 |
| 2.1.2 | Fisheries Act..... | 2-1 |
| 2.2 | Provincial..... | 2-2 |
| 2.2.1 | Environmental Protection and Enhancement Act (EPEA)..... | 2-2 |
| 2.3 | Due Diligence..... | 2-2 |
| 3.0 | EROSION AND SEDIMENT CONTROL MANAGEMENT STRATEGY | 3-1 |
| 3.1 | Alberta Transportation Requirements..... | 3-1 |
| 3.1.1 | Consultant Responsibility – Permanent Erosion and Sediment Control Plan..... | 3-1 |
| 3.1.2 | Contractor Responsibility – ECO Plan..... | 3-1 |
| 3.1.3 | Consultant's Qualification to Design and Audit..... | 3-1 |
| 3.2 | Overview of Preparation of Erosion and Sediment Control Plans..... | 3-1 |
| 4.0 | EROSION AND SEDIMENT PROCESS | 4-1 |
| 4.1 | Mechanics of Erosion..... | 4-1 |
| 4.2 | Sedimentation..... | 4-1 |
| 4.3 | Types of Water Erosion..... | 4-1 |
| 4.4 | Factors Affecting Erosion..... | 4-2 |
| 4.4.1 | General..... | 4-2 |
| 4.4.2 | Climate..... | 4-2 |
| 4.4.3 | Soil Characteristics..... | 4-3 |
| 4.4.4 | Soil (Vegetative) Cover..... | 4-7 |
| 4.4.5 | Topography..... | 4-8 |
| 5.0 | SITE ASSESSMENT | 5-1 |
| 5.1 | General..... | 5-1 |
| 5.1.1 | Review of Construction Drawings..... | 5-1 |
| 5.1.2 | Geotechnical Investigation Reports..... | 5-1 |
| 5.1.3 | Aerial Photography/Imagery..... | 5-2 |
| 5.1.4 | Surficial Geology Maps..... | 5-2 |
| 5.1.5 | Vegetative Cover Maps..... | 5-3 |
| 5.1.6 | Floodplain Information..... | 5-3 |
| 5.1.7 | Site Inspection..... | 5-4 |
| 5.1.8 | Referrals with Regulatory Agencies..... | 5-4 |
| 6.0 | SITE EROSION POTENTIAL AND EVALUATION..... | 6-1 |
| 6.1 | General..... | 6-1 |
| 6.2 | Revised Universal Soil Loss Equation (RUSLE)..... | 6-1 |
| 6.2.1 | Rainfall Factor, R..... | 6-2 |
| 6.2.2 | Soil Erodibility Factor, K..... | 6-3 |
| 6.2.2.1 | Estimation of K..... | 6-3 |

TABLE OF CONTENTS

| | | |
|-------------|--|-------------|
| 6.2.2.2 | Soil Erodibility Adjustment Factor (\emptyset_K)..... | 6-4 |
| 6.2.3 | Topographic Factor, LS..... | 6-5 |
| 6.2.3.1 | Estimation of LS..... | 6-5 |
| 6.2.3.2 | Topographic Adjustment Factor (\emptyset_{LS})..... | 6-6 |
| 6.2.4 | Vegetation and Management Factor, C..... | 6-7 |
| 6.2.5 | Support Practice Factor, P (Practice Factor)..... | 6-7 |
| 6.3 | Empirical Method for Sediment Storage/Impoundment..... | 6-7 |
| 6.4 | Examples for Estimating Site Erosion Potential..... | 6-8 |
| 6.5 | Site Evaluation..... | 6-8 |
| 6.5.1 | Slope Analysis Summary..... | 6-8 |
| 6.5.2 | Drainage Analysis Summary..... | 6-9 |
| 6.5.3 | Site Hazard Classification..... | 6-9 |
| 6.5.4 | Connectivity to Downstream Aquatic Resources..... | 6-10 |
| 7.0 | EROSION AND SEDIMENT CONTROL METHODS..... | 7-1 |
| 7.1 | General..... | 7-1 |
| 7.1.1 | Temporary and Permanent Control Measures..... | 7-1 |
| 7.2 | Procedural BMPs and Planning Strategy..... | 7-2 |
| 7.2.1 | Understanding the Practice of Erosion and Sediment Control (ESC) as a Whole System..... | 7-2 |
| 7.3 | Water Management BMPs..... | 7-5 |
| 7.4 | Erosion Control BMPs..... | 7-7 |
| 7.5 | Sediment Control BMPs..... | 7-15 |
| 7.6 | Selection Considerations for Bio-engineering Methods..... | 7-21 |
| 8.0 | SELECTION OF BMP FOR EROSION AND SEDIMENT CONTROL..... | 8-1 |
| 8.1 | Preliminary Tasks..... | 8-1 |
| 8.2 | Guidelines for Selecting Appropriate Erosion and Sediment Control Measures..... | 8-1 |
| 8.3 | Construction Phase Activities..... | 8-3 |
| 8.4 | Selection of Best Management Practice (BMP) According to Construction Activity... | 8-4 |
| 9.0 | THE PERMANENT EROSION AND SEDIMENT CONTROL PLAN (PESC PLAN)..... | 9-1 |
| 9.1 | General..... | 9-1 |
| 9.2 | Consultant Responsibility..... | 9-1 |
| 9.3 | PESC Plan Documentation..... | 9-1 |
| 9.4 | Design and Construction Drawings..... | 9-2 |
| 9.5 | Contract Special Provisions..... | 9-2 |
| 9.6 | Site Inspection During Construction..... | 9-2 |
| 9.7 | Inspection and Incident Records..... | 9-2 |
| 9.8 | As-Built Drawings and Project Records..... | 9-3 |
| 9.9 | Post Construction..... | 9-3 |
| 10.0 | THE TEMPORARY EROSION AND SEDIMENT CONTROL PLAN (TESC PLAN)..... | 10-1 |
| 10.1 | General..... | 10-1 |
| 10.2 | Contractor's Responsibility..... | 10-1 |
| 10.3 | TESC Plan Documentation..... | 10-1 |

TABLE OF CONTENTS

| | | |
|-------------|---|-------------|
| 10.4 | Site Inspection During Construction..... | 10-1 |
| 10.5 | Shutdown Considerations..... | 10-2 |
| 10.6 | Emergency Response Plan | 10-2 |
| 10.7 | Inspection and Incident Reports | 10-2 |
| 10.8 | Post Construction | 10-2 |
| 11.0 | GUIDELINES FOR ESTIMATING RUNOFF FROM SMALL WATERSHEDS AND DESIGN OF OPEN CHANNELS | 11-1 |
| 11.1 | General | 11-1 |
| 11.2 | Estimating Runoff from Small Watersheds..... | 11-1 |
| 11.3 | Design of Open Channels..... | 11-1 |
| 12.0 | GUIDELINES FOR THE DESIGN OF SEDIMENT CONTAINMENT..... | 12-1 |
| 12.1 | General | 12-1 |
| 12.2 | Containment Systems (Type I, II and III)..... | 12-1 |
| 12.3 | Design Considerations..... | 12-3 |
| 12.4 | Design Examples..... | 12-3 |
| 13.0 | REFERENCES | 13-1 |

TABLE OF CONTENTS
LIST OF TABLES

| | <u>Page #</u> | |
|------------|---|------|
| Table 6.1 | Site Hazard Classification (RUSLE-FAC *) | 6-9 |
| Table 6.2 | Connectivity Rating to Aquatic Resources | 6-10 |
| Table 7.1 | Procedural BMPs and Planning Strategies for ESC Plan | 7-3 |
| Table 7.2 | Surface Water Management BMPs for ESC Plan | 7-6 |
| Table 7.3 | Erosion Control Measures – Source Control | 7-8 |
| Table 7.4 | Erosion Control Measures - Runoff Control | 7-12 |
| Table 7.5 | Sediment Control Measures | 7-17 |
| Table 8.1 | Required Levels of Erosion and Sediment Control | 8-2 |
| Table 8.2 | Application for BMPs Based on Construction Activities | 8-5 |
| Table 8.3 | BMPs for Streambank Applications | 8-6 |
| Table 8.4 | BMPs for Streambank Applications Based on Erosion Process | 8-7 |
| Table 12.1 | Containment System Types | 12-2 |

LIST OF FIGURES

| | <u>Page #</u> | |
|-------------|---|------|
| Figure 3.1 | Alberta Transportation Management Strategy for Erosion and Sediment Control | 3-2 |
| Figure 4.1 | Types of Water Erosion | 4-2 |
| Figure 4.2 | Soil Texture Nomograph and Soil Erodibility Rating | 4-4 |
| Figure 4.3 | Unified Soil Classification System (modified by PFRA) | 4-5 |
| Figure 4.4 | Grain Size Description According to Various Engineering Soil Classification Systems | 4-6 |
| Figure 4.5 | Estimated Runoff from Precipitation for Different Soil Types | 4-7 |
| Figure 8.1 | Steps in Preparing an Erosion and Sediment Control Plan | 8-1 |
| Figure 12.1 | Type I and II Typical Sediment Containment Systems | 12-4 |
| Figure 12.2 | Type II Sediment Containment System (Sediment Trap) - Excavation Option | 12-5 |

LIST OF APPENDICES

| | |
|------------|---|
| Appendix A | Example Soil Test Data for Different Parts of Alberta and Respective Soil Erodibility Rating - Preliminary Assessment |
| Appendix B | Supporting Information for RUSLE |
| Appendix C | Erosion and Sediment Control Best Management Practices (BMPs) |
| Appendix D | Inspection and Maintenance Form, ESC Plan Development Checklist, ECO Plan Framework Checklist |
| Appendix E | Establishing Runoff from Small Watersheds |
| Appendix F | Guidelines for the Design of Open Channels |
| Appendix G | Sediment Containment System Design Rationale |
| Appendix H | Design Example |

1.0 INTRODUCTION

Erosion and sedimentation are naturally occurring processes of loosening and transport of soil through the action of wind, water or ice and its subsequent deposition. However, construction activities can result in accelerated rates of erosion and sedimentation where soil surfaces are exposed and initially not revegetated. If left uncontrolled, these processes may result in an adverse impact to the environment, such as degradation of surface water quality, damage to adjacent land and degradation of aquatic habitat. Erosion and sediment control techniques are activities or practices, or a combination of practices that are designed to protect an exposed soil surface, to prevent or reduce the release of sediment to environmentally sensitive areas, and to promote revegetation as soon as possible.

The purpose of this document is to provide guidelines and standard procedures so that construction and maintenance activities are carried out in a manner to minimize erosion and sediment transport particularly where there are potential impacts to environmentally sensitive areas.

In this document, the process of sedimentation control is synonymous to sediment control.

1.1 Objectives

The objectives of this document are:

- Provide reference to the regulatory requirements related to sediment control;
- Clarify the roles and responsibilities of the owner (Alberta Transportation (AT)), their consultants, and the contractors involved in a construction project;
- Provide guidelines and standard procedures for selecting, designing and implementing erosion and sediment control measures for highway construction and maintenance;
- Provide details of erosion and sediment control measures commonly used on Alberta highway construction sites as well as their applications and limitations; and
- Provide a platform to assist AT in educating consultants and contractors with regards to erosion and sediment control.

This document is intended for use in the design, construction and maintenance of erosion and sediment control measures for terrestrial (land-based) highway infrastructure. The information, guidelines and reference material presented in this document is intended to supplement the experience and judgement of the individual or firm responsible for preparing an erosion and sediment control plan. **This document is not applicable for instream works.** The guidelines presented in the AT document "Fish Habitat Manual" (AT, 2009) are recommended for instream works.

A Field Guide titled "Erosion and Sediment Control Field Guide" compliments this document.

THIS PAGE LEFT BLANK INTENTIONALLY.

2.0 REGULATORY REQUIREMENTS

There are a number of federal and provincial acts and regulations governing activities that cause, or can cause harm to the environment, including construction projects that result in erosion and/or sedimentation. Regulatory agencies also publish codes of practice, guidelines and standards that set out requirements for undertaking certain types of activities. Most legislation and other types of regulatory tools make reference to preventing the release of harmful or deleterious substances, including silt, to the environment.

Fisheries and Oceans Canada (DFO) operates in Alberta to enforce the relevant federal legislation. Alberta Environment enforces relevant provincial legislation in collaboration with DFO federal legislation.

Brief overviews of the major acts are presented below. More thorough descriptions are provided in the AT Environmental Management System (EMS) Manual at <http://www.transportation.alberta.ca/2643.htm>.

2.1 Federal

2.1.1 Navigable Waters Protection Act

The *Navigable Waters Protection Act* applies to in-stream work involving construction or placement in, on, over, under, through, or across any navigable water. This Act contains prohibitions related to the deposition of materials (e.g., sediment) in navigable waters.

2.1.2 Fisheries Act

The *Fisheries Act* exists to protect fish and fish habitat. The Fisheries Act prohibits any person from depositing or permitting the deposit of a deleterious substance of any type in water frequented by fish or in any place under any conditions where the deleterious substance may enter such water. Silt is among the most common types of deleterious substance.

The Act creates a duty to report the deposit of a deleterious substance, where a deposit occurs in water frequented by fish and results or may result in damage to fish or fish habitat.

Persons are also required to take all reasonable measures to prevent any deposit or to counteract, mitigate or remedy any adverse effects that result or may result from a deposit.

The Act prohibits the carrying on of any work or undertaking that results in the harmful alteration, disruption or destruction of fish habitat, unless authorized by the Minister.

Additional sections of the Fisheries Act relevant to roadway construction activities require that fishways be maintained, fish passage be kept free, and that sufficient water flow is maintained in watercourses.

2.2 Provincial

2.2.1 Environmental Protection and Enhancement Act (EPEA)

The *Environmental Protection and Enhancement Act* exists to support and promote the protection, enhancement and wise use of the environment. Under the Act, it is prohibited to release or permit the release of a substance into the environment in an amount, concentration or level or at a rate of release that is in excess of an approval or a regulation that causes or may cause a significant adverse effect.

One of the definitions of substance is "any matter that is capable of becoming dispersed in the environment". This includes erosion of soil particles resulting from construction activities.

Under the Act, there is also a duty to take remedial measures "where a substance is released into the environment that has caused, is causing or may cause an adverse effect".

Under the Act, "a person who releases or causes or permits the release of a substance into the environment that may cause, is causing or has caused, an adverse effect shall, as soon as that person knows or ought to know of the release, report it".

2.3 Due Diligence

Most environmental legislation provides for "due diligence" as a defence to the majority of environmental offences.

AT is working to meet its due diligence obligations with respect to erosion and sediment control by taking the following steps:

- Publication of this document for its implementation in the highway construction industry by both contractors and consultants;
- Offering training workshops on the proper use of this document;
- Increasing awareness of erosion pollution adverse impacts, regulatory requirements and penalties for contravention; and
- Enforcing the proper use of best management practices for erosion and sediment control for the highway construction industry through contracts and training.

3.0 EROSION AND SEDIMENT CONTROL MANAGEMENT STRATEGY

3.1 Alberta Transportation Requirements

Alberta Transportation intends that the Erosion and Sediment Control Plans be prepared by experienced, competent individuals or firms. It is the intention that the contractor delivers the construction work in conformance with the specifications. Construction monitoring is provided and interim audits are conducted by AT or the consultant of record for the construction project.

Consultants and contractors are required to meet various responsibilities concerning environmental protection. Their responsibilities are discussed in the following sections.

3.1.1 Consultant Responsibility – Permanent Erosion and Sediment Control Plan

The design consultant is required to prepare the Permanent Erosion and Sediment Control Plan (PESC Plan) for the project.

This document is provided to the contractor for use in preparing the temporary erosion and sediment control strategy contained in the ECO Plan.

The requirements for the PESC prepared by the consultant are detailed in Section 9.0.

3.1.2 Contractor Responsibility – ECO Plan

During the execution of the contract, the contractor, as the prime occupant of the site, will be responsible for environmental protection of the site and to minimize potential environmental hazards that can arise as a result of his construction activities. The contractor is required to implement an Environmental Construction Operations (ECO) Plan detailing environmental protection measures under the guidelines of the ECO Plan Framework (AT et al. 2011). The most up-to-date details on the ECO Plan Framework are found on AT's website at <http://www.transportation.alberta.ca/571.htm>.

3.1.3 Consultant's Qualification to Design and Audit

Both the ECO Plan and PESC Plan must be completed by individuals or firms with appropriate experience in both highway design and construction and erosion and sediment control practice. The designer and auditor of the PESC Plan or reviewer of the erosion and sediment control strategy contained within the ECO Plan should also be one of the following:

- Registered Professional Engineer or Geoscientist (APEGGA Professional member); and/or
- Certified Professional in Erosion and Sediment Control (CPESC).

3.2 Overview of Preparation of Erosion and Sediment Control Plans

The process involved in preparing an erosion and sediment control strategy as well as maintaining and revising the measures contained therein is presented in Figure 3.1. In this figure the general steps involved in preparing permanent and temporary erosion and sediment control plans throughout the various phases of a highway construction project are presented as a flow chart.

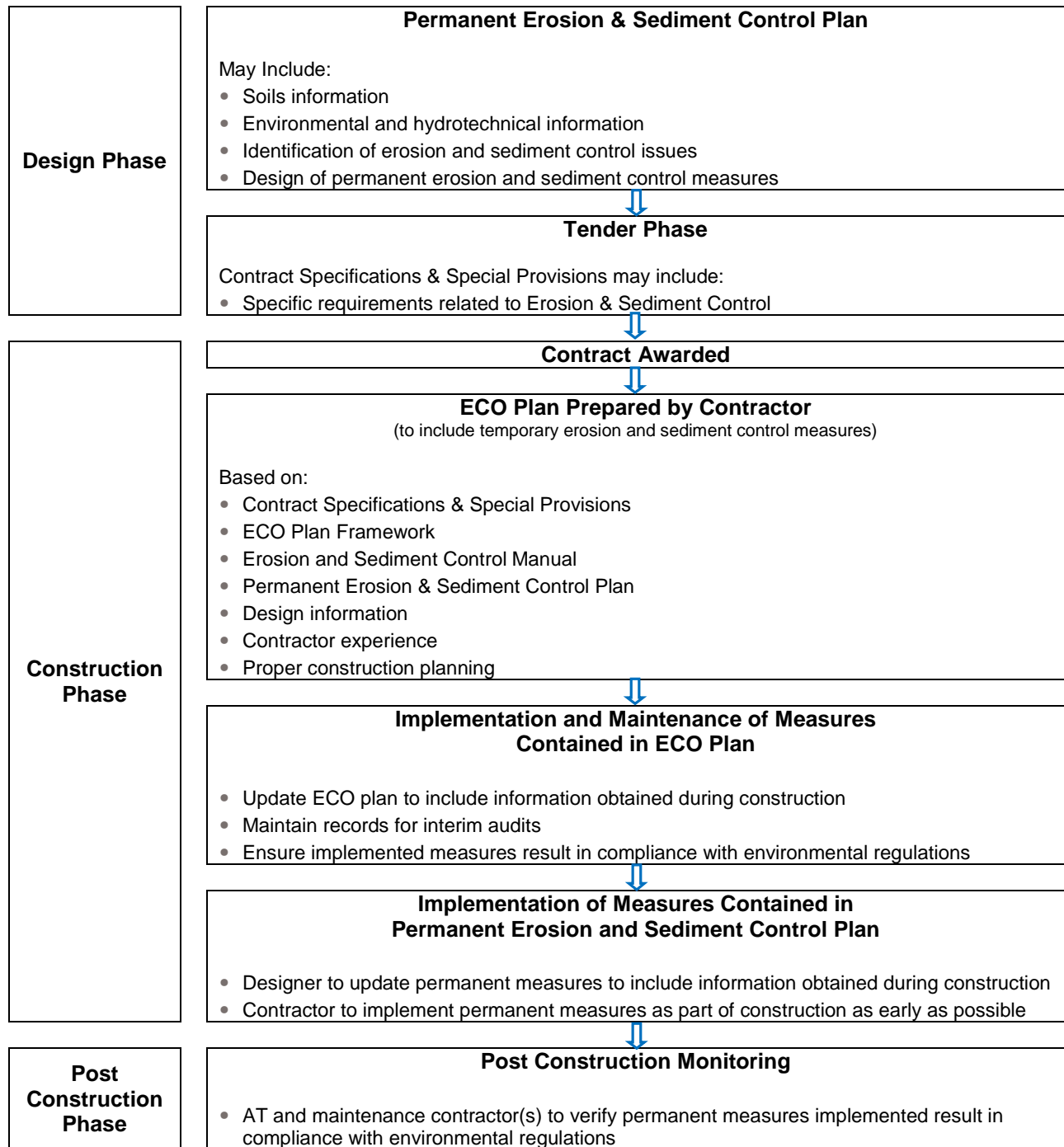

Figure 3.1: AT Management Strategy for Erosion and Sediment Control on Construction Projects

4.0 EROSION AND SEDIMENT PROCESS

4.1 Mechanics of Erosion

Erosion is the wearing away of material by naturally occurring agents through the detachment and transport of soil materials from one location to another, usually at a lower elevation. Natural agents are mostly responsible for this phenomenon but the extent to which erosion occurs can be considerably accelerated through human activities.

Water is the predominant agent of erosion on highway construction sites. Wind erosion is not considered a major contributing factor to erosion on highway construction projects because of the localized nature of the exposed areas and the relatively short construction time periods. Thus, methods of controlling water erosion will be the principal focus of this manual. However, many of the methods effective in reducing erosion caused by water are also effective in reducing erosion caused by wind.

4.2 Sedimentation

Sedimentation is the deposition of soil particles previously held in suspension by flowing water. The phenomenon of sedimentation takes place at those locations experiencing a reduction in the velocity of flow. Initially the larger particles settle out. As the flow velocity reduces further, the smaller particles settle, eventually, leaving only the clay sized particles, being the smallest, as the last to be deposited. Sedimentation can also occur in slower-moving, quiescent waterbodies, or in treatment facilities such as stormwater ponds. For the purpose of this document, the process of sediment control is equivalent to the control of the sedimentation process.

Suspended material, particularly fine organic material such as organic silt, can have low total suspended solids (TSS) test values but high turbidity measurements. TSS is the mass of suspended solids per volume of water whereas turbidity is an indication of the ability of light to pass through the water. Both TSS and turbidity can have detrimental effects on an aquatic environment.

Clay particles will only settle out after extended periods of time due to their fine particle size and, the potentially, elevated pH of the water. As a result, settling by gravity alone is often ineffective for clay size particles.

4.3 Types of Water Erosion

There are generally four types of erosion that result from water which are illustrated in Figure 4.1.

1. **Raindrop (Splash) Erosion:** Movement of soil particles caused by the direct impact of raindrops on unprotected exposed soil surfaces.
2. **Sheet Erosion:** Movement of soil particles by runoff flowing over the ground surface as an unconcentrated thin sheet layer. Erosion is caused by shear stresses associated with water flow.
3. **Rill and Gully Erosion:** Movement of soil particles due to concentration of runoff in the depressions (rills) in the ground surface. Erosion potential is greater than with sheet flow due to the greater velocity and depth of flow. Further increases in the

velocity and depth of flow will increase the erosion potential which may gradually enlarge the rills into gullies. Rills are 75 mm or less in depth. Once the depth exceeds 75 mm then formation of gullies occurs (Fifield, 2001).

4. **Stream and Channel Erosion:** Movement of soil particles on the bed and banks of streams and channels due to concentration of runoff. Scouring, another facet of channel erosion, occurs along channels where eddies form as a result of sudden expansion, contraction or change in flow direction. Scouring may lead to rapid soil loss from the channel bed or sideslopes.

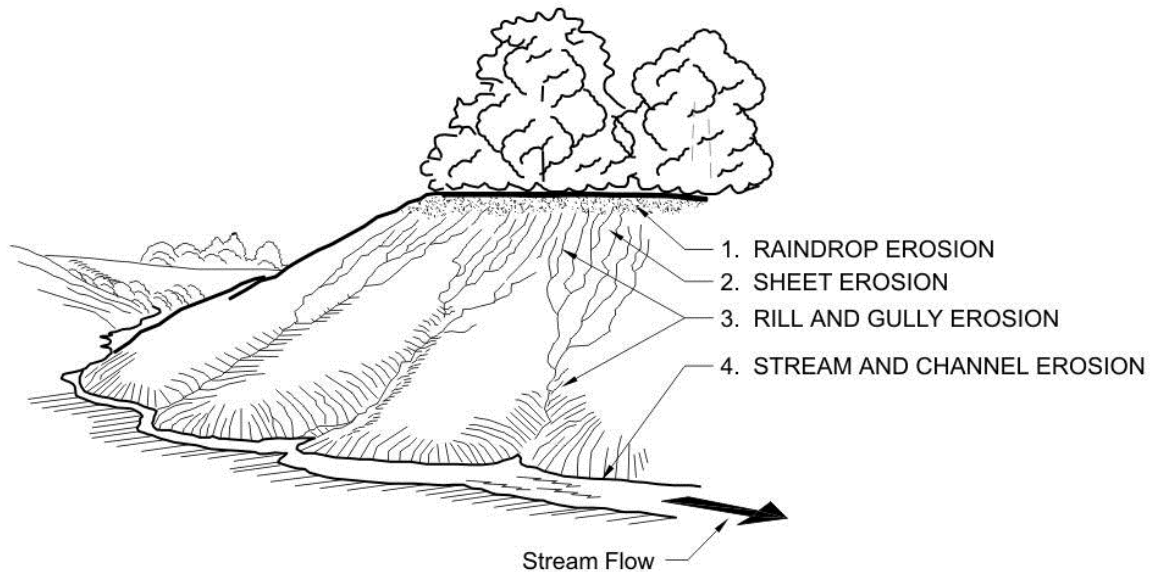

Figure 4.1: Types of Water Erosion

Erosion potential is reduced by minimizing rainfall impact and by reducing the velocity and depth of surface water flow. The erosion potential increases with increasing flow velocity and depth.

4.4 Factors Affecting Erosion

4.4.1 General

Erosion occurs as a result of a number of interacting factors and processes. Four broad factors that affect erosion are as follows:

- Climate;
- Soil characteristics;
- Vegetative cover; and
- Topography.

Each of these factors is described in the following sections.

4.4.2 Climate

The regional climate varies across the province of Alberta. As such, design rainfall event duration and intensity may vary for a given return period based on the location of

the site. Rainfall events of greater duration and intensity are more likely to increase the potential for erosion on any given site.

Indirectly, the climate of a location determines the amount of annual precipitation, the length of the growing season and some other factors that affect plant growth and hence the vegetative cover. The climate may have a long term effect on topography especially in reference to wind eroded gully formation in Southern Alberta. The climate also affects soil characteristics. Arid terrain with intermittent intense rainfall events can be highly erosive environments.

4.4.3 Soil Characteristics

Soil characteristics that have been identified as primarily affecting soil erodibility are listed as follows:

- Particle Size Distribution and Texture;
- Permeability (structure); and
- Fibrous organic matter content (structure).

A preliminary estimate of soil erodibility in relationship to soil type is presented in Figure 4.2.

In general, soils containing high proportions of silt and very fine sand are usually the most erodible. Erodibility generally decreases as the plasticity (clay content) of the soil increases (Figure 4.2). However, once eroded, clays are readily transported. Well-graded gravel and predominantly gravel mixtures with trace amounts of silt are the least erodible soils. Soil descriptions prepared using the guidelines suggested in the Unified Soil Classification System (USCS) can be used in a preliminary assessment of soil erodibility. This classification system is presented in Figure 4.3. The various descriptions given for grain size according to various other engineering soil classification systems are presented in Figure 4.4.

The ability of a soil to absorb rainfall or surface runoff is best characterized by its permeability. The potential for erosion is reduced if the soil tends to absorb rainfall or surface runoff as this decreases the volume of water available to cause sheet or rill and gully erosion. However, after a prolonged period of hot and dry weather, there may be a lag time between the onset of rainfall and the onset of infiltration due to the unsaturated nature of the exposed surface soils. In this event, the initial amount of runoff may be significant. A general relationship between soil type and precipitation runoff is presented in Figure 4.5.

Construction site experience in Alberta indicates that topsoil can be effective in reducing or preventing erosion. This observed behaviour is mainly due to the permeability and fibrous nature of the organic material in the topsoil. An organic rich soil placed in an unsaturated condition generally has the ability to absorb a significant amount of water. Furthermore, the various rootlets and fibres present in topsoil act as reinforcement that minimizes the effect of raindrop, sheet or rill and gully erosion.

Available examples of tested data for typical Alberta soil types are presented in Appendix A to illustrate typical plasticity and gradation characteristics. This information is included for the sole purpose of illustrating the variety of soils that could be

encountered on highway construction sites in Alberta. It is not intended as an exhaustive list of soil types, nor should it be used to replace or supplement soil testing data for sites near or at the locations listed.

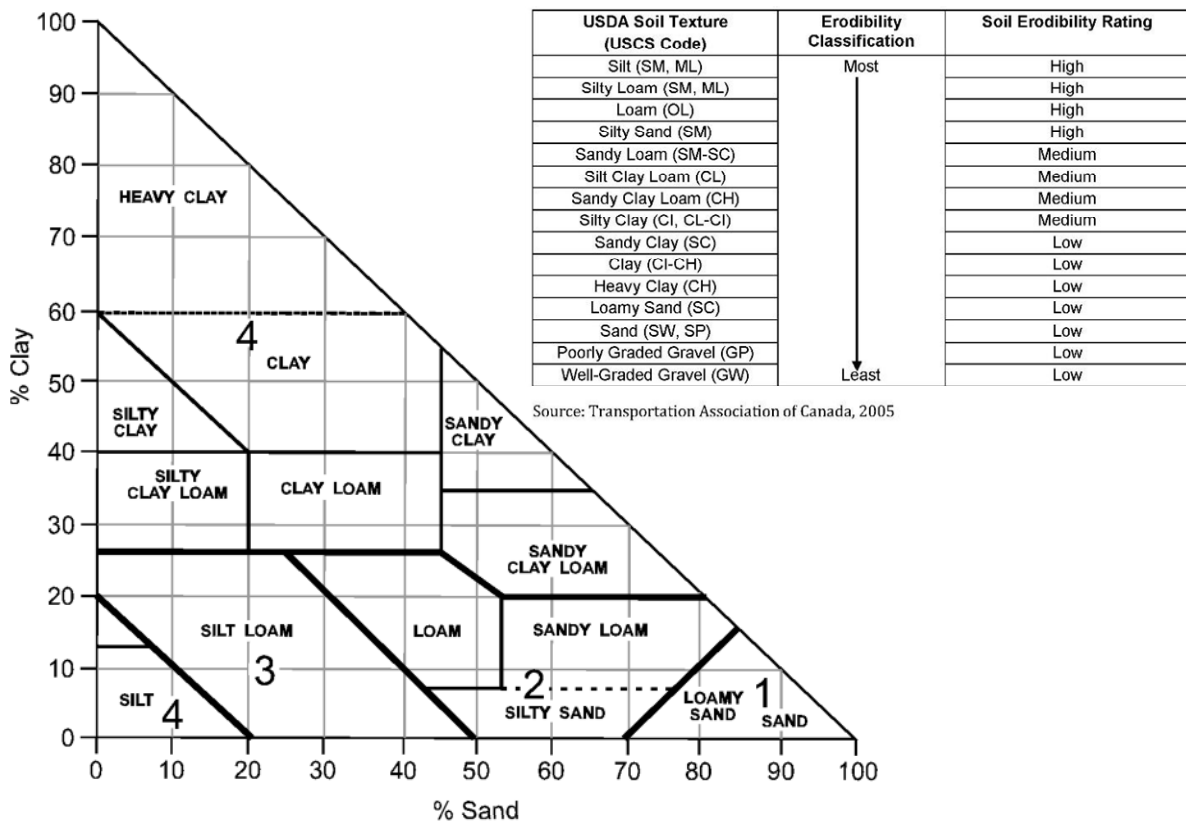

Figure 4.2: Soil Texture Nomograph and Erodibility Rating

Source: Wall et al, 1997

UNIFIED SOIL CLASSIFICATION SYSTEM
(Modified by PFRA)

| MAJOR DIVISIONS | GROUP SYMBOLS | LOG SYMBOLS | TYPICAL NAMES | LABORATORY CLASSIFICATION CRITERIA | |
|---|--|---|--|--|---|
| COARSE GRAINED SOILS (More than half of material is larger than No. 80 sieve size) | GRAVELS (More than half of coarse fraction is larger than No. 5000 sieve size) | GW | Well-graded gravels, gravel-sand mixtures, little or no fines | $C_u = \frac{D_{60}}{D_{10}}$ is greater than 4; $C_c = \frac{(D_{30})^2}{D_{10} \times D_{60}}$ is between 1 and 3 Not meeting all gradation requirements for GW | |
| | | GP | Poorly graded gravels, gravel-sand mixtures, little or no fines | | |
| | CLEAN GRAVELS (Little or no fines) | GRAVELS WITH FINES (Appreciable amount of fines) | GM* | Silty gravels, gravel-sand-silt mixtures | Atterberg Limits below "A" Line or P.I. is less than 4 Atterberg Limits above "A" Line with P.I. greater than 7 Above "A" Line with P.I. between 4 and 7 are borderline cases requiring use of dual symbols |
| | | | GC | | |
| | SANDS (More than half of coarse fraction is smaller than No. 5000 sieve size) | CLEAN SANDS (Little or no fines) | SW | Well-graded sands, gravelly sands, little or no fines | $C_u = \frac{D_{60}}{D_{10}}$ is greater than 6; $C_c = \frac{(D_{30})^2}{D_{10} \times D_{60}}$ is between 1 and 3 Not meeting all gradation requirements for SW |
| | | | SP | Poorly graded sands, gravelly sands, little or no fines | |
| | SANDS WITH FINES (Appreciable amount of fines) | SM* | SM* | Silty sands: sand-silt mixtures | Atterberg Limits below "A" Line or P.I. less than 4 Atterberg Limits above "A" Line with P.I. greater than 7 Limits plotting in hatched zone with P.I. between 4 and 7 are borderline cases requiring use of dual symbols |
| | | | SC | Clayey sands: sand-clay mixtures | |
| | FINE GRAINED SOILS (More than half of material is smaller than No. 80 sieve size) | CLAYS (Above "A" Line on PLASTICITY CHART; negligible organic content) | CL | Inorganic clays of low plasticity, gravelly clays, sandy clays, silty clays, lean clays | PLASTICITY CHART (NOTE: For soils passing No. 400 sieve & sieve size in µm) |
| | | | CI | Inorganic clays of medium plasticity, gravelly clays, sandy clays, silty clays | |
| CH | | | Inorganic clays of high plasticity, fat clays | | |
| SILTS (Below "A" Line; negligible organic content) | | ML | Inorganic silts and very fine sands, rock flour, silty or clayey fine sands or clayey silts with slight plasticity | | |
| | | MH | Inorganic silts, micaceous or diatomaceous fine sandy or silty soils, elastic silts | | |
| ORGANIC SILTS AND CLAYS (Below "A" Line) | | OL | Organic silts and organic silty clays of low plasticity | | |
| | | OH | Organic clays of medium to high plasticity, organic silts | | |
| HIGHLY ORGANIC SOILS | Pt | Peat and other highly organic soils | Strong colour or odour and fibrous textures | | |

REVISED APRIL 5, 2007

OTHER SYMBOLS

| | | | |
|--|------------------------|--|------------|
| | BEDROCK (Unclassified) | | COAL |
| | SANDSTONE | | OVERBURDEN |
| | SHALE | | TOPSOIL |
| | LIMESTONE | | |
| | CONGLOMERATE | | |

NOTE:

* Division of GM and SM groups into subdivisions of d and u are for roads and airfields only. Subdivision is based on Atterberg Limits; suffix d is used when L.L. is 28 or less and the P.I. is 6 or less; the suffix u is used when L.L. is greater than 28.

** Borderline classifications, used for soils processing characteristics of two groups, are designated by combination of group symbols. For example: GW-GC, well-graded gravel-sand mixture with clay binder.

Figure 4.3: Unified Soil Classification System (modified by PFRA)

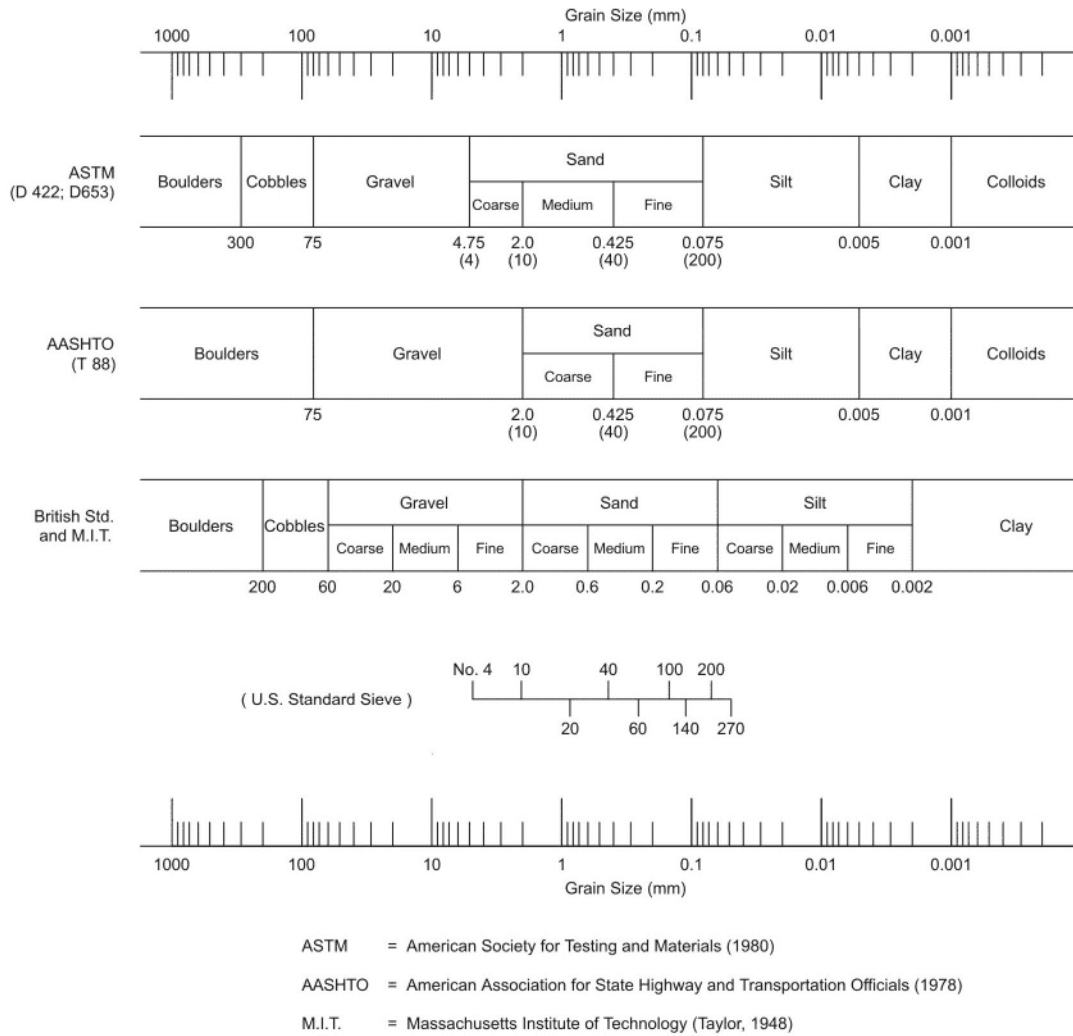

Figure 4.4: Grain Size Description According to Various Engineering Soil Classification Systems

Source: Holtz and Kovacs, 1981

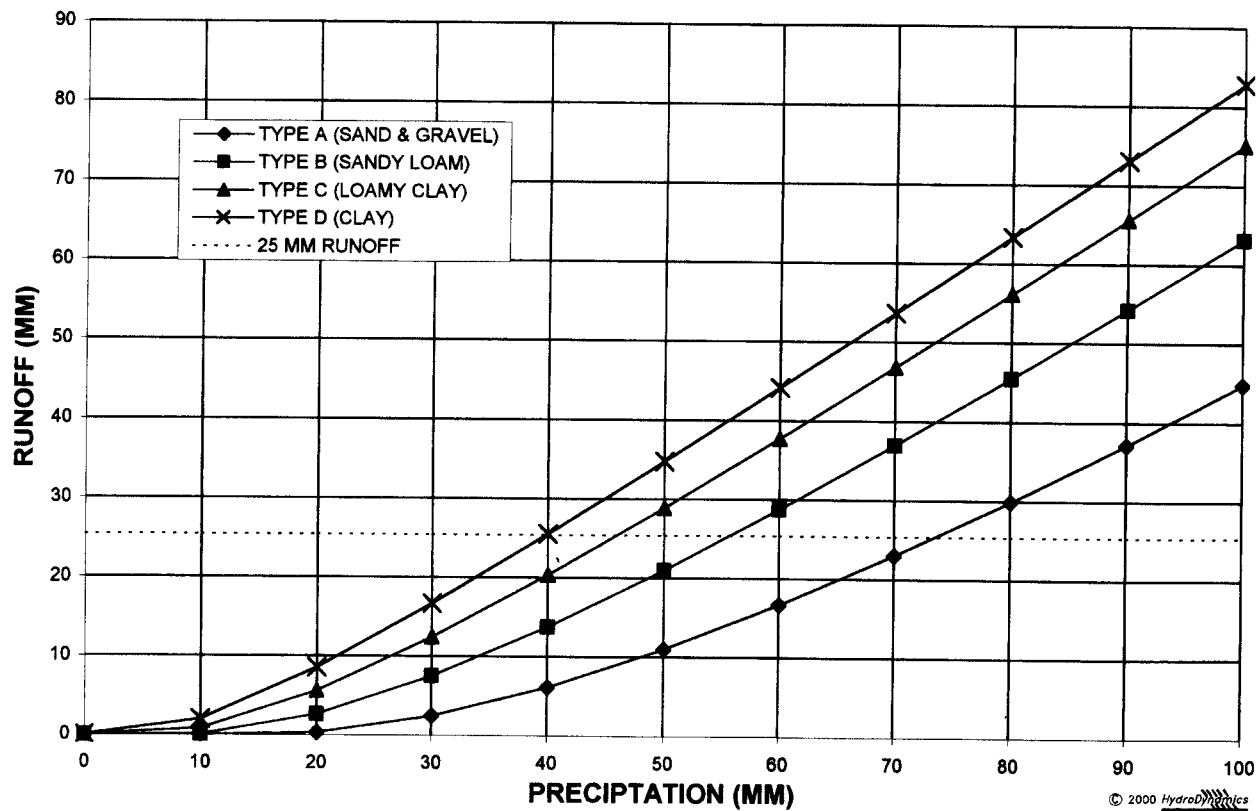

Figure 4.5: Estimated Runoff from Precipitation for Different Soil Types

Source: Fifield, 2001

4.4.4 Soil (Vegetative) Cover

In nature, the extent of vegetative cover determines to a large extent the erosion that takes place. Vegetative cover is a very durable and highly effective erosion control measure. It achieves its objective by:

- Shielding the ground from direct rainfall impact;
- Improving the soil permeability;
- Reducing velocity of runoff; and
- Holding soil particles in place with a root structure from living and dead vegetation (topsoil).

Because of the effectiveness of vegetative cover in controlling soil erosion, it is usually the primary choice for long-term erosion control unless there are reasons for doing otherwise.

4.4.5 Topography

Topography refers to the shape, length, inclination and aspect of a slope. The length and inclination are critical factors with longer and steeper slopes producing greater soil erosion. Slope aspect also affects soil erosion. For example, south-facing slopes tend to dry faster and have a better growing regime than north-facing slopes. The shape of a slope also influences the potential extent of erosion. Concave slopes with less inclination at the base are generally less erodible than convex slopes.

5.0 SITE ASSESSMENT

5.1 General

Background information for the proposed construction site should be assembled to permit a preliminary assessment of the drainage and erosion potential of the site as well as for identification of environmentally sensitive areas. Identifying these areas will assist in evaluating the erosion and sediment control measures to be implemented on and downstream of the proposed construction site.

Various sources of information for use in preparing a site assessment are discussed in the following sections. This section is not intended to be an exhaustive list of information sources. Therefore, it is the responsibility of the individual or firm preparing an erosion control strategy to ensure they have considered the appropriate relevant information.

5.1.1 Review of Construction Drawings

Design drawings will provide some of the information necessary for the preparation of an erosion and sediment control plan. This information includes, but is not limited to, the location, size and gradient of grubbing areas and stripping areas, vertical and horizontal road alignments, cut slopes and embankment slopes, ditchlines, culverts, bridges and watercourse crossings, riparian zones, and special sites such as borrow pits, gravel pits, and spoil areas.

5.1.2 Geotechnical Investigation Reports

Geotechnical information such as borehole logs, test pit logs, and accompanying reports are available for the majority of highway construction projects in Alberta. This information will likely indicate the type of soils encountered in the area, detailed soil descriptions, the thickness of each unit, moisture contents, soil strength values, and water table levels from discrete locations. In some cases, topsoil assessments or slope stability assessments may have been conducted.

Geotechnical investigation for highway design usually includes aerial photo review, terrain assessment and soil survey investigation for both gradeline and borrow sources. An assessment of difficult/adverse site conditions (i.e., unstable slope, soft subgrade, high groundwater, highly erodible soils) may also be provided. Current AT geotechnical investigation requirements are provided in Engineering Consultant Guidelines for Highway and Bridge Projects Volume 1, Design and Tender (AT, 2002). In general, the depths of soil sampling should extend beneath the design grade for cut slopes, ditch bottoms, and to the maximum depths of proposed borrow source areas. Site assessment of riparian and other sensitive areas of water bodies, floodplains and river crossings may be undertaken to evaluate stability of fills as well as to identify possible erosion and sediment control concerns.

For a typical earthwork grading project, the following soil testing information is provided on the design drawings:

- Plasticity index (PI);
- Soil classification according to USCS;

- Moisture content (%);
- Estimated optimum moisture content (%); and
- Estimated maximum dry density from moisture density relationship testing (kg/m³).

Depending on the scope of work, the geotechnical report may include the following additional information related to erosion and sediment control concerns:

- A review of the gradeline design from a geotechnical as well as an erosion perspective;
- Hydrometer (gradation) and Atterberg Limit testing results for fine-grained soils;
- Soil permeability; and
- Stability of large cuts and high fill areas.

Furthermore, additional reports prepared for environmental and hydrotechnical aspects of the project may contain the following information:

- Identification of possible environmentally sensitive areas including riparian zones, wetlands and fish bearing watercourses;
- Identification of obvious watercourses and assessment for fish habitat; and
- Construction timing restrictions related to fish and wildlife considerations.

5.1.3 Aerial Photography/Imagery

A review of available aerial photographs can provide an overview of landforms and surface features in and adjacent to the construction site. Overlaying the proposed highway alignment on the aerial photos will allow an assessment of conditions such as slope instability. A review of aerial photos will be useful in evaluating drainage patterns, such as drainage catchment size, historic drainage features, ephemeral streams, and lowlands.

Web-based aerial image technology can provide additional information such as type and extent of soil cover, and type and extent of vegetation.

Sources of aerial photographs in Alberta include the following:

- Alberta Environment;
- William C. Wonders Map Collection, University of Alberta;
- Municipalities;
- Alberta Sustainable Resource Development; and
- Alberta Transportation.

5.1.4 Surficial Geology Maps

Surficial geology maps are another source of information regarding the soils that may be encountered during construction. These maps may be used to interpolate soil conditions between drill holes or test pits (with inherent uncertainty) and may also assist in the delineation of the boundaries of various soil types.

The type of information found on surficial geology maps may include type and extent of soil, thickness and bedding characteristics of each soil type, soil stratigraphy, depth to bedrock, and in some instances, the erodibility rating.

Sources for surficial geology maps include:

- Alberta Geological Survey;
- Alberta Research Council;
- Alberta Environment; and
- Geological Survey of Canada.

5.1.5 Vegetative Cover Maps

Vegetative cover maps are typically developed through the analysis of moisture and nutrient regimes. They can provide information about the type and extent of vegetation, the drainage class and soil texture.

Information on vegetative cover will help identify the rooting conditions that may be encountered during grubbing and stripping operations. Furthermore, the existing vegetation will provide the best model for success of revegetation efforts by defining the biogeoclimatic zones and indicating the advantages and limitations of the site for revegetation (for example, arid versus wet conditions).

Vegetative cover maps come in various forms. Some are developed to address specific concerns such as new development and others are developed for inventory purposes. For the purpose of erosion and sediment control planning, site level vegetative cover maps (scale 1:10,000 or less) are the most useful and provide the level of detail required for characterizing a construction site and developing specific erosion and sediment control measures. Overview maps of larger scale may not provide enough detail to plan specific measures, but may be useful for characterizing general site conditions.

Sources for vegetative cover maps include:

- Alberta Environment;
- Environment Canada; and
- Agriculture and Agri-Food Canada.

5.1.6 Floodplain Information

Floodplain information is important data to identify siltation processes associated with natural flooding as opposed to sedimentation caused by construction activities.

Sources for floodplain information include:

- Alberta Environment;
- Environment Canada;
- Agriculture and Agri-Food Canada; and
- Local Municipalities.

Floodplain information should be shown on the drawings that accompany the documentation for an erosion and sediment control strategy.

5.1.7 Site Inspection

A site inspection of the proposed construction site is a fundamental step in the preparation of an erosion and sediment control strategy. Observations of the site conditions will provide the greatest level of detail for characterizing potential erosion and sediment control concerns. A site inspection should be conducted at the appropriate time of year with no snow cover and/or after a rainfall event if possible.

Site inspections should be conducted after the aforementioned sources of information are reviewed. A site inspection should involve a reconnaissance of the highway alignment route to assess and document the following information:

- Soil Types: The soil types in an area to be disturbed by construction activities should be described according to the USCS in conjunction with Agriculture Soil Structure Code in the Soil Erodibility Rating table as presented in Figure 4.2. This information may be assessed by inspecting existing soil exposures or by conducting shallow test pits in the area. The focus should be on areas of anticipated high erosion potential.
- Watercourses: Potential areas of concentrated drainage and areas of surface or groundwater concentration should be noted on the site plans. The field inspection should focus on determining the potential for sedimentation and consequences downstream of the construction site. Depending on the nature of the construction an estimate of the bank full elevation may be required.
- Water Crossings: Water crossings, including watercourses and drainage ditches, should be noted.
- Riparian Zones: The location, size, and general descriptions of riparian zones should be noted. Furthermore, the presence of watercourses originating from or passing through the construction site that are buffered by these zones and their respective gradients should be noted.
- Vegetation: Existing and adjacent vegetation should be noted in terms of location, type and extent.
- Slope Failures: Signs of recent or historic slope failures or evidence of instability should be noted. Assessment by a geotechnical engineer may be required to determine the cause of slope failure.
- Erosion Sites: Areas of recent or past erosion and sedimentation events should be noted.
- Sensitive Sites: Potentially sensitive sites such as drinking water supplies, wildlife habitat, private property, utilities, and recreational areas should be noted.

5.1.8 Referrals with Regulatory Agencies

Various regulatory agencies may have specific and/or detailed information about the construction site. Therefore, consultation is an important step in conducting a site assessment. Information from regulatory agencies may include detailed fish and wildlife

habitat information, historical data such as rainfall records or past slope failures, revegetation limitations or requirements, information on previously implemented erosion and sediment control measures and permitting requirements.

Where applicable, site specific information should be obtained from the appropriate regulatory agencies. These agencies may include the following:

- Alberta Environment;
- Alberta Agriculture and Rural Development; and
- Alberta Sustainable Resource Development.

THIS PAGE LEFT BLANK INTENTIONALLY.

6.0 SITE EROSION POTENTIAL AND EVALUATION

6.1 General

The foremost challenge facing the designer is to correctly assess the erosion potential resulting from the construction activities. The site erosion potential is an estimate of the quantity of soil that could be removed from the construction site due to erosion and transportation by unconcentrated surface water flow. With certain modifications, established soil loss evaluation methods used in agricultural practice can be reasonably applied to the highway construction practice. The estimates produced by using these methods should be supplemented with judgement and experience so that the site erosion potential assessment is appropriate for the construction site.

6.2 Revised Universal Soil Loss Equation (RUSLE)

A number of methods to assess site erosion potential have been developed. Two approaches are in current practice for estimating highway construction site erosion potential. One is an empirical method based mainly on experience, the other is the Revised Universal Soil Loss Equation (RUSLE) which is an update of the Universal Soil Loss Equation (USLE). RUSLE's calculations are computerized as are the databases which include information on soil erodibility (K) and climate (R) data for all major soils and cities across the United States. As this program was developed in the United States no data is available for Canadian locations. The Revised Universal Soil Loss Equation for Application in Canada (RUSLE-FAC) (Wall et al, 1997) is a revision of RUSLE, modified for use in Canada and is not available in the form of a computerized software and data package.

The upgraded version of the RUSLE has been developed and is known as RUSLE Version 2, (RUSLE2). It uses the same input parameters as RUSLE to provide erosion and sediment delivery estimates. The new aspects of RUSLE2 are:

- Most factors and relationships have been revised.
- More current climate data.
- Model calculates soil loss for every day of the year. The average annual soil loss is the sum of all daily values.
- Windows based graphical user interface which allows the user flexibility in the types of situations to be represented.

RUSLE2 does not contain data for Canadian locations.

Additional information about RUSLE2 can be found at http://fargo.nserl.purdue.edu/rusle2_dataweb/RUSLE2_Index.htm

USLE/RUSLE only predicts the amount of soil loss that results from sheet or rill erosion on a single slope and does not account for additional soil losses that might occur from gully, wind or tillage erosion nor does it calculate sediment yield.

For the remainder of this manual, references and examples will focus on RUSLE-FAC, which will be simply referred to as "RUSLE".

The RUSLE formula is as follows:

$$A = R \times K \times LS \times C \times P \quad \text{(Equation 6.1)}$$

Where: A = Annual soil loss (tonnes ha⁻¹ year⁻¹)
R = Rainfall factor (MJ mm ha⁻¹ hour⁻¹ year⁻¹)
K = Soil erodibility factor (tonne hour MJ⁻¹ mm⁻¹)
LS = L and S are the slope length and steepness factors, respectively (dimensionless)
C = Vegetation and Management Factor (dimensionless)
P = Support Practice Factor (dimensionless)

Supporting information to assist in the selection of these factors is presented in Appendix B.

6.2.1 Rainfall Factor, R

The rainfall factor, R, is a measure of the total annual erosive rainfall for a specific location, combined with the distribution of erosive rainfall throughout the year. The high energy thunderstorms of the summer months are generally regarded to be the most potentially erosive events in most areas of Alberta.

The rainfall factor is the average annual sum of the products of the two variables most critical to a storm's erosivity:

- Volume of rainfall and runoff (E); and
- Prolonged-peak rates of detachment and runoff (I) (Wischmeier and Smith, 1978).

EI is the total kinetic energy of a storm multiplied by the maximum 30-minute intensity.

R is estimated through the use of the following three primary methods:

1. Measured rainstorm EI values. This method is suitable if 22 or more years of rainfall intensity data is available (Wischmeier and Smith, 1978).
2. Equations which rely on an empirical relationship between R and the one-in-two year, 6 hour storm, (Ateshian, 1974; Madramootoo, 1988; Wall et al., 1983).
3. Hourly precipitation records, where available, to predict R (Wigham and Stolte, 1986).

The aforementioned three methods used to estimate R have been used to produce the following reference materials for Canadian conditions:

- Isoerodent maps which indicate annual R values for an area and can be used to calculate average annual soil losses;
- Monthly distribution of R which indicates the proportion of annual erosive rainfall that falls during each month; and
- Mean annual rainfall on frozen soil maps, which may indicate areas where rain falling on frozen soil could pose an erosion risk.

It is typical in roadway construction to re-establish grass vegetation as soon as practicable after grading has been complete. In many cases, the contractual requirements necessitate that seeding and fertilizing be quickly undertaken by the contractor, preferably as soon as cut and fill slope surfaces are completed. Through this activity, the sediment yield from a site can be reduced from that anticipated for an entire year of exposure. In these cases, it is more appropriate to assign a monthly distribution of the soil loss over a time period where the soils are anticipated to be exposed. Therefore, an R value can be estimated for the entire year (R_t) or for a portion or season of the year (R_s). The estimation of R_t and R_s is discussed in the following paragraphs.

Estimation of R_t

The following procedure may be followed to estimate a value of R_t :

1. Locate the area of interest in Figure B-1, Appendix B, Isoerodent map showing R_t values (yearly) for the Prairie Region. Extrapolate point or area relative to R_t factor contours.
2. Similarly, locate the area of interest in Figure B-3, Appendix B, adjustment for winter conditions, R_s for the Prairie Region.
3. R values for spring to fall are presented in Figure B-2, Appendix B for non-winter conditions.

Estimation of R_s

The following procedure may be followed to estimate a value of R_s :

- Determine time of interest;
- Select the monthly distribution from climatic station closest to the area of interest from Figure B-4 and Table B-1, Appendix B;
- Add the monthly values for the time of interest and determine a percentage of R_t for the construction period; and
- Multiply the value by the total annual R_t value to obtain the seasonal R value.

6.2.2 Soil Erodibility Factor, K

6.2.2.1 Estimation of K

The K factor is a quantitative measure of a soil's inherent susceptibility to erosion. Generally, on the basis of soil characteristics alone, soils with a high percent content of silt and very fine sand particles, as well as a low fibrous organic matter content, will be most erodible. A preliminary assessment of soil erodibility has been presented in Figure 4.2. K values estimated using the methods detailed herein are appropriate for soils encountered in agricultural practice. As such, a soil erodibility adjustment factor (\emptyset_K) is proposed to permit application of the estimated K values to highway construction sites and is discussed in Section 6.2.2.2.

A K value can be calculated for a specific soil, using the following equation (Wischmeier and Smith, 1978).

$$K = [2.1 \times 10^{-4}(12-a)M^{1.14} + 3.25(b-2) + 2.5(c-3)]/100 \quad (\text{Equation 6.2})$$

Where: M = (% silt + very fine sand) x (100 - % clay)
a = % organic matter
b = the soil structure code used in soil classification (Figure B-6), and
c = the profile permeability class (Figure B-7)

The input parameters for the aforementioned equation are routinely characterized through standard soil profile descriptions and laboratory analyses. These parameters are listed as follows:

- % silt plus very fine sand (soil particle sizes between 0.05 and 0.10 mm);
- % sand greater than 0.10 mm;
- Soil structure;
- Permeability; and
- Organic matter content.

Of these variables, organic matter content can usually be assumed to be zero in road embankments or deep cuts.

The soil erodibility nomograph (Figure B-5, Appendix B) provides a graphical solution for determining a soil's K value, and can be used if the percent sand and organic matter fractions in a particular soil are known.

The soil erodibility potential is low for high plasticity clayey soil and coarse to medium grained granular soils; therefore, gradation analysis including hydrometer testing of these soils would not usually be required for an erodibility assessment. The soil erodibility can be high to medium for low to non-plastic soil and soil with significant amounts of silt and fine sand. Therefore gradation analysis including hydrometer testing is required.

Where the soil fractions are not known, K factors have been estimated for a number of surface textures and for approximate organic matter content. Major textural groups and their corresponding K values are listed (Table B-2, Appendix B).

6.2.2.2 Soil Erodibility Adjustment Factor (\emptyset_K)

It should be noted that the soil erodibility factor (K) has been developed for an agricultural setting. It is important to recognize that the level of consolidation and/or compaction of soils encountered on cut and fill areas in a highway construction setting is usually much greater than that encountered in an agricultural setting. Cutslopes in highway construction will consist of consolidated material and fill slopes will have undergone significant compaction effort and moisture conditioning. For fill embankments, compaction energy was exerted on the soils at thin lifts with moisture conditioning (to moisten or dry the soil to an optimum moisture content) to achieve a maximum dry density (Standard Proctor Density). Most highway fills are constructed with mineral soils with minimal organic content. This situation differs greatly from an agriculture setting where soils have been machine agitated to produce loose conditions that promote plant growth. Furthermore, a compact soil in an agricultural setting is not

the same as a well compacted or consolidated soil on a highway construction site. However, despite the compaction efforts to improve soil structure strength in a highway construction setting, silty and low plasticity fine-grained soils are generally considered as highly erodible.

Based on the aforementioned differences in the erodibility for soils encountered in highway construction and agricultural settings, the soil encountered in a highway should have a lower erodibility rating. Thus, a modification factor (\emptyset_K) should be applied to lower the K factor determined as part of the RUSLE approach to estimating soil loss. Based on engineering judgement, a range of 0.5 to 1.0 (with a suggested value of 0.8), is considered appropriate for \emptyset_K . However, the selection of \emptyset_K is to be conducted at the discretion of the individual or firm engaged in estimating soil loss potential should be based on site conditions, experience and judgement. The suggested modification factor of 0.8 has been developed based on judgement for this document and represents a highway construction specific factor to be used in the RUSLE.

6.2.3 Topographic Factor, LS

6.2.3.1 Estimation of LS

The topographic factor, LS, is a combined factor that accounts for the effect of slope length (L) and slope steepness (S) factors on the site erosion potential. It adjusts the erosion prediction for a given slope length and slope angle to account for differences from slope conditions present at the standard erosion monitoring plot on which the USLE was based (LS=1 for slopes 22 m long with 9% grade).

For consolidated soil conditions, such as freshly prepared construction sites, with no to little vegetative cover, values of LS can be evaluated from the Topographic Factor Chart (Table B-3, Appendix B) for slope lengths varying from 2 to 300 m, and slopes ranging from 0.2 to 60%.

The upper end of a slope can be defined as the top of the slope, or the divide down a ridge in the field. The lower end of a slope can be located by moving down the slope, perpendicular to the contours, until a broad area of deposition or a natural or constructed waterway is reached. Reducing either the length or steepness of a slope can reduce soil loss. However, reducing the steepness of a slope results in an increased slope length, thus the overall reduction of soil erosion may not be significant. Another way to reduce soil loss is to place intercepting berms along the contours. While this procedure will effectively reduce the cross-section to a series of simple slopes, costly earthworks may be required to establish the berms, which may not be justified unless fill material is readily acquired at a nearby location.

Estimation of the LS factor for uniform slopes and irregular slopes is discussed in the following paragraphs.

Uniform Slopes

The equation of the LS factor for a uniform slope is given as follows:

$$LS = (sl/22.13)^m \times S \quad (\text{Equation 6.3})$$

The slope factor "S" in RUSLE is given as follows (McCool et al., 1989):

$$S = 10.8\sin(\theta) + 0.03$$

when slope is <9%, length \geq 5 m

$$S = 16.8\sin(\theta) + 0.50$$

when slope \geq 9%, length \geq 5 m

$$S = 3.0\sin(\theta)^{0.8} + 0.56$$

when length <5 m

Where: sl is the slope length of the site (m)

θ is the angle of the slope (in degrees)

m is a coefficient related to the ratio of rill to inter-rill erosion presented in Table B-4.

Irregular Slopes

The RUSLE provides a procedure for separating an irregular slope into segments. This procedure recognizes and adjusts for differences in the type of slope. For example:

- A **convex slope** will have a greater effective LS factor (i.e., a higher erosion estimate) than a uniform slope with the same average gradient; conversely
- A **concave slope** will generally have a lower effective erosion rate than a uniform slope of the same average gradient.

The irregular slope should be divided into a two to five segments that describe varying conditions down slope (i.e., soil type, practices, etc.).

Design examples illustrating evaluation of LS for irregular slope are presented in Appendix H as Examples H.4 and H.5.

6.2.3.2 Topographic Adjustment Factor (\emptyset_{LS})

The RUSLE Topographic factor (LS) was developed for typical agricultural slopes with loosened surficial soils for most soil types of moderate to low erodibility. For highway construction applications, slopes are generally much steeper than this and the surficial soils are much denser. Typical slopes for a highway construction site in Alberta range from 3H:1V (33%) to 6H:1V (16%). Using RUSLE for a typical highway construction slope results in a relatively high LS value and subsequently high site erosion potential based on an agricultural setting. Although it is apparent that steeper slopes are more prone to erosion as a result of increased runoff velocities, the RUSLE classifications for site erosion potential are calibrated or standardized to a much lower slope gradient and therefore will require modification for use on highway construction sites.

In the agriculture practice of assessing the erodibility for slope with loose surficial soils, a gentle slope (9% slope, 22 m length) (Wischmeier and Smith, 1978) was chosen to calibrate a baseline value for slope erodibility factor (LS=1 in RUSLE) with other slope configurations of steepness and length. As a result, the LS factor is dependent on soil conditions, even though it is intended as a modifier for varying slope steepness. In

highway slopes with compacted soils, the same baseline slope configuration will yield a lower slope erodibility (LS) value due to the higher density in highway soils.

Based on the aforementioned differences between a highway construction and agricultural setting, the soils encountered in a highway setting should have a lower slope factor rating. Thus a Topographic Adjustment Factor (\emptyset_{LS}) is applied to lower the LS factor determined as part of the RUSLE approach to estimating soil loss. An \emptyset_{LS} of 0.8 is suggested to address the inherent differences between highway construction and agricultural settings. However, the selection of \emptyset_{LS} is to be conducted at the discretion of the individual or firm estimating soil loss potential based on site conditions, experience and judgement. The adjustment factor has been developed based on judgement for this document and represents a highway construction specific factor to be used in the RUSLE.

6.2.4 Vegetation and Management Factor, C

The C-factor is used to determine the relative effectiveness of soil management systems in terms of vegetation, crop cover and/or artificial protection cover (such as mulch, synthetic erosion protection matting) to effect preventing or reducing soil loss. For bare soil, C=1 can be used; for soil surface protected by mulch C=0.1 to 0.2 is common. Some construction site C-factor values are shown in Tables B-6a and B-6b (Appendix B).

6.2.5 Support Practice Factor, P (Practice Factor)

The P-factor is a measure of the effects of practices designed to modify the contouring flow pattern, grade, or direction of surface runoff and thus reduce the amount of erosion. Generally, a support practice is most effective when it causes eroded sediments to be deposited far upslope, very close to their source. In the absence of any support practices, P should be assumed to be 1.0 in the RUSLE formula. With the use of appropriate construction practice, the P factor can be reduced. For example, the practice of track roughening of bare slope (up/down slope) can reduce the P factor from 1.0 to 0.9. Estimation of P may well be the least accurate and most subject to error of the RUSLE factors, because of less data compared to other factors in the RUSLE formulation.

Some construction site P-factor values are provided in Table B-7, Appendix B.

The RUSLE brings in a mixture of empirical and process-based erosion technology to provide a better measure of the effect of land management on erosion rates. Values are based on hydrologic groups, slope, row grade, ridge height, and the 10-year single storm index values.

6.3 Empirical Method for Sediment Storage/Impoundment

The empirical method presents a general relationship between required storage capacity for sediment laden runoff from the construction site and the area of disturbed or exposed soil. This method should only be used for small drainage areas. Disturbed areas greater than 10 ha or long steep slopes must utilize better estimating procedures such as the RUSLE. It is important to note that consideration of various site specific factors that affect soil erosion rate are taken into account. Therefore, the empirical

method should be used with caution. The main advantage of the empirical approach is in its simplicity and ease of application.

Various jurisdictions utilize storage volume requirements ranging from 40 to 250 m³/ha. Sediment storage/impoundment ponds are normally designed at 1 m depth with a design volume varying from 150 m³/ha (minimum) to 250 m³/ha (recommended). It is assumed that vegetation will be established within one to two years of land disturbances taking place or that there will be at least one clean out of the sedimentation facilities per year. If neither is performed, a storage volume of 250 m³/ha (whenever possible) is recommended for sensitive areas and a minimum storage of 150 m³/ha will be required under conditions of restricted space availability. For design considerations, climate variability of different parts of the Province may affect or may require larger storage/impoundment capacity than mentioned above.

6.4 Examples for Estimating Site Erosion Potential

Examples using the RUSLE for determining the soil erosion potential are presented in Appendix H as Examples H.1, H.2 and H.3.

6.5 Site Evaluation

Once a site assessment has been completed, the information should be summarized to provide a complete summary evaluation of the slope and drainage conditions. The site evaluation is a critical step in the preparation of an erosion and sediment control plan and the summary information should be clearly indicated on drawings and supporting documents.

6.5.1 Slope Analysis Summary

As a minimum, a summary of the conditions of the slope to be exposed should be conducted to estimate the potential sediment loss from a site. Areas of exposure generally include all cut and fill slopes as well as large stockpiles and non-dugout borrow sources. It may be necessary to divide a slope area by drainage breaks and/or soil type. A representative value for each of the following parameters should be indicated on the erosion and sediment control plan drawings and supporting documents:

- **Soil Type:** Each distinctly separate soil type to be encountered should be delineated by area on the site plan. Where distinct soil type boundaries are not known or cannot be inferred, estimations of soil type areas are acceptable. Information from the site assessment will be helpful in defining the various soil types by area. Additional information gathered during construction can be used to update the soil type areas.
- **RUSLE Factors:** The RUSLE factors (R, K, LS, C, and P) as defined in Section 6.2 should be summarized for the general conditions of the site and for the specific conditions for each distinctly separate soil/ slope area to be encountered on the site.
- **Site Erosion Potential / Hazard Class:** Using the RUSLE factors, the soil erosion potential (tonnes/ha/year) should be estimated for each distinct area and period of anticipated construction activity. For the soil loss estimated for a particular site, the associated hazard classification can be obtained from Table 6.1.

- **Special Sites:** Any sites of special consideration should be indicated on the site plan, such as locations of potential slope instability, seepage, or borrow sources.

6.5.2 Drainage Analysis Summary

As a minimum, a summary of the drainage conditions to be encountered should be conducted and provided as information on the erosion and sediment control plan drawings and support documents.

- **Drainage Catchment Areas:** A topographic site plan of the construction site and contributing drainage catchment area(s) needs to be divided into smaller drainage areas based on topographic breaks in slope. Then, for each of the drainage areas identified, an estimate of size in hectares (ha) should be provided. Where the site has to be re-graded to final elevations, the direction of sediment-laden flow could change. Overland flow routes, for both initial and final site grade conditions, should be checked to ensure that the appropriate downstream environmental sensitivity has been evaluated.
- **Watercourses:** If not already shown on the topographic site plan, all watercourses should be identified and labelled. Watercourses consist of all areas of channelized flow (streams, creeks, ditches), as well as drainage collection features such as swamps, ponds and lakes. Design drawings should show all proposed ditchlines, catchments and crossings in addition to the natural drainage features. Information on watercourses should extend beyond the limits of the construction site. As a minimum, drainage connectivity should be established to the nearest body of sensitive water downstream of the construction site.
- **Fisheries Classifications:** Watercourses should be labelled with the appropriate fisheries classification.
- **Floodplain Information:** Where applicable, a clear definition of the floodplain limits should be shown on the drawings.
- **Special Sites:** Sites of special consideration should be indicated on the drawings.

6.5.3 Site Hazard Classification

Site hazard classification can be obtained from Table 6.1 below based on the estimate of site erosion potential (tonnes / ha / year).

Table 6.1: Site Hazard Classification (RUSLE-FAC *)

| Site Erosion Potential (tonnes / ha / year) | Hazard Class |
|--|--------------|
| < 6 | Very Low |
| 6-11 | Low |
| 11-22 | Moderate |
| 22-33 | High |
| > 33 | Very High |

Source: Wall et al, 1997*

6.5.4 Connectivity to Downstream Aquatic Resources

The location of the construction site with respect to downstream aquatic resources is a very important factor in preparing an erosion and sediment control plan. Establishing the connectivity of the construction site to downstream water supplies, flood control, fish habitat, navigation, and recreational activities can be conducted using information from the drainage analysis summary.

As far as this manual is concerned, the most negative, and therefore monitored, consequence from erosion and sedimentation is the degradation of water quality and more particularly the impact on fish habitat. The connectivity rating for each distinct segment on a construction site should be shown on the erosion and sediment control plan drawings.

The following table provides ratings based on connectivity to aquatic resources:

Table 6.2: Connectivity Rating to Aquatic Resources

| Connectivity Rating | Criteria ¹ |
|---------------------|---|
| Direct | Any sediment from a construction site is transported directly downstream at a significant gradient (i.e., greater than 5%) to locations where it may result in adverse effects to water quality or aquatic resources. |
| Indirect | Sediment laden water from a construction site empties into a secondary watercourse (i.e., stream, ditch, swale) before connecting with any stream with water quality or aquatic resource values. The secondary watercourse must be a non-fish habitat watercourse, with a channel gradient no more than 5% for a minimum length of 100 m. |
| No Connectivity | For no connectivity, the sediment laden runoff flows into a non-significant swamp or pond and sediment is trapped where water quality or aquatic resources are not a concern, or must terminate before connecting with any stream that has water quality or aquatic resource values. |

¹ Criteria adapted from British Columbia Ministry of Forests (2001).

* Assessment of the significance of a swamp/pond should be undertaken by an environmental engineer/specialist.

7.0 EROSION AND SEDIMENT CONTROL METHODS

7.1 General

It is important to recognize the difference between erosion control measures and sediment control measures when preparing an effective erosion and sediment control plan. The difference between erosion and sediment control methods is defined and summarized for the purposes of this document and all related activities on construction sites as follows:

- Erosion Control is the process whereby the potential for erosion is minimized; and
- Sediment control is the process whereby the potential for eroded soil being transported and/or deposited beyond the limits of the construction site is minimized. In this document, the term "sediment control" is synonymous to sedimentation control.

Erosion control should be viewed as the primary means in preventing the degradation of downstream aquatic resources whereas sediment control should be viewed as a contingency plan. Most erosion control measures are initiated to facilitate the earliest shift to vegetation as the erosion control medium. A greater emphasis must be placed on erosion control, particularly in areas of elevated erosion potential where fine particles that will not readily settle out in a practical time frame are exposed during construction. However, measures to address both erosion control and sediment control are required for most sites.

The design of erosion and sediment control measures should be viewed as a flexible process that responds to new information that is obtained throughout the construction phase. As such, the design of temporary and permanent erosion and sediment control measures should be expected to evolve throughout construction to varying degrees based on site conditions and field performance of implemented measures.

Erosion and sediment control measures are classified into the following categories:

- Temporary measures;
- Permanent measures;
- Minimum requirements (Planning Strategy); and
- Best management practices (BMP).

Each of these categories and BMPs are described in the following sections.

7.1.1 Temporary and Permanent Control Measures

Erosion and sediment control measures can be classified into two broad categories:

- Temporary Measures: Those measures during the construction phase that will be completely removed once permanent measures are installed and/or vegetative cover is established; and
- Permanent Measures: Measures incorporated into the overall design to address long-term, post construction erosion and sediment control.

Temporary erosion and sediment control measures should be installed at the start of the construction phase. Additional measures will likely need to be installed throughout the construction phase. Permanent erosion and sediment control measures can be installed during or at the end of the construction phase.

A listing of erosion and sediment control BMPs are presented in Tables C-1, C-2 and C-3 in Appendix C. Examples of temporary measures include topsoiling, seeding, slope texturing, synthetic permeable barrier, mulching, RECP coverings, silt fence, rolls, wattles, straw bale barriers, etc. Examples of permanent measures include offtake ditch, energy dissipator, berm interceptor, gabion, rock check, sediment pond/basin, etc. Dependent on site conditions, some temporary measures will be retained for a longer duration to render its life span more permanent. Streambank application BMPs are added (Table C-4) in Appendix C.

7.2 Procedural BMPs and Planning Strategy

Procedural BMPs (Table C-5) in Appendix C are often called minimum requirements which are non-structural methods or procedures that can reduce erosion and sediment transport. Proper planning generally constitutes the minimum requirement for preparing an erosion and sediment control strategy. Proper construction planning includes implementing erosion or sedimentation control BMPs early in construction and recognize the impact of different seasons on highway construction sites (e.g., rainfall, snow melt). Various methods of scheduling construction activities can provide the first, best opportunities to help minimize the potential for erosion and sedimentation. However, the minimum requirements are generally not sufficient on their own. As such, many construction projects will require site specific erosion and sediment control measures to be implemented as site conditions dictate. The effectiveness of the erosion and sediment control measures on a site is highly dependent on proper implementation of a well prepared erosion and sediment control plan.

The minimum requirements for planning strategies and procedural BMPs for an erosion and sediment control strategy are presented in Table 7.1.

7.2.1 Understanding the Practice of Erosion and Sediment Control (ESC) as a Whole System

It is important that the designer and contractor recognize that successfully implementing ESC measures requires a good understanding of the principles of the ESC process by both design and field staff. Installing BMPs correctly to specific site conditions and ongoing timely upgrading and maintenance are essential for a successful outcome. The planning strategies and BMPs presented in this document are as equally important as the understanding of the principles of their implementation to achieve good construction performance and protection of the environment.

It is essential to understand that the objectives of the ESC measures begin with education and interaction throughout the planning, design, construction and post construction stages.

Table 7.1: Planning Strategies and Procedural BMPs for ESC Plans

| BMP | Applications | | | | Comments | |
|--|--------------|----------------------|--------------------------|---------------------------|---|---|
| | Slopes | Ditches and Channels | Large Flat Surface Areas | Borrow and Stockpile Area | Advantages | Limitations |
| Minimize Exposed Soils | ✓ | ✓ | ✓ | ✓ | Decreases erosion potential and decreases quantity of erosion and sediment control measures required thus decreasing costs | May require topsoiling/seeding be completed on areas before stripping of new areas |
| Observe Environmental Timing Restrictions | ✓ | ✓ | ✓ | ✓ | Minimizes possible negative impacts on fish and wildlife | May affect project schedule |
| Maximize Work During Favourable Weather | ✓ | ✓ | ✓ | ✓ | Minimizes volume of work required in less desirable (wet) conditions, thus decreasing potential for erosion and sediment transport | May require additional resources to increase scale of production/construction |
| Install BMPs Early | ✓ | ✓ | ✓ | ✓ | Minimizes sediment losses during construction | May cause difficulties with site access or traffic |
| Avoid Wet Weather Periods | ✓ | ✓ | ✓ | ✓ | Minimizes erosion potential | Shutdowns may prolong/delay construction activities |
| Topsoil and Seed Early | ✓ | ✓ | ✓ | | Covers exposed soil and reduces erosion potential | |
| Surface Roughening (Slope Texturing) | ✓ | | ✓ | ✓ | Reduces erosion: estimated 12% for a dozer ripping on the contour, 52% for track walking up and down the slope, 54% for sheep's foot rolling, and 76% for imprinting (Mike Harding, 2010) | Equipment may need to be retasked at a slight increase in construction cost |
| Preserve and Use Existing Drainage Systems | ✓ | ✓ | ✓ | ✓ | Minimizes exposed soils in drainage system | May affect scheduling of certain construction activities |
| Control Construction Traffic | | | | ✓ | Avoids over-trafficking sensitive areas or areas with increased disturbance | Forcing traffic into localized areas may increase disturbance in high-traffic areas |
| Signage | ✓ | ✓ | ✓ | ✓ | Clearly labelling sensitive zones or areas not to be disturbed makes workers aware of work restrictions | Increased costs of signs |

Table 7.1: Planning Strategies and Procedural BMPs for ESC Plans

| BMP | Applications | | | | Comments | |
|---------------------------------------|--------------|----------------------|--------------------------|---------------------------|--|--|
| | Slopes | Ditches and Channels | Large Flat Surface Areas | Borrow and Stockpile Area | Advantages | Limitations |
| Scheduling of Work | ✓ | ✓ | ✓ | ✓ | Placement of topsoil and seeding should be scheduled throughout construction phase. New sections should not be stripped far in advance of construction | May require construction to be completed in one area before starting in another. |
| Stockpile Control | | | | ✓ | Stockpiles should be located well away from watercourses and environmentally sensitive areas | May result in longer haul distances. |
| Direct Surface Water Flow Around Site | ✓ | ✓ | ✓ | ✓ | Keeps surface water from off-site from increasing erosion | Diversion ditches may require erosion and sediment control measures to be implemented. |

7.3 Water Management BMPs

Water management BMPs are measures which can be implemented on-site or off-site. These are intended to control water and reduce erosion potential by following these general principles:

- Keep clean water clean, by diverting clean water around the site and by conveying clean water from undisturbed areas within the site to natural receiving streams;
- Minimize watercourse disturbance by using existing drainage where possible and by integrating on-site drainage into the project design;
- Design new drainage channels to accommodate design discharges and use natural channel design for watercourse diversions; and
- Anticipate and manage groundwater where applicable.

Commonly used water management BMPs are listed in Table 7.2, where the applicability of each BMP to each roadway construction site is noted.

Table 7.2: Surface Water Management BMPs for ESC Plans

| Name | Slopes | Natural Channels | Drainage Channels | Pipes and Culverts | Large Flat Surface | Borrow / Stockpile | Comments | Temporary | Permanent |
|--|--------|------------------|-------------------|--------------------|--------------------|--------------------|--|-----------|-----------|
| Divert Clean Water Around the Site | ✓ | ✓ | ✓ | ✓ | ✓ | ✓ | Clean water drainage from upstream areas should be diverted around the construction site wherever practical, to reduce the quantity of water that must be managed on site. This can be done using ditches, berms, pipes or culverts | ✓ | |
| Keep Clean Water on the Site Clean | ✓ | ✓ | ✓ | ✓ | ✓ | ✓ | Clean water drainage from undisturbed areas within the construction site should be collected and allowed to discharge to receiving streams without being mixed with runoff from disturbed areas | ✓ | |
| Use Existing Drainage | | ✓ | ✓ | ✓ | | | Existing watercourses tend to be well-vegetated and have natural rates of erosion. Discharges from the construction site containing natural levels of sediment should be conveyed to existing, undisturbed watercourses. Care should be taken to ensure that peak flows in the existing watercourse should not be increased significantly | ✓ | |
| Integrate New Drainage into the Project Design | | ✓ | ✓ | ✓ | | | If it is necessary to construct new ditches, pipes or culverts for on-site surface water management, integrating these with the project design will prevent future disturbance due to removal of temporary measures | ✓ | ✓ |
| Keep Drainage Areas Small | ✓ | ✓ | ✓ | ✓ | ✓ | ✓ | Smaller drainage areas generally require less complex erosion control measures and smaller drainage channels, so they are preferred if local topography permits. By discharging from a number of small discharge points rather than a few large ones, the size of sediment control measures is reduced and the magnitude of effects from a potential failure is reduced | ✓ | ✓ |
| Design Drainage Channels Appropriately | | ✓ | ✓ | | | | Drainage channels should be designed with appropriate depths, slopes, cross-sections and linings (armoured or vegetated). Natural channel design is recommended for watercourse diversions. | ✓ | ✓ |
| Manage Shallow Groundwater | ✓ | | | | | ✓ | Slopes, excavations and areas around retaining walls may be sensitive to piping failure or erosion due to high porewater pressures. These can be managed by temporary dewatering or by incorporating permanent drains to reduce porewater pressures. Gravel blankets can also be installed to protect the ground surface. Dewatering wells, if properly screened, may produce clean water and be suitable for direct discharge to receiving streams. | ✓ | ✓ |

Source: Transportation Association of Canada, 2005

7.4 Erosion Control BMPs

BMPs for erosion control are measures that have been proven to work on construction sites when they were properly planned and constructed. These measures reduce erosion potential by stabilizing exposed soil or reducing surface runoff flow velocity. There are generally two types of erosion control BMPs that can be used in conjunction with the minimum requirements:

- Source Control BMPs for protecting exposed surfaces; and
- Runoff Control BMPs.

Overall experience is an integral component in the successful selection of the appropriate BMP(s) and the design and implementation of an overall erosion and sediment control plan. It is the designer's responsibility to select BMPs which are appropriate for site conditions.

Erosion control BMPs may involve the use of bio-engineering methods. Bio-engineering methods are permanent erosion control measures that involve using the roots, stems and leaves of vegetation to reduce the potential for erosion. This is achieved by introducing foliage that decreases impact erosion of rain drops, and increases infiltration of rain into the soil resulting in anchoring of the soil with root systems. As the plants grow, the strength of the bio-engineered erosion control system strengthens. Typically bio-engineering is used to prevent erosion where there are environmental or aesthetic enhancement requirements; however, if properly selected and implemented, it will provide a simple and cost effective measure for controlling long-term erosion problems. Revegetation of exposed soil with locally compatible grass growth on topsoil is the main bio-engineering erosion control method utilized in highway construction in Alberta.

Source Control

The protection of exposed surfaces from the erosive energy of rain splash and surface runoff flow should be the primary goal when selecting appropriate control measures. Cover is the single most effective erosion control BMP for preventing erosion. Cover can include topsoiling in conjunction with one or more of the following: seeding, mulching, hydroseeding, sodding, erosion control blankets, turf reinforcement matting (TRM), riprap, gabion mat, aggregate cover and paving.

An overview of appropriate BMPs for the protection of exposed surfaces with their respective advantages and limitations is presented in Table 7.3.

Runoff Control

During construction it is not always possible or practical to provide surface cover for all disturbed areas. Commonly used methods for runoff control include the modification of slope surfaces, the reduction of slope gradients, controlling flow velocity, diverting flows around the affected area, and providing upstream storage for runoff.

An overview of appropriate BMPs for the runoff control is presented in Table 7.4 with their respective advantages and limitations.

Table 7.3: Erosion Control Measures – Source Control

| BMP # | BMP Name | Applications | | | | Comments | |
|-------|------------|--------------|----------------------|--------------------------|---------------------------|--|---|
| | | Slopes | Ditches and Channels | Large Flat Surface Areas | Borrow and Stockpile Area | Advantages | Limitations |
| 25 | Topsoiling | ✓ | ✓ | ✓ | ✓ | Placing topsoil provides excellent medium for vegetation root structure development, organic content promotes plant growth, reuse organics (topsoil or peat) stripped from the site at start of grading; absorbs raindrop energy to minimize erosion potential | Cannot be effective without seeding and allowing time for plant growth; not appropriate for slopes steeper than 2H:1V (steep slopes will require soil covering over topsoil and specialized design); dry topsoil susceptible to wind erosion, susceptible to erosion prior to establishment of vegetation |
| 22 | Seeding | ✓ | ✓ | ✓ | ✓ | Inexpensive and relatively effective erosion control measure, effectiveness increases with time as vegetation develops, aesthetically pleasing, enhances terrestrial and aquatic habitat | Must be applied over prepared surface (topsoiled), grasses may require periodic maintenance (mowing), uncut dry grass may be a fire hazard, seeding for steep slopes may be difficult, seasonal limitations on seeding effectiveness may not coincide with construction schedule, freshly seeded areas are susceptible to runoff erosion until vegetation is established, reseeding may be required for areas of low growth |
| 23 | Mulching | ✓ | ✓ | ✓ | ✓ | Used alone to protect exposed areas for short periods, protects soil from rainsplash erosion, preserves soil moisture and protects germinating seed from temperature extremes, relatively inexpensive measure of promoting plant growth and slope protection | Application of mulch on steep slopes may be difficult, may require additional specialized equipment. May deplete available nitrogen. Nitrogen rich fertilizer may need to be added |

Table 7.3: Erosion Control Measures – Source Control

| BMP # | BMP Name | Applications | | | | Comments | |
|------------|--|--------------|----------------------|--------------------------|---------------------------|--|---|
| | | Slopes | Ditches and Channels | Large Flat Surface Areas | Borrow and Stockpile Area | Advantages | Limitations |
| 24a 24b | Hydroseeding / Hydromulching | ✓ | ✓ | ✓ | ✓ | Economical and effective on large areas, mulch tackifier may be used to provide immediate protection until seed germination and vegetation is established, allows revegetation of steep slopes where conventional seeding/mulching techniques are very difficult, relatively efficient operation, also provides wind erosion control | Site must be accessible to hydroseeding / hydromulching equipment (usually mounted on trucks with a maximum hose range of approximately 150 m), may require subsequent application in areas of low growth as part of maintenance program |
| 26 | Sodding | ✓ | ✓ | ✓ | ✓ | Provides immediate vegetation and protection, instant buffer strip and/or soft channel lining, can be used on steep slopes, relatively easy to install, may be repaired if damaged, aesthetically pleasing | Expensive, labour intensive to install, sod may not be readily available in all areas of the province, relatively short 'shelf-life' (sod can't be stored on-site for excessive periods of time) |
| 14 | Riprap Armouring | ✓ | ✓ | | | Most applicable as channel lining with geotextile underlay, used for soils where vegetation not easily established, effective for high velocities or concentrations, permits infiltration, dissipates energy of flow from culvert inlets/outlets, easy to install and repair, very durable and virtually maintenance free | Expensive, may require heavy equipment to transport and place rock, may not be feasible in areas of the province where rock is not readily available, may be labour intensive to install; generally thickness of riprap is higher when compared to gabion mattress |
| 13 | Rolled Erosion Control Products (RECP) | ✓ | ✓ | | | Provides a protective covering to bare soil or topsoiled surface where need of erosion protection is high, can be more uniform and longer lasting than mulch, wide range of commercially available products | RECP use is labour intensive to install, temporary blankets may require removal prior to restarting construction activities, RECP not suitable for rocky slopes, proper site preparation is required to seat RECP onto soil correctly; high performance is tied to successful vegetation growth |

Table 7.3: Erosion Control Measures – Source Control

| BMP # | BMP Name | Applications | | | | Comments | |
|-------|-----------------------------|--------------|----------------------|--------------------------|---------------------------|---|--|
| | | Slopes | Ditches and Channels | Large Flat Surface Areas | Borrow and Stockpile Area | Advantages | Limitations |
| 15 | Cellular Confinement System | ✓ | ✓ | | | Lightweight cellular system and easily installed, uses locally available soils for fill to reduce costs | Not commonly used in Alberta highway construction, expensive, installation is labour intensive (hand installation), not suitable for slopes steeper than 1H:1V |
| 27a | Live Staking | ✓ | | ✓ | | Establishes vegetative cover and root mat, reduces flow velocities on vegetative surface, traps sediment laden runoff, aesthetically pleasing once established, grows stronger with time as root structure develops, usually has deeper root structure than grass | Expensive, may be labour intensive to install, not commonly used in Alberta highway construction projects, revegetated areas are subject to erosion until plants are established, plants may be damaged by wildlife, watering is usually required until plants are established |
| 30 | Riparian Zone Preservation | ✓ | ✓ | ✓ | ✓ | Preserve a native vegetation buffer to filter and slow runoff before entering sensitive (high risk) areas, most effective natural sediment control measure, slows runoff velocity, filters sediment from runoff, reduces volume of runoff on slopes | Freshly planted vegetation for newly created riparian zones requires substantial periods of time before they are as effective as established vegetation at controlling sediment |
| 32 | Scheduling | ✓ | ✓ | ✓ | ✓ | Identifies protection issues and plans for efficient, orderly construction of BMPs; minimizes bare soil exposure and erosion hazard; allows early installation of perimeter control for sediment entrapment; and early installation of runoff control measures | |
| 34 | Slope Texturing | ✓ | | | ✓ | Roughens slope surface to reduce erosion potential and sediment yield; suitable for clayey soils | Additional cost; not suitable for silty and sandy soils; not practical for slope length <8 m for dozer operation up/down slope |

Table 7.3: Erosion Control Measures – Source Control

| BMP # | BMP Name | Applications | | | | Comments | |
|-------|---|--------------|----------------------|--------------------------|---------------------------|---|--|
| | | Slopes | Ditches and Channels | Large Flat Surface Areas | Borrow and Stockpile Area | Advantages | Limitations |
| 36 | Polyacrylamide (PAM) | ✓ | ✓ | | ✓ | Increase cohesion of soil particles, thus enhancing terrestrial and aquatic habitat and improving water quality | Not for application to surface waters. Not commonly used in highway construction projects and may be expensive. Treatment area must be accessible to spray equipment. Temporary measure only. Performance decreases due to exposure to UV light and time |
| 35 | Straw Mulching & Crimping (Straw Anchoring) | ✓ | | | ✓ | Economical method of promoting plant growth and slope protection | Availability of straw. "Punching" of straw does not work on sandy soils. Application of straw by hand is labour intensive. If using straw blowers, treatment area must be accessible to trucks |
| 37 | Compost Blanket | ✓ | | ✓ | ✓ | Economical. Appropriate on slopes 2H:1V to level surface | Application on steep slopes may be difficult. Treatment area should be accessible to blower trucks |

Table 7.4: Erosion Control Measures – Runoff Control

| BMP # | BMP Name | Applications | | | | Comments | |
|-------|---------------------|--------------|----------------------|--------------------------|---------------------------|--|---|
| | | Slopes | Ditches and Channels | Large Flat Surface Areas | Borrow and Stockpile Area | Advantages | Limitations |
| 34 | Slope Texturing | ✓ | | ✓ | ✓ | Contouring and roughening (tracking) of slope face reduces runoff velocity and increases infiltration rates; collects sediment; holds water, seed and mulch better than smooth surfaces; promotes development of vegetation, provides reduction in soil erosion compared with untracked slopes | May increase grading costs, may cause sloughing in sensitive (wet) soils, tracking may compact soil, provides limited erosion control and should not be used as primary control measure |
| 21 | Offtake Ditch | ✓ | | ✓ | ✓ | Collects and diverts sheet flow or runoff water at the top of a slope to reduce downslope erosion, incorporated with permanent project drainage systems | Channel must be sized appropriately to accommodate anticipated flow volumes and velocities, lining may be required, may require design by qualified personnel, must be graded to minimize ponding |
| 17 | Energy Dissipator | ✓ | ✓ | | | Slows runoff velocity and dissipates flow energy to non-erosive level in relatively short distances, permits sediment collection from runoff | Small diameter rocks/stones can be dislodged; grouted riprap armouring may breakup due to hydrostatic pressures, frost heaves, or settlement; may be expensive, may be labour intensive to install; may require design by qualified personnel |
| 19 | Slope (Down) Drains | ✓ | | | | Directs surface water runoff into drain pipe or lined channel instead of flowing over and eroding exposed soils of slope face | Must be sized appropriately to accommodate anticipated flows, erosion can occur at inlet/outlet if protection is not incorporated into design, slope drain pipe must be anchored to slope |

Table 7.4: Erosion Control Measures – Runoff Control

| BMP # | BMP Name | Applications | | | | Comments | |
|-------|--|--------------|----------------------|--------------------------|---------------------------|---|---|
| | | Slopes | Ditches and Channels | Large Flat Surface Areas | Borrow and Stockpile Area | Advantages | Limitations |
| 2 | Gabions | | ✓ | | | Relatively maintenance free, permanent drop structure, long lasting, may be less expensive than riprap, allows smaller diameter rock/stones to be used, relatively flexible, commercially available products, commonly used in Alberta highway construction projects; suitable for resisting high flow velocity | Construction may be labour intensive (hand installation), extra costs associated with gabion basket materials |
| 7 | Rock Check Dam | | ✓ | | ✓ | Permanent drop structure with some filtering capability, cheaper than gabion or armouring entire channel, easily constructed, commonly used in Alberta highway construction projects | Can be expensive in areas of limited rock source, not appropriate for channels draining areas larger than 10 ha, requires maintenance after high flow storm events, can fail if water undermines or outflanks structure |
| 10 | Synthetic Permeable Barriers | | ✓ | | | Reusable/moveable, reduces flow velocities and dissipates flow energy; retains some sediments; used as grade breaks in conjunction with sturdy permanent drop structures along steep grades | Not to be used as check structures, must be installed by hand in conjunction with RECP, become brittle in winter and are easily damaged by construction equipment or recreational vehicles, only partially effective in retaining some sediment |
| 20 | Groundwater Control (Subsurface Drain) | ✓ | | | | Relief of subsurface groundwater seepage and winter ice build-up; lowers groundwater table to minimize piping erosion; enhances slope stability performance | Requires design by a qualified person; can be a slope instability issue |

Table 7.4: Erosion Control Measures – Runoff Control

| BMP # | BMP Name | Applications | | | | Comments | |
|----------|---|--------------|----------------------|--------------------------|---------------------------|--|---|
| | | Slopes | Ditches and Channels | Large Flat Surface Areas | Borrow and Stockpile Area | Advantages | Limitations |
| 38 28 | Rolls (Fibre) Wattles | ✓ | | | | Function well in freeze-thaw conditions, low cost solution to sheet flow and rill erosion on slopes, low to medium cost flow retarder and silt trap, can be used on slopes too steep for silt fences or straw bale barriers, biodegradable | Labour intensive to install (hand installation), designed for slope surfaces with low flow velocities, designed for short slope lengths with a maximum slope of 2H:1V, not currently widely used on Alberta highway construction projects |
| 4 | Continuous Perimeter Control Structures | ✓ | | ✓ | ✓ | Economical, no trenching required, flexible with continuous contact with ground. Appropriate on slopes 2H:1V to level surface | Application on steep slopes may be difficult. Treatment area should be accessible to blower trucks if installing compost berm |

7.5 Sediment Control BMPs

BMPs for sediment control are measures that have been proven to work on construction sites when they were properly planned and constructed. These measures reduce off-site sedimentation by promoting sedimentation before surface water leaves the construction site. There are generally two types of BMPs that can be used in conjunction with the minimum requirements:

- Filtering and Entrapment BMPs; and
- Impoundment BMPs.

Overall experience is an integral component in the successful selection of appropriate BMPs, and the design and implementation of an overall erosion and sediment control plan. It is the designer's responsibility to select BMPs which are appropriate for site conditions.

A sediment control plan may involve the use of bio-engineering methods. Bio-engineering methods can be permanent sediment control measures that involve using vegetation to promote sedimentation. The roots, stems and leaves promote sedimentation by reducing the velocity of water flow, with subsequent sedimentation of varying degrees depending on the sediment load, nature of sediments and reduction of flow velocity.

An overview of appropriate sediment control BMPs is presented in Table 7.5 with their respective advantages and limitations.

Filtering and Entrapment BMPs

Soil particles suspended in runoff can be filtered through porous media consisting of natural and artificial materials (i.e., vegetative strips, stone filters, man-made fibre filters). Filtering can be effectively applied to concentrated channel flows at inlets of permanent or temporary drainage systems and outlets of sedimentation ponds. This application requires careful maintenance to ensure continued effectiveness as sediment can clog these measures during storm events and/or during prolonged use.

Filtering is most effective when applied to unconcentrated sheet flow as a linear measure placed perpendicular to the direction of flow. Stream banks and the perimeter of regions of high-erosion potential are typical sites where filtering BMPs are employed for sediment control.

The most commonly used entrapment method is a silt fence. This measure is more effective for trapping particle sizes of fine, medium sand to coarse silt, depending on the mesh size used, for low flow velocity (<1.0 m/sec) and gentle grades (<3%). This method should only be used when there are **small runoff flow rates and volumes**; otherwise, its effectiveness will decrease and the system can be undermined or breached.

Check dams constructed from coarse granular material could be selected for steep grade situations where high flow velocity or volumes is anticipated.

Impoundment BMPs

The temporary impoundment of sediment-laden surface runoff lowers its internal energy by reducing flow velocity which promotes sedimentation. However, sedimentation may take a long time if the suspended sediments contain a significant portion of colloidal/clay or organic particles. This technique is normally applied to **concentrated flow** within the permanent or temporary drainage system of a site. Common types of impoundment structures are:

- Sedimentation basin/trap designed for a large runoff area; and
- Temporary barriers (synthetic weave barrier, rock check) along ditch or slope toe areas.

The design sediment containment is discussed in Section 12. A number of variations to the basic design can be used ranging from relatively small single basins to multiple interconnected basins.

Ideally, impoundment basins should be located within the site near the sediment source. Roadside ditches and old drainage channels can also be used as sediment impoundment areas upon installation of permeable or impermeable berms. Sediment traps/basins should be installed at the perimeter of the site, especially adjoining the sensitive environmental areas. Sedimentation traps/basins may be constructed by excavation and/or earth dyke construction, together with installation of a granular berm as an outlet flow structure. Where at all possible, the height of dykes or dams constructed to form impoundments should be kept as low as possible; otherwise dam safety considerations may apply. Correctly constructed and well maintained, sediment basins and traps can be an effective means of minimizing the quantity of sediment that is transported off-site. Regular maintenance and sediment removal will be required to ensure that adequate capacity and drainage is maintained.

Extended detention ponds allow runoff to be detained through slow release rates. Detention allows the sediment to settle out. Due to the slow release, these ponds are generally designed to be dry between runoff events. However, clogging of the outlet is the main concern due to the slow release rate. Therefore, the outlet should be protected or designed accordingly.

Table 7.5: Sediment Control Measures

| BMP Name | BMP # | Applications | | | | Comments | | |
|---|----------------------------|--------------|----------------------|--------------------------|---------------------------|------------|--|---|
| | | Slopes | Ditches and Channels | Large Flat Surface Areas | Borrow and Stockpile Area | Advantages | Limitations | |
| Filtering and Entrapment | Riparian Zone Preservation | 30 | ✓ | ✓ | ✓ | ✓ | Preserve a native vegetation buffer to filter and slow runoff before entering sensitive areas, most effective natural sediment control measure | Freshly planted vegetation for newly created riparian zones requires substantial periods of time before they are as effective as established vegetation at controlling sediment |
| | Straw Bale Barrier | 12 | | ✓ | ✓ | ✓ | Relatively inexpensive if bales are locally available, biodegradable, cheaper and easier to install than other barriers | Short service life due to biodegradation, straw bales may not be readily available in all areas of the province, maximum barrier height of one straw bale, require extensive maintenance after high flow storm events, require proper keying and staking |
| | Rolls (Fibre) | 38 | ✓ | | | | Function well in freeze-thaw conditions, low cost solution to sheet flow and rill erosion on slopes, low to medium cost flow retarder and silt trap, can be used on slopes too steep for silt fences or straw bale barriers, biodegradable | Labour intensive to install (hand installation), designed for slope surfaces with low flow velocities, designed for short slope lengths with a maximum slope of 2H:1V, not widely used on Alberta highway construction projects |
| | Wattles | 28 | | | | | | |
| Pumped Silt Control Systems (Silt Bags) | 31 | | ✓ | | | | Filter bag is lightweight and portable, simple set up and disposal, sediment-laden water is pumped into this filter bag, different aperture opening sizes (AOS) available from several manufacturers; normally for emergency use only | May be expensive, requires special design, not usually used in Alberta highway construction projects, requires a pump and power source for pump, suitable for only short periods of time and small volumes of sediment laden water, can only remove particles larger than aperture opening size (AOS) |

Table 7.5: Sediment Control Measures

| BMP Name | BMP # | Applications | | | | Comments | |
|--------------------------|----------------|--------------|----------------------|--------------------------|---------------------------|--|---|
| | | Slopes | Ditches and Channels | Large Flat Surface Areas | Borrow and Stockpile Area | Advantages | Limitations |
| Silt Fence | 1 | ✓ | | ✓ | ✓ | Economical, most commonly used sediment control measure allows water to pond and settle out coarse grained sediment, more effective than straw bale barriers | May fail under high runoff events, applicable for sheet flow erosion only, limited to locations where adequate space is available to pond collected runoff, sediment build up needs to be removed on a regular basis, damage to silt fence may occur during sediment removal, usable life of approximately one year |
| Berm Interceptor | 5 | ✓ | | ✓ | ✓ | Easy to construct, relatively inexpensive as local soil and material is used | Geotechnical design required for fill heights in excess of 3 m, may not be suitable for all soil types or sites; riprap spillway and/or permeable outlet may be required |
| Filtering and Entrapment | Gabions | 2 | ✓ | | | Relatively maintenance free, permanent drop structure, long lasting (robust), may be less expensive and thickness than riprap, allows smaller diameter rock/stones to be used, relatively flexible, commercially available products, commonly used in Alberta highway construction projects; suitable for resisting high flow velocity | Construction may be labour intensive (hand installation), extra costs associated with gabion basket materials |
| | Rock Check Dam | 7 | ✓ | | ✓ | Permanent drop structure with some filtering capability, cheaper than gabion and armouring entire channel, easily constructed, commonly used in Alberta highway construction projects | Can be expensive in areas of limited rock source, not appropriate for channels draining large areas, requires extensive maintenance after high flow storm events, susceptible to failure if water undermines or outflanks structure |

Table 7.5: Sediment Control Measures

| BMP Name | BMP # | Applications | | | | Comments | | |
|--------------------------|---|--------------|----------------------|--------------------------|---------------------------|------------|--|---|
| | | Slopes | Ditches and Channels | Large Flat Surface Areas | Borrow and Stockpile Area | Advantages | Limitations | |
| Filtering and Entrapment | Synthetic Permeable Barriers | 10 | | ✓ | | | Reusable/moveable, reduces flow velocities and dissipates flow energy; retains some sediments; used as grade breaks in conjunction with sturdy permanent drop structures along steep grades | Partially effective as check dam structure, must be installed by hand in conjunction with RECP, become brittle in winter and are easily damaged by construction equipment or recreational vehicles, only partially effective in retaining some sediment, primarily used for reducing flow velocities and energy dissipation |
| | Continuous Perimeter Control Structures | 4 | ✓ | | ✓ | ✓ | Temporary measure; divert and intercept sheet or overland flow to form pond and allow sedimentation; no trenching | Require specialized continuous berm machine to manufacture earth-filled geotextile berm on site; sandy/gravel soil is preferable fill material |
| | Storm Drain Inlet/Sediment Barrier | 6 | | | ✓ | | Temporary measure; easy to install and remove | Limited sediment entrapment capacity; requires regular clean-out maintenance |
| | Compost Blanket | 37 | ✓ | | ✓ | ✓ | Economical. Appropriate on slopes 2H:1V slope or flatter | Application on steep slopes may be difficult. Treatment area should be accessible to blower trucks |
| All BMPs | Scheduling | 32 | ✓ | ✓ | ✓ | ✓ | Identifies protection issues and plans for efficient, orderly construction of BMPs; early installation of perimeter control for sediment entrapment; early dimension planning of sediment control measures | |

Table 7.5: Sediment Control Measures

| BMP Name | BMP # | Applications | | | | Comments | |
|--------------------------------------|-------|--------------|----------------------|--------------------------|---------------------------|---|---|
| | | Slopes | Ditches and Channels | Large Flat Surface Areas | Borrow and Stockpile Area | Advantages | Limitations |
| Impoundment Sediment Traps/Basins | 18 | | ✓ | | ✓ | May be constructed of a variety of materials, collects sediment laden runoff and reduces velocity of flow and deposition of sediment, can be cleaned and expanded as needed, capable of handling large volumes of sediment laden runoff | “Last resort” measure. Normally requires 250 m ³ /ha storage volume per area of exposed soil, Can require large areas of land, requires periodic maintenance to remove sediment build up, requires design by qualified personnel, usually requires 'back-up' control measures in case pond/basin overflows |

7.6 Selection Considerations for Bio-engineering Methods

The following should be evaluated when bio-engineering methods are considered for use in an erosion and sediment control plan:

- **Transport of Weeds** The consultant and contractor responsible for design and implementation of bio-engineering methods must minimize the risk of damaging, invasive or foreign species of plants being introduced into a new area from an infested area. A Professional Agrologist should be consulted as to the suitability of plant species for use in bio-engineering methods.
- **Availability of Suitable Plants** An area where suitable plants for use in bio-engineering methods must be within an economical distance from the proposed construction site. Permission to harvest plants from other locations must be obtained if suitable species or quantities of plants are not available within the limits of the proposed construction site.
- **Mechanical and Hydrological Benefits of Plant Systems** The root systems strengthen with time and reduce available moisture, however when initially installed, the plants used in bio-engineering are usually dormant and provide no immediate mechanical or hydrological benefit. However, the process of installation (benching) helps reduce erosion and promotes plant growth.
- **Use of Indigenous Materials** The plants must be well suited to climate, soil and moisture conditions of a site. Harvest sites should have similar characteristics to the planting site. Large variations in the bio-geoclimatic regimes such as elevation, drainage, soil type, slope aspect, and temperature will increase plant mortality and decrease the effectiveness of the bio-engineering system.
- **Labour / Skill Requirements** Crews can be easily trained to install bio-engineering systems and the capital / energy requirements are typically low. Bio-engineering can be installed using heavy equipment, however the harvesting and installation of the living plant material is conducive to a non-mechanized labour force working on sensitive sites that limit heavy equipment use.
- **Costs** The majority of bio-engineering costs are usually associated with labour. Labour costs can be substantial because plant material must be harvested, prepared, installed and tended, usually by hand. Transportation and storage, if required, of living plants is also a cost consideration. In some cases, large refrigerated facilities are required to properly store living plant material for extended periods between harvesting and planting.
- **Environmental Compatibility** Selected properly, the plants selected provide non-intrusive systems that enhance aesthetics as well as fish and wildlife habitat. It is important to recognize the site sensitivities before selecting plants to be used in bio-engineering. Harvesting plant species that are well climatized and appropriate to the installation site will provide the most effective bio-engineering results.

- **Access** Bio-engineering methods can be the most appropriate choice for sites with poor access such as riparian zones or sensitive stream embankments. Difficult sites can be accessed with minimal impact, however poor site access will increase costs associated with transportation and handling since machinery may not be able to support the labour force. For sites where access is good, heavy equipment can support bio-engineering installation by transportation of supplies and equipment and preparation of earthworks.
- **Timing** Bio-engineering methods are most effective when plant stock is harvested during the dormant seasons (late fall or early spring). Energy stored within the plant during dormancy provides the best opportunity for the plant to establish roots when it is placed in soil. Plants that are harvested while in a growth period suffer higher mortality since the plant has already gone into leaf production and harvesting shocks the plant system. Plants can effectively be harvested during a dormant period, cold stored and then planted when the soil has warmed.
- **Maintenance Requirements** Depending on the site, certain levels of maintenance are required. Supplemental plant stock may be required if minimum coverage of plant growth is not achieved by a certain time in the project schedule. Conversely, bio-engineering systems that experience heavy growth may require trimming particularly on projects where sight lines are important.

8.0 SELECTION OF BMP FOR EROSION AND SEDIMENT CONTROL

8.1 Preliminary Tasks

The following tasks should be completed before erosion and sediment control measures are selected for a given site:

- Conduct the Site Assessment (Section 5.0);
- Conduct the Site Evaluation (Section 6.5);
- Site Hazard Classification (Section 6.5.3); and
- Connectivity to Downstream Resources (Section 6.5.4).

The order in which these tasks should be completed is presented as a flow chart in Figure 8.1.

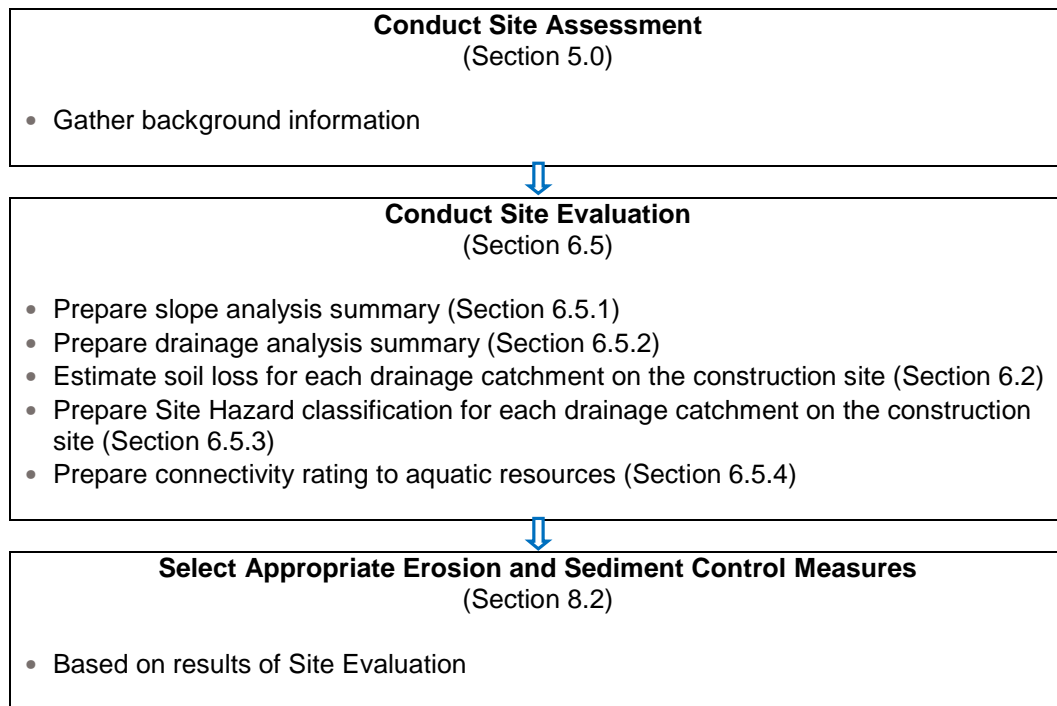

Figure 8.1: Steps in Preparing an Erosion and Sediment Control Plan

8.2 Guidelines for Selecting Appropriate Erosion and Sediment Control Measures

Failure of erosion and sediment control measures can result in three types of potential consequences:

- Ecological consequences, related to the introduction of sediment to the aquatic environment. This is related to the connectivity to aquatic resources (see Table 6.2).

- Project consequences, related to the need to repair erosion damage and the implications for project schedule and cost; and
- Legal consequences, associated with the deposition of sediment in receiving waterbodies.

The aim in selecting, designing, and constructing the appropriate erosion and sediment control measures is to reduce the risk of these negative consequences.

Following the site assessment and evaluation, the information required to adequately select the erosion and sediment control measures for preparing an ESC Plan will be available. Selection of BMPs and other measures can be guided by a combination of the site erosion potential, the consequences of erosion and sediment control, as well as the experience and judgement of the designer.

A summary of the BMPs and other measures required based on site erosion potential and consequences of erosion and sedimentation is presented in Table 8.1.

Table 8.1: Required Levels of Erosion and Sediment Control

| Erosion Potential | Consequences of Erosion and Sedimentation | Level of Erosion and Sediment Control (BMPs and Other Measures) | | | | | |
|-----------------------------|---|---|------------------------------|--------------------------|--|--------------------------------------|--------------------------|
| | | Procedural BMPs and Planning Strategy | ESC Plan and Structural BMPs | Water Management BMPs | Staged Construction and Progressive Rehabilitation | More Intensive Sediment Control BMPs | Water Quality Monitoring |
| Low | Low | Recommended ^b | - | - | - | - | - |
| | High | Required | Required | - | - | - | - |
| Moderate | Low ^a | Required | - | - | - | - | - |
| | High | Required | Required | Recommended ^b | Recommended ^b | Recommended ^b | Recommended ^b |
| High | Low ^a | Required | Required | Required | Required | Required | Recommended ^b |
| | High | Required | Required | Required | Required | Required | Required ^c |
| Reference in Manual Section | | 7.2 | 7.3, 7.4, 8.0 | 7.3 | 7.2, 7.2.1 | 7.5 | 9.9 |

Source: Transportation Association of Canada, 2005

- Notes:
- If economically justified, it may be acceptable to limit ESC measures for low-consequence projects, including those distant from sensitive areas, to procedural BMPs only.
 - This level of ESC should be implemented where practical. For example, a small, short-duration project may not require staged construction and progressive rehabilitation. Recommended actions may be necessary to demonstrate due diligence in the event of the release of sediment due to an extreme runoff event.
 - Water quality monitoring provides a quantitative measurement of the effectiveness of ESC measures. Monitoring may be required by regulatory agencies.

The information presented in Table 8.1 must be supplemented with the designers experience and judgement during the preparation of the erosion and sediment control strategy. Those responsible for the design and implementation of BMPs and other measures should continue to utilize innovative approaches which best address specific situations. Advances in technology will also continue to improve the methods and materials that are currently employed. Reference should be made to AT's Products List for the most up-to-date approved products (www.transportation.alberta.ca/689.htm).

Specific measures and BMPs are published in many manuals and standards, which describe criteria and specifications in detail. Many of the BMPs most commonly used in Alberta are presented in Appendix C. The BMPs are listed in terms of erosion control and sediment control, and the description, typical applications, advantages and limitations for each are provided. For each BMP, installation information and construction, maintenance and inspection considerations are provided. Where applicable, similar measures are also noted to provide the designer with options and flexibility in choice.

Other factors effecting the selection of erosion and sediment control BMPs include:

- Site Specific Design Requirements;
- Specific Construction Requirements including available space;
- Regulatory laws and guidelines; and
- Cost.

8.3 Construction Phase Activities

Erosion control considerations for various construction phase activities are presented as follows. These construction-related activities must be addressed in the contractor's ECO Plan.

Clearing and Grubbing

Clearing operations include slashing, cutting, stockpiling, and removal (or burning) of trees and brush. Clearing operations leave the stump and root mass intact, as well as the organic mat in the soil. Grubbing operations include the removal of the tree stumps and root masses left behind during clearing operations, however, the topsoil and the majority of the organic mat remains in place. Grubbing operations may cause localized soil exposure in areas where roots and stumps were removed.

Stripping

Stripping is the removal of the organic mat from the construction site to expose the underlying mineral soil. The exposed soil will be disturbed during the stripping operation, thereby increasing the erosion potential.

Borrow Excavations

These are excavations outside of the road right-of-way, made solely for the purpose of removing borrow material for:

- Roadway subgrade construction, or
- The construction of a dam, canal, dike, structure or erosion protection works associated with a provincial water management infrastructure project which may be connected with the borrow excavation.

Borrow excavations can either be landscape borrows or dugout borrows. Landscape borrows can be topographical highs such as hills or ridges, or if utilized on relatively flat terrain a maximum of 1m in depth and must be free draining. Dugout borrows are large excavations utilized for the extraction of construction material with the excavated area

being returned to an “equivalent land capability” as required by Provincial Legislation, which may include holding water.

Development of borrow excavations may include clearing, stripping, grubbing and excavation. The development of borrow excavations and haul roads may cause soil disturbance, create exposed slopes and/or alter the natural drainage courses in the vicinity of the borrow excavation.

Stockpiles

Stockpiles may include material removed from excavations, stripping, clearing, and from borrow pits. The creation of stockpiles may disturb the vegetated soil surface, create exposed slopes, and/or alter the natural drainage courses.

Cut Slope Construction

Cut slopes are slopes created through the excavation and removal of native soil. Cut slopes may increase the slope angle, disturb the soil surface, create exposed slopes, and/or alter the natural drainage courses.

Fill Slope Construction

Fill (embankment) slopes are constructed by placing and compacting fill material. Embankments may create disturbed exposed slopes, create steep slope angles, and/or alter the natural drainage courses.

Ditch Construction

Where channels or ditches are constructed to direct and transport water along or transverse to the highway alignment, the original drainage pattern may be altered and concentration of flows created thereby increasing flow velocity and erosion potential. Ditch construction creates exposed slopes which can be eroded.

Culvert Installation

Culverts are installed to connect drainage courses and surface drainage flow. Installation of culverts may cause flow concentrations, create cut slopes, disturb the soil surface on slope faces, and create scour zones at the culvert inlet or outlet.

Temporary Access Road Construction

Temporary access roads are constructed to accommodate construction equipment on the project site. Construction of temporary haul roads may alter drainage courses and may include the construction of cut slopes, fill slopes, ditches or culvert installation.

8.4 Selection of Best Management Practice (BMP) According to Construction Activity

A large number of erosion and sediment control BMPs are available for use in an erosion and sediment control plan. The BMPs presented in this section have been proven to be effective when properly implemented. Since effective implementation of control measures is a site-specific operation, the BMPs have been grouped by typical construction activities that occur on highway construction sites in Table 8.2. BMPs

typically used for streambank stabilization applications are summarized in Tables 8.3 and 8.4.

Site conditions may be such that the BMPs presented in this guideline are not appropriate. As such, modified methods and techniques may be required to meet the specific requirements of any given construction site. Erosion and sediment controls to be considered should be easy to design, implement, maintain and inspect.

Table 8.2: Application for BMPs Based on Construction Activities

| BMP Name | Construction Activity | | | | | | | | | |
|---|-----------------------|-----------|-------------|------------|------------|-------------|------------------|----------|----------------------|--|
| | Clearing and Grubbing | Stripping | Borrow Pits | Stockpiles | Cut Slopes | Fill Slopes | Ditches/Channels | Culverts | Temporary Haul Roads | |
| 1. Silt Fence | ✓ | ✓ | ✓ | ✓ | ✓ | ✓ | | ✓ | ✓ | |
| 2. Gabions | | | | | | | ✓ | ✓ | | |
| 4. Continuous Perimeter Control Structures | ✓ | ✓ | ✓ | ✓ | ✓ | ✓ | | | ✓ | |
| 5. Berm Interceptor | ✓ | ✓ | ✓ | ✓ | ✓ | ✓ | | | ✓ | |
| 6. Storm Drain Inlet | | | | | | | ✓ | ✓ | | |
| 7. Rock Check | | | | | | | ✓ | | | |
| 10. Synthetic Permeable Barrier | | | | | | | ✓ | | | |
| 12. Straw Bale Barrier | | | ✓ | ✓ | ✓ | ✓ | | | ✓ | |
| 13. Rolled Erosion Control Products (RECP) | | | | ✓ | ✓ | ✓ | ✓ | | | |
| 14. Riprap Armouring | | | | | | | ✓ | ✓ | | |
| 15. Cellular Confinement System | | | | | ✓ | ✓ | ✓ | | | |
| 17. Energy Dissipators | | | | | | | ✓ | ✓ | | |
| 18. Sediment Traps and Basins | | ✓ | | | | | ✓ | | | |
| 19. Slope Drains | | | | | ✓ | ✓ | | | | |
| 20. Groundwater Control | | | ✓ | | ✓ | ✓ | | | | |
| 21. Offtake Ditches | | ✓ | ✓ | ✓ | ✓ | ✓ | | | | |
| 22. Seeding | | | ✓ | ✓ | ✓ | ✓ | ✓ | | | |
| 23. Mulching | | | ✓ | ✓ | ✓ | ✓ | ✓ | | | |
| 35. Straw Mulching and Crimping (Straw Anchoring) | | | ✓ | | ✓ | ✓ | | | | |
| 24a. Hydroseeding | | | ✓ | ✓ | ✓ | ✓ | ✓ | | | |
| 24b. Hydromulching | | | ✓ | ✓ | ✓ | ✓ | ✓ | | | |
| 25. Topsoiling | | | ✓ | ✓ | ✓ | ✓ | ✓ | | | |
| 26. Sodding | | | ✓ | ✓ | ✓ | ✓ | ✓ | | | |

SECTION 8 - SELECTION OF BMP FOR EROSION AND SEDIMENTATION CONTROL

| BMP Name | Construction Activity | | | | | | | | |
|-----------------------------------|-----------------------|-----------|-------------|------------|------------|-------------|------------------|----------|----------------------|
| | Clearing and Grubbing | Stripping | Borrow Pits | Stockpiles | Cut Slopes | Fill Slopes | Ditches/Channels | Culverts | Temporary Haul Roads |
| 27a. Live Staking | | | | | ✓ | ✓ | ✓ | | |
| 30. Riparian Zone Preservation | ✓ | ✓ | ✓ | ✓ | ✓ | ✓ | ✓ | ✓ | ✓ |
| 31. Pumped Silt Control Systems | | | | | | | ✓ | ✓ | |
| 32. Scheduling | ✓ | ✓ | ✓ | ✓ | ✓ | ✓ | ✓ | ✓ | ✓ |
| 33. Stabilized Worksite Entrances | ✓ | ✓ | ✓ | ✓ | ✓ | ✓ | ✓ | ✓ | ✓ |
| 34. Slope Texturing | | | ✓ | ✓ | ✓ | ✓ | | | ✓ |
| 36. Polyacrylamide (PAM) | | | ✓ | | ✓ | ✓ | ✓ | | |
| 37. Compost Blanket | | | | ✓ | ✓ | ✓ | | | ✓ |
| 38. Rolls (Fibre) | | | ✓ | ✓ | ✓ | ✓ | | | |

Table 8.3: BMPs for Streambank Applications

| BMP # | BMP Name | Category | Also Known As |
|-------|--|----------------------------|--|
| 38. | Rolls (Fibre) | Bank Armour and Protection | Coir Rolls and Coir Mats |
| 27a. | Live Staking | River Training | Live Staking |
| 27b. | Brushlayering | River Training | Live Brushlayering |
| 39. | Brush Mattress | Bank Armour and Protection | Live Brush Mattress, Brush Mat |
| 40. | Live Siltation | River Training | Vertical Brushlayering |
| 41. | Willow Posts & Poles | River Training | Pole Planting, Dormant Live Posts |
| 42. | Rock Vanes | River Training | Rock Vanes, Upstream Angled Spurs |
| 43. | Longitudinal Stone Toe | River Training | Longitudinal Peaked Stone Toe Protection (LPSTP), Stone Toe, Rock Toe, Stone Toe Buttress, Weighted Riprap Toe, Longitudinal Fill Stone Toe Protection (LFSTP) |
| 44. | Vegetated Mechanically Stabilized Earth (VMSE) | River Training | Vegetated Geogrids, Brushlayering with Soil Wraps, Vegetated Geofabric Wrapped Soil |
| 45. | Vegetated Riprap | Bank Armour and Protection | Vegetated Rock Revetment, Vegetated Rock Slope Protection (VRSP), Face Planting, Joint Planting |

Note: Adapted from E-SenSS Software, 2005, Salix Applied Earthcare

Table 8.4: BMPs for Streambank Applications Based on Erosion Process

| | BMP 38 Roll (Fibre) | BMP 27a Live Staking | BMP 27b Brushlayering | BMP 39 Brush Mattress | BMP 40 Live Siltation | BMP 41 Willow Posts & Poles | BMP 42 Rock Vanes | BMP 43 Longitudinal Stone Toe | BMP 44 VMSE | BMP 45 Vegetated Riprap |
|--|------------------------|-------------------------|--------------------------|--------------------------|--------------------------|-----------------------------------|----------------------|-------------------------------------|----------------|----------------------------|
| Erosion Process | | | | | | | | | | |
| Toe erosion with upper bank failure | ✓ | | | | ✓ | | ✓ | ✓ | | ✓ |
| Scour of middle and upper banks by currents | | ✓ | ✓ | ✓ | ✓ | ✓ | ✓ | | ✓ | ✓ |
| Local scour | ✓ | ✓ | ✓ | ✓ | ✓ | ✓ | ✓ | | | ✓ |
| Erosion of local lenses or layers of non-cohesive sediment | ✓ | ✓ | ✓ | ✓ | ✓ | ✓ | | | ✓ | ✓ |
| Erosion by overbank runoff | | | ✓ | | | | | | | |
| General Bed Degradation | | | | | | | | | | |
| Headcutting | | | | | | | | | | |
| Piping | | | | | | | | | | |
| Erosion by navigation waves | ✓ | ✓ | | | ✓ | ✓ | | | | ✓ |
| Erosion by wind waves | ✓ | ✓ | | | ✓ | ✓ | | | | ✓ |
| Erosion by ice and debris gouging | ✓ | | | | | | | ✓ | | ✓ |
| General bank instability or susceptibility to mass slope failure | | ✓ | ✓ | | | | | ✓ | ✓ | |
| Spatial Application | | | | | | | | | | |
| Instream | | | | | | | ✓ | | | |
| Toe | ✓ | | | ✓ | ✓ | | ✓ | ✓ | | ✓ |
| Midbank | | ✓ | ✓ | ✓ | | ✓ | | | ✓ | ✓ |
| Top of bank | | | | ✓ | | | | | | ✓ |
| Hydrologic / Geomorphic Setting | | | | | | | | | | |
| Resistive | ✓ | | | ✓ | | | | ✓ | ✓ | ✓ |
| Redirective | | | | | | | ✓ | | | |
| Continuous | | | | ✓ | ✓ | | | ✓ | ✓ | ✓ |
| Discontinuous | | | | | | | ✓ | | ✓ | |
| Outer Bend | ✓ | | | ✓ | ✓ | | ✓ | ✓ | ✓ | ✓ |
| Inner Bend | | | | ✓ | | | | | ✓ | |
| Incision | | | | | | | | ✓ | | |
| Lateral Migration | ✓ | | | | | | ✓ | | | ✓ |
| Aggradation | | | | | ✓ | | ✓ | | | |
| Complexity | | | | | | | | | | |
| Low | | | | | ✓ | ✓ | | ✓ | | |
| Moderate | ✓ | ✓ | ✓ | ✓ | | | ✓ | | | ✓ |
| High | | | | | | | | | ✓ | |

Note: Adapted from E-SenSS Software, 2005, Salix Applied Earthcare

THIS PAGE LEFT BLANK INTENTIONALLY.

9.0 THE PERMANENT EROSION AND SEDIMENT CONTROL PLAN (PESC PLAN)

9.1 General

The Permanent Erosion and Sediment Control (PESC) Plan constitutes the measures designed by the consultant to be implemented by the contractor as part of the construction contract to address long term post construction erosion and sedimentation issues. The PESC Plan should be designed using an engineering approach based on acceptable principles of soil mechanics and open channel flow hydraulics. The PESC Plan will also be referenced by the construction contractor in the development of the Environmental Construction Operations (ECO) Plan.

A PESC Plan should be prepared for all construction projects. For sites smaller than 2 ha (and not connected to an environmentally sensitive area), this consists of identifying minimum requirements for an erosion and sediment control strategy, and where practical, implementing erosion and sediment controls to reduce on-site runoff and erosion. Sites larger than 2 ha require the development of a comprehensive PESC Plan and associated documents. During construction, the PESC Plan should be reviewed by the consultant and modified as required as field conditions change.

9.2 Consultant Responsibility

The consultant is required to prepare and submit:

- A PESC Plan Report;
- Design and Construction Drawings showing PESC measures where appropriate;
- Contract special provisions which may be necessary to identify and address special areas of concern or types of work; and
- As-Built drawings showing the type, quantity and location of PESC measures installed.

The consultant is also responsible to monitor construction and confirm that the permanent erosion control works are installed according to the requirements of the PESC Plan.

The required qualifications of the Consultant are provided in Section 3.1.3.

9.3 PESC Plan Documentation

The PESC Plan must include a report and drawings. Reference should be made to Alberta Transportation's Engineering Consultant Guidelines for Highway and Bridge Projects. As a minimum the following should be addressed in the PESC Plan:

- Site Assessment;
- Design of the PESC Plan including highlighting procedural or minimum requirements, required BMPs and site specific designs;
- Shut Down considerations;
- Inspection, Monitoring and Maintenance Requirements;

- Emergency Response Plan and incident reporting requirements; and

A checklist for the development of the PESC Plan is included in Appendix D.

9.4 Design and Construction Drawings

The Design and Construction Drawings must show the PESC measures (where appropriate) and reference the PESC Plan report.

9.5 Contract Special Provisions

Contract Special Provisions shall discuss other special or site specific items not included in the Standard Specifications for Highway Construction. Information which may be included in the Special Provisions are design location of the devices, quantities and special regulatory requirements, or reference to special instructions on installing the erosion and sediment control devices.

9.6 Site Inspection During Construction

Once the PESC measures have been installed, it is important that their effectiveness is monitored and necessary maintenance be carried out. The success of the entire erosion and sediment control strategy will depend upon this, and its importance cannot be overemphasized.

All PESC measures must be inspected by the contractor daily and following heavy rainstorms or snowmelt events during the construction phase. Immediate action must be taken by the contractor when the need for maintenance or repair of PESC measures is identified for the ongoing performance of the measures.

The Consultant should inspect the PESC measures every 7 days and following heavy rainstorms or snowmelt events and advise the contractor immediately of any areas of concern. As site work progresses, the PESC Plan should be modified when necessary by the Consultant to reflect changing site conditions or new information which has been identified during construction.

A copy of the PESC Plan, along with a copy of the Construction Drawings, must be kept by the Contractor at the construction site for use by construction and inspection personnel.

9.7 Inspection and Incident Records

The Contractor and Consultant must both maintain separate records of their inspection of all ESC measures at the frequencies noted above, including notes regarding damage and deficiencies observed. The same document can be used to record maintenance and repairs undertaken after the inspection.

The Consultant must submit their inspection report of ESC measures to AT on a weekly basis. The contractor must maintain records of their daily inspection and provide copies to the consultant if and when requested.

Sample inspection report forms are presented in Appendix D.

9.8 As-Built Drawings and Project Records

A complete summary of the PESC measures installed must be documented by the Consultant during construction and updated as various measures modified. As-built drawings and supporting records must include a plan view drawing showing the type, quantity and location of PESC measures installed.

Supplemental information which should be included in the Final Details includes:

- Inspection and Maintenance Reports;
- Modifications to the PESC Plan;
- Photos of the installed PESC measures; and
- Incident Reports.

9.9 Post Construction

After final acceptance, the inspection and maintenance responsibilities of the PESC measures will be transferred from the construction contractor to the Maintenance Contract Inspector (MCI) and AT's Maintenance Contractor.

The respective maintenance responsibilities at the Construction Phase and Post Construction Phase are described in Construction Bulletin #12, which is available on Alberta Transportation's website at www.transportation.alberta.ca/920.htm.

Inspection and maintenance of PESC measures must continue regularly so that the measures remain effective in the long term. The following circumstances and conditions will permit BMPs to be removed:

- Revegetation of bare soil is successful;
- No obvious erosion scour is observed;
- No obvious bed load of silt and sediment laden runoff is observed;
- Inspection and maintenance report indicates satisfactory performance for past 3 years; and
- AT maintenance staff will assess and decide on performance of the structures and requirement for necessary removal.

THIS PAGE LEFT BLANK INTENTIONALLY.

10.0 THE TEMPORARY EROSION AND SEDIMENT CONTROL PLAN (TESC PLAN)

10.1 General

The temporary erosion and sediment control plan (TESC Plan) constitutes the measures designed and installed by the contractor to address matters of erosion and sediment control which the contractor anticipates during the construction contract and includes activities up to the point of final acceptance of the construction work. The TESC Plan is prepared by the contractor and forms one component of the ECO Plan which is also prepared by the contractor.

10.2 Contractor's Responsibility

The contractor is required to prepare and submit an ECO Plan to the consultant prior to construction. In order to develop a proper TESC Plan, the contractor should incorporate recommendations of the consultant's PESC Plan and Environmental Risk Assessment.

Responsibilities of the Consultant and Contractor as well as the guidelines on preparing an ECO Plan are outlined in the most current version of the ECO Plan Framework which can be found on Alberta Transportation's website at <http://www.transportation.alberta.ca/571.htm>.

10.3 TESC Plan Documentation

As a minimum, the following should be addressed in the TESC Plan:

- Design of the TESC Plan including addressing procedural or minimum requirements, required BMPs and site specific designs;
- Shut Down considerations;
- Inspection, Monitoring and Maintenance requirements; and
- Emergency Response Plan and incident reporting requirements.

10.4 Site Inspection During Construction

During construction, before final acceptance of the construction contract works, the responsibility for the inspection, maintenance and repair of all TESC measures lies with the contractor. A schedule of planned maintenance activities is required with the submission of the ECO Plan. When implemented controls are insufficient or not working as intended, changes to the TESC Plan component must be made by the contractor to ensure continued compliance.

All erosion and sediment control measures must be inspected daily by the contractor and following heavy rainstorms or snowmelt events. Some measures will require periodic replacement and/or removal of accumulated sediment.

Damage or deficiencies to control measures should be corrected immediately.

Details on inspection, maintenance and repair activities shall be recorded on the "Inspection and Maintenance Form" presented in Appendix D.

10.5 Shutdown Considerations

The TESC Plan must include provisions for erosion and sediment control during shutdown periods. Shutdowns are considered any extended period of time during which the contractor is not actively developing the project site and may no longer have personnel or equipment on-site. Shutdowns may or may not be planned and may result from seasonal work stoppages, adverse weather events, or contractual disagreements.

During a shutdown, erosion and sediment control measures must still be inspected and maintained. This will include during winter shutdown and more importantly, during spring snow melt prior to construction re-start when the contractor must provide timely, regular monitoring and maintenance as well as install additional measures as necessary.

10.6 Emergency Response Plan

The TESC Plan must show preparedness for an emergency response to erosion and sediment related problems. The contractor should reference the most current versions of the ECO Plan Framework and EMS Manual and should also reference the consultant's PESC Plan for information on requirements and procedures.

10.7 Inspection and Incident Reports

All inspection, maintenance and repairs performed on erosion and sediment control measures should be recorded on the "Inspection and Maintenance Form" presented in Appendix D. Inspection and maintenance report and repair records must be kept at the construction site for review by construction personnel, inspectors, consultants and AT.

10.8 Post Construction

After final acceptance, the inspection and maintenance responsibilities of any installations that must remain in operation will be transferred from the construction contractor to the Maintenance Contract Inspector (MCI) and AT's Maintenance Contractor in the post construction phase. The respective maintenance responsibilities at the Construction Phase and Post Construction Phase are described in Construction Bulletin #12, which is available on Alberta Transportation's website at www.transportation.alberta.ca/920.htm.

Inspection and maintenance must continue until the BMP is no longer required, at which time the BMP will have to be properly removed. The following circumstances and conditions will permit BMPs to be removed:

- Revegetation of bare soil is successful;
- No obvious erosion scour is observed;
- No obvious bed load of silt and sediment laden runoff is observed; and
- AT maintenance staff will assess and decide on performance of the structures and requirement for necessary removal.

11.0 GUIDELINES FOR ESTIMATING RUNOFF FROM SMALL WATERSHEDS AND DESIGN OF OPEN CHANNELS

11.1 General

The design of erosion and sediment control measures should consider the peak flow rate of surface runoff to ensure channels and sedimentation containment systems are adequately sized. Furthermore, these structures must be protected from erosion due to concentrated water flow.

Channelized flow requires provision of erosion control measures to prevent concentrated water flow from causing erosion. The amount of runoff laden with sediment will influence the design requirements for sediment control. The estimate of runoff from small watersheds and the design of channel lining are presented below.

11.2 Estimating Runoff from Small Watersheds

The amount of runoff from each catchment on a highway construction project site is related to the design rainfall storm and catchment area affected by construction. The highway drainage design generally includes ditches and cross-drainage culverts as well as stormwater storage/treatment areas and floodplain considerations.

For the design of erosion and sedimentation protection measures, the understanding of runoff estimation is an important design consideration. The runoff assessment should be provided by a qualified hydrology professional or engineer. For small catchment areas, the guidelines for the estimate of runoff are presented in Appendix E. These guidelines should only be used in conjunction with professional judgement and experience. For major watercourse crossings, the drainage assessment is generally provided by a qualified hydrotechnical bridge engineer.

11.3 Design of Open Channels

Open channels are the system of culverts, ditches and swales that convey concentrated drainage on a highway construction site. These channels must be designed to contain design runoff flow without overtopping. Furthermore, open channels must be able to convey the concentrated flows without promoting additional erosion within the channel. Open channel design should be provided by a qualified hydrology professional or engineer.

The use of permissible tractive resistance has been adopted for the design of channel lining instead of the permissible velocity concept which was historically used by some designers. For highway ditch/channel and a simplified flow regime, the channel design is a function of runoff, geometric channel properties and channel roughness (n).

The channel roughness (n) is dependent on the degree of irregularity of the wetted perimeter of open channel flow which may be influenced by erosion control BMPs in the channel. The protective linings for channels can include soft armour linings of different materials (i.e., vegetation, mulch, soil coverings or erosion protection matting, etc.) and hard armour linings (i.e., gabion, riprap, concrete lining, pipe, etc.), all of which will affect " n ".

Simplified guidelines for design of highway channels and channel roughness (n) values for various protective channel lining materials are presented in Appendix F. These guidelines should only be used in conjunction with professional judgement and experience.

12.0 GUIDELINES FOR THE DESIGN OF SEDIMENT CONTAINMENT

12.1 General

The function of a sediment containment system is to provide storage capacity to runoff volume and to slow the flow velocity of runoff to allow the sedimentation of suspended soil particles to occur. When designed correctly, most sediment containment systems do one or more of the following:

- Provide containment storage volume for incoming runoff waters;
- Create uniform flow zones, increased flow path length and width and increased sedimentation times to facilitate sedimentation of suspended particles; and
- Discharge water at a controlled rate that permits adequate detention time for sedimentation of suspended particles.

It is important to note that 100% reduction of all incoming suspended particles is not feasible due to practical limits of storage space and available settling time. Therefore, the efficiency of a containment system is based on the efficiency of sedimentation of a target soil grain size.

The sediment containment system should be designed so that the outflow rate during the design rainfall event is equal to or smaller than the inflow rate of sediment-laden runoff. Coarse to medium size silt particles (particle size range 75 μm to 20 μm) can be realistically targeted for sedimentation. Finer size particles (i.e., clay and fine silt) will require a long time to settle and therefore may not be deposited in the sediment containment facility during the time of retention. As such, targeting clay, fine silt particles and organic silts for sedimentation is generally not practical.

The design capacity of a sediment containment system should be sufficient to impound the runoff volume collected from an area of disturbed land (bare soil) for a 1:2 year storm event of 24 hour rainfall intensity or a recommended runoff volume of 250 m^3 per hectare of disturbed land. Under conditions of land constraints, a minimum runoff volume of 150 m^3 per hectare can be considered. The designer of a sediment containment system should consider the flow rate at which sediment laden runoff enters the system and ensure that sufficient geometry exists to permit adequate sedimentation to occur before the flow exits the system.

12.2 Containment Systems (Type I, II and III)

The type of containment system should be selected based on site specific conditions. The selection should generally be based on the following:

- Site erosion potential classification;
- Area of upstream soil exposure;
- Terrain conditions and space constraints; and
- Method of construction.

Construction of the containment system should be completed at high risk areas prior to any land disturbance and construction.

The selection of the location and type of sediment containment system should be based on the experience and judgement of the designer. The criteria for selection of the type of sediment containment systems are presented in Table 12.1.

Table 12.1: Containment System Types

| Containment System * | Site Erosion Potential Classification | Design Particle Size * | Affected Land Area * |
|--------------------------------|---------------------------------------|---|---|
| Type I (Sediment Basin) | High to Very High | Particle size ≤ 0.045 mm (medium silt and finer) | >2.0 ha |
| Type II (Sediment Trap) | Moderate | 0.045 mm < Particle size ≤ 0.014 mm (fine sand, coarse to medium silt) | <2.0 ha |
| Type III (Sediment Barrier) | Low to Very Low | Particle size >0.14 mm (medium to fine sand, coarse silt) | Grade break and velocity retarder for construction and intermediate areas |

*Source: Fifield, 2001

The three types of sediment containment systems are discussed in the following sections.

Type I (Sediment Basin)

Type I sediment containment system requires development of a structure to capture coarse to medium silt and a portion of smaller suspended particles. Since particles of this size have low settling velocities, large storage volumes, long flow-path lengths, and controlled discharges are required. As such, the containment basin will be configured accordingly to provide sufficient retention time and flow velocity reduction to permit sedimentation. Type I systems are designed to have the highest possible net efficiency and are best represented by the traditional sediment basin.

In general, sediment basins should be sized for a minimum recommended storage volume of 250 m³/ha where possible over the contributing disturbed bare soil area. Length (L) to width (W_e) ratio should be between 4:1 and 8:1. A practical width (W_e) can be 6 to 8 m. Generally, a practical pond depth is 1.2 m. The maximum pond depth should not exceed 1.5 m. An illustration of the Type I structure is presented in Figure 12.1.

Type II (Sediment Trap)

The Type II sediment containment system will capture suspended particles (fine sand to coarse silt) having higher settling velocities than particles requiring Type I structure. Consequently, small storage volumes and shorter flow-path lengths in comparison to widths can be used. As with a Type I structure, these sediment control systems will also have controlled discharges. Whereas their net effectiveness for the inflow and sedimentation of all suspended particles may be low, Type II systems will still have an effective sediment control measure.

In general, sediment traps should be sized for a recommended storage volume of 250 m³/ha over the contributing area, where possible; or a minimum storage volume of

150 m³/ha under conditions of land constraints. Length (L) to width (W_e) ratio should be between 2:1 to 3:1. A practical pond depth can be 1 m and the maximum pond depth should not exceed 1.5 m. Illustrations of Type II structures are presented in Figure 12.1 and Figure 12.2.

Type III (Sediment Barrier)

The least effective method to control suspended particles in runoff waters is represented by the Type III sediment containment systems. These are not necessarily design structures, as found with Type I and Type II systems, but are often BMPs (such as drainage ditch check structures). Whenever significant runoff occurs, all Type III systems have very low net and apparent effectiveness to control suspended particles. However, when runoff is low, the Type III sediment control systems can be effective in reducing flow velocity and suspended particles (coarse silt to fine sand) along gentle grade areas as long as they are regularly maintained.

12.3 Design Considerations

The design of a sedimentation pond can be a challenge as design parameters are difficult to define (e.g., storm events, runoff, soil erodibility and distribution of erodible soil). Thus, the evaluation of the effectiveness of pond performance is difficult to quantify. Therefore, the design of sediment pond or review of its performance should be undertaken by a qualified engineer with a practical perspective in experience and judgement. A suggested design rationale for the design of sediment containment systems is presented in Appendix G.

The focus of sediment control should be placed on capturing silt and larger sized soil particles. It is not practical to design for clay particles or colloidal organic particles due to the significant amount of time required for them to settle. Therefore, the emphasis for preventing release of water containing clay particles or colloidal organic particles from a construction site should be placed as erosion control.

Methods that estimate the efficiency of a given sediment containment system should be used with caution as there are several variables that affect the effectiveness of these systems. Estimating the efficiency of a sediment containment system should be used as a preliminary means of evaluating various options. However, the final selection should be based on the site conditions and the experience and judgement of the designer.

Care should be taken when designing embankments, since these may have to be designed according to dam design guidelines and regulatory requirements. Regardless of the height of an embankment, the consequences of failure will determine the level of effort during design and construction. A qualified engineer should design the foundation and embankment, and provide inspection during and after construction. Similarly, the optimization of pond areas and depth to obtain maximum efficiency should be undertaken by a qualified engineer.

12.4 Design Examples

A design example for a sediment pond is presented in Appendix H as Example H.16.

SECTION 12 - GUIDELINES FOR THE DESIGN OF SEDIMENT CONTAINMENT

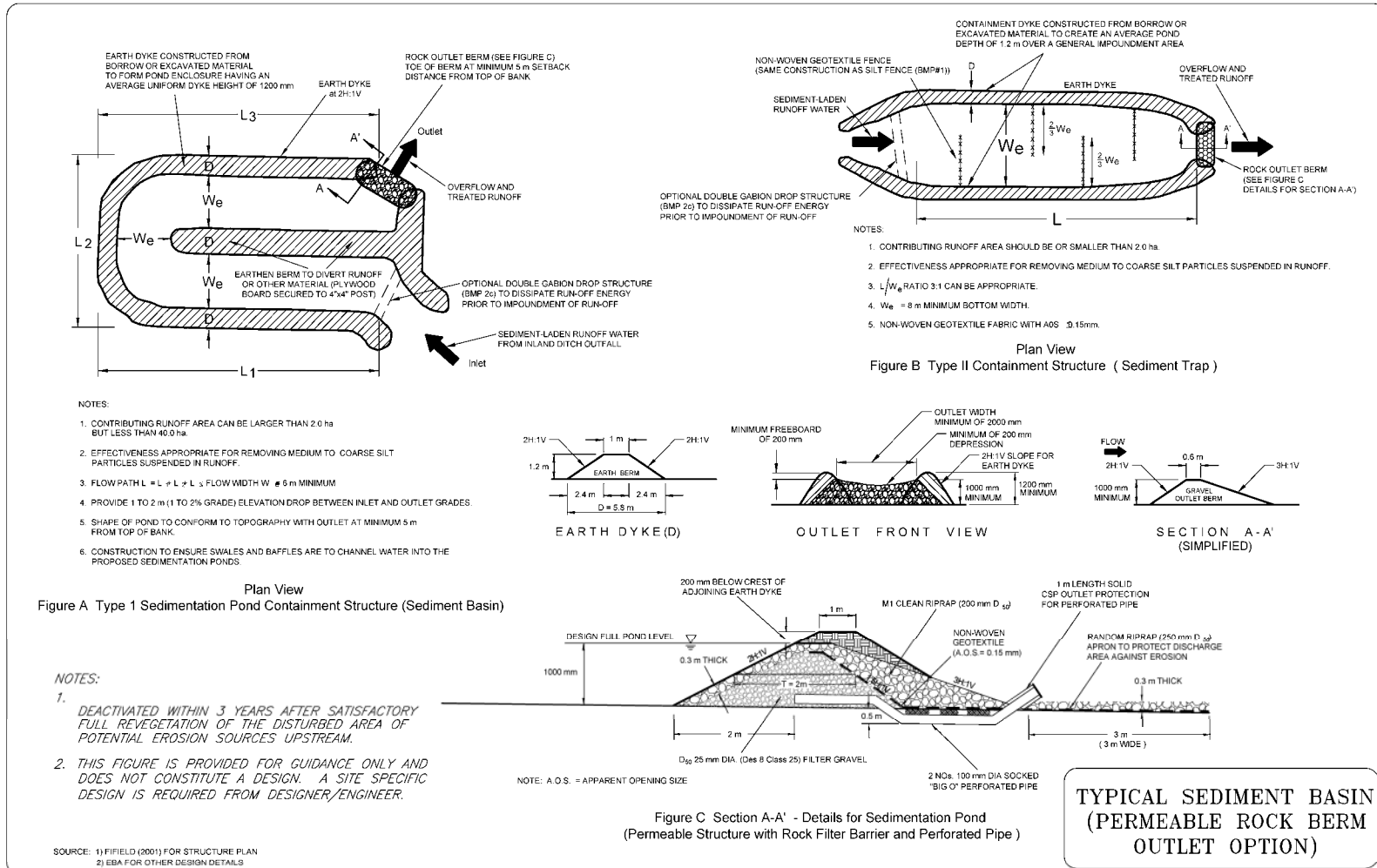

Figure 12.1: Type I and II Typical Sediment Containment Systems

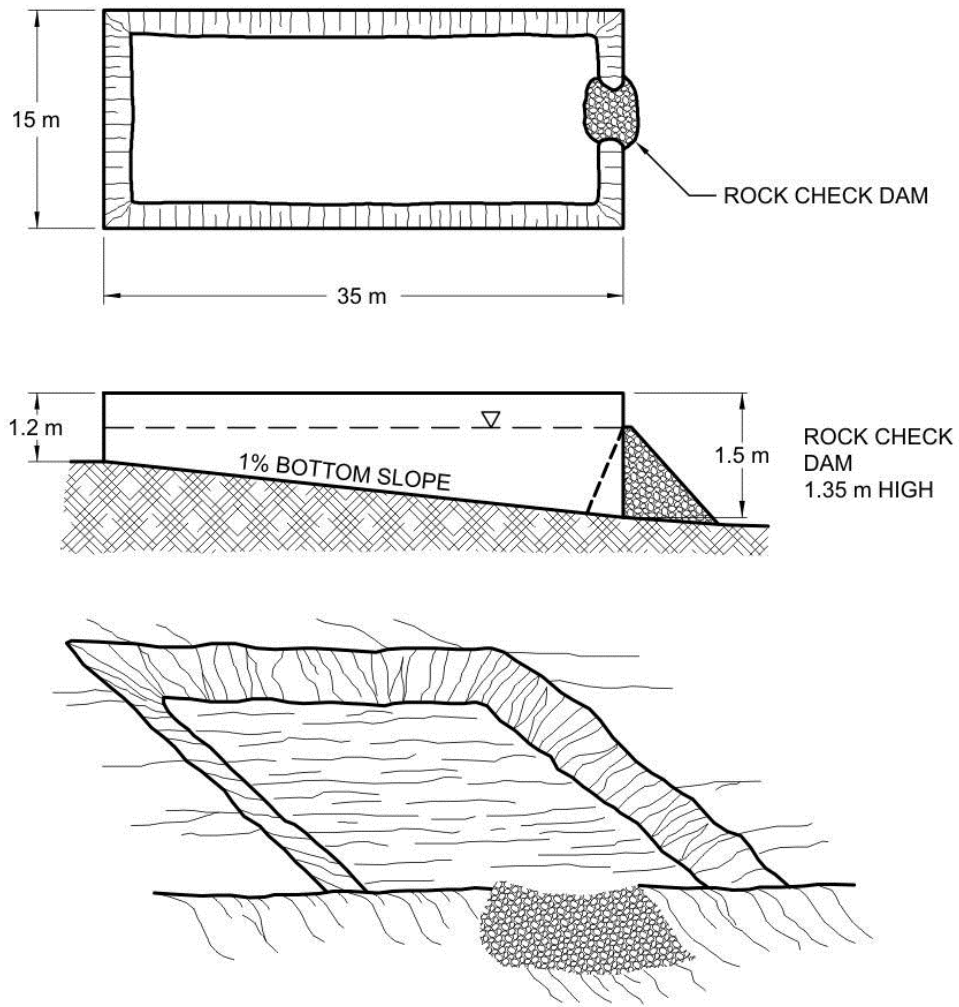

Figure 12.2: Type II Sediment Containment System (Sediment Trap) – Excavation Option

Source: City of Calgary, 2001

THIS PAGE LEFT BLANK INTENTIONALLY.

13.0 REFERENCES

- Alberta Transportation and Utilities, Technical Standards Branch. 1998. Erosion Control Reference Material (2001 updated draft), (AT EC Ref. Mat. Draft 2001).
- Alberta Transportation, 2002. Engineering Consultant Guidelines for Highway and Bridge Projects, Volume 1. Design and Tender.
- Alberta Transportation, 2007. Standard Specifications for Highway Construction.
- Alberta Transportation, 2009. Fish Habitat Manual: Guidelines & Procedures for Watercourse Crossings in Alberta.
- Alberta Transportation, 2010. Specifications for Bridge Construction.
- Alberta Transportation, et al. 2011. Environmental Construction Operations Plan (ECO Plan) Framework.
- Alberta Transportation, 2011. Environmental Management System Manual (Version 7.0).
- American Association of State Highways and Transportation Officials (AASHTO). 1991. Model Drainage Manual.
- Anderson, A.G., A.A. Painta, and J.T. Davenport, 1970. Tentative Design Procedure for Riprap Lined Channels. NCHRP Report No. 108, Highway Research Board, National Academy of Sciences, Washington, D.C., 1970.
- Ateshian, J.K.H., 1974. Estimation of rainfall erosion index. Proc. paper 10817, J.Irrig. and Drain. Div., AM. Soc. Civil Eng. 100(IR3):293-307.
- British Columbia Ministry of Forests. Water Restoration Program, Resources Tenures and Engineering Branch, 2001. Best Management Practices Handbook: Hillslope Restoration in British Columbia.
- Carpenter, T., 2000. "Silt Fence that Works".
- Chen, Y.H., and B.A. Cotton, 1988. Design of Roadside Channels with Flexible Linings. Hydraulic Engineering Circular No. 15(HEC-15), Federal Highway Administration, Publication No. FHWA-IP-87-7, USDOT/FHWA, McClean, Virginia.
- Chow, V.T. 1959. Open Channel Hydraulics, McGraw Hill Book Co.
- Chow, V.T. 1964. Handbook of Applied Hydrology, McGraw Hill Book Co.
- City of Calgary, 2001. Guidelines for Erosion and Sediment Control. www.gov.calgary.ab.ca/wwd
- Cox, R.L., R.C. Adams and T.B. Lawson, 1971. Erosion Control Study, Part II, Roadside Channels. Louisiana Department of Highways, in Cooperation with U.S. Department of Transportation, Federal Highway Administration.
- Engineering Handbook for Work Unit Staffs, U.S. Soil Conservation Services, Alexandria, La., 1956.
- Environment Canada. 1985. Rainfall Frequency Atlas for Canada.

-
- Environment Canada. 1996. CFA (Consolidated Frequency Analysis) Program (Version 3.1).
- Fifield, J.S., 2001. Designing for Effective Sediment and Erosion Control on Construction Sites. Forester Press, California.
- Galetovic, J.R., T.J. Toy, and G.R. Foster. 1998. Guidelines for the Use of the Revised Universal Soil Loss Equation (RUSLE), Version 1.06, on Mined Lands, Construction Sites, and Reclaimed Lands. Western Regional Coordination Center, Office of Surface Mining, Denver, CO.
- Goldman, S.J., Jackson, K., and Burgsztynsky, T.A. (1986), Erosion Sediment Control Handbook, McGraw Hill Inc.
- Harding, Mike, 2010. The Effect of Surface Roughness on Soil Erosion. Erosion Control Network.com (http://www.erosioncontrolnetwork.com/articles/articles_detail.aspx?n=108).
- Holtz and Kovacs, 1981. An Introduction to Geotechnical Engineering. Prentice Hall.
- Jiang, N., M.C. Hirschik, J.K. Mitchell, and R.A. Cook, 1998. Hydraulic and Sediment Trapping Performance of Rockfill. Proceedings of Conference XXIX, International Erosion Control Association (February 16-20).
- Kouwen, N., R.M. Li, and D.B. Simons, 1980. Velocity Measurements in a Channel Lined with Flexible Plastic Roughness Element. Technical Report No. CER79-80-RML-DBS-11, Department of Civil Engineering, Colorado State University, Fort Collins, Colorado.
- Madramootoo, C.A., 1988. Rainfall and runoff erosion indices for eastern Canada. Am. Soc. Agri. Eng. 31(1) 107-110.
- McCool, D.K., G.R. Foster, C.K. Mutchler and L.D. Meyer. 1989. Revised slope length factor for the Universal Soil Loss Equation. Trans. Am. Soc. Agric. Engrs. 32(5):1571-1576.
- McWhorter, J.C., T.G. Carpenter and R.N. Clark, 1968. Erosion Control Criteria for Drainage Channels. Conducted for Mississippi State Highway Department in Cooperation with U.S. Department of Transportation, Federal Highway Administration, by the Agricultural and Biological Engineering Department, Agricultural Experiment Station, Mississippi State University, State College, Mississippi.
- Nouh, M.A. and R.D. Townsend, 1979. Shear Stress Distribution in Stable Channel Bends. Journal of Hydraulics Division, ASCE, Vol. 105, No. HY10, Proc. Paper 14598, pp. 1233-1245.
- Ontario Ministry of Transportation (MOT), 1984. Drainage Manual. Chapter B: Design Flood estimates for Small Watersheds
- Portland Cement Association, 1964. Handbook of Concrete Culvert Hydraulics.
- Renard, K.G., 1997. Predicting Soil Erosion by Water: A Guide to Conservation Planning with the Revised Universal Soil Loss Equation (RUSLE). USDA Agricultural Handbook No. 703. US Department of Agriculture, Washington, D.C.

-
- RTAC Drainage Manual (Open Channel Design Procedures), 1987
- Salix Applied Earthcare, 2004. Erosion Control Standards and Construction Drawings for Computer-aided Drafting, Erosion Draw, Version 5.0
- Salix Applied Earthcare, 2005. Environmentally Sensitive Streambank Stabilization (E-SenSS) Software.
- Salix Applied Earthcare, 2004. BioDraw 3.0 Compendium of Biotechnical Soil Stabilization Solutions.
- Smerdon, E.T. and R.P. Beaseley, 1959. The Tractive Force Theory Applied to Stability of Open Channels in Cohesive Soils. Agricultural Experiment Station, Research Bulletin No. 715, University of Missouri, Columbia, Missouri.
- Smith, A.A. CEPL, A Civil Engineering Program Listing, McMaster University Bookstore, McMaster University, Hamilton, Ontario, 1974.
- Soil Conservation Service (SCS), 1986, Urban Hydrology for Small Watershed, Technical Release 55, US Department of Agriculture, June 1986.
- Soil Conservation Service, U.S. Department of Agriculture. Handbook of Channel Design for Soil and Water Conservation, 1954, prepared by the Stillwater Outdoor Hydraulic Laboratory in cooperation with the Oklahoma Agricultural Experiment Station, Publ. No. SCS-TP-61 March 1957, rev. June 1954.
- Thibodeau, K.G., 1982 to 1985. Performance of Temporary Ditch Linings. Interim Reports 1 to 17, Prepared for Federal Highway Administration by U.S. Geological Survey, Gulf Coast Hydroscience Center and Computer Science Corporation.
- Transportation Association of Canada (TAC), 2005. National Guide to Erosion and Sediment Control on Roadway Projects.
- U.S. Army Engineering Corps, 1979. HEC 2 Water Surface Profiles, Users' Manual, Corps of Engineers, Hydrologic Engineering Center, Davis, California.
- U.S. Department of Transportation. Federal Aviation Agency Circular Airport Drainage (AC150/5320-5A).
- Wall, G.J., D.R. Coote, E.A. Pringle and I.J. Shelton (editors). *RUSLEFAC 1997 – Revised Universal Soil Loss Equation for Application in Canada: A Handbook for Estimating Soil Loss from Water Erosion in Canada*. Research Branch, Agriculture and Agri-Food Canada. Ottawa. Contribution No. 02-92. 117pp.
- Wall, G.J., W.T. Dickinson and J. Greuel. 1983. Rainfall erosion indices for Canada east of the Rocky Mountains. *Can. J. Soil Sci.* 63:271-280.
- West, L.T., E.E. Alberts, et al., Soil Measurements: USDA – Water Erosion Prediction Project (WEPP), Winter Meeting of ASAE, Chicago (December 1987).
- Wigham, J.M. and W.J. Stolte. 1986. Rainfall and Runoff Factor for Erosion Estimates – Prairie Region. *Can. Agric. eng.* 28(2):71-75.
- Wischmeier, W.H., and D.D Smith, 1965. Predicting Rainfall Erosion Losses from Cropland East of the Rocky Mountains, Agriculture Handbook No. 282, U.S. Department of Agriculture, Washington, D.C.

REFERENCES

Wischmeier, W.H., and D.D Smith, 1978. Predicting Rainfall Erosion Losses – A Guide to Conservation Planning, Agriculture Handbook No. 537, U.S. Department of Agriculture, Science and Education Administration, Washington, D.C.

APPENDIX A

**EXAMPLE SOIL TEST DATA FOR
DIFFERENT PARTS OF ALBERTA
AND RESPECTIVE SOIL ERODIBILITY RATING
PRELIMINARY ASSESSMENT**

THIS PAGE LEFT BLANK INTENTIONALLY.

| <u>Table No.</u> | <u>Soils from the Area of:</u> |
|-------------------------|---------------------------------------|
| A.1 | Hotchkiss and Keg River |
| A.2 | Grimshaw and Notikewin |
| A.3 | Cherry Point and Hines Creek |
| A.4 | Sand River |
| A.5 | Waterton National Park |
| A.6 | Waterton National Park |

Table A.1: Test Data from Soil Samples in the Hotchkiss and Keg River Areas

| Material Type | Classification (USCS) | Liquid Limit (%) | Plastic Limit (%) | Plasticity Index (%) | Composition | | |
|---------------|-----------------------|------------------|-------------------|----------------------|----------------------|------------------------|--------------------|
| | | | | | Sand (2.0-0.05) (mm) | Silt (0.05-0.002) (mm) | Clay (<0.002) (mm) |
| Lacustrine | CH | 56 | 25 | 31 | 5 | 26 | 69 |
| | CH | 51 | 21 | 30 | 2 | 45 | 53 |
| | CI | 45 | 20 | 25 | 13 | 44 | 43 |
| | CH | 61 | 21 | 40 | 10 | 29 | 61 |
| | CH | 60 | 21 | 39 | 5 | 43 | 52 |
| | CH | 84 | 36 | 48 | 0 | 21 | 79 |
| Fluvial | CH | 52 | 24 | 28 | 8 | 57 | 43 |
| Residual | SM | | | TR | 78 | 10 | 12 |
| | MH | 51 | 30 | 21 | 1 | 45 | 54 |

Table A.2: Test Data from Soil Samples in Grimshaw and Notikewin Areas

| Material Type | Classification (USCS) | Liquid Limit (%) | Plastic Limit (%) | Plasticity Index (%) | Composition | | |
|---------------|-----------------------|------------------|-------------------|----------------------|----------------------|------------------------|--------------------|
| | | | | | Sand (2.0-0.05) (mm) | Silt (0.05-0.002) (mm) | Clay (<0.002) (mm) |
| Till | CI | 43 | 20 | 23 | 18 | 39 | 43 |
| | CI | 41 | 19 | 22 | 19 | 41 | 40 |
| | CI | 36 | 18 | 18 | 27 | 33 | 40 |
| | CI | 43 | 18 | 25 | 22 | 42 | 36 |
| | CI | 41 | 20 | 21 | 21 | 48 | 38 |
| | CI | 44 | 20 | 24 | 20 | 37 | 43 |
| | CI | 44 | 18 | 26 | 25 | 34 | 41 |
| | CI | 43 | 19 | 24 | 21 | 41 | 38 |
| | CI | 37 | 18 | 19 | 23 | 35 | 32 |
| Lacustrine | CI | 40 | 18 | 22 | 20 | 46 | 34 |
| | CH | 58 | 24 | 34 | 3 | 19 | 78 |
| | CI | 44 | 18 | 26 | 0 | 25 | 75 |
| | CH | 61 | 28 | 33 | 2 | 40 | 58 |
| | CH | 57 | 24 | 33 | 2 | 44 | 56 |
| | CH | 66 | 27 | 39 | 0 | 40 | 60 |
| | CH | 64 | 28 | 36 | 3 | 19 | 78 |
| | CH | 69 | 26 | 43 | 6 | 20 | 74 |
| | CI-CH | 50 | 21 | 29 | 3 | 35 | 62 |
| | CI | 43 | 20 | 23 | 7 | 44 | 49 |
| Fluvial | CI | 42 | 21 | 21 | 22 | 45 | 33 |
| | CI | 38 | 19 | 19 | 20 | 50 | 30 |

Table A.3: Test Data from Soil Samples in Cherry Point and Hines Creek Area

| Material Type | Classification (USCS) | Liquid Limit (%) | Plastic Limit (%) | Plasticity Index (%) | Composition | | |
|---------------|-----------------------|------------------|-------------------|----------------------|----------------------|------------------------|--------------------|
| | | | | | Sand (2.0-0.05) (mm) | Silt (0.05-0.002) (mm) | Clay (<0.002) (mm) |
| Till | CI | 39 | 18 | 21 | 20 | 38 | 42 |
| | CH | 51 | 23 | 28 | 12 | 33 | 55 |
| | CI | 43 | 20 | 23 | 20 | 42 | 38 |
| | CI | 41 | 20 | 21 | 17 | 49 | 34 |
| | CI | 40 | 19 | 21 | 15 | 41 | 44 |
| | CH | 67 | 30 | 37 | 2 | 15 | 83 |
| | MH | 78 | 38 | 40 | 5 | 9 | 86 |
| | CH | 55 | 25 | 30 | 1 | 41 | 58 |
| | CI | 45 | 26 | 19 | 6 | 60 | 34 |
| Lacustrine | CH | 55 | 24 | 31 | 10 | 23 | 67 |
| | CH | 69 | 30 | 39 | 1 | 19 | 80 |
| | CH | 51 | 21 | 30 | 17 | 40 | 43 |
| | CH | 69 | 28 | 41 | 3 | 27 | 70 |
| Fluvial | CI | 43 | 23 | 20 | 15 | 32 | 53 |
| | CI | 41 | 19 | 22 | 21 | 43 | 36 |
| | CI | 39 | 19 | 20 | 29 | 38 | 33 |
| | CI | 41 | 22 | 19 | 16 | 51 | 33 |
| | CI | 33 | 21 | 12 | 2 | 32 | 65 |
| | CI | 35 | 23 | 12 | 32 | 49 | 19 |
| | ML | 32 | 23 | 9 | 59 | 25 | 16 |
| | CL-MI | 22 | 17 | 5 | 84 | 14 | 2 |
| | MH | 51 | 30 | 21 | 8 | 19 | 73 |
| | MH | 41 | 27 | 14 | 8 | 42 | 50 |

Note: Potential soil erodibility: moderate to high

Table A.4: Test Data from Soil Samples in Sand River Area

| Material Type | Classification (USCS) | Liquid Limit (%) | Plastic Limit (%) | Plasticity Index (%) | Composition | | | |
|---------------|-----------------------|------------------|-------------------|----------------------|------------------|----------------------|------------------------|--------------------|
| | | | | | Gravel (>2) (mm) | Sand (2.0-0.05) (mm) | Silt (0.05-0.002) (mm) | Clay (<0.002) (mm) |
| Till | CI-CH | 49 | 26 | 23 | | 22 | 35 | 43 |
| | CI | 35 | 20 | 15 | 1 | 29 | 32 | 38 |
| | CI | 36 | 21 | 15 | 3 | 38 | 27 | 37 |
| | CI | 31 | 17 | 14 | 2 | 34 | 27 | 37 |
| | CI | 32 | 19 | 13 | 1 | 30 | 34 | 35 |
| | CI | 38 | 19 | 19 | 1 | 31 | 33 | 35 |
| | CL | 27 | 15 | 12 | 1 | 38 | 29 | 32 |
| | CL-CI | 30 | 15 | 15 | 10 | 30 | 30 | 30 |
| | CI | 33 | 17 | 16 | 1 | 30 | 39 | 30 |
| | CI | 33 | 17 | 16 | 2 | 40 | 28 | 30 |
| | CL-CI | 28 | 15 | 13 | 3 | 40 | 27 | 30 |
| | CI | 27 | 14 | 13 | 1 | 42 | 28 | 29 |
| | CI | 31 | 17 | 14 | | | 34 | 28 |
| | CL-CI | 29 | 16 | 13 | 18 | 20 | 34 | 28 |
| | CL-CI | 31 | 18 | 13 | 18 | 20 | 34 | 28 |
| | CL | 24 | 16 | 8 | 1 | 40 | 31 | 28 |
| | CI | 32 | 17 | 15 | 2 | 30 | 42 | 26 |
| | CL-CI | 29 | 16 | 13 | 2 | 41 | 31 | 26 |
| | CL | 27 | 15 | 12 | 2 | 42 | 30 | 26 |
| | ML | 19 | 16 | 3 | 7 | 37 | 30 | 26 |
| | CL | 23 | 14 | 9 | 1 | 47 | 27 | 25 |
| | CL | 29 | 13 | 16 | 5 | 45 | 25 | 25 |
| | CL | 27 | 16 | 11 | | | 37 | 25 |
| CL | 28 | 17 | 11 | 3 | 39 | 34 | 24 | |
| CL-CI | 30 | 16 | 14 | 2 | 46 | 28 | 24 | |
| CL | 24 | 14 | 10 | 3 | 47 | 26 | 24 | |
| CL | 24 | 14 | 10 | 2 | 52 | | | |
| SM | | | | NP | 4 | 53 | 29 | 14 |
| Lacustrine | CH-CL | 51 | 24 | 27 | | 2 | 46 | 52 |



Note:  Potential soil erodibility: moderate to high

Table A.5: Test Data from Soil Samples in Waterton National Park Area

| Material Type | Classification (USCS) | Liquid Limit (%) | Plastic Limit (%) | Plasticity Index (%) | Composition | | |
|------------------|-----------------------|------------------|-------------------|----------------------|----------------------|------------------------|--------------------|
| | | | | | Sand (2.0-0.05) (mm) | Silt (0.05-0.002) (mm) | Clay (<0.002) (mm) |
| Till | CL-ML | 27 | 21 | 6 | 49 | 28 | 23 |
| | CI | 30 | 18 | 12 | 18 | 61 | 21 |
| | CI | 37 | 23 | 14 | 18 | 34 | 31 |
| | CI | 38 | 23 | 15 | 35 | 3 | 32 |
| Lacustrine | CI | 39 | 24 | 15 | 36 | 32 | 32 |
| | MH | 72 | 39 | 33 | 1 | 39 | 67 |
| | MH | 68 | 39 | 29 | 1 | 39 | 60 |
| Fluvial ----- | SM | | | NP | 88 | 6 | 6 |
| | SP-SM | | | NP | 88 | 10 | 2 |
| Acadian | SM | | | NP | 58 | 23 | 19 |
| | SW | | | NP | 96 | 4 | 0 |
| | SM | | | NP | 87 | 6 | 7 |

Note:  Potential soil erodibility: moderate to high

APPENDIX A

Table A.6: Test Data from Soil Samples in Waterton National Park Area

| Material Type | Classification (USCS) | Liquid Limit (%) | Plastic Limit (%) | Plasticity Index (%) | Composition | | | |
|---------------|-----------------------|------------------|-------------------|----------------------|------------------|----------------------|------------------------|--------------------|
| | | | | | Gravel (>2) (mm) | Sand (2.0-0.05) (mm) | Silt (0.05-0.002) (mm) | Clay (<0.002) (mm) |
| Till | CH | 50 | 22 | 28 | 18 | 12 | 38 | 32 |
| | CL-ML | 27 | 21 | 6 | 38 | 26 | 27 | 9 |
| | GM | 17 | 15 | 2 | 43 | 23 | 27 | 7 |
| | GM-GC | 25 | 20 | 5 | 55 | 22 | 19 | 4 |
| | ML | 19 | 15 | 4 | 3 | 41 | 46 | 10 |
| | GC | 47 | 37 | 10 | 77 | 6 | 9 | 8 |
| | GM | | | NP | 60 | 26 | 9 | 5 |
| | SC | 36 | 18 | 18 | 35 | 27 | 27 | 11 |
| | CI | 37 | 20 | 17 | 5 | 8 | 72 | 15 |
| | GM | 18 | 16 | 2 | 48 | 39 | 10 | 3 |
| Fluvial | GP-GM | | | NP | 76 | 18 | 4 | 2 |
| | ML | | | NP | | 28 | 70 | 2 |
| | GP-GM | | | NP | 59 | 33 | 5 | 3 |
| | MH | 53 | 30 | 23 | | 3 | 67 | 30 |
| | ML | 35 | 25 | 10 | | 7 | 71 | 22 |
| | ML-CL | 42 | 27 | 15 | | 15 | 58 | 27 |
| | GC | 22 | 14 | 8 | 76 | 7 | 9 | 8 |
| | GD | | | NP | 84 | 12 | 3 | 1 |
| | GM | 28 | 22 | 6 | 83 | 5 | 7 | 5 |
| | SM | | | NP | 43 | 45 | 10 | 7 |
| | SM | 27 | 22 | 5 | 55 | 33 | 8 | 4 |
| | ML | 37 | 28 | 9 | 2 | 25 | 54 | 19 |
| | GP-GM | | | NP | 78 | 14 | 6 | 2 |
| | GP-GM | | | NP | 79 | 14 | 5 | 2 |
| | GP-GM | 16 | 14 | 2 | 78 | 15 | 5 | 2 |
| | GM | | | NP | 58 | 25 | 13 | 4 |
| | ML | 36 | 19 | 17 | 4 | 29 | 50 | 17 |
| | ML | 26 | 23 | 3 | 7 | 44 | 38 | 11 |
| | SM | | | NP | | 75 | 22 | 3 |
| | SM | | | NP | | 64 | 27 | 11 |
| | SM-SC | 25 | 19 | 6 | 42 | 40 | 13 | 5 |
| | GM-GC | 25 | 20 | 5 | 74 | 17 | 7 | 4 |
| | GC | 43 | 20 | 23 | 55 | 13 | 20 | 12 |
| | GM | 19 | 16 | 3 | 78 | 8 | 10 | 4 |
| | SM | 21 | 19 | 2 | 40 | 46 | 10 | 4 |
| | GP-GC | 25 | 10 | 15 | 80 | 11 | 6 | 3 |
| | GM | | | NP | 71 | 18 | 9 | 2 |

Note: Potential soil erodibility: moderate to high

APPENDIX B

SUPPORTING INFORMATION FOR RUSLE

THIS PAGE LEFT BLANK INTENTIONALLY.

Supporting Information for RUSLE

| | |
|------------|---|
| Figure B-1 | Isoerodent map showing R_t values for the Prairie Region (whole year) |
| Figure B-2 | Isoerodent map showing R values for the Prairie Region (spring to fall) |
| Figure B-3 | Adjustment for winter conditions. R_s for the Prairie Region (winter) |
| Figure B-4 | Monthly Distribution Patterns of R_t for Selected Stations in Alberta |
| Figure B-5 | The soil erodibility nomograph (Foster et al, 1981) |
| Figure B-6 | Structure code based on textural classification |
| Figure B-7 | Permeability code based on textural classification |
| | |
| Table B-1 | Erosivity index and monthly distribution for sites in the Prairie Region and Eastern Canada |
| Table B-2 | Soil erodibility values (K) for common surface textures |
| Table B-3 | Values for topographic factor (LS), for low ratio of rill:interill erosion |
| Table B-4 | Slope Length exponents (m) for range of slopes and rill:interill erosion classes |
| Table B-5 | Soil loss factors (SLF) for irregular slopes |
| Table B-6a | C Factors for mulch placement and respective slope length limits |
| Table B-6b | C Factors for other treatments |
| Table B-7 | P-Factor values for construction site |

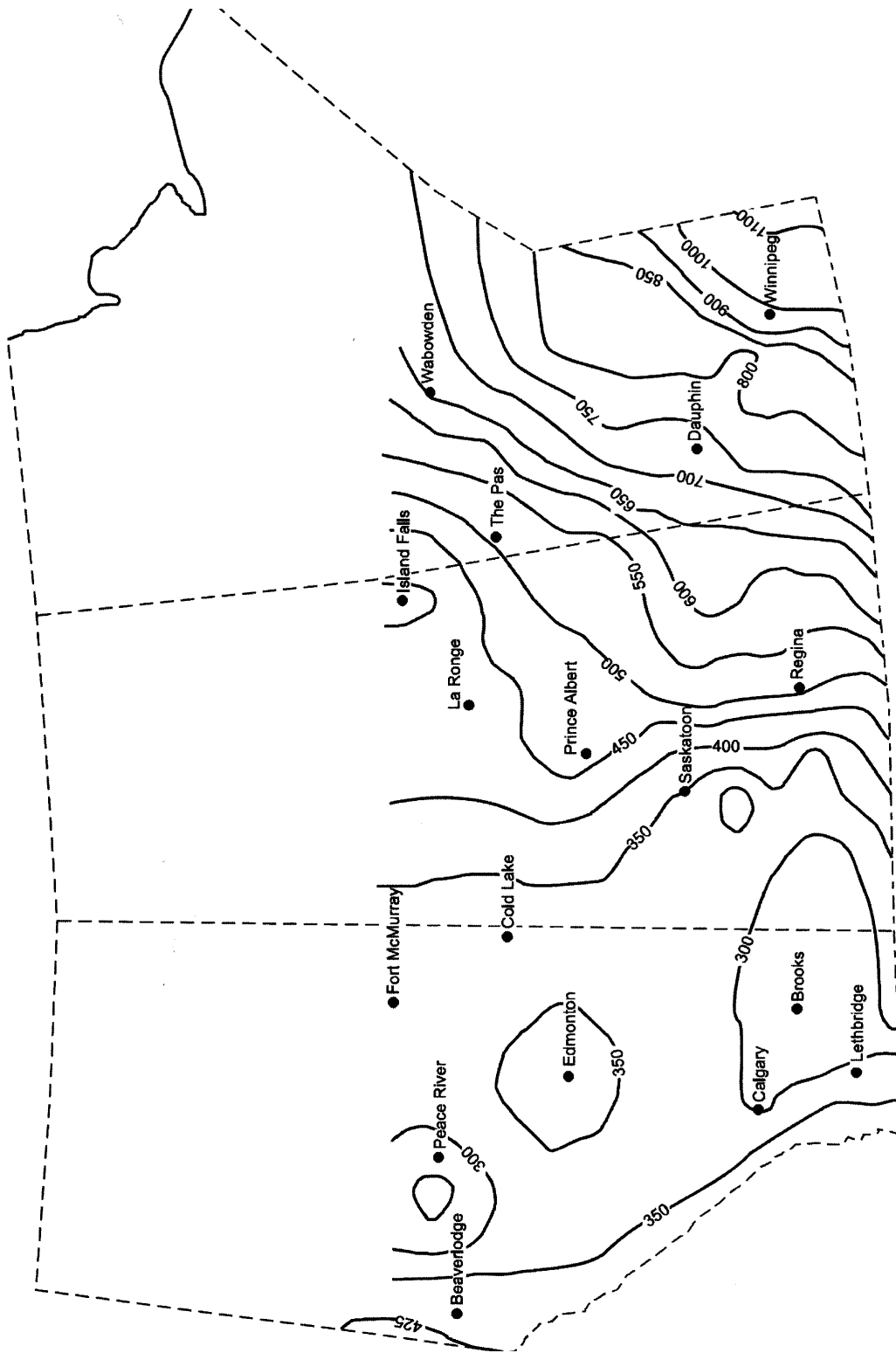

Figure B-1: Isoerodent map showing R_t values for the Prairie Region (whole year)

(Source: Wall et al, 1997)

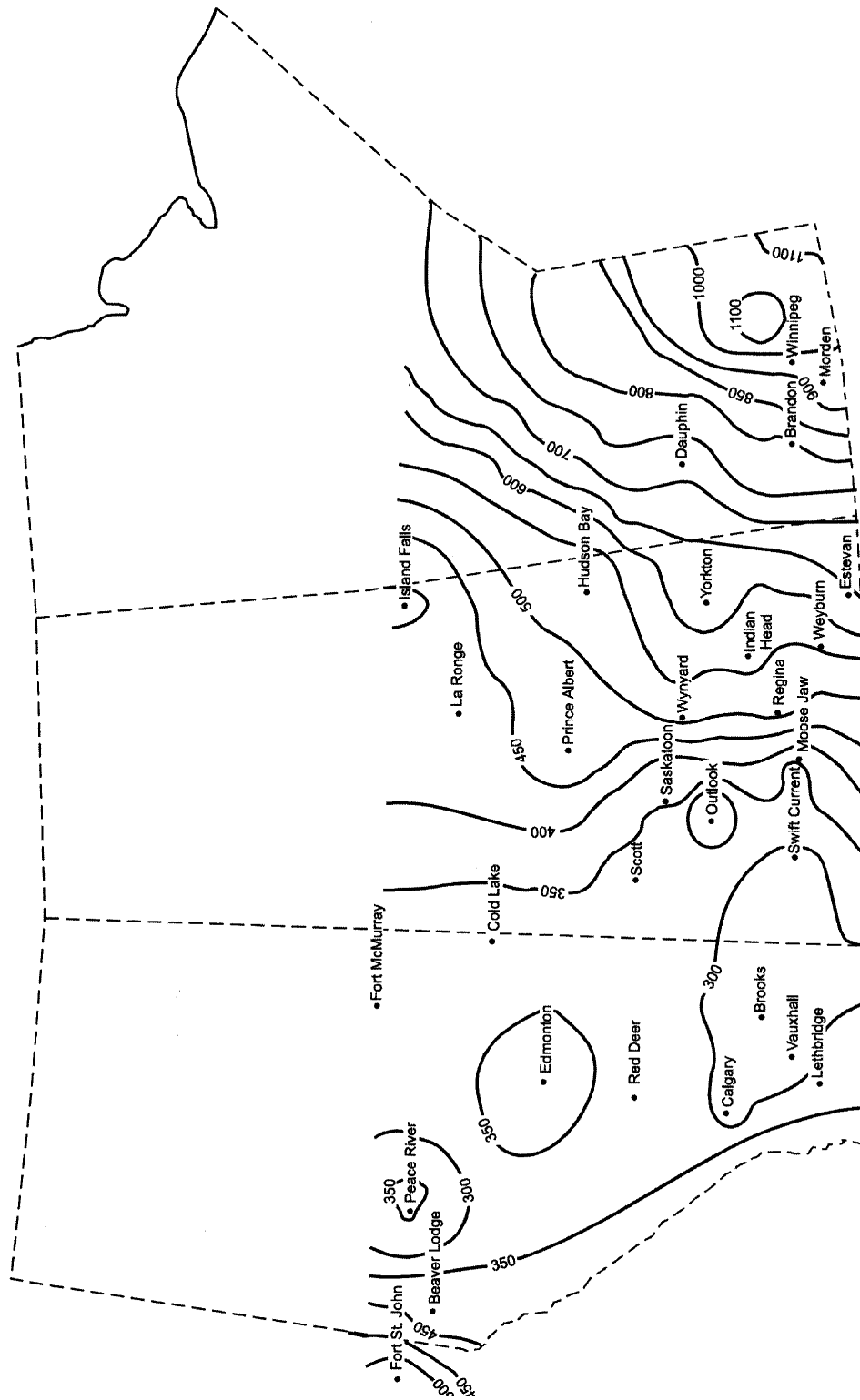

Figure B-2: Isoerodent map showing R values for the Prairie Region (spring to fall)

(Source: Wall et al, 1997)

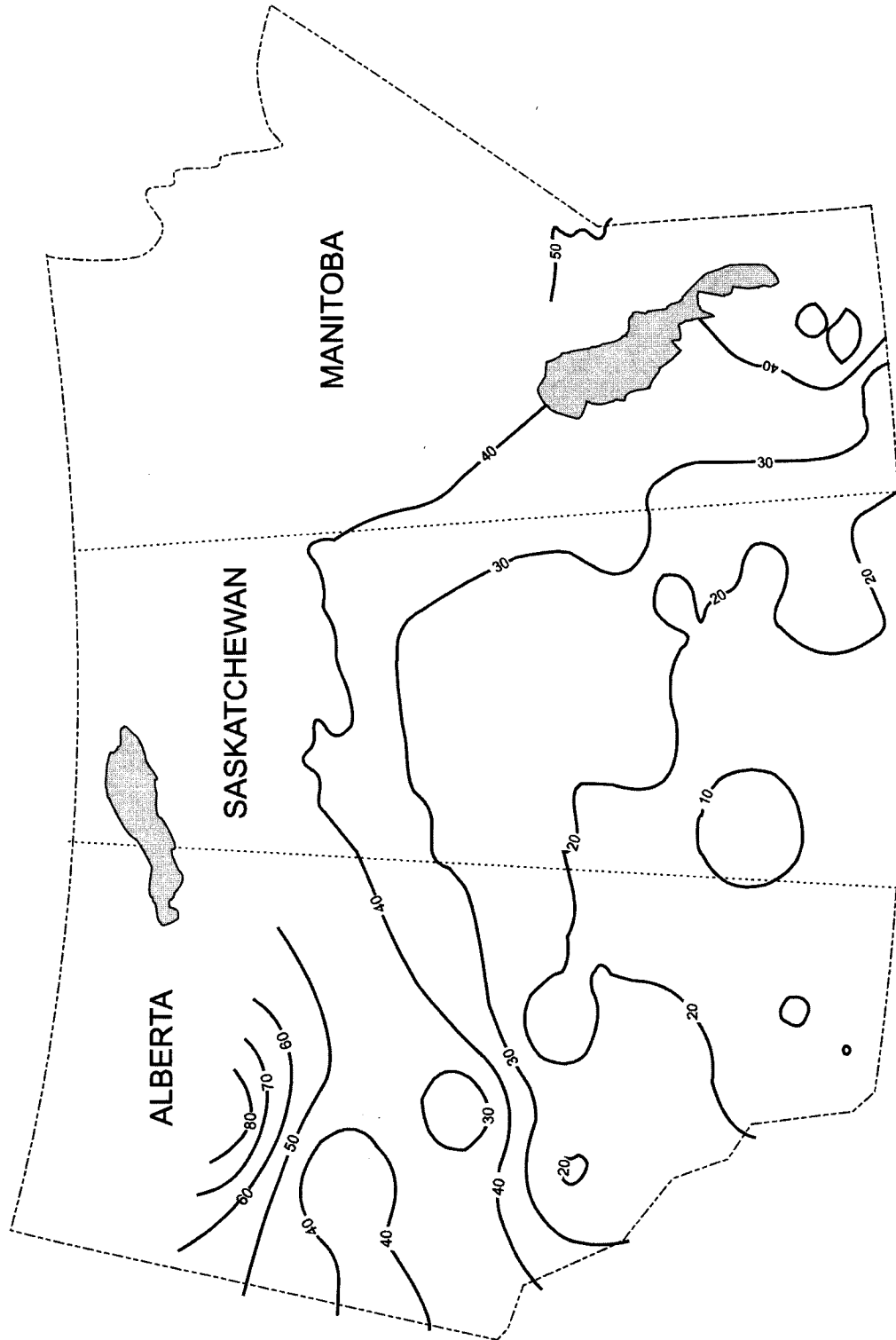

Figure B-3: Adjustment for winter conditions. R_s for the Prairie Region (winter)

(Source: Wall et al, 1997)

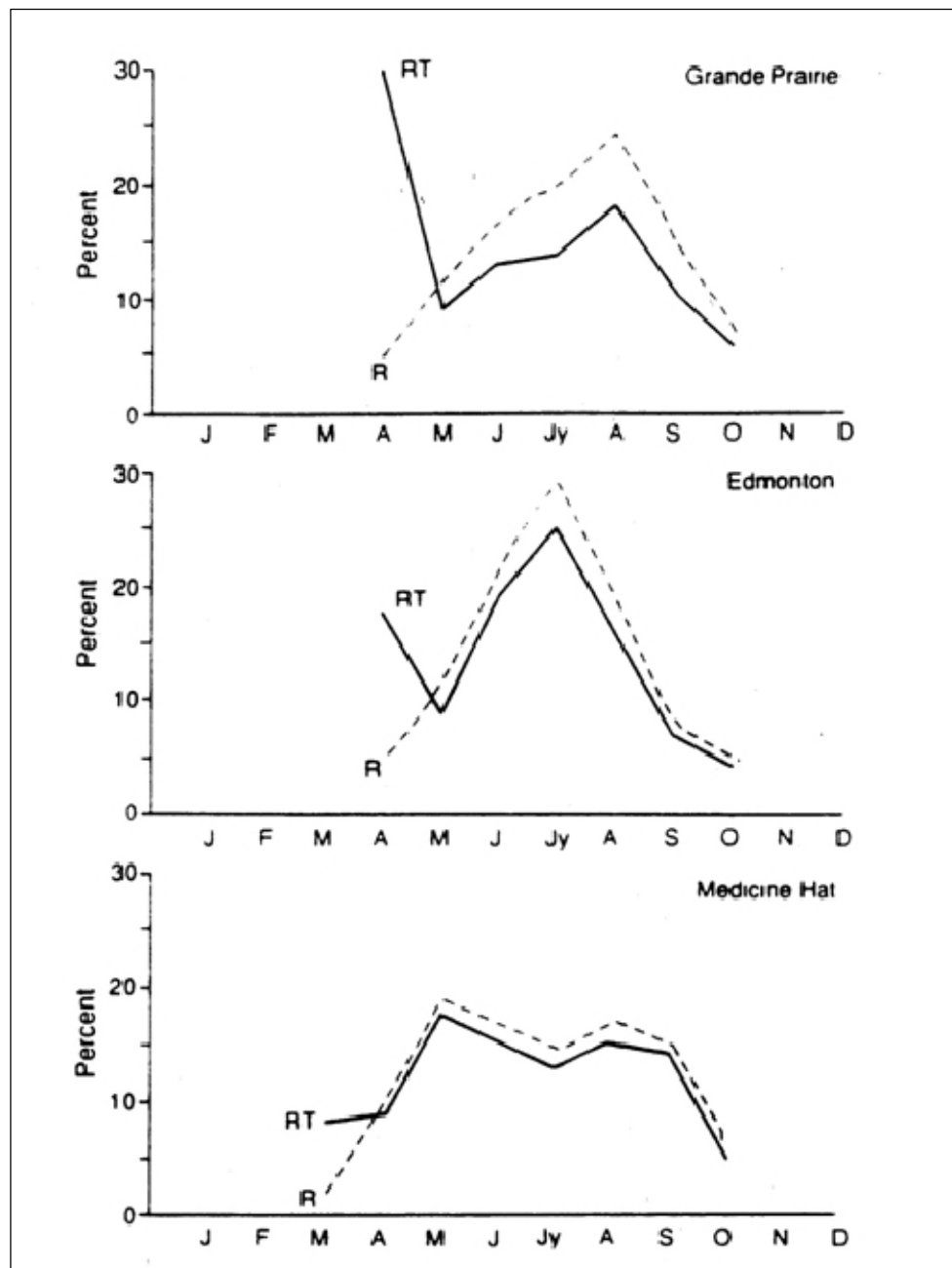

Figure B-4: Monthly Distribution Patterns of R_t for Selected Stations in Alberta
 From: Water Erosion Potential of Soils in Alberta (1985). Agriculture Canada

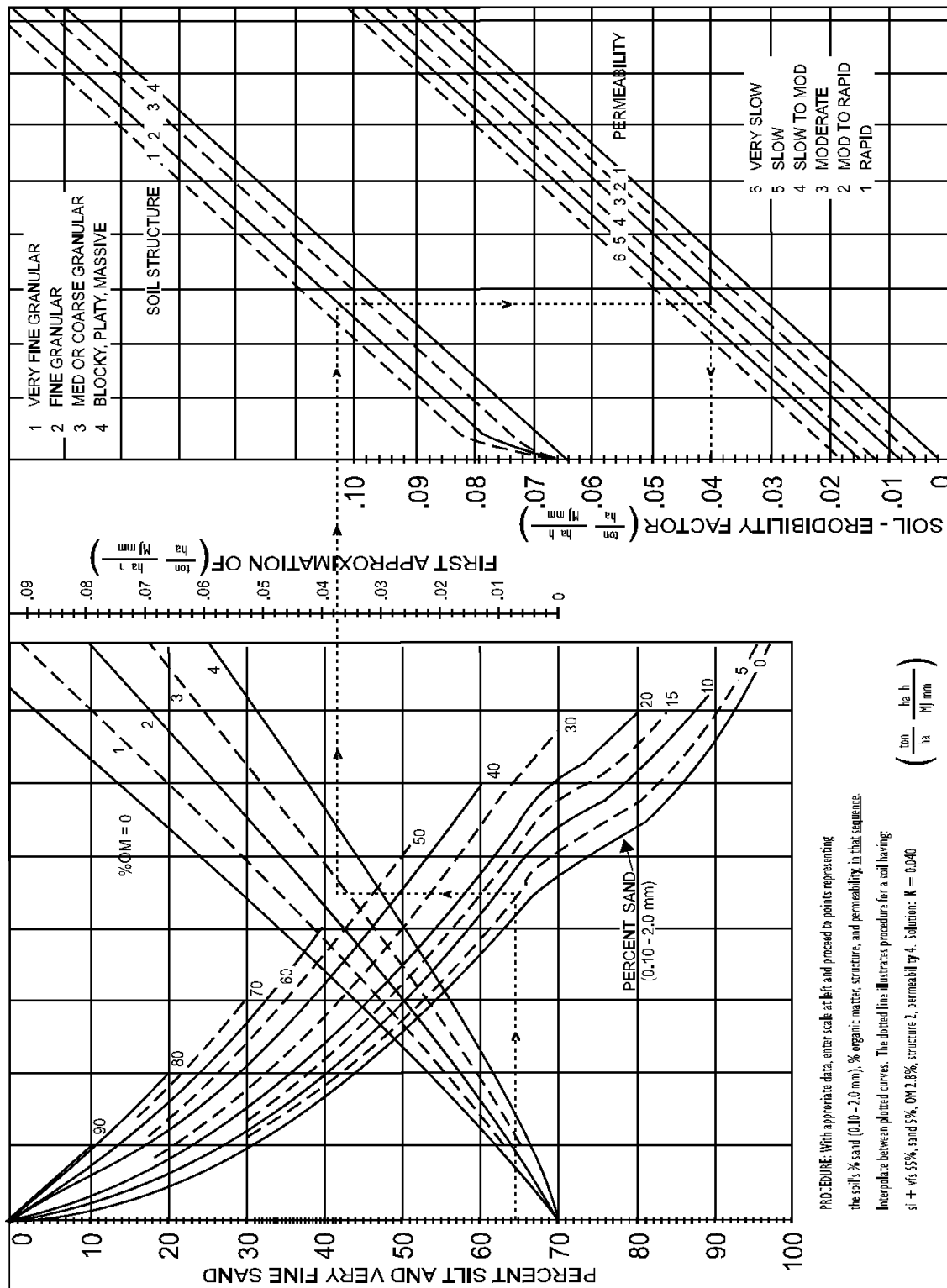

Figure B-5: The soil erodibility nomograph (Foster et al, 1981)

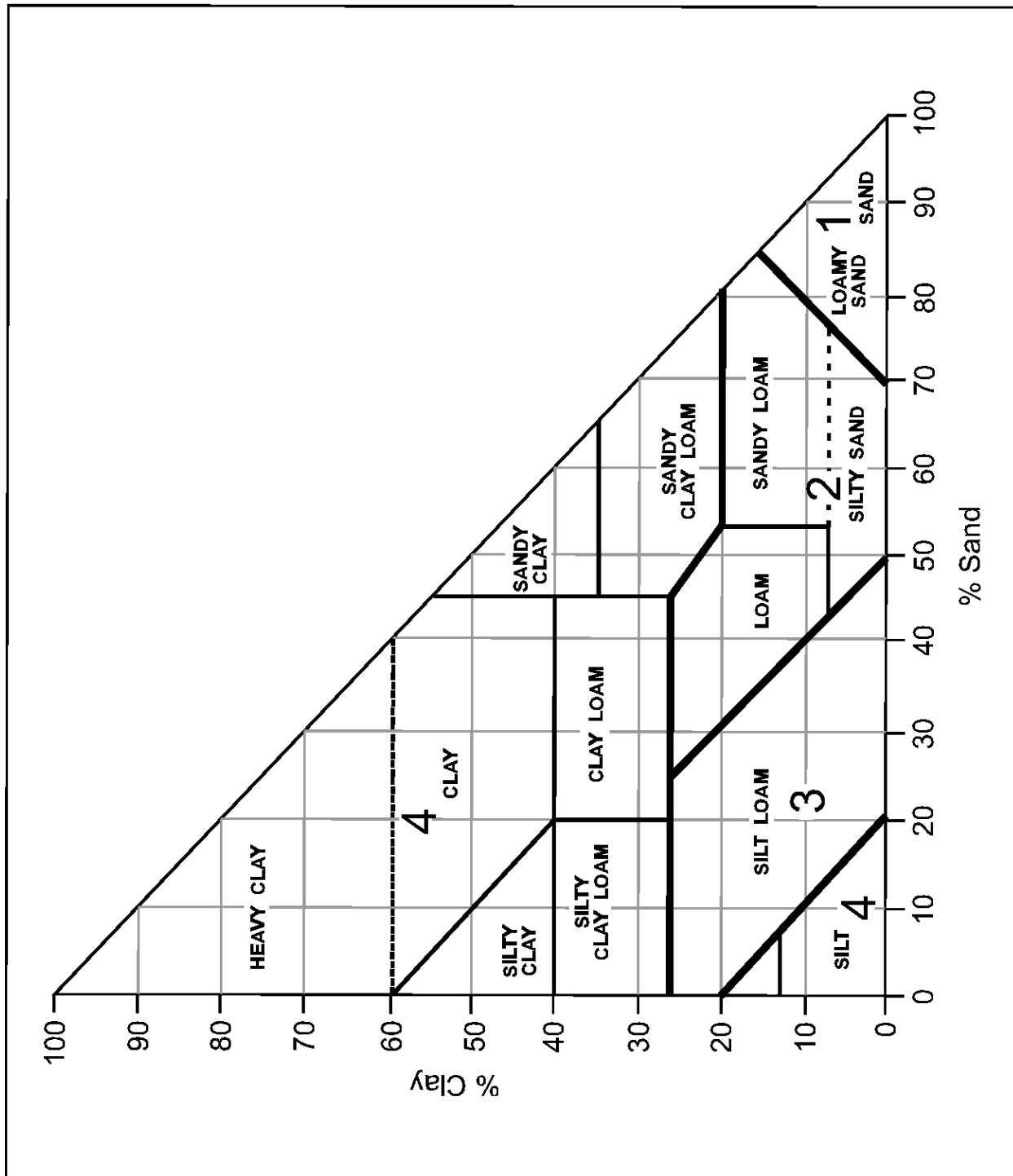

Figure B-6: Structure code based on textural classification

Source: 1) Ontario Centre for Soil Resource Evaluation, 1993
 2) Wall et al, 1997

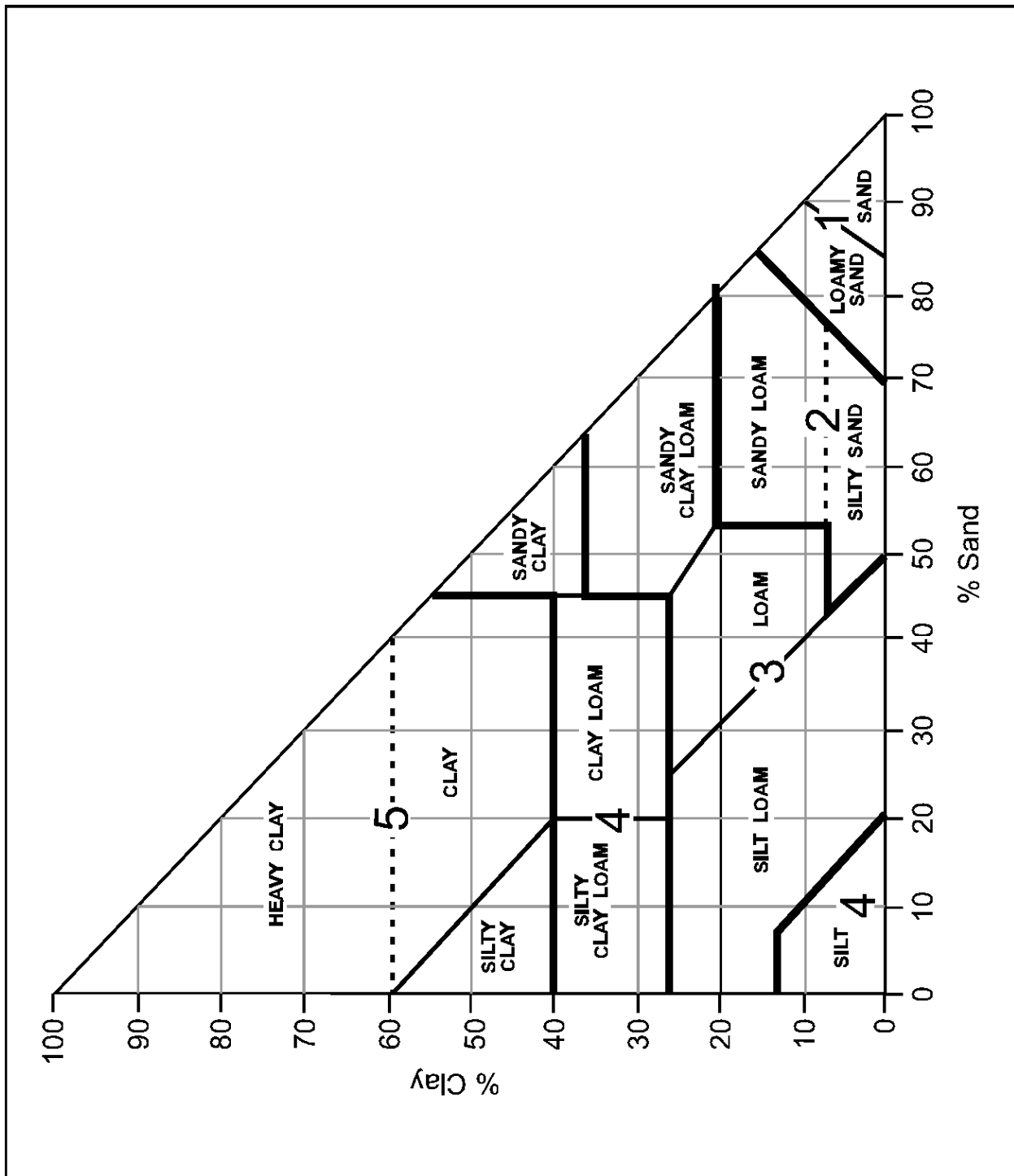

Figure B-7: Permeability code based on textural classification

(Source: Ontario Centre for Soil Resource Evaluation, 1993)

| Site | R _t | Monthly percentage of erosivity index (R) | | | | | | | | | | | |
|-----------------------|----------------|---|---|---|----|----|----|----|----|----|----|----|----|
| | | J | F | M | A | M | J | J | A | S | O | N | D |
| Beaverlodge, B.C. | 378 | 0 | 0 | 4 | 9 | 3 | 20 | 23 | 34 | 7 | 0 | 0 | 0 |
| Lethbridge, Alta. | 346 | 0 | 0 | 1 | 4 | 11 | 22 | 37 | 16 | 10 | 0 | 0 | 0 |
| Peace River, Alta. | 226 | 0 | 0 | 4 | 10 | 5 | 17 | 41 | 17 | 7 | 1 | 0 | 0 |
| Vauxhall, Alta. | 270 | 0 | 0 | 2 | 13 | 9 | 24 | 24 | 16 | 11 | 0 | 0 | 0 |
| Broadview, Sask. | 342 | 0 | 0 | 2 | 7 | 8 | 12 | 24 | 31 | 15 | 2 | 0 | 0 |
| Estevan, Sask. | 680 | 0 | 0 | 1 | 2 | 8 | 22 | 41 | 18 | 9 | 1 | 0 | 0 |
| Outlook, Sask. | 261 | 0 | 0 | 1 | 4 | 8 | 39 | 32 | 12 | 5 | 0 | 0 | 0 |
| Saskatoon, Sask. | 348 | 0 | 0 | 2 | 6 | 13 | 38 | 33 | 5 | 3 | 0 | 0 | 0 |
| Swift Current, Sask. | 268 | 0 | 0 | 1 | 3 | 7 | 43 | 25 | 16 | 5 | 0 | 0 | 0 |
| Wynyard, Sask. | 572 | 0 | 0 | 1 | 2 | 13 | 18 | 39 | 22 | 4 | 1 | 0 | 0 |
| Yorkton, Sask. | 663 | 0 | 0 | 1 | 2 | 7 | 23 | 26 | 28 | 10 | 2 | 0 | 0 |
| Hudson Bay | 510 | 0 | 0 | 2 | 5 | 5 | 22 | 37 | 18 | 10 | 1 | 0 | 0 |
| Glenlea | 1029 | 0 | 0 | 2 | 5 | 11 | 23 | 31 | 20 | 6 | 3 | 0 | 0 |
| Gimli, Man. | 848 | 0 | 0 | 1 | 4 | 6 | 25 | 24 | 27 | 11 | 3 | 0 | 0 |
| Winnipeg, Man. | 1093 | 0 | 0 | 1 | 3 | 12 | 18 | 21 | 32 | 12 | 2 | 0 | 0 |
| White River, Ont. | 1075 | 0 | 0 | 0 | 2 | 8 | 16 | 17 | 26 | 23 | 5 | 3 | 0 |
| Windsor, Ont. | 1615 | 2 | 3 | 5 | 9 | 6 | 15 | 20 | 18 | 9 | 5 | 4 | 4 |
| London, Ont. | 1330 | 3 | 3 | 3 | 9 | 7 | 14 | 18 | 15 | 11 | 7 | 6 | 4 |
| Montreal, Que. | 920 | 0 | 0 | 0 | 6 | 5 | 17 | 19 | 22 | 15 | 9 | 7 | 0 |
| Moncton, N.B. | 1225 | 3 | 4 | 4 | 4 | 8 | 10 | 14 | 15 | 10 | 12 | 11 | 5 |
| Halifax, N.S. | 1790 | * | * | * | 2 | 11 | 16 | 19 | 24 | 19 | 8 | 1 | 0 |
| Kentville, N.S. | 1975 | 4 | 6 | 7 | 6 | 3 | 12 | 12 | 15 | 10 | 10 | 7 | 8 |
| Nappan, N.S. | 1900 | 3 | 3 | 3 | 9 | 7 | 14 | 18 | 15 | 11 | 7 | 6 | 4 |
| Truro, N.S. | 2000 | 4 | 8 | 5 | 5 | 5 | 7 | 6 | 13 | 11 | 11 | 15 | 10 |
| Charlottetown, P.E.I. | 1520 | 4 | 4 | 4 | 9 | 7 | 13 | 17 | 14 | 11 | 7 | 5 | 5 |
| St. John's, Nfld. | 1700 | 4 | 8 | 5 | 5 | 5 | 7 | 6 | 13 | 11 | 11 | 17 | 8 |

* Data not available
Units for R = MJ mm ha⁻¹ h⁻¹

Table B-1: Erosivity index and monthly distribution for sites in the Prairie Region and Eastern Canada

(Source RUSLEFAC)

| TEXTURAL CLASS | ORGANIC MATTER CONTENT | | |
|----------------------|------------------------|-------|---------|
| | < 2 % | > 2 % | AVERAGE |
| Clay | 0.032 | 0.028 | 0.029 |
| Clay Loam | 0.044 | 0.037 | 0.040 |
| Coarse Sandy Loam | - | 0.009 | 0.009 |
| Fine Sand | 0.012 | 0.008 | 0.011 |
| Fine Sandy Loam | 0.029 | 0.022 | 0.024 |
| Heavy Clay | 0.025 | 0.020 | 0.022 |
| Loam | 0.045 | 0.038 | 0.040 |
| Loamy Fine Sand | 0.020 | 0.012 | 0.015 |
| Loamy Sand | 0.007 | 0.005 | 0.005 |
| Loamy Very Fine Sand | 0.058 | 0.033 | 0.051 |
| Sand | 0.001 | 0.003 | 0.001 |
| Sandy Clay Loam | - | 0.026 | 0.026 |
| Sandy Loam | 0.018 | 0.016 | 0.017 |
| Silt Loam | 0.054 | 0.049 | 0.050 |
| Silty Clay | 0.036 | 0.034 | 0.034 |
| Silty Clay Loam | 0.046 | 0.040 | 0.042 |
| Very Fine Sand | 0.061 | 0.049 | 0.057 |
| Very Fine Sandy Loam | 0.054 | 0.044 | 0.046 |

Table B-2: Soil erodibility values (K) for common surface textures

These K estimations are based on the information obtained on approximately 1600 samples collected in Southern Ontario by Ontario Institute of Pedology surveyors.

If the organic matter content of a soil is unknown, use the value in the 'average' column. The other two columns refer to the values which can be used if the approximately organic matter content of a particular texture is known to be either greater or less than 2 percent.

(Source: Wall et al, 1997)

| Slope (%) | Slope length in meters | | | | | | | | | | | |
|-----------|------------------------|------|------|------|------|-------|-------|-------|-------|-------|-------|-------|
| | 2 | 5 | 10 | 15 | 25 | 50 | 75 | 100 | 150 | 200 | 250 | 300 |
| 0.2 | 0.04 | 0.04 | 0.04 | 0.04 | 0.04 | 0.04 | 0.04 | 0.04 | 0.04 | 0.04 | 0.04 | 0.04 |
| 0.5 | 0.07 | 0.08 | 0.08 | 0.08 | 0.08 | 0.09 | 0.09 | 0.09 | 0.09 | 0.09 | 0.09 | 0.09 |
| 1 | 0.11 | 0.12 | 0.13 | 0.13 | 0.14 | 0.15 | 0.15 | 0.16 | 0.16 | 0.16 | 0.17 | 0.17 |
| 2 | 0.18 | 0.20 | 0.22 | 0.23 | 0.25 | 0.28 | 0.29 | 0.30 | 0.32 | 0.33 | 0.35 | 0.35 |
| 3 | 0.23 | 0.27 | 0.31 | 0.33 | 0.36 | 0.41 | 0.44 | 0.47 | 0.50 | 0.53 | 0.55 | 0.57 |
| 4 | 0.27 | 0.33 | 0.39 | 0.42 | 0.47 | 0.55 | 0.60 | 0.64 | 0.70 | 0.74 | 0.78 | 0.81 |
| 5 | 0.31 | 0.39 | 0.47 | 0.52 | 0.59 | 0.70 | 0.77 | 0.83 | 0.92 | 0.99 | 1.05 | 1.10 |
| 6 | 0.35 | 0.45 | 0.54 | 0.61 | 0.70 | 0.84 | 0.94 | 1.02 | 1.14 | 1.24 | 1.32 | 1.39 |
| 8 | 0.41 | 0.55 | 0.69 | 0.78 | 0.92 | 1.15 | 1.31 | 1.43 | 1.63 | 1.79 | 1.92 | 2.03 |
| 10 | 0.48 | 0.66 | 0.84 | 0.96 | 1.15 | 1.47 | 1.69 | 1.87 | 2.15 | 2.38 | 2.57 | 2.74 |
| 12 | 0.61 | 0.86 | 1.11 | 1.29 | 1.57 | 2.03 | 2.37 | 2.64 | 3.07 | 3.42 | 3.72 | 3.99 |
| 14 | 0.70 | 1.01 | 1.33 | 1.56 | 1.91 | 2.52 | 2.96 | 3.31 | 3.89 | 4.36 | 4.77 | 5.12 |
| 16 | 0.79 | 1.16 | 1.54 | 1.82 | 2.25 | 3.00 | 3.55 | 4.00 | 4.74 | 5.33 | 5.85 | 6.31 |
| 20 | 0.96 | 1.44 | 1.96 | 2.34 | 2.94 | 4.00 | 4.79 | 5.44 | 6.51 | 7.39 | 8.16 | 8.85 |
| 25 | 1.15 | 1.77 | 2.45 | 2.96 | 3.77 | 5.22 | 6.31 | 7.23 | 8.74 | 10.01 | 11.12 | 12.11 |
| 30 | 1.33 | 2.08 | 2.92 | 3.56 | 4.57 | 6.42 | 7.84 | 9.03 | 11.01 | 12.68 | 14.15 | 15.47 |
| 40 | 1.64 | 2.64 | 3.78 | 4.67 | 6.08 | 8.72 | 10.76 | 12.50 | 15.43 | 17.91 | 20.12 | 22.11 |
| 50 | 1.91 | 3.13 | 4.55 | 5.66 | 7.45 | 10.83 | 13.47 | 15.73 | 19.57 | 22.85 | 25.77 | 28.43 |
| 60 | 2.15 | 3.56 | 5.22 | 6.54 | 8.67 | 12.71 | 15.91 | 18.65 | 23.34 | 27.36 | 30.95 | 34.23 |

Table B-3: Values for topographic factor, LS, for low ratio of rill:interill erosion, such as consolidated soil conditions with cover and rangeland (applicable to thawing soils where both inter-rill and rill erosion are significant)

(Source: Wall et al, 1997)

| Slope Steepness (%) | Slope Length Exponent, m | | |
|---------------------|--------------------------------|-----------|-------|
| | Rill/Interrill Ratio \hat{a} | | |
| | Low* | Moderate† | High‡ |
| 0.2 | 0.02 | 0.04 | 0.07 |
| 0.5 | 0.04 | 0.08 | 0.16 |
| 1 | 0.08 | 0.15 | 0.26 |
| 2 | 0.14 | 0.24 | 0.39 |
| 3 | 0.18 | 0.31 | 0.47 |
| 4 | 0.22 | 0.36 | 0.53 |
| 5 | 0.25 | 0.40 | 0.57 |
| 6 | 0.28 | 0.43 | 0.60 |
| 8 | 0.32 | 0.48 | 0.65 |
| 10 | 0.35 | 0.52 | 0.68 |
| 12 | 0.37 | 0.55 | 0.71 |
| 14 | 0.40 | 0.57 | 0.72 |
| 16 | 0.41 | 0.59 | 0.74 |
| 20 | 0.44 | 0.61 | 0.76 |
| 25 | 0.47 | 0.64 | 0.78 |
| 30 | 0.49 | 0.66 | 0.79 |
| 40 | 0.52 | 0.68 | 0.81 |
| 50 | 0.54 | 0.70 | 0.82 |
| 60 | 0.55 | 0.71 | 0.83 |

* conditions where rill erosion is slight with respect to interrill erosion; generally C factors would be less than 0.15

† conditions where rill and interrill erosion would be about equal on a 22.1 m long slope in seedbed condition on a 9% slope

‡ conditions where rill erosion is great with respect to interrill erosion; generally C factors would be greater than 7.0

Table B-4: Slope length exponents (m) for a range of slopes and rill/interrill erosion classes

(Source: McCool et al, 1989)

| # of Segments | Sequence # of Segment (i) | Soil Loss Factor (SLF) | | | | | | | | | | | | | | | | | | |
|---------------|---------------------------|------------------------|------|------|------|------|------|------|------|------|------|------|------|------|------|------|------|------|------|------|
| | | value of m | | | | | | | | | | | | | | | | | | |
| | | 0.02 | 0.06 | 0.1 | 0.15 | 0.2 | 0.25 | 0.3 | 0.35 | 0.4 | 0.45 | 0.5 | 0.55 | 0.6 | 0.64 | 0.7 | 0.75 | 0.8 | 0.85 | 0.9 |
| 2 | 1 | 0.99 | 0.96 | 0.93 | 0.90 | 0.87 | 0.84 | 0.81 | 0.78 | 0.76 | 0.73 | 0.71 | 0.68 | 0.66 | 0.64 | 0.62 | 0.59 | 0.57 | 0.55 | 0.54 |
| | 2 | 1.01 | 1.04 | 1.07 | 1.10 | 1.13 | 1.16 | 1.19 | 1.22 | 1.24 | 1.27 | 1.29 | 1.32 | 1.34 | 1.36 | 1.38 | 1.41 | 1.43 | 1.45 | 1.46 |
| 3 | 1 | 0.98 | 0.94 | 0.90 | 0.85 | 0.80 | 0.76 | 0.72 | 0.68 | 0.64 | 0.61 | 0.58 | 0.55 | 0.52 | 0.50 | 0.46 | 0.44 | 0.42 | 0.39 | 0.37 |
| | 2 | 1.01 | 1.02 | 1.02 | 1.03 | 1.04 | 1.05 | 1.05 | 1.05 | 1.06 | 1.06 | 1.06 | 1.05 | 1.05 | 1.05 | 1.04 | 1.04 | 1.03 | 1.02 | 1.02 |
| | 3 | 1.02 | 1.05 | 1.08 | 1.12 | 1.16 | 1.19 | 1.23 | 1.26 | 1.30 | 1.33 | 1.37 | 1.40 | 1.43 | 1.46 | 1.49 | 1.52 | 1.55 | 1.58 | 1.61 |
| 4 | 1 | 0.97 | 0.92 | 0.87 | 0.81 | 0.76 | 0.71 | 0.66 | 0.62 | 0.57 | 0.54 | 0.50 | 0.47 | 0.44 | 0.41 | 0.38 | 0.35 | 0.33 | 0.31 | 0.29 |
| | 2 | 1.00 | 1.00 | 1.00 | 0.99 | 0.98 | 0.97 | 0.96 | 0.95 | 0.94 | 0.93 | 0.91 | 0.90 | 0.88 | 0.87 | 0.85 | 0.84 | 0.82 | 0.80 | 0.78 |
| | 3 | 1.01 | 1.03 | 1.05 | 1.07 | 1.09 | 1.11 | 1.13 | 1.14 | 1.16 | 1.17 | 1.18 | 1.19 | 1.20 | 1.21 | 1.22 | 1.23 | 1.23 | 1.24 | 1.24 |
| | 4 | 1.02 | 1.05 | 1.09 | 1.13 | 1.17 | 1.21 | 1.25 | 1.29 | 1.33 | 1.36 | 1.40 | 1.44 | 1.48 | 1.50 | 1.55 | 1.58 | 1.62 | 1.65 | 1.68 |
| 5 | 1 | 0.97 | 0.91 | 0.85 | 0.79 | 0.72 | 0.67 | 0.62 | 0.57 | 0.53 | 0.48 | 0.45 | 0.41 | 0.38 | 0.36 | 0.32 | 0.30 | 0.28 | 0.25 | 0.23 |
| | 2 | 1.00 | 0.99 | 0.97 | 0.96 | 0.94 | 0.92 | 0.90 | 0.88 | 0.86 | 0.84 | 0.82 | 0.80 | 0.77 | 0.76 | 0.73 | 0.71 | 0.69 | 0.66 | 0.64 |
| | 3 | 1.01 | 1.02 | 1.03 | 1.04 | 1.04 | 1.05 | 1.05 | 1.06 | 1.06 | 1.06 | 1.06 | 1.06 | 1.05 | 1.05 | 1.05 | 1.04 | 1.03 | 1.03 | 1.02 |
| | 4 | 1.01 | 1.04 | 1.06 | 1.09 | 1.12 | 1.14 | 1.17 | 1.19 | 1.21 | 1.23 | 1.25 | 1.27 | 1.29 | 1.30 | 1.32 | 1.34 | 1.35 | 1.37 | 1.38 |
| | 5 | 1.02 | 1.05 | 1.09 | 1.13 | 1.17 | 1.22 | 1.26 | 1.30 | 1.34 | 1.38 | 1.42 | 1.46 | 1.50 | 1.53 | 1.58 | 1.62 | 1.65 | 1.69 | 1.73 |

Table B-5: Soil loss factors (SLF) for irregular slopes

(Source: Wall et al, 1997)

| Type of mulch | Mulch rate tons/acre | Land slope percent | C Factor | Length limit (feet) |
|---|-------------------------|-----------------------|----------|------------------------|
| None | 0 | all | 1 | - |
| Straw or hay, tied down by anchoring and tacking equipment | 1 | 1.5 | 0.20 | 200 |
| | 1 | 6-10 | 0.20 | 100 |
| | 1.5 | 1.5 | 0.12 | 300 |
| | 1.5 | 6-10 | 0.12 | 150 |
| | 2 | 1.5 | 0.06 | 400 |
| | 2 | 6-10 | 0.06 | 200 |
| | 2 | 11-15 | 0.07 | 150 |
| | 2 | 16-20 | 0.11 | 100 |
| | 2 | 21-25 | 0.14 | 75 |
| | 2 | 26-33 | 0.17 | 50 |
| Crushed stone, 1/4 to 1 1/2 inch | 2 | 34-50 | 0.20 | 35 |
| | 135 | <16 | 0.05 | 200 |
| | 135 | 16-20 | 0.05 | 150 |
| | 135 | 21-33 | 0.05 | 100 |
| | 135 | 34-50 | 0.05 | 75 |
| | 240 | <21 | 0.02 | 300 |
| | 240 | 21-33 | 0.02 | 200 |
| Wood chips | 240 | 34-50 | 0.02 | 150 |
| | 7 | <16 | 0.08 | 75 |
| | 7 | 16-20 | 0.08 | 50 |
| | 12 | <16 | 0.05 | 150 |
| | 12 | 16-20 | 0.05 | 100 |
| | 12 | 21-33 | 0.05 | 75 |
| | 25 | <16 | 0.02 | 200 |
| | 25 | 16-20 | 0.02 | 150 |
| | 25 | 21-33 | 0.02 | 100 |
| | 25 | 34-50 | 0.02 | 75 |

Table B-6a: C-Factors for mulch placement and respective slope length limits

(Source: Wall et al, 1997)

| Treatment | C-Factor |
|----------------------------------|--------------------------|
| Sod Grass | 0.01 |
| Temporary Vegetation/Cover Crop | 0.45 ¹ |
| Hydraulic Mulch at 4.5 tonnes/ha | 0.10 ² |
| Soil Sealant | 0.10 – 0.60 ³ |
| Rolled Erosion Control Products | 0.10 – 0.30 ³ |

- Notes:
- ¹ Assumes planting occurs within optimal climatic conditions
 - ² Some limitation on use in arid and semiarid climates
 - ³ Value used must be substantiated by documentation.

Table B-6b: C-Factors for Other Treatments

| Treatment | P- Factor |
|--|------------------------|
| Bare Soil | |
| Packed and smooth | 1.00 |
| Freshly disked or rough, irregular | 0.90 |
| Sediment Containment Systems (a.k.a. Sediment Trap / Basin) | 0.10-0.90 ^A |
| Bale or Sandbag Barriers | 0.90 |
| Rock (Diameter = 25 - 50 mm) Barriers at Sump Location | 0.80 |
| Silt - Fence Barriers | 0.60 |
| Contour Furrowed Surface | |
| Must be maintained throughout construction activities, otherwise P-Factor =1.0, Maximum length refers to downslope length | |
| Slope (%) | Max. Length (m) |
| 1 to 2 | 120 |
| 3 to 5 | 90 |
| 6 to 8 | 60 |
| 9 to 12 | 40 |
| 13 to 16 | 25 |
| 17 to 20 | 20 |
| >20 | 15 |
| | 0.60 |
| | 0.50 |
| | 0.50 |
| | 0.60 |
| | 0.70 |
| | 0.80 |
| | 0.80 |
| Terracing | |
| Must contain 2-year runoff volumes without overflowing, otherwise P-Factor = 1.00 | |
| Slope (%) | |
| 1 to 2 | 0.12 |
| 3 to 8 | 0.10 |
| 9 to 12 | 0.12 |
| 13 to 16 | 0.14 |
| 17 to 20 | 0.16 |
| >20 | 0.18 |
| Grass Buffer Strips to Filter Sediment-laden Sheet Flows | |
| Strips must be at least 15 m (50 ft) wide and have a groundcover value of 65% or great, otherwise P-Factor =1.00 | |
| Basin Slope (%) | |
| 0 to 10 | 0.60 |
| 11 to 24 | 0.80 |

A. Should be constructed as the first step in over lot grading.

Note: Use of P-Factor values not in this table must be supported by documentation.

Table B-7: P-Factor Values for Construction Site

(Source: Fifield 2001) (part)
(Source: Wall et al, 1997) (part)

THIS PAGE LEFT BLANK INTENTIONALLY.

APPENDIX C

**EROSION AND SEDIMENTATION CONTROL
BEST MANAGEMENT PRACTICES (BMPs)**

THIS PAGE LEFT BLANK INTENTIONALLY.

INTRODUCTION

A revised List of Tables and List of BMPs have been included in this 2011 edition of the Erosion and Sediment Control Manual. New items have been **bolded** in this list.

Items which have undergone change from the 2003 edition are:

| 2003 BMP Number | 2003 BMP Name | Type of Change |
|----------------------------|---|-----------------------|
| 3. | Brush or Rock Filter Berm | Removed |
| 4. | Continuous (earth-filled geotextile) Berm | Revised |
| 5. | Earth Dyke Barrier | Revised |
| 8. | Aggregate Filled Sand Bag Check Dam | Removed |
| 9. | Log Check Dam | Removed |
| 10. | Synthetic Permeability (Ditch) Barrier | Revised |
| 11. | Straw Bale Check Dam | Removed |
| 16. | Gravel Blankets | Removed |
| 24. | Hydroseeding-Hydromulching | Revised |
| 28. | Fibre Rolls and Wattles | Revised |
| 29. | Chemical Stabilization (Tackifiers) | Removed |

All BMPs had a general review. However, the major changes to the 2011 edition of the ESC Manual are:

- Adding new Streambank Stabilization Techniques
- Categorizing BMPs into Erosion Control, Sediment Control and Streambank Stabilization Techniques
- Removing, adding, and revising various BMPs

Users of this manual are cautioned that these BMPs are for guidance only and that a specific site design is required by the engineer or designer.

LIST OF TABLES

| | |
|-----------|--|
| Table C-1 | Erosion Control Measures – Source Control |
| Table C-2 | Erosion Control Measures – Runoff Control |
| Table C-3 | Sediment Control Measures |
| Table C-4 | Streambank Applications |
| Table C-5 | Procedural BMPs (Planning Strategies) for Erosion and Sediment Control |

LIST OF BMPs

Erosion Control

| <u>BMP #</u> | <u>BMP Description</u> |
|--------------|--|
| 13 | Rolled Erosion Control Products (RECP) |
| 14 | Riprap Armouring |
| 15 | Cellular Confinement System |
| 21 | Offtake Ditch |
| 22 | Seeding |
| 25 | Topsoiling |
| 26 | Sodding |
| 34 | Slope Texturing |
| 36 | Polyacrylamide (PAM) |
| 37 | Compost Blanket |

Sediment Control

| <u>BMP #</u> | <u>BMP Description</u> |
|--------------|---|
| 1 | Silt Fence |
| 4 | Continuous Perimeter Control Structures |
| 5 | Berm Interceptor |
| 6 | Storm Drain Inlet Sediment Barrier |
| 12 | Straw Bale Barrier |
| 17 | Energy Dissipators |
| 18 | Sediment Traps and Basins |
| 19 | Slope Drains |
| 20 | Groundwater Control |
| 38 | Rolls |
| 38 | Wattles (Live Fascine) |

Erosion and Sediment Control

| <u>BMP #</u> | <u>BMP Description</u> |
|---------------------|--------------------------------------|
| 2 | Gabions |
| 7 | Rock Check Dam |
| 10 | Synthetic Permeable Barrier |
| 23 | Mulching |
| 24a | Hydroseeding |
| 24b | Hydromulching |
| 30 | Riparian Zone Preservation |
| 31 | Pumped Silt Control Systems |
| 32 | Scheduling |
| 33 | Stabilized Worksite Entrances |
| 35 | Straw Mulching & Crimping |

Streambank Stabilization Techniques

| <u>BMP #</u> | <u>BMP Description</u> |
|---------------------|---|
| 27a | Live Staking |
| 27b | Brushlayering |
| 38 | Rolls |
| 39 | Brush Mattress |
| 40 | Live Siltation |
| 41 | Willow Post and Poles |
| 42 | Rock Vanes |
| 43 | Longitudinal Stone Toe |
| 44 | Vegetated Mechanical Stabilized Earth (VMSE) |
| 45 | Vegetated Riprap |

DRAWING LISTING

| <u>BMP</u> | <u>Drawing Description</u> |
|-------------------------|--|
| <u>Drawing #</u> | |
| 1 | Silt Fence |
| 2a | Gabions (Slope and Bank) |
| 2b | Gabions (Single Gabion) Drop Structure for Ditch Channel |
| 2c | Gabions (Double Gabion) "Energy Dissipator" Drop Structure for Ditch Channel |
| 5 | Berm Interceptor |
| 6a | Storm Drain Drop Inlet Sediment Barrier (Block and Gravel – Option 1) |
| 6b | Storm Drain Curb Inlet Sediment Barrier (Block and Gravel – Option 2) |
| 6c | Storm Drain Curb Inlet Sediment Barrier (Sandbags – Option 1) |
| 6d | Storm Drain Curb and Gutter Sediment Barrier (Sandbags – Option 2) |
| 6e | Storm Drain Drop Inlet Sediment Barrier (Straw Bale/Gravel Option) |
| 6f | Storm Drain Drop Inlet Sediment Barrier (Silt Fence – Option) |
| 7 | Rock Check Dam |
| 10 | Synthetic Permeable Barriers |
| 12 | Straw Bale Barrier |

| <u>BMP</u> | <u>Drawing Description</u> |
|-------------------------|---|
| <u>Drawing #</u> | |
| 13a | Rolled Erosion Control Product (RECP) Channel Installation |
| 13b | Rolled Erosion Control Product (RECP) Slope Installation |
| 14a | Riprap Armouring for Slope |
| 14b | Riprap Armouring for Channel |
| 15 | Cellular Confinement System for Slope Stabilization |
| 17a | Energy Dissipator for Culvert Outlet |
| 17b | Energy Dissipator for Semi-Circular Trough Drain Terminal Protection for Bridge Headslope |
| 18a | Typical Sediment Basin (Riser Outlet Option) |
| 18b | Typical Sediment Basin (Permeable Rock Berm Outlet Option) |
| 19a | Slope Drain |
| 19b | Overside Drain |
| 21 | Offtake Ditch (Intercept Ditch) |
| 27a | Live Staking |
| 27b1 | Brushlayering with Rock Toe Protection |
| 27b2 | Brushlayering |
| 27b3 | Brushlayering |
| 28 | Wattle (Live Fascine) |
| 31 | Pumped Silt Control System |
| 33 | Temporary Gravel Construction Entrance/Exit |
| 34a | Surface Roughening |
| 34b | Grooved or Serrated Slope |
| 34c | Benched Slope |
| 35 | Straw Mulching and Crimping (Straw Anchoring) |
| 38a | Coir Roll with Brushlayering |
| 38b | Coir Roll / Coir Mats |
| 38c | Straw Rolls |
| 39 | Brush Mattress |
| 40 | Live Siltation |
| 41 | Willow Posts and Poles |
| 42a | Rock Vanes |
| 42b | Typical Vane Bank Key Detail (With Pole Planting) |
| 43 | Longitudinal Stone Toe |
| 44 | Vegetated Mechanically Stabilized Earth (Step by Step) |
| 45a | Vegetated Riprap with Brushlayering and Pole Planting |
| 45b | Vegetated Riprap Willow Bundle Method (Horizontal) |
| 45c | Vegetated Riprap Bent Pole Method (Horizontal) |
| 45d | Vegetated Riprap During Construction Summary of Techniques |

Table C-1: Erosion Control Measures - Source Control

| No. | BMP Name | Applications | | | | Comments | |
|------------|------------------------------|--------------|----------------------|--------------------------|---------------------------|---|---|
| | | Slopes | Ditches and Channels | Large Flat Surface Areas | Borrow and Stockpile Area | Advantages | Limitations |
| 25 | Topsoiling | ✓ | ✓ | ✓ | ✓ | Placing topsoil provides excellent medium for vegetation root structure development, organic content promotes plant growth, reuse organics (topsoil or peat) stripped from the site at start of grading; absorbs raindrop energy to minimize erosion potential | Cannot be effective without seeding and allowing time for plant growth; not appropriate for slopes steeper than 2H:1V (steep slopes will require soil covering over topsoil and specialized design); dry topsoil susceptible to wind erosion, susceptible to erosion prior to establishment of vegetation |
| 22 | Seeding | ✓ | ✓ | ✓ | ✓ | Inexpensive and relatively effective erosion control measure, effectiveness increases with time as vegetation develops, aesthetically pleasing, enhances terrestrial and aquatic habitat | Must be applied over prepared surface (topsoiled), grasses may require periodic maintenance (mowing), uncut dry grass may be a fire hazard, seeding for steep slopes may be difficult, seasonal limitations on seeding effectiveness may not coincide with construction schedule, freshly seeded areas are susceptible to runoff erosion until vegetation is established, reseeding may be required for areas of low growth |
| 23 | Mulching | ✓ | ✓ | ✓ | ✓ | Used alone to protect exposed areas for short periods, protects soil from rainsplash erosion, preserves soil moisture and protects germinating seed from temperature extremes, relatively inexpensive measure of promoting plant growth and slope protection | Application of mulch on steep slopes may be difficult, may require additional specialized equipment May deplete available nitrogen Nitrogen rich fertilizer may need to be added |
| 24a 24b | Hydroseeding / Hydromulching | ✓ | ✓ | ✓ | ✓ | Economical and effective on large areas, mulch tackifier may be used to provide immediate protection until seed germination and vegetation is established, allows re-vegetation of steep slopes where conventional seeding/mulching techniques are very difficult, relatively efficient operation, also provides wind erosion control | Site must be accessible to hydroseeding / hydromulching equipment (usually mounted on trucks with a maximum hose range of approximately 150 m), may require subsequent application in areas of low growth as part of maintenance program |

Table C-1: Erosion Control Measures - Source Control

| No. | BMP Name | Applications | | | | Comments | |
|-----|--|--------------|----------------------|--------------------------|---------------------------|---|---|
| | | Slopes | Ditches and Channels | Large Flat Surface Areas | Borrow and Stockpile Area | Advantages | Limitations |
| 26 | Sodding | ✓ | ✓ | ✓ | ✓ | Provides immediate vegetation and protection, instant buffer strip and/or soft channel lining, can be used on steep slopes, relatively easy to install, may be repaired if damaged, aesthetically pleasing | Expensive, labour intensive to install, sod may not be readily available in all areas of the province, relatively short 'shelf-life' (sod can't be stored on-site for excessive periods of time) |
| 14 | Riprap Armouring | ✓ | ✓ | | | Most applicable as channel lining with geotextile underlay, used for soils where vegetation not easily established, effective for high velocities or concentrations, permits infiltration, dissipates energy of flow from culvert inlets/outlets, easy to install and repair, very durable and virtually maintenance free | Expensive, may require heavy equipment to transport and place rock, may not be feasible in areas of the province where rock is not readily available, may be labour intensive to install (hand installation); generally thickness of riprap is higher when compared to gabion mattress |
| 13 | Rolled Erosion Control Products (RECP) | ✓ | ✓ | | | Provides a protective covering to bare soil or topsoiled surface where need of erosion protection is high, can be more uniform and longer lasting than mulch, wide range of commercially available products | RECP use is labour intensive to install, temporary blankets may require removal prior to restarting construction activities, RECP not suitable for rocky slopes, proper site preparation is required to seat RECP onto soil correctly; high performance is tied to successful vegetation growth |
| 15 | Cellular Confinement System | ✓ | ✓ | | ✓ | Lightweight cellular system and easily installed, uses locally available soils or grout for fill to reduce costs | Not commonly used in Alberta highway construction, expensive, installation is labour intensive (hand installation), not suitable for slopes steeper than 1H:1V |
| 27a | Live Staking | ✓ | | ✓ | ✓ | Establishes vegetative cover and root mat, reduces flow velocities on vegetative surface, traps sediment laden runoff, aesthetically pleasing once established, grows stronger with time as root structure develops, usually has deeper root structure than grass | Expensive, may be labour intensive to install, not commonly used in Alberta highway construction projects, revegetated areas are subject to erosion until plants are established, plants may be damaged by wildlife, watering is usually required until plants are established |

Table C-1: Erosion Control Measures - Source Control

| No. | BMP Name | Applications | | | | Comments | |
|-----|---|--------------|----------------------|--------------------------|---------------------------|--|--|
| | | Slopes | Ditches and Channels | Large Flat Surface Areas | Borrow and Stockpile Area | Advantages | Limitations |
| 30 | Riparian Zone Preservation | ✓ | ✓ | ✓ | ✓ | Preserve a native vegetation buffer to filter and slow runoff before entering sensitive (high risk) areas, most effective natural sediment control measure, slows runoff velocity, filters sediment from runoff, reduces volume of runoff on slopes | Freshly planted vegetation for newly created riparian zones requires substantial periods of time before they are as effective as established vegetation at controlling sediment |
| 32 | Scheduling | ✓ | ✓ | ✓ | ✓ | Identifies protection issues and plans for efficient, orderly construction of BMPs; minimizes bare soil exposure and erosion hazard; allows early installation of perimeter control for sediment entrapment; and early installation of runoff control measures | |
| 34 | Slope Texturing | ✓ | | | ✓ | Roughens slope surface to reduce erosion potential and sediment yield; suitable for clayey soils | Additional cost; not suitable for silty and sandy soils; not practical for slope length <8 m for dozer operation up/down slope |
| 36 | Polyacrylamide (PAM) | ✓ | ✓ | | ✓ | Increase cohesion of soil particles, thus enhancing terrestrial and aquatic habitat and improving water quality | Not for application to surface waters. Not commonly used in highway construction projects and may be expensive. Treatment area must be accessible to spray equipment. Temporary measure only. Performance decreases due to exposure to UV light and time |
| 35 | Straw Mulching & Crimping (Straw Anchoring) | ✓ | | | ✓ | Economical method of promoting plant growth and slope protection | Availability of straw. "Punching" of straw does not work on sandy soils. Application of straw by hand is labour intensive. If using straw blowers, treatment area must be accessible to trucks for transport of weeds |
| 37 | Compost Blanket | ✓ | | ✓ | ✓ | Economical. Appropriate on slopes 2H:1V to level surface. | Application on steep slopes may be difficult. Treatment area should be accessible to blower trucks |

Table C-2: Erosion Control Measures - Runoff Control

| No. | BMP Name | Applications | | | | Comments | |
|-----|-------------------|--------------|----------------------|--------------------------|---------------------------|---|---|
| | | Slopes | Ditches and Channels | Large Flat Surface Areas | Borrow and Stockpile Area | Advantages | Limitations |
| 34 | Slope Texturing | ✓ | | ✓ | ✓ | Contouring and roughening (tracking) of slope face reduces runoff velocity and increases infiltration rates; collects sediment; holds water, seed and mulch better than smooth surfaces; promotes development of vegetation, provides loss of soil reduction in soil erosion compared with untracked slopes | May increase grading costs, may cause sloughing in sensitive (wet) soils, tracking may compact soil, provides limited sediment and erosion control and should not be used as primary control measure |
| 21 | Offtake Ditch | ✓ | | ✓ | ✓ | Collects and diverts sheet flow or runoff water at the top of a slope to reduce downslope erosion potential, incorporated with permanent project drainage systems | Channel must be sized appropriately to accommodate anticipated flow volumes and velocities, lining may be required, may require design by qualified personnel, must be graded to maintain positive drainage to outlets to minimize ponding |
| 17 | Energy Dissipator | ✓ | ✓ | | | Slows runoff velocity and dissipate flow energy to non-erosive level in relatively short distances, permits sediment collection from runoff | Small diameter rocks/stones can be dislodged; grouted riprap armouring may breakup due to hydrostatic pressures, frost heaves, or settlement; may be expensive, may be labour intensive to install; may require design by qualified personnel for extreme flow volumes and velocities |
| 19 | Slope Drains | ✓ | | | | Directs surface water runoff into drain pipe instead of flowing over and eroding exposed soils of slope face | Must be sized appropriately to accommodate anticipated flows, erosion can occur at inlet/outlet if protection is not incorporated into design, slope drain must be anchored to slope |

Table C-2: Erosion Control Measures - Runoff Control

| No. | BMP Name | Applications | | | | Comments | |
|-----|--|--------------|----------------------|--------------------------|---------------------------|--|---|
| | | Slopes | Ditches and Channels | Large Flat Surface Areas | Borrow and Stockpile Area | Advantages | Limitations |
| 2 | Gabions | | ✓ | | | Relatively maintenance free, permanent drop structure, long lasting (robust), may be less expensive than riprap, allows smaller diameter rock/stones to be used, relatively flexible, commercially available products, commonly used in Alberta highway construction projects; suitable for resisting high flow velocity | Construction may be labour intensive (hand installation), extra costs associated with gabion basket materials |
| 7 | Rock Check Dam | | ✓ | | ✓ | Permanent drop structure with some filtering capability, cheaper than gabion and armouring entire channel, easily constructed, commonly used in Alberta highway construction projects | Can be expensive in areas of limited rock source, not appropriate for channels draining areas larger than 10 ha (4 acres), requires extensive maintenance after high flow storm events, susceptible to failure if water undermines or outflanks structure |
| 10 | Synthetic Permeable Barriers | | ✓ | | | Reusable/moveable, reduces flow velocities and dissipate flow energy; retains some sediments; used as grade breaks in conjunction with sturdy permanent drop structures along steep grades | Not to be used as check structures, must be installed by hand in conjunction with RECP, become brittle in winter and are easily damaged by construction equipment or recreational vehicles, only partially effective in retaining some sediment, primarily used for reducing flow velocities and energy dissipation |
| 20 | Groundwater Control (Subsurface Drain) | ✓ | | | | Relief subsurface groundwater seepage and winter ice build-up; lower groundwater table to minimize piping erosion; enhance slope stability performance | Requires design by a qualified person; can be a slope instability issue |

Table C-2: Erosion Control Measures - Runoff Control

| No. | BMP Name | Applications | | | | Comments | |
|----------|--------------------------|--------------|----------------------|--------------------------|---------------------------|--|---|
| | | Slopes | Ditches and Channels | Large Flat Surface Areas | Borrow and Stockpile Area | Advantages | Limitations |
| 38 28 | Rolls (Fibre) Wattles | ✓ | | | | Function well in freeze-thaw conditions, low cost solution to sheet flow and rill erosion on slopes, low to medium cost flow retarder and silt trap, can be used on slopes too steep for silt fences or straw bale barriers, biodegradable | Labour intensive to install (hand installation), designed for slope surfaces with low flow velocities, designed for short slope lengths with a maximum slope of 2H:1V, not widely used on Alberta highway construction projects |
| 37 | Compost Blanket | ✓ | | ✓ | ✓ | Economical. Appropriate on slopes 2H:1V to level surface | Application on steep slopes may be difficult. Treatment area should be accessible to blower trucks |

Table C-3: Sediment Control Measures

| No. | BMP Name | Applications | | | | Comments | |
|-----|---|--------------|----------------------|--------------------------|---------------------------|--|---|
| | | Slopes | Ditches and Channels | Large Flat Surface Areas | Borrow and Stockpile Area | Advantages | Limitations |
| 30 | Riparian Zone Preservation | ✓ | ✓ | ✓ | ✓ | Preserve a native vegetation buffer to filter and slow runoff before entering sensitive (high risk) areas, most effective natural sediment control measure, slows runoff velocity, filters sediment from runoff | Freshly planted vegetation for newly created riparian zones requires substantial periods of time before they are as effective as established vegetation at controlling sediment |
| 12 | Straw Bale Barrier | | ✓ | ✓ | ✓ | Relatively inexpensive if bales are locally available, biodegradable, cheaper and easier to install than other barriers | Short service life due to biodegradation, straw bales may not be readily available in all areas of the province, maximum barrier height of one straw bale, require extensive maintenance after high flow storm events, require proper keying and staking |
| 38 | Rolls (Fibre) | | | | | Function well in freeze-thaw conditions, low cost solution to sheet flow and rill erosion on slopes, low to medium cost flow retarder and silt trap, can be used on slopes too steep for silt fences or straw bale barriers, biodegradable | Labour intensive to install (hand installation), designed for slope surfaces with low flow velocities, designed for short slope lengths with a maximum slope of 2H:1V, not widely used on Alberta highway construction projects |
| 28 | Wattles | ✓ | | | | | |
| 31 | Pumped Silt Control Systems (Silt Bags) | | ✓ | | | Filter bag is lightweight and portable, simple set up and disposal, sediment-laden water is pumped into this filter bag, different aperture opening sizes (AOS) available from several manufacturers; normally for emergency use only | May be expensive, requires special design, not usually readily used in Alberta highway construction projects, requires a pump and power source for pump, suitable for only short periods of time and small volumes of sediment laden water, can only remove particles larger than aperture opening size (AOS) |
| 1 | Silt Fence | ✓ | | ✓ | ✓ | Economical, most commonly used sediment control measure allows water to pond and settle out coarse grained sediment, more effective than straw bale barriers | May fail under high runoff events, applicable for sheet flow erosion only, limited to locations where adequate space is available to pond collected runoff, sediment build up needs to be removed on a regular basis, damage to silt fence may occur during sediment removal, usable life of approximately one year |

Table C-3: Sediment Control Measures

| No. | BMP Name | Applications | | | | Comments | | |
|-----|--------------------------|---|----------------------|--------------------------|---------------------------|------------|--|---|
| | | Slopes | Ditches and Channels | Large Flat Surface Areas | Borrow and Stockpile Area | Advantages | Limitations | |
| 5 | Filtering and Entrapment | Berm Interceptor | ✓ | | ✓ | | Easy to construct, relatively inexpensive as local soil and material is used | Geotechnical design required for fill heights in excess of 3 m, may not be suitable for all soil types or sites; riprap spillway and/or permeable outlet may be required |
| 2 | | Gabions | | ✓ | | | Relatively maintenance free, permanent drop structure, long lasting (robust), may be less expensive and thickness than riprap, allows smaller diameter rock/stones to be used, relatively flexible, commercially available products, commonly used in Alberta highway construction projects; suitable for resisting high flow velocity | Construction may be labour intensive (hand installation), extra costs associated with gabion basket materials |
| 7 | | Rock Check Dam | | ✓ | | ✓ | Permanent drop structure with some filtering capability, cheaper than gabion and armouring entire channel, easily constructed, commonly used in Alberta highway construction projects | Can be expensive in areas of limited rock source, not appropriate for channels draining large areas, requires extensive maintenance after high flow storm events, susceptible to failure if water undermines or outflanks structure |
| 10 | Filtering and Entrapment | Synthetic Permeable Barriers | | ✓ | | | Reusable/moveable, reduces flow velocities and dissipates flow energy; retains some sediments; used as grade breaks in conjunction with sturdy permanent drop structures along steep grades | Partially effective as check dam structure, must be installed by hand in conjunction with RECP, become brittle in winter and are easily damaged by construction equipment or recreational vehicles, only partially effective in retaining some sediment, primarily used for reducing flow velocities and energy dissipation |
| 4 | | Continuous Perimeter Control Structures | ✓ | | ✓ | ✓ | Temporary measure; divert and intercept sheet or overlaid flow to form pond and allow sedimentation; flexibility of shape of construction; no trenching | Require specialized continuous berm machine to manufacture earth-filled geotextile berm on site; sandy/gravel soil is preferable fill material |
| 6 | | Storm Drain Inlet/Sediment Barrier | | | ✓ | | Temporary measure; easy to install and remove | Limited sediment entrapment capacity; requires regular clean-out maintenance |

Table C-3: Sediment Control Measures

| No. | BMP Name | | Applications | | | | Comments | |
|-----|-------------|-----------------------|--------------|----------------------|--------------------------|---------------------------|---|---|
| | | | Slopes | Ditches and Channels | Large Flat Surface Areas | Borrow and Stockpile Area | Advantages | Limitations |
| 37 | | Compost Blanket | ✓ | | ✓ | ✓ | Economical. Appropriate on slopes 2H:1V to level surface | Application on steep slopes may be difficult. Treatment area should be accessible to blower trucks |
| 32 | All BMPs | Scheduling | ✓ | ✓ | ✓ | ✓ | Identifies protection issues and plans for efficient, orderly construction of BMPs; early installation of perimeter control for sediment entrapment; early dimension planning of runoff control measures | |
| 18 | Impoundment | Sediment Traps/Basins | | ✓ | | ✓ | May be constructed of a variety of materials, collects sediment laden runoff and reduces velocity of flow and deposition of sediment, can be cleaned and expanded as needed, capable of handling large volumes of sediment laden runoff | "Last resort" measure. Normally requires 250 m ³ /ha storage volume per area of exposed soil, Can require large areas of land, requires periodic maintenance to remove sediment build up, requires design by qualified personnel, usually requires 'back-up' control measures in case pond/basin overflows |

Table C-4: Streambank Applications

| BMP # and Name | Comments | |
|---------------------------------------|--|---|
| | Advantages | Limitations |
| #27a Live Staking | Establishes vegetative cover and root mat, reduces flow velocities on vegetative surface, traps sediment laden runoff, aesthetically pleasing once established, grows stronger with time as root structure develops, usually has deeper root structure than grass | Expensive, may be labour intensive to install, not commonly used in Alberta highway construction projects, revegetated areas are subject to erosion until plants are established, plants may be damaged by wildlife, watering is usually required until plants are established |
| #27b Brushlayering | Provide immediate soil stability and habitat Can be used with other toe protection such as, rootwads, coir rolls, and log toes. Combining live brushlayering with rock toes is an effective and relatively low cost technique for revegetating and stabilizing streambanks. Provides a source of shade and nutrients, while slowing velocities along the bank during flooding flows. They provide a flexible strengthening system to fill slopes. Act as horizontal drains and favourably modify the soil water flow regime | Live cuttings are most effective when implemented during the dormancy period of chosen plant species. Brushlayers are vulnerable to failure before rooting occurs, and they are not effective at counteracting failure along very deep-seated failure planes |
| #39 Brush Mattress | Provides a dense network of branches that quickly stabilize a slope or streambank. Will trap sediments during high water and eventual plant growth will enhance aquatic habitat. Well suited for combined installation with many other streambank or slope stabilization techniques such as Vegetated Riprap, Live Stakes, Live Fascines, Rootwad Revetment, Live Siltation, and Coconut Fibre Rolls. Provides immediate surface protection against floods, greatly reducing water velocity at the soil surface. Cuttings are usually available locally. Relatively economical technique. Captures sediment during floods, assisting in rebuilding of bank. Produces riparian vegetation rapidly and enhances wildlife habitat value | Does not show high success on streams where basal ends cannot be kept wet for the duration of the growing season. They should be installed during the dormant season for woody vegetation and Installation is labour intensive |
| #40 Live Siltation | A very effective and simple conservation method using local plant materials. Can be constructed in combination with rock toes, Rootwad Revetments, Coconut Fibre Rolls, Live Fascines, and Brush Mattresses. Valuable for providing immediate cover and fish habitat while other revegetation plantings become established. The protruding branches provide roughness, slow velocities, and encourage deposition of sediment. The depositional areas are then available for natural recruitment of native riparian vegetation | If using a living system, cuttings must be taken during the dormancy period |
| #41 Willow Posts and Poles | Willow posts and poles are inexpensive to acquire, install, and maintain, provide long-term protection. They may be inserted into stone or soil backfill and thus become incorporated with the structure as they root. They can also be incorporated into many techniques during construction (e.g., Vegetated Riprap, Vegetated Gabions), and can be planted in the keyways of many structures. Aquatic and terrestrial habitat is provided and/or improved. Willows act as pioneer species, and allow other plant species to colonize the area after the willows have become established | Willow posts and poles have higher survival rates when planted during their dormant season, so planning should be adjusted accordingly. Optimum stabilization is not achieved until the willows become established, typically at least one season after installation, although they provide some reinforcement immediately following installation |

Table C-4: Streambank Applications

| BMP # and Name | Comments | |
|---------------------------------------|--|---|
| | Advantages | Limitations |
| #42 Rock Vanes | <p>Rock vanes can successfully reduce near-bank velocities and shear stress, vegetation establishment is greatly improved. Vanes are often combined with other biotechnical soil stabilization measures for bank areas between the vanes. Provide aquatic habitats superior to resistive, continuous structures like Riprap and Longitudinal Stone Toe. Controlled scour at the vane tip, the creation of pool/riffle bed complexity, and increased deposition of the upstream end are the major environmental benefits of vanes. Vanes provide fish rearing and benthic habitat, creates or maintains pool and riffle habitat, provides cover and areas for adult fish, and velocity refugia.</p> <p>The redirection of impinging flows away from the bank and the sedimentation on the upstream side of the vane creates areas where vegetation can effectively re-establish. Areas of active bank erosion become depositional, vegetate, and subsequently, become permanently stable. The technique is appropriate under a range of flow conditions and bed materials and can be used in series to redirect flows around bends. Vane installation does not require extensive bank reshaping, and most heavy equipment work can be done from the top of the bank, further reducing site disturbance. Vanes require less rock and heavy equipment than riprap for a similar length of protected bank.</p> | <p>Unintended impacts can result from improper design and construction. If the vane is not properly keyed into the bank, it is likely to fail, creating new localized erosion problems. Improper vane angle and crest elevation can redirect flow in unintended directions, triggering downstream erosion</p> |
| #43 Longitudinal Stone Toe | <p>Willow posts and poles may be incorporated into key sections and used to revegetate the middle and upper bank above stone toe. May be combined with a number of other different techniques and the results enhance aquatic habitats. Longitudinal Stone Toe with Spurs is a variation on this technique. Bank grading, reshaping, or sloping is usually not needed (existing bank and overbank vegetation need not be disturbed or cleared), nor is a filter cloth or gravel filter needed. If stone is placed from the water side, existing bank vegetation need not be disturbed. It is very cost-effective and is relatively easy to design, specify and construct. It is easily combined with other bank stability techniques that provide superior habitat compared to pure riprap</p> | <p>Only provides toe protection and does not protect mid- and upper bank areas. Some erosion of these areas should be anticipated during long-duration, high energy flows, or until the areas become otherwise protected. Stone toe is not suitable for reaches where rapid bed degradation (lowering) is likely, or where scour depths adjacent to the toe will be greater than the height of the toe.</p> |

Table C-4: Streambank Applications

| BMP # and Name | Comments | |
|---|---|---|
| | Advantages | Limitations |
| #44 Vegetated Mechanically Stabilized Earth (VMSE) | <p>The presence of vegetation softens the stark visual appearance of conventional mechanically stabilized earth structures and provides potential habitat for riparian wildlife. Overhanging branches of the live brushlayers provide shade for fish and a substrate for insects and other organisms that the fish feed upon. They permit much steeper slopes to be constructed than would be possible with live brushlayers alone. Brushlayering treatment by itself is normally restricted to slopes no steeper than 1V:2H. VMSE can be constructed with a slope as steep as 1V:0.5H. The vegetation shields the fabric against damaging UV radiation, and provides visual and riparian habitat benefits. The brushlayers act as horizontal drains that favourably modify the groundwater regime in the vicinity of the slope face, thereby improving stability against mass slope failure</p> | <p>A VMSE structure must be constructed during the dormancy period to insure good vegetative propagation and establishment. Alternatively, the live cuttings may be harvested during dormancy, and placed in temporary cold storage until they are ready for use during an out-of-dormancy period, viz., during the summer months (increases the cost). Materials procurement is more demanding, and installation more complex, because of the blending of two distinct methods, viz., conventional MSE and live brushlayering, into a single approach. Costs will also be more than brushlayering used alone, because of the added expense of the geotextile and the additional labour required to handle and construct the wraps. VMSE streambank structures must be constructed during periods of low water because of the need to excavate and backfill a trench with rock in the streambed to provide a stable foundation.</p> |
| #45 Vegetated Rip-Rap | <p>When graded or "self-launching" stone are used, riprap is self-adjusting to small amounts of substrate consolidation or movement. The revetment can sustain minor damage and still continue to function adequately without further damage. The rough surface of the riprap dissipates local currents and minimizes wave action more than a smooth revetment (like concrete blocks). Stones are readily available in most locations, and materials are less expensive than many other "hard armouring" techniques. The rock provides a large amount of aquatic habitat it's easily repaired. The fibrous roots of the chosen vegetation prevents washout of fines, stabilizes the native soil, anchors armour stone to the bank, and increases the lift-off resistance. The vegetation also improves drainage of the slope by removing soil moisture for its own use. Vegetated riprap has a more natural appearance, and is therefore more aesthetically pleasing, which is frequently a matter of great importance in high-visibility areas. The vegetation also supplies the river with carbon-based debris, which is integral to many aquatic food webs, and birds that catch fish or aquatic insects will be attracted by the increased perching space next to the stream. The brushlayering methods reach out over the water, and provide shade and organic debris to the aquatic system.</p> | <p>Vegetated riprap may be inappropriate if flow capacity is an issue, as bank vegetation can reduce flow capacity, especially when in full leaf along a narrow channel. In remote areas large rocks may be difficult to obtain and transport, which may greatly increase costs. Riprap may present a barrier to animals trying to access the stream.</p> |
| #38 Rolls (Coir) | <p>Durable with high tensile strength. Rolls and Mats accumulate sediment while plants grow and roots develop. Biodegradable. Can be combined with brushlayering to provide immediate shoreline or streambank protection.</p> | <p>Coir Rolls are relatively expensive. Technique should be implemented during the dormancy period of the cuttings used for brushlayering and staking.</p> |

Table C-5: Procedural BMPs (Planning Strategies) for Erosion and Sediment Control

| BMP Objective | Applications | | | | Comments | |
|--|--------------|----------------------|--------------------------|---------------------------|---|---|
| | Slopes | Ditches and Channels | Large Flat Surface Areas | Borrow and Stockpile Area | Advantages | Limitations |
| Minimize Exposed Soils | ✓ | ✓ | ✓ | ✓ | Decrease of disturbed soil area decreases erosion potential and decreases quantity of erosion and sediment control measures required thus decreasing costs | May require topsoiling/seeding completed areas before stripping of new areas |
| Observe Environmental Timing Restrictions | ✓ | ✓ | ✓ | ✓ | Minimizes possible negative impacts on fish and wildlife | May affect schedule of adjoining works |
| Maximize Work During Favourable Weather | ✓ | ✓ | ✓ | ✓ | Increasing work capacity in favourable conditions minimizes volume of work required in less desirable (wet) conditions, thus decreasing potential for erosion and sediment loss | May require additional resources to increase scale of production/construction |
| Install BMPs Early | ✓ | ✓ | ✓ | ✓ | Early installation of erosion and sediment control measures ensures sediment losses are minimized during construction | May cause difficulties with site access or traffic |
| Avoid Wet Weather Periods | ✓ | ✓ | ✓ | ✓ | Avoiding construction in wet weather periods minimizes erosion potential | Shutdowns may prolong/delay construction activities |
| Topsoil and Seed Early | ✓ | ✓ | ✓ | | Topsoiling and seeding as early as possible covers exposed soil and reduces erosion potential | |
| Surface Roughening (Slope Texturing) | ✓ | | ✓ | ✓ | Surface roughening reduces erosion: 12% for a dozer ripping on the contour, 52% for track walking up and down the slope, 54% for sheep's foot rolling, and 76% for imprinting | Equipment may need to be retasked at a slight increase in costs |
| Preserve and Use Existing Drainage Systems | ✓ | ✓ | ✓ | ✓ | Preserve existing drainage routes and vegetation | May affect scheduling of certain construction activities |
| Control Construction Traffic | | | | ✓ | Avoids over-trafficking sensitive areas or areas with increased disturbance | Forcing traffic into localized areas may increase disturbance in high-traffic areas |
| Signage | ✓ | ✓ | ✓ | ✓ | Clearly labelling sensitive zones or areas | Increased costs of signs |

Table C-5: Procedural BMPs (Planning Strategies) for Erosion and Sediment Control

| BMP Objective | Applications | | | | Comments | |
|---------------------------------------|--------------|----------------------|--------------------------|---------------------------|--|--|
| | Slopes | Ditches and Channels | Large Flat Surface Areas | Borrow and Stockpile Area | Advantages | Limitations |
| | | | | | not to be disturbed makes workers aware of where work cannot occur | |
| Scheduling of Work | ✓ | ✓ | ✓ | ✓ | Placement of topsoil and seeding should be scheduled throughout construction phase. New sections should not be stripped far in advance of construction | May require construction to be completed in one area before starting in another. |
| Stockpile Control | | | | ✓ | Stockpiles should be located well away from watercourses and environmentally sensitive areas | May result in longer haul distances. |
| Direct Surface Water Flow Around Site | ✓ | ✓ | ✓ | ✓ | Keeps surface water from off-site from increasing erosion | Diversion ditches may require erosion and sediment control measures to be implemented. |

| | |
|--------------------------------|-----------|
| Silt Fence Sediment Control | B.M.P. #1 |
|--------------------------------|-----------|

Description and Purpose

- Permeable fabric barriers installed vertically on support posts along contours to collect sediment laden sheet flow runoff
- Causes water to pond allowing sediment to settle out as water filters through fabric
- Entraps and minimizes coarse sediment from sheet flow or overland flow from entering waterbodies
- Perimeter control for sediment transport and deposition

Applications

- Temporary measure
- Used at bottom of cut or fill slopes to collect sediment laden runoff
- Used along streams (or channels) banks
- Used around stockpiles
- Midslope grade-break (using "J-hook" or "smile" pattern to effect ponding, filtering and sedimentation)

Advantages

- Low permeability silt fences have high filtering capabilities for fine sand to coarse silt
- Filter fence more effective than straw bales at filtering out sediment

Limitations

- Applicable for sheet flow, cannot handle concentrated channel flow volumes
- May fail under high runoff events
- Limit to locations suitable for temporary ponding of sediment laden runoff
- Low permeability silt fences may not be strong enough to support weight of water retained behind it and may require reinforcement (i.e., wire mesh and stronger support)
- Sediment build up needs to be removed on a regular basis
- Damage to fence may occur during sediment removal
- Useable life of approximately one year dependent on regular maintenance

| | |
|--------------------------------|-----------|
| Silt Fence Sediment Control | B.M.P. #1 |
|--------------------------------|-----------|

Construction

- Two methods of installation are commonly used
 - Trench method
 - Mechanical (slicing) installation method (e.g. Tommy Silt Fence Machine or equivalent)
- Trench Method
 - Select location of silt fence (usually along contours)
 - Drive support posts a minimum of 0.3 m into ground, spaced a maximum of 2 m apart
 - Excavate trench approximately 0.15 m deep by 0.15 m wide for entire length of fence along upstream side of posts
 - Attach the wire mesh or snow fencing, if used as reinforcement, to upstream side of posts with staples
 - Extend filter fabric to base of trench and attach over wire mesh or snow fence, if used, on upstream side of posts
 - Backfill and compact soil in trench, being careful not to damage fence
- Mechanical Installation Method
 - Select location of silt fence (usually along contours)
 - Use mechanical installation machine to embed the fabric a minimum of 0.15 m into the ground. One mechanical installation method is by slicing (with special equipment) the geotextile fabric embeds into the ground without excavation and backfill. There is only minor disturbance of the ground. Tamping of ground is required for compaction.
 - Drive support posts a minimum of 0.3 m into ground, spaced a maximum of 2 m apart
 - Attach the wire mesh or snow fencing, if used as reinforcement to silt fence fabric, to upstream side of posts with staples
 - Extend filter fabric to base of trench and attach over wire mesh or snow fence, if used, on upstream side of posts

Construction Considerations

- Site Selection

| | |
|---|------------------|
| <p>Silt Fence</p> <p>Sediment Control</p> | <p>B.M.P. #1</p> |
|---|------------------|

- Size of drainage area should be no greater than 0.1 ha per 30 m length of silt fence
- Maximum flow path length above silt fence should be no greater than 30 m
- Maximum slope gradient above the silt fence should be no greater than 2H:1V
- Fence should be placed on contour to produce proper ponding
- Fence should be placed far enough away from toe of slope to provide adequate ponding area (minimum of 1.8 m away from toe of slope is recommended)
- Ends of fence should be angled upslope to collect runoff
- Fence should not extend more than 0.6 m above grade
- Posts can be wood or metal material dependent on design and ground conditions
- Posts should be placed on downstream side of fence
- Posts should not be spaced greater than 2 m apart
- Wire mesh or standard snow fencing may be placed between the posts and fabric barrier to provide additional strength and support reinforcement
- Geotextile should be cut from a continuous roll to avoid joints (if joints are necessary, the wrapping of fabric around the fence post and a minimum overlap of 0.2 m with staples should be used to attach the fabric to the post)
- Fence (and wire mesh or snow fence, if used) should be attached to posts with heavy duty staples, tie wires, or hog rings
- Fence (and wire mesh or snow fence, if used) should be dug into a trench at least 0.15 m deep to prevent undercutting of fence by runoff
- Trench backfill should be compacted
- Long runs of silt fence are more prone to failure than short runs
 - Maximum length of each section of silt fence should be 40 m
 - Silt fence should be installed in 'J' hook or 'smile' configuration, with maximum length of 40 m, along contours allowing an escape path for ponded water (minimizes overtopping of silt fence structure)

Inspection and Maintenance

- Inspection frequency should be in accordance with the PESC and TESC Plans
- Repair undercut fences and repair or replace split, torn, slumping or weathered fabric immediately

| | |
|--------------------------------|-----------|
| Silt Fence Sediment Control | B.M.P. #1 |
|--------------------------------|-----------|

- Sediment build up should be removed once it accumulates to a depth of 0.2 m
- Remove fence after vegetation is established
- Deactivate fabric by cutting-off top portion of fabric above ground; bottom trenched-in portion of fence fabric can be left in-ground thus minimizing ground disturbance

Similar Measures

- Straw Bales
- Rock Barrier
- Permeable/Synthetic Barriers

Design Considerations

- For a silt fence system to work as a system, the following factors should be considered:
 - a) quantity – adequate number and frequency of fence for efficient ponding and sedimentation
 - b) installation – workmanship
 - c) compaction – backfill and trenching of fabric
 - d) support – posts adequately embedded, appropriate selection of post material and spacing
 - e) attachment – secure fabric to post
- Install silt fences in a 'J' hook or 'smile' configuration

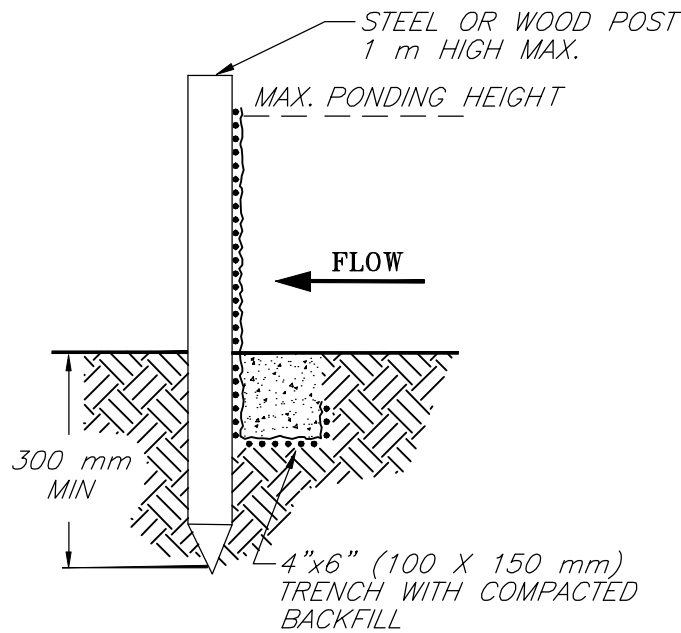
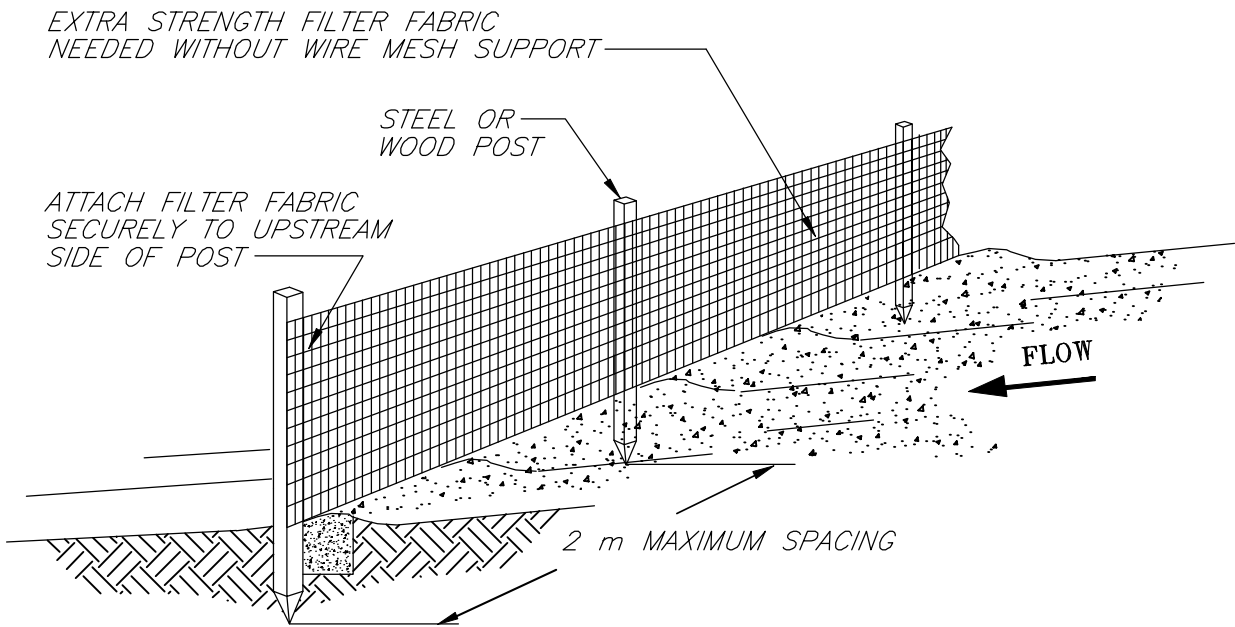

TRENCH METHOD DETAIL

NOTES:

1. SILT FENCE SHALL BE PLACED ON SLOPE CONTOURS TO MAXIMIZE PONDING EFFICIENCY.
2. INSPECT AND REPAIR FENCE DAILY AND AFTER EACH STORM EVENT AND REMOVE SEDIMENT WHEN ACCUMULATED SILT REACHES 200 mm.
3. REMOVED SEDIMENT SHALL BE DEPOSITED TO AN AREA WILL NOT CONTRIBUTE SEDIMENT OFF-SITE.
4. THIS FIGURE IS PROVIDED FOR GUIDANCE ONLY AND DOES NOT CONSTITUTE A DESIGN. A SITE SPECIFIC DESIGN IS REQUIRED FROM DESIGNER/ENGINEER.

NOT TO SCALE

**SILT FENCE
(TRENCH METHOD)**

FILE: SILTFENC

© 1994 JOHN McCULLAH
From: Salix—Applied Earthcare — EROSION DRAW 3.0

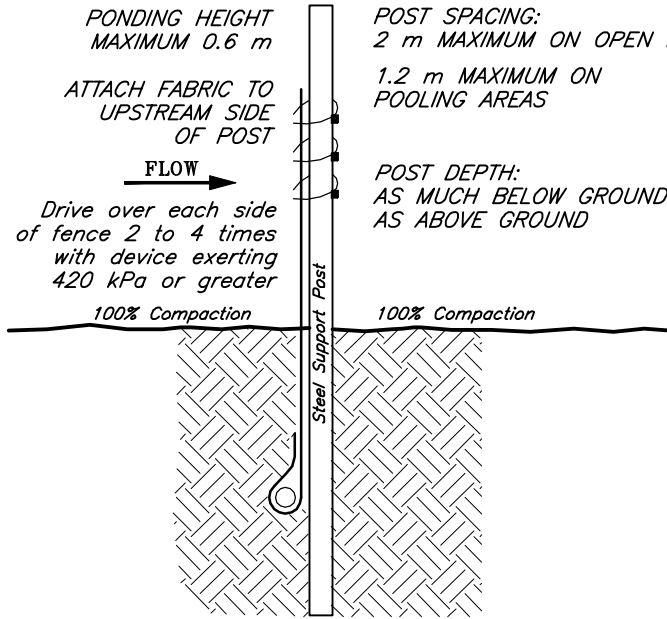

POST SPACING:
2 m MAXIMUM ON OPEN RUNS
1.2 m MAXIMUM ON
POOLING AREAS

POST DEPTH:
AS MUCH BELOW GROUND
AS ABOVE GROUND

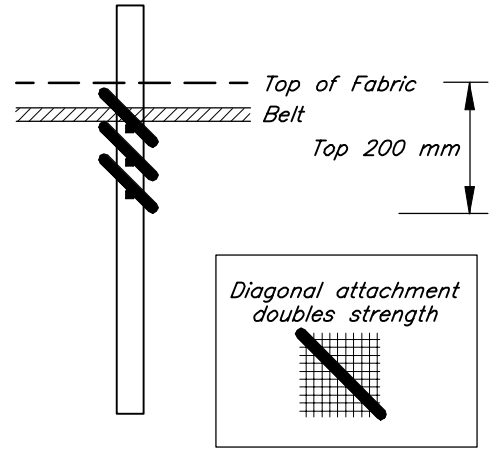

ATTACHMENT DETAILS:

- Gather fabric at posts, if needed.
- Utilize three ties per post, all within top 200 mm of fabric.
- Position each tie diagonally, puncturing holes vertically a minimum of 25 mm apart.
- Hang each tie on a post nipple and tighten securely.
- Use cable ties (50 lbs) or soft wire.

NO MORE THAN 0.6 m OF A 0.9 m FABRIC IS ALLOWED ABOVE GROUND

MECHANICAL (SLICING) METHOD

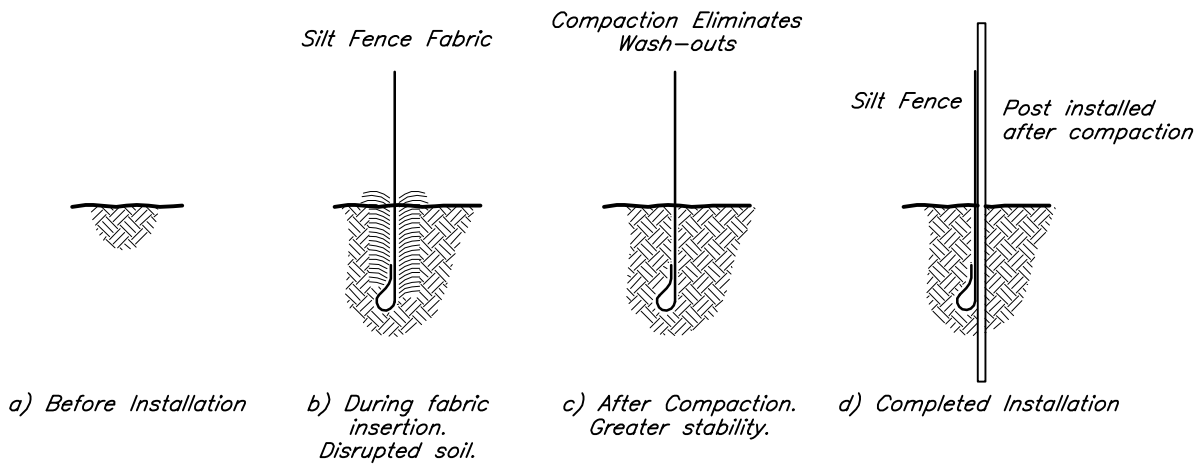

MECHANICAL (SLICING) METHOD INSTALLATION SEQUENCE

NOTES:

1. INSTALLATION MACHINE MUST ALLOW CONTINUOUS SLICING AND EMBEDMENT OF GEOTEXTILE INTO GROUND WITH MINOR GROUND DISTURBANCE.
2. INSTALLATION MACHINE TYPES WILL VARY WITH MANUFACTURER.
3. THIS FIGURE IS PROVIDED FOR GUIDANCE ONLY AND DOES NOT CONSTITUTE A DESIGN. A SITE SPECIFIC DESIGN IS REQUIRED FROM DESIGNER/ENGINEER.

NOT TO SCALE

SILT FENCE
(MECHANICAL METHOD)

SOURCE: CARPENTER T. 2000

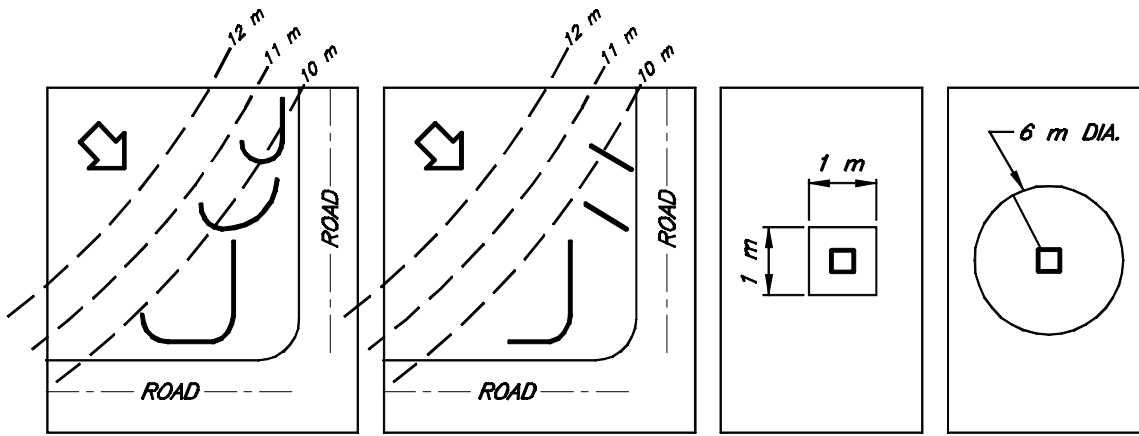

CORRECT

INCORRECT

"J" CONFIGURATION

SILT FENCE BARRIER AT STORM INLET

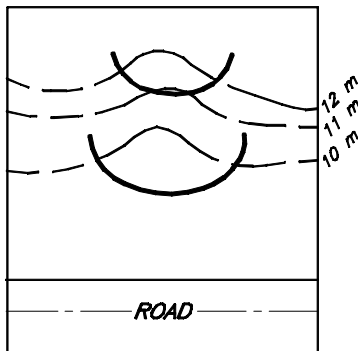

"SMILE" CONFIGURATION

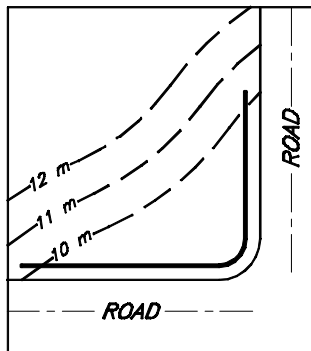

AVOID LONG INSTALLATION

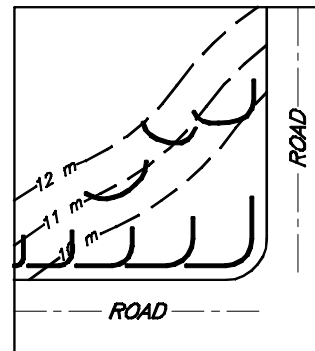

COMBINATION OF "SMILE" AND "J" CONFIGURATIONS

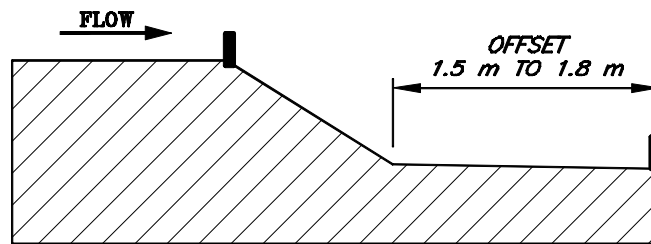

LOCATION AT TOP AND BOTTOM OF SLOPE

NOT TO SCALE

NOTE:

1. THIS FIGURE IS PROVIDED FOR GUIDANCE ONLY AND DOES NOT CONSTITUTE A DESIGN. A SITE SPECIFIC DESIGN IS REQUIRED FROM DESIGNER/ENGINEER.

SOURCE: CARPENTER T. 2000

**SILT FENCE
(CONFIGURATION PLAN)**

| | |
|--|----------------------------|
| <p>Gabions (a - c)</p> <p>Erosion Control and Sediment Control</p> | <p>B.M.P. #2 (a-c)</p> |
|--|----------------------------|

Description and Purpose

- Consist of rock placed inside wire baskets to protect steep or erodible slopes from sheet flow erosion
 - Protects erodible stream channel banks from potentially high erosive concentrated flow velocities or high tractive forces
- a) Slope and Banks
 - b) Single Gabion Drop Structure for Ditch Channel
 - c) Double Gabion "Energy Dissipator" Drop Structure for Ditch Channel

Applications

- Permanent measure
- May be used on stream bank aprons and blankets where flow velocities do not exceed 6 m/s
- May be constructed to 0.5H:1V as a low height slope toe protection structure
- May be used on slopes up to 1.5H:1V as slope protection, a grade break and flow check
- Gabion matting is an alternative to riprap armouring of channels
- May be used to construct dikes or weirs
- Used as a drop structure (check structure) to reduce grade between structures and as flow check in channels
- Used as a splash pad to slow down flow velocity and dissipate flow energy

Advantages

- Relatively maintenance free
- Long lasting and sturdy structure
- Lower thickness requirement for gabion (can be 1/2 to 1/3 riprap thickness) compared with riprap thickness for identical severe hydraulic conditions.
- Allows smaller diameter rock material to be used where it would normally be erodible with riprap placement
- Gabions are porous, free-draining and flexible so they are less affected by frost heaving and hydrostatic pressures

| | |
|--|----------------------------|
| <p>Gabions (a - c)</p> <p>Erosion Control and Sediment Control</p> | <p>B.M.P. #2 (a-c)</p> |
|--|----------------------------|

- Trap sediment and support plant growth to effect higher channel resistance to flow; however, cumulative build-up of silt may render gabions less effective with diminished height

Limitations

- Construction is labour intensive
- Extra costs associated with wire for mesh cages and rock fill plus geotextile fabric or sand filter layer

Construction

- Prepare subgrade at designated gabion location on mineral soil
- Excavate trench a minimum of 0.15 m deep to 'key-in' gabion structure
- Construct gabion basket as per manufacturer's recommendations
- Line interior of basket with non-woven geotextile OR a gravelly sand filter layer (if required by design) along areas where the basket is in contact with soil
 - Geotextile must be non-woven fabric to act as a separator (filter) between rock-infill and subgrade soils to minimize infiltration of fine grained particles into the gabion structure
- Backfill basket with rock with wire bracing at 1/3 points (or 0.3 m spacings)
- Install gabion basket top
- Backfill trench and compact soil around edges of completed basket

Construction Considerations

- Gabions should be placed on a properly graded surface
- Non-woven geotextile should be used to prevent loss of underlying material and infiltration of fine grained particles into the gabion structure
- Rock in the baskets may be placed by hand to enhance dense packing of stones and decrease void spaces
- Construct gabions with internal wire diaphragms to maintain structural stability and shape

Inspection and Maintenance

- Inspection frequency should be in accordance with the PESC and TESC Plans and should be inspected after major storm events, especially where undermining at the toe of the gabion is a concern

| | |
|---|--------------------|
| Gabions (a - c) Erosion Control and Sediment Control | B.M.P. #2 (a-c) |
|---|--------------------|

- Repair as necessary; repair may include hand grading and/or infilling undermined area with rocky material
- Removal of silt should be determined based on depth of siltation, channel erosion and establishment of vegetation

Similar Measures

- Berms/Barriers
- Check Dams
- Permeable/Synthetic Barriers
- Rock/Brush barriers
- Sand/Gravel Bag Barriers

Design Considerations

- The design should include an energy dissipator (i.e., a gabion mat as a splash pad) at toe of downstream side of gabion drop structure if overtopping of the gabion is anticipated

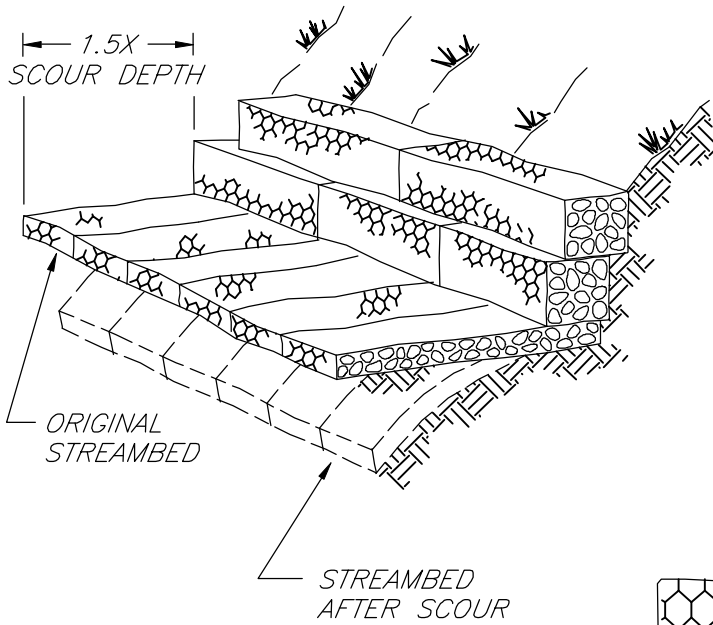

TYPICAL GABION APRON

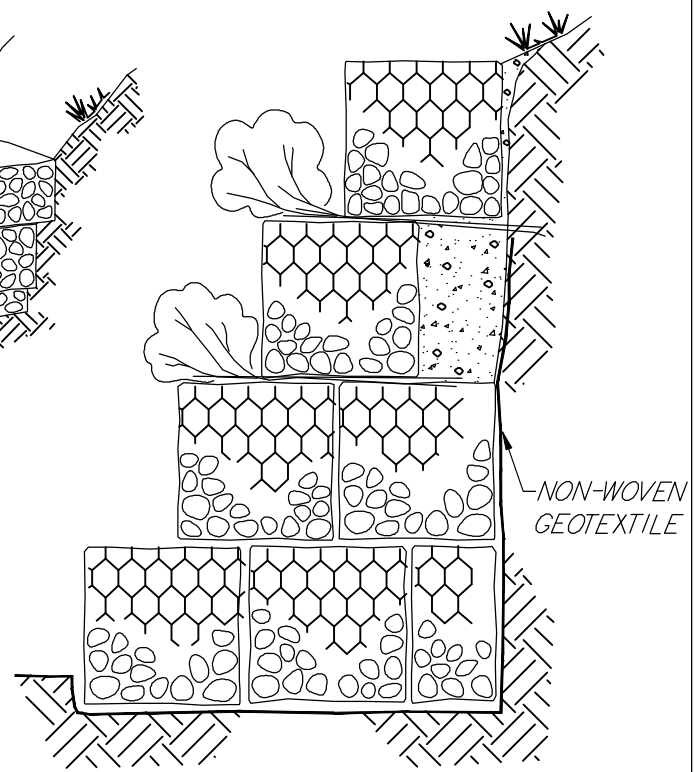

TYPICAL VEGETATED ROCK GABION

TYPICAL GABION AND GABION MATTRESS

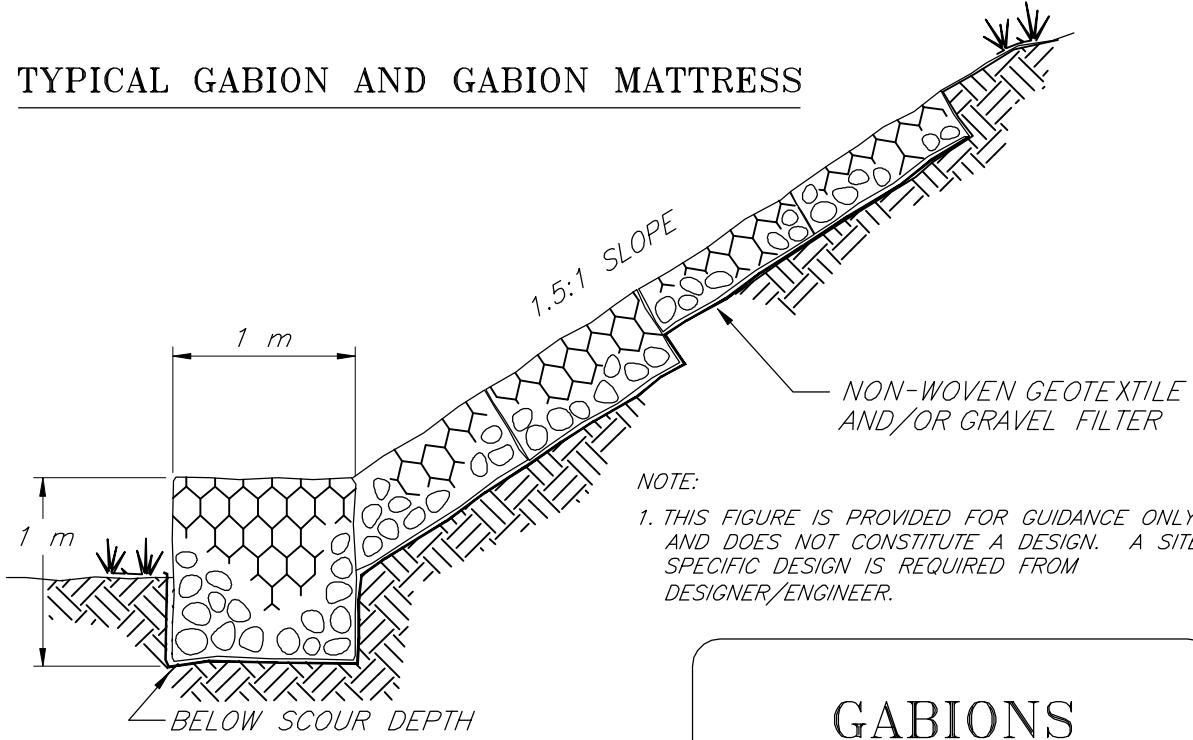

**GABIONS
(SLOPE AND BANK)**

From: Salix-Applied Earthcare - EROSION DRAW 3.0
1996 JOHN McCULLAH

© FILE: GABIONS

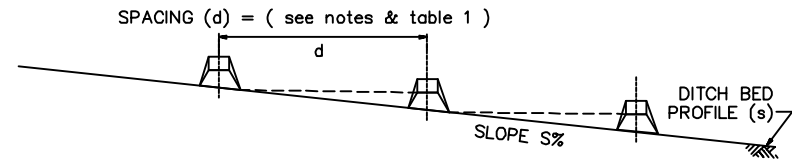
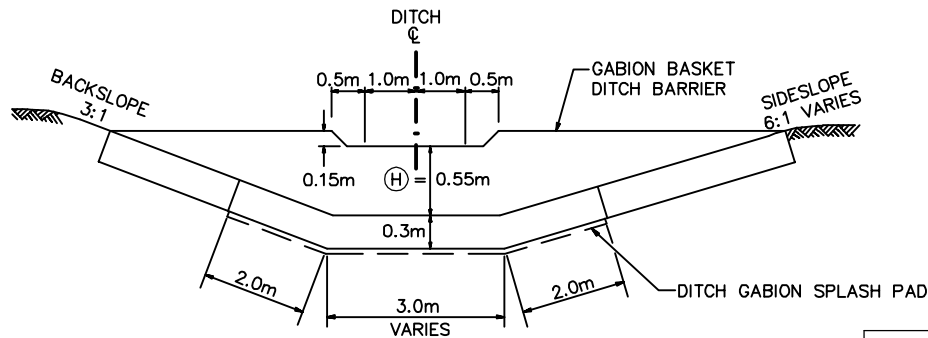

| SUGGESTED SPACING (d) | | REMARKS |
|-----------------------|-----|--|
| S (%) | (m) | |
| 5-7 | 30 | OPTION TO INSTALL A GRADE BREAK (s.a. WEAVE BARRIER) BETWEEN STRUCTURES. |
| 7-8 | 25 | A DOUBLE GABION FOLLOWS EVERY 2 SINGLE GABIONS. |
| >8% | ≤15 | DESIGN BY ENGINEER REQUIRED. |

TABLE 1

NOTES:

- SUITABLE FOR MEDIUM TO STEEP GRADES AND CHANNELS LEADING TO WATER COURSE $4\% < S < 10\%$.
- i) SPACING TO BE DETERMINED BY ENGINEER BASED ON HYDRAULIC CONDITIONS.
ii) USE IN CONJUNCTION WITH DOUBLE GABIONS OR OTHER BARRIER STRUCTURES.
- SOIL COVERING BETWEEN STRUCTURES SUGGESTED FOR STEEP GRADE SOIL DITCH.
- THIS FIGURE IS PROVIDED FOR GUIDANCE ONLY AND DOES NOT CONSTITUTE A DESIGN. A SITE SPECIFIC DESIGN IS REQUIRED FROM DESIGNER/ENGINEER.

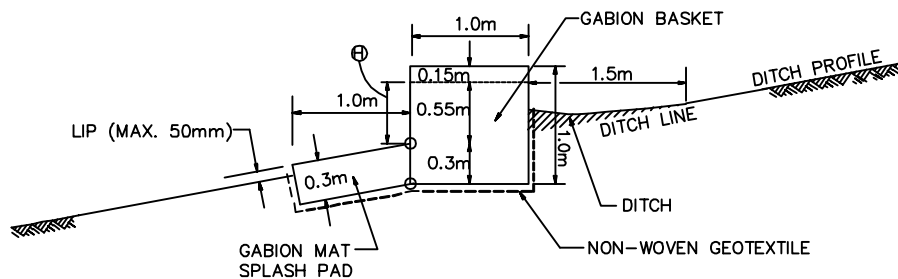

**GABIONS
SINGLE GABION
DROP STRUCTURE FOR
DITCH CHANNEL**

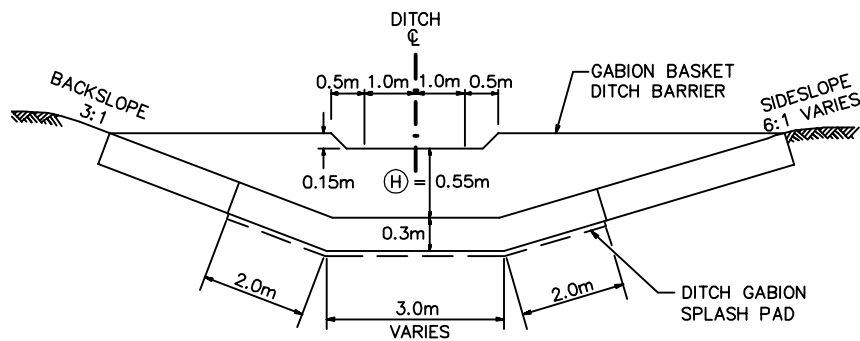

FRONT VIEW FROM DOWNSTREAM
TYPICAL DITCH CROSS-SECTION
GABION BASKET DITCH BARRIER
N.T.S.

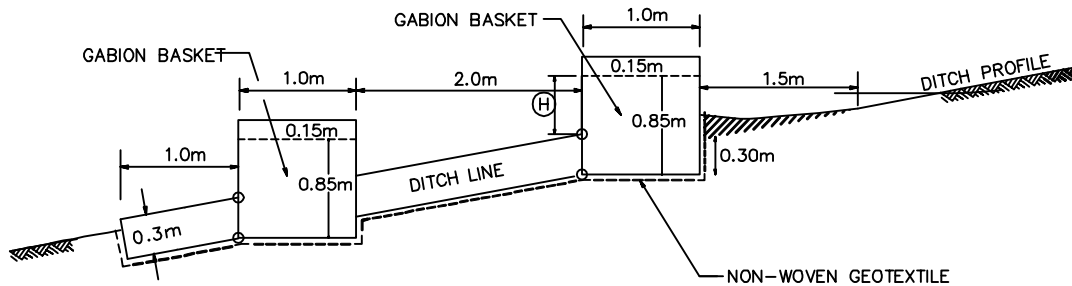

CROSS-SECTION VIEW
"DOUBLE GABION" ENERGY DISSIPATION GABION STRUCTURE
(TWO SINGLE GABIONS COMBINED)
N.T.S.

SPACING (d) = (see table 1 and notes)

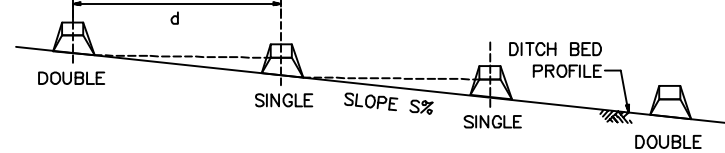

TYPICAL BARRIER SPACING
N.T.S.

| SUGGESTED SPACING (d) | | REMARKS |
|-----------------------|-----|---|
| S (%) | (m) | |
| 6-8 | 25 | INTER-SPACED WITH 2 SINGLE GABIONS BETWEEN STRUCTURES *SEE NOTES |
| | 35* | |
| >8% | ≤15 | DESIGN BY ENGINEER REQUIRED |

TABLE 1

NOTES:

- SUITABLE FOR STEEP GRADES (6%<S<12%) AND CHANNELS LEADING TO WATER COURSE
- i) SPACING (d) TO BE DETERMINED BY ENGINEER BASED ON HYDRAULIC CONDITIONS.
ii) USE IN CONJUNCTION WITH SINGLE GABION AND/OR OTHER GRADE BREAK STRUCTURES.
- SUGGESTED TWO SINGLE GABIONS AT INTERVAL BETWEEN DOUBLE GABIONS.
- SOIL COVERING BETWEEN STRUCTURES SUGGESTED FOR STEEP GRADE SOIL DITCH.
- IF d* = 35 m at 7 to 8% GRADE
 - GRADE BREAK (s.a. PERMEABLE WEAVE BARRIER) SHOULD BE PLACED BETWEEN STRUCTURES.
 - LONG SPACING ALLOWABLE WHEN HYDRAULIC CONDITIONS NOT SEVERE.
- THIS FIGURE IS PROVIDED FOR GUIDANCE ONLY AND DOES NOT CONSTITUTE A DESIGN. A SITE SPECIFIC DESIGN IS REQUIRED FROM DESIGNER/ENGINEER.

**GABIONS
DOUBLE GABION
"ENERGY DISSIPATOR"
DROP STRUCTURE
FOR DITCH CHANNEL**

| | |
|--------------------------------------|-----------|
| Brush or Rock Filter Berm Removed | B.M.P. #3 |
|--------------------------------------|-----------|

Description and Purpose

- Constructed of sand or gravel-filled geotextile, or formed structures comprised of compost, shredded wood mulch, and natural fibres
- Used to divert and intercept sheet or overland flow
- May be used to form ponds and allow sediment to settle out
- Compost should possess no objectionable odours or substances toxic to plants
- Compost contains plant nutrients but is typically not characterized as a fertilizer

Applications

- Temporary measure
- May be used in place of silt fences or straw bale barriers to retain sediment on construction sites
- Compost used on AT projects must meet Canadian Council of Ministers of the Environment (CCME) Guidelines for Compost Quality (trace elements, maturity/stability, pathogens), which are adopted by Alberta Transportation and found on AT Products List (www.transportation.alberta.ca).
- May be used in place of silt fences or straw bale barriers to retain sediment on construction sites

Advantages

- Trenching may not be required as weight and flexibility of structure typically allows continuous contact with ground surface

Limitations

- Sand or gravel filled geotextile requires Continuous Structure Machine (CBM) for construction
- Requires specialized blower truck, hose and attachments for berm installation

Construction

- Install structure a minimum of 2 m away from toe of slope to provide adequate ponding area on upstream side of structure
- Follow operating procedures for CBM
- Use of woven geotextile is preferred due to higher tensile strength and small deformation

Continuous Perimeter Control Structures

Sediment Control

B.M.P. #4

- If required, PVC drainage pipes (e.g., 50 mm) may be inserted in downstream side of structure, spaced 100 to 150 mm apart, to facilitate drainage
- If required and appropriate, slits may be cut in upstream side of structure to facilitate filtering and drainage

Compost filter berm installation:

- Parallel to the base of the slope, or around the perimeter of affected areas, construct a trapezoidal berm at the following dimensions:

| Annual Rainfall/Flow Rate | Total Precipitation | Berm Dimensions (height x width) |
|---------------------------|---------------------|----------------------------------|
| Low | 25 mm – 635 mm | 30 cm x 60 cm – 45 cm x 90 cm |
| Average | 635 mm – 1270 mm | 30 cm x 60 cm – 45 cm x 90 cm |
| High | >1270 mm | 45 cm x 90 cm – 60 cm x 120 cm |

- Base of berm is twice the height
- Compost shall be uniformly applied using an approved spreader unit - including pneumatic blowers, specialized berm machines, etc
- Seeding the berm may be done in conjunction with pneumatic blowing
- Compost can be blown into a netted sock to be used as a berm

Construction Considerations

- Structure constructed of sand, aggregate, or other pervious soil encased in geotextile fabric
- Maximum structure height is approximately 0.4 m
- Higher permeability fill materials should be used in 'drainage chambers' in low areas
- Compost filter berm dimensions and blanket application rates vary with soil characteristics, existing vegetation and climatic conditions
- Use larger berm application rate in high rates of precipitation and rainfall intensity, and snow melt
- Use larger berms in severe grade and long slope lengths
- Berms may be placed at the top and the base of a slope
- A series of berms may be used down a slope (5 to 8 m apart)
- Berms may be used in conjunction with a compost blanket, especially in regions with spring melt, and sites with severe grades and long slopes

Continuous Perimeter Control Structures

Sediment Control

B.M.P. #4

- Use smaller berm application rate in lower precipitation rates and rainfall intensity regions
- Use larger berms where they are required to be in place or function for more than one year

Inspection and Maintenance

- Inspection frequency should be in accordance with PESC and TESC Plans.
- Inspect for sediment accumulation and remove sediment when depths reach approximately one-third the structure height
- Inspect for toe undermining, weathered/deteriorated geotextile, and end runs and erosion of the filter and repair immediately
 - Damaged sections may be repaired by restapling or placing another section of continuous structure upstream of the damaged section to provide seal
- If the structure is encased in a geotextile fabric, removal of structure is accomplished by splitting the structure, spilling fill material and removing fabric
- Removal of berm is accomplished by splitting the berm and sock, spilling fill material and removing sock

Similar Measures

- Structures/Barriers
- Sand/Gravel Bag Barriers
- Silt Fence
- Compost Berm

| | |
|--------------------------------------|-----------|
| Berm Interceptor Sediment Control | B.M.P. #5 |
|--------------------------------------|-----------|

Description and Purpose

- Earth dyke barrier constructed of compacted soil to intercept and divert flow of runoff water away from erodible slopes, sensitive areas or water bodies
- A spillway outlet of erosion-resistant granular material constructed to allow exit of diverted water to less sensitive areas

Applications

- Temporary or permanent measure
- Used instead of, or in conjunction with, diversion ditches
- Perimeter control
- Placed along contours and/or at toe of slope to divert run-off from sensitive areas
- Used to divert water to sediment control structures

Advantages

- Easy to construct
- Can be converted to sedimentation/impoundment pond with the design of a permeable filter berm at the exit spillway area (see BMP #13)

Limitations

- Generally, earth dyke barriers can be 1 to 2 m in height. Design by a geotechnical engineer is required for barriers greater than 3 m in height in accordance with dam design guidelines and regulatory requirements. The consequences of failure will influence the level of design and construction requirements

Construction

- Construct barrier from bottom up by placing and compacting subsequent lifts of soil
- Degree of compaction of each lift to be specified by the design engineer based on consequences of failure

| | |
|--------------------------------------|-----------|
| Berm Interceptor Sediment Control | B.M.P. #5 |
|--------------------------------------|-----------|

Construction Considerations

- The barrier should be trapezoidal in cross-section
- Low barriers should have the slopes suited to the construction material used
 - 1.5H:1V for granular soils
 - 2H:1V or flatter for compacted mixed or fine grained soils
 - Slope should be flattened to a minimum of 3H:1V for uncompacted fine grained soils

Inspection and Maintenance

- The degree and extent of inspection and maintenance performed on a earth dyke barrier is directly related to the consequences of failure. An engineer experienced in embankment design and inspection may be required for design, inspection, design of remedial measures, and supervision of their implementation
- Inspection frequency should be in accordance with the PESC and TESC Plans
- Piping failures may be remedied by replacing saturated soils with drier compacted soil and/or by placement of geotextile over the failed area and placing a stabilizing toe berm constructed of granular materials
- Inspect for sediment accumulation and remove sediment when depths reach approximately one-half the barrier height
- Deactivate and remove barrier once slope soils have stabilized and return barrier location to an acceptable condition

Similar Measures

- Berms
- Sand/Gravel Bag Barriers

Design Considerations

- Geotechnical design required for barriers constructed of fine grained soils and greater than 3 m in height

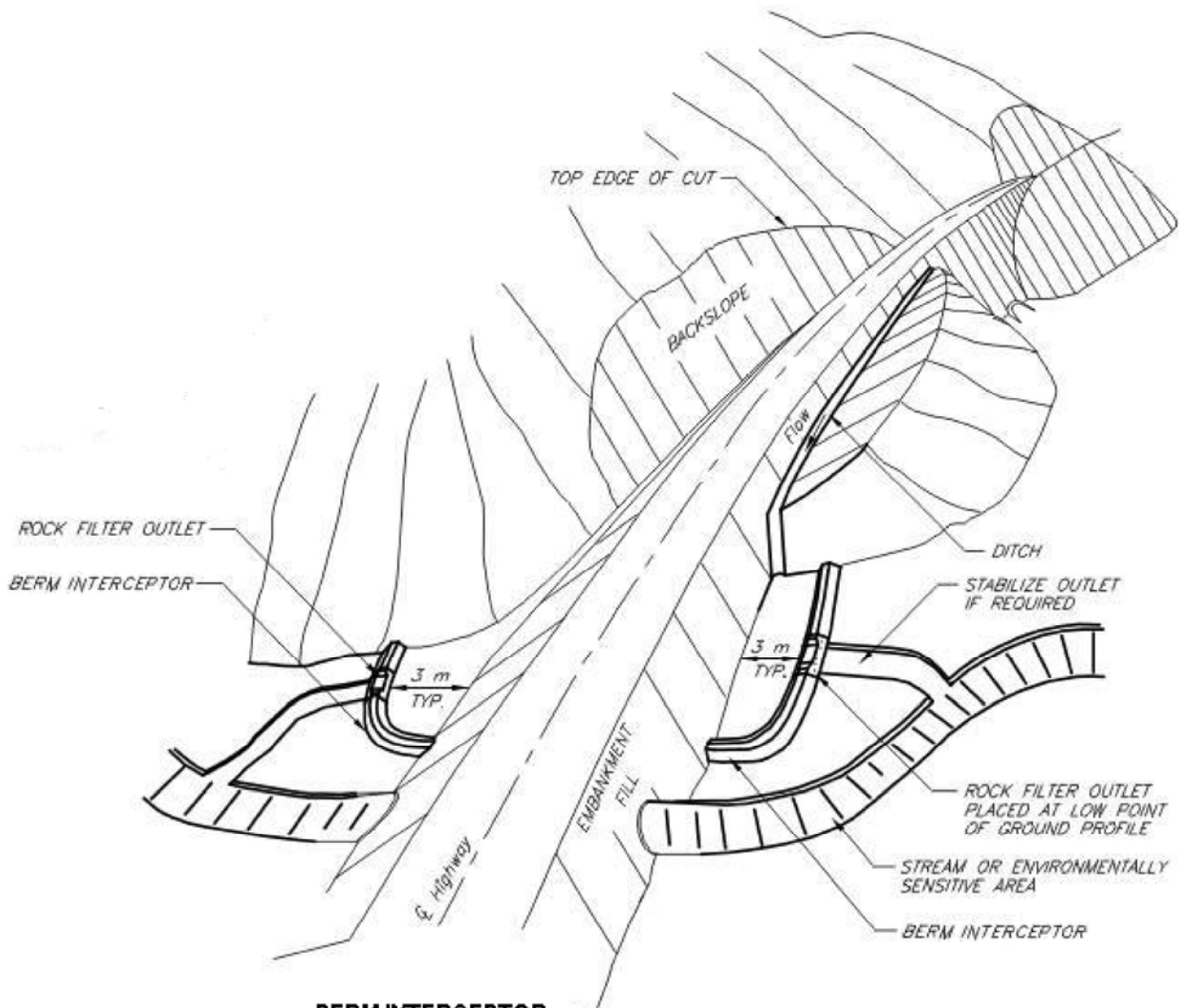

BERM INTERCEPTOR
TYPICAL LOCATION

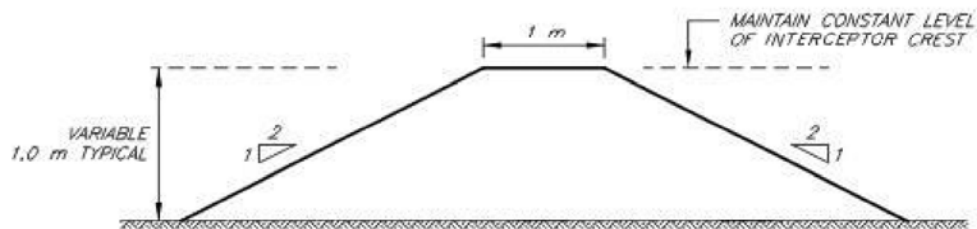

TYPICAL SECTION
BERM INTERCEPTOR

NOTES:

1. SILT ACCUMULATION TO BE REMOVED WHEN HALF BERM INTERCEPTOR HEIGHT COVERED.
2. THIS FIGURE IS PROVIDED FOR GUIDANCE ONLY AND DOES NOT CONSTITUTE A DESIGN. A SITE SPECIFIC DESIGN IS REQUIRED FROM DESIGNER/ENGINEER.

**BERM
INTERCEPTOR**

| | |
|---|----------------------------|
| <p>Storm Drain Inlet Sediment Barrier (a-f)</p> <p>Sediment Control</p> | <p>B.M.P. #6 (a-f)</p> |
|---|----------------------------|

Description and Purpose

- Temporary devices constructed to minimize the amount of sediment entering a storm drain by ponding sediment laden runoff at the inlet
- Storm Drain Inlet protection can consist of the following measures:
 - a) Block and Gravel Sediment Barrier – Option 1
 - b) Block and Gravel Curb Inlet Sediment Barrier – Option 2
 - c) Sand Bag Curb Inlet Sediment Barrier – Option 1
 - d) Sand Bag Curb and Gutter Sediment Barrier – Option 2
 - e) Straw Bale / Gravel Sediment Barrier - Option
 - f) Silt Fence Sediment Barrier - Option

Applications

- Temporary measure
- Used where storm drains are operational prior to establishing vegetation on disturbed drainage areas
- Can be effective where drainage enters municipal sewers or watercourses
- Used for small, nearly level (less than 5% grade) drainage areas
- Used as curb inlet barriers in gently sloping ditches and gutters
- Used where drainage area is 0.4 ha (1 ac) or less
- Used in open areas subjected to sheet flow and concentrated flows less than 0.014 m³/s (0.5 cfs)
- Block and gravel bag barriers are applicable when sheet flows or concentrated flows exceed 0.014 m³/s (0.5 cfs) and is necessary to allow for overtopping to prevent flooding
- Excavated drop inlet sediment traps are appropriate where relatively heavy flows are expected and overflow capacity is required

Advantages

- Easy to install and remove
- Sand bags may be reusable

Limitations

Storm Drain Inlet Sediment Barrier (a-f)

B.M.P. #6
(a-f)

Sediment Control

- Ponding around inlet may result in excessive local flooding
- Use only when ponding will not encroach into vehicular traffic, onto erodible surfaces and slopes or beyond the limits of the construction site
- Frequent removal of sediment required for high flow situations

Construction

- Place inlet sediment barrier around entrance to drain/pipe. The option appropriate for use is dependent on site conditions.
- Silt fence barrier can be used for soil surfaces
- Gravel or aggregate filled sand bags should be used for asphalt or concrete surfaces
- Aggregate filled sand bags
 - Place sand bags stacked one or two bags high around inlet
- Gravel barriers
 - Place concrete blocks stacked one or two blocks high, with cavities of blocks aligned with direction of flow, around inlet
 - Wrap 13 mm (1/2 inch) wire mesh around concrete blocks
 - Place 25 mm to 38 mm diameter rock around block and wire mesh assembly ensuring rock extends down from top of blocks to asphalt or concrete surfacing
- Gravel filter curb inlet
 - Place concrete blocks stacked one or two blocks high around inlet, with cavities of blocks aligned with direction of flow, forming a 'U' shape
 - Wrap 13 mm (1/2 inch) diameter wire mesh around concrete blocks
 - Place 25 mm to 38 mm diameter rock around block and wire mesh assembly ensuring rock extends down from top of blocks to asphalt or concrete surfacing

Construction Considerations

- Gravel or aggregate filled sand bags should be used for asphalt or concrete surfaces
- Aggregate filled sand bags
 - Sand bags should be filled with pea gravel, drain rock, or other free draining material

| | |
|---|----------------------------|
| <p>Storm Drain Inlet Sediment Barrier (a-f)</p> <p>Sediment Control</p> | <p>B.M.P. #6 (a-f)</p> |
|---|----------------------------|

- Gravel or aggregate filled sand bags should be filled only $\frac{3}{4}$ full to allow sand bag to be flexible to mould to contours, maintaining continuous contact with surface
- Barrier should be placed at least 0.1 m from inlet to be protected
- Several layers of sand bags should be overlapped and tightly packed against one another
- A one sand bag wide gap should be left in the lowest point of the upper layer to act as an emergency spillway
- Gravel filter inlet berm and gravel filter curb inlet
 - Slope gravel towards inlet at a maximum slope of 2H:1V
 - Maintain at least 0.3 m spacing between toe of gravel and inlet to minimize gravel entering inlet
 - 25 mm wire mesh may be placed over inlet to prevent gravel from entering inlet
- For drainage areas larger than 0.4 ha (1 ac) runoff should be directed towards a sediment retention device designed for larger flows before allowing water to reach inlet protection structure
- Use aggregate sand bags filled with 25 mm diameter rock in place of concrete blocks for gravel filter inlet berm or gravel filter curb inlet

Inspection and Maintenance

- Inspection frequency should be in accordance with the PESC and TESC Plans
- Remove sediment build up after each storm event
 - Sediment and gravel should not be allowed to accumulate on roads
- Replace gravel if it becomes clogged with sediment
- Remove all inlet protection devices when inlet protection is no longer required

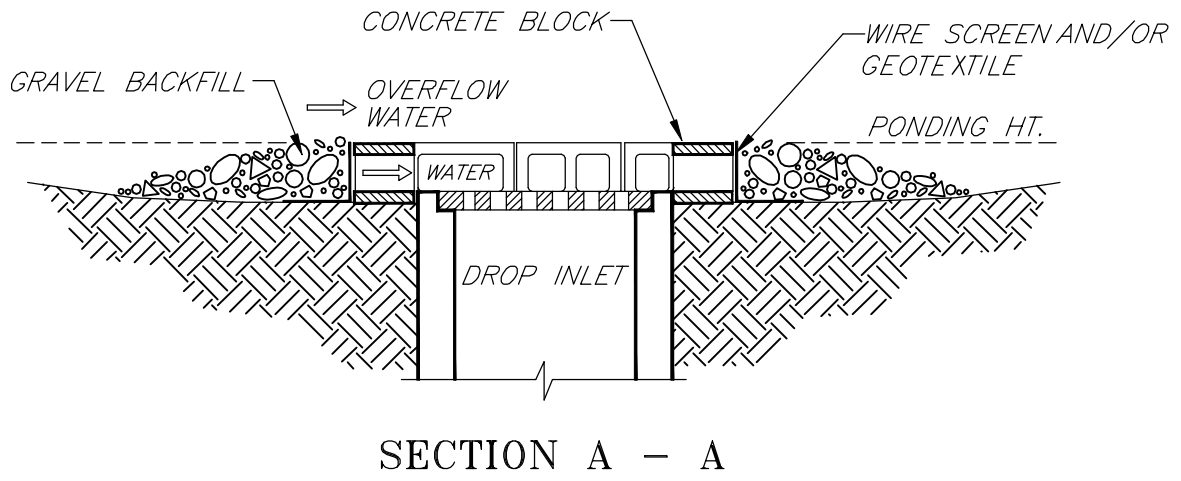
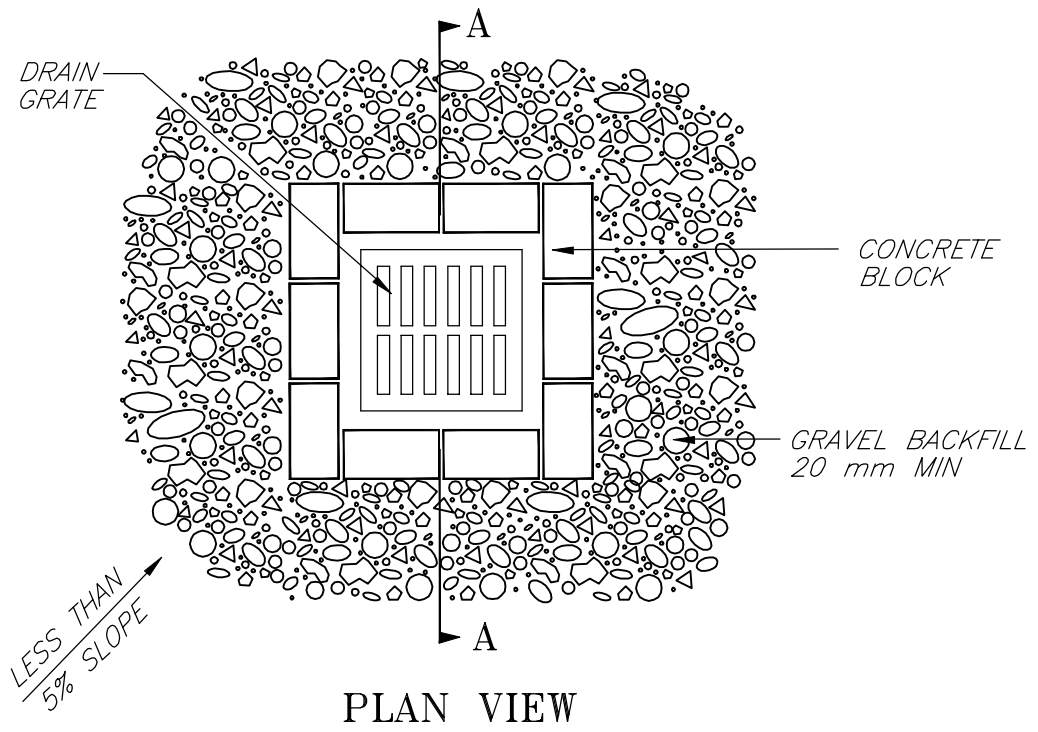

NOTES:

1. STORM DRAIN DROP INLET SEDIMENT BARRIERS ARE TO BE USED FOR SMALL, NEARLY LEVEL DRAINAGE AREAS. (LESS THAN 5%).
2. EXCAVATE A BASIN OF SUFFICIENT SIZE ADJACENT TO THE STORM DRAIN DROP INLET.
3. THE TOP OF THE STRUCTURE (PONDING HEIGHT) MUST BE WELL BELOW THE GROUND ELEVATION DOWNSLOPE TO PREVENT RUNOFF FROM BYPASSING THE INLET. A TEMPORARY DYKE MAY BE NECESSARY ON THE DOWNSLOPE SIDE OF THE STRUCTURE.
4. THIS FIGURE IS PROVIDED FOR GUIDANCE ONLY AND DOES NOT CONSTITUTE A DESIGN. A SITE SPECIFIC DESIGN IS REQUIRED FROM DESIGNER/ENGINEER.

**STORM DRAIN DROP INLET
SEDIMENT BARRIER
(BLOCK AND GRAVEL - OPTION 1)**

From: Salix-Applied Earthcare - EROSION DRAW 3.0
1994 JOHN McCULLAH



FILE: BGSDBAR

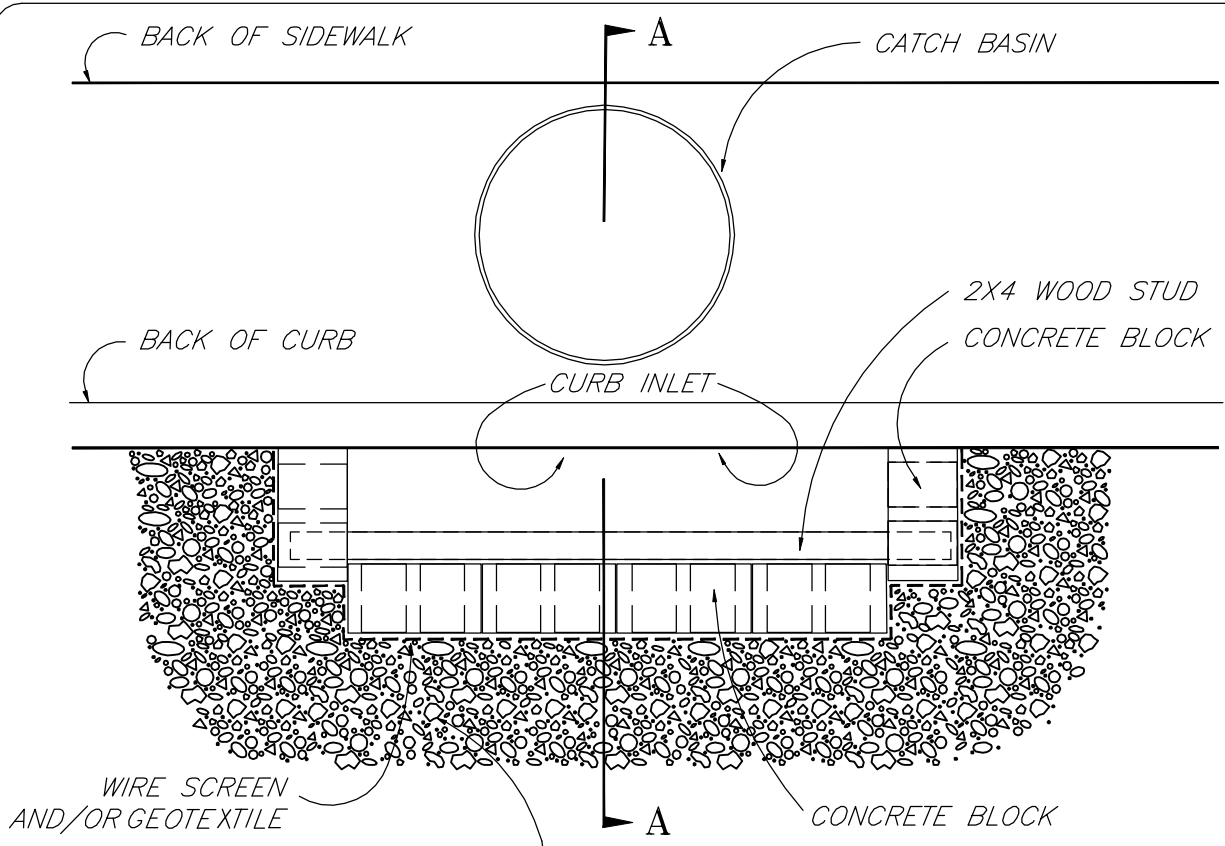

PLAN VIEW

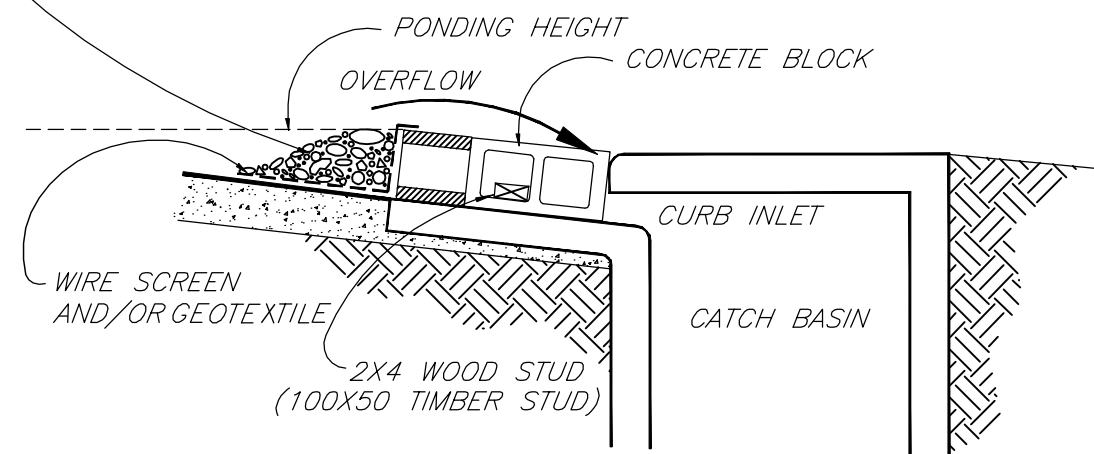

SECTION A - A

NOTES:

1. USE BLOCK AND GRAVEL TYPE SEDIMENT BARRIER WHEN CURB INLET IS LOCATED IN GENTLY SLOPING STREET SEGMENT, WHERE WATER CAN POND AND ALLOW SEDIMENT TO SEPARATE FROM RUNOFF.
2. BARRIER SHALL ALLOW FOR OVERFLOW FROM SEVERE STORM EVENT.
3. INSPECT BARRIERS AND REMOVE SEDIMENT AFTER EACH STORM EVENT. SEDIMENT AND GRAVEL MUST BE REMOVED FROM THE TRAVELED WAY IMMEDIATELY.
4. THIS FIGURE IS PROVIDED FOR GUIDANCE ONLY AND DOES NOT CONSTITUTE A DESIGN. A SITE SPECIFIC DESIGN IS REQUIRED FROM DESIGNER/ENGINEER.

**STORM DRAIN CURB INLET
SEDIMENT BARRIER
(BLOCK AND GRAVEL - OPTION 2)**

From: Salix-Applied Earthcare - EROSION DRAW 3.0
 1994 JOHN McCULLAH
 ©

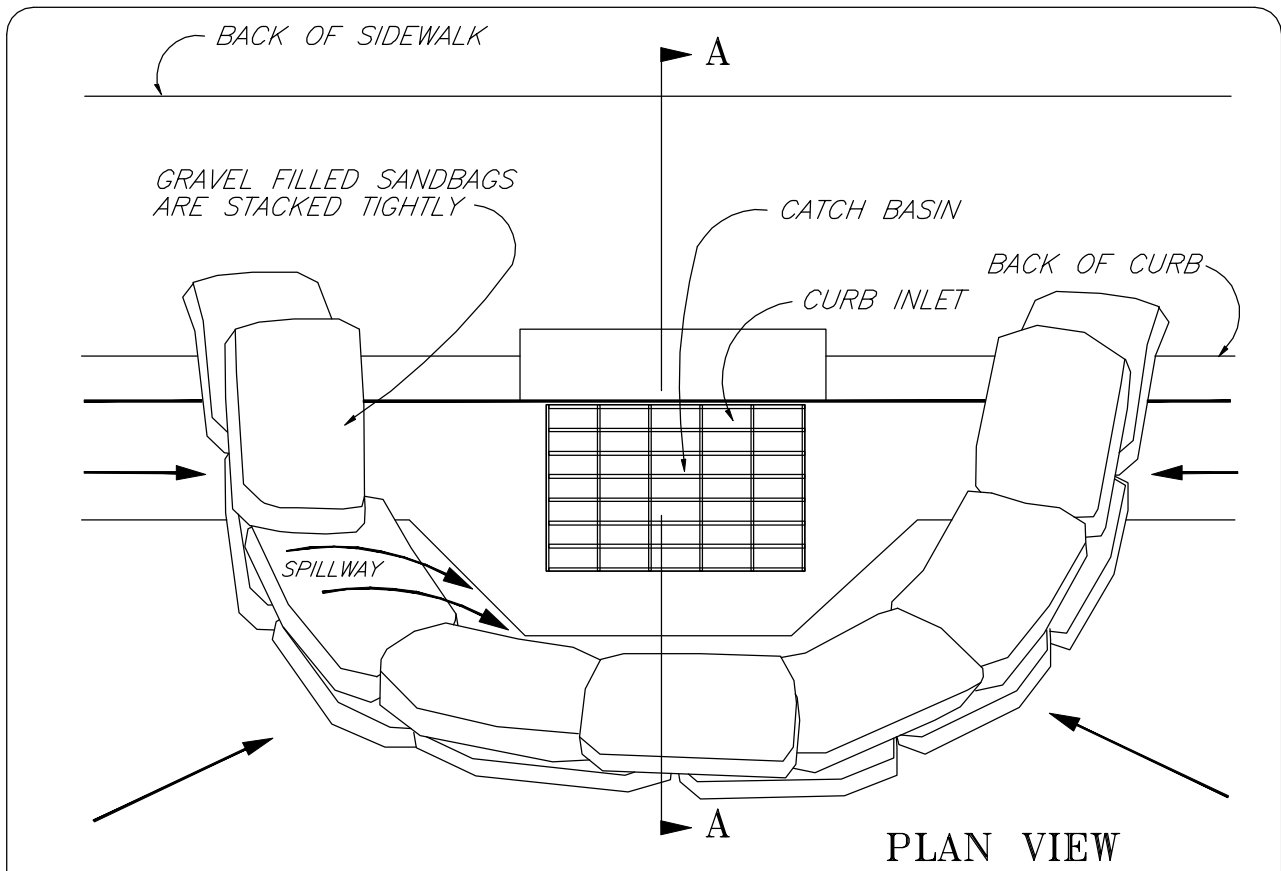

PLAN VIEW

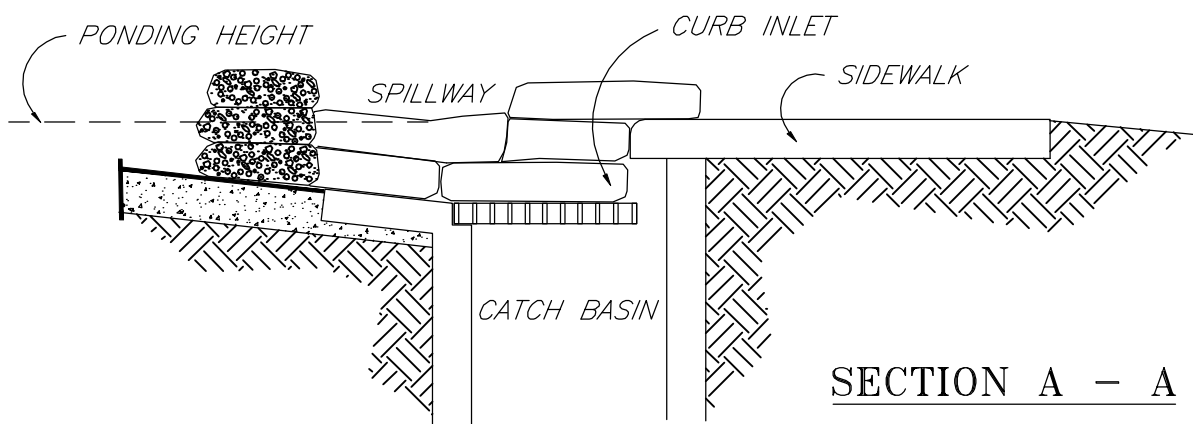

SECTION A - A

- NOTES:**
1. PLACE CURB TYPE SEDIMENT BARRIERS ON GENTLY SLOPING STREET SEGMENTS WHERE WATER CAN POND AND ALLOW SEDIMENT TO SETTLE OUT.
 2. SANDBAGS, OF EITHER BURLAP OR WOVEN GEOTEXTILE FABRIC, ARE FILLED WITH GRAVEL, LAYERED AND PACKED TIGHTLY.
 3. LEAVE ONE SANDBAG GAP IN THE TOP ROW TO PROVIDE A SPILLWAY FOR OVERFLOW.
 4. INSPECT BARRIERS AND REMOVE SEDIMENT AFTER EACH STORM EVENT. SEDIMENT AND GRAVEL MUST BE REMOVED FROM THE TRAVELED WAY IMMEDIATELY.
 5. THIS FIGURE IS PROVIDED FOR GUIDANCE ONLY AND DOES NOT CONSTITUTE A DESIGN. A SITE SPECIFIC DESIGN IS REQUIRED FROM DESIGNER/ENGINEER.

**STORM DRAIN CURB INLET
SEDIMENT BARRIER
(SANDBAGS - OPTION 1)**

From: Salix-Applied Earthcare - EROSION DRAW 3.0
 1994 JOHN McCULLAH
 ©

FILE: SANDCURB

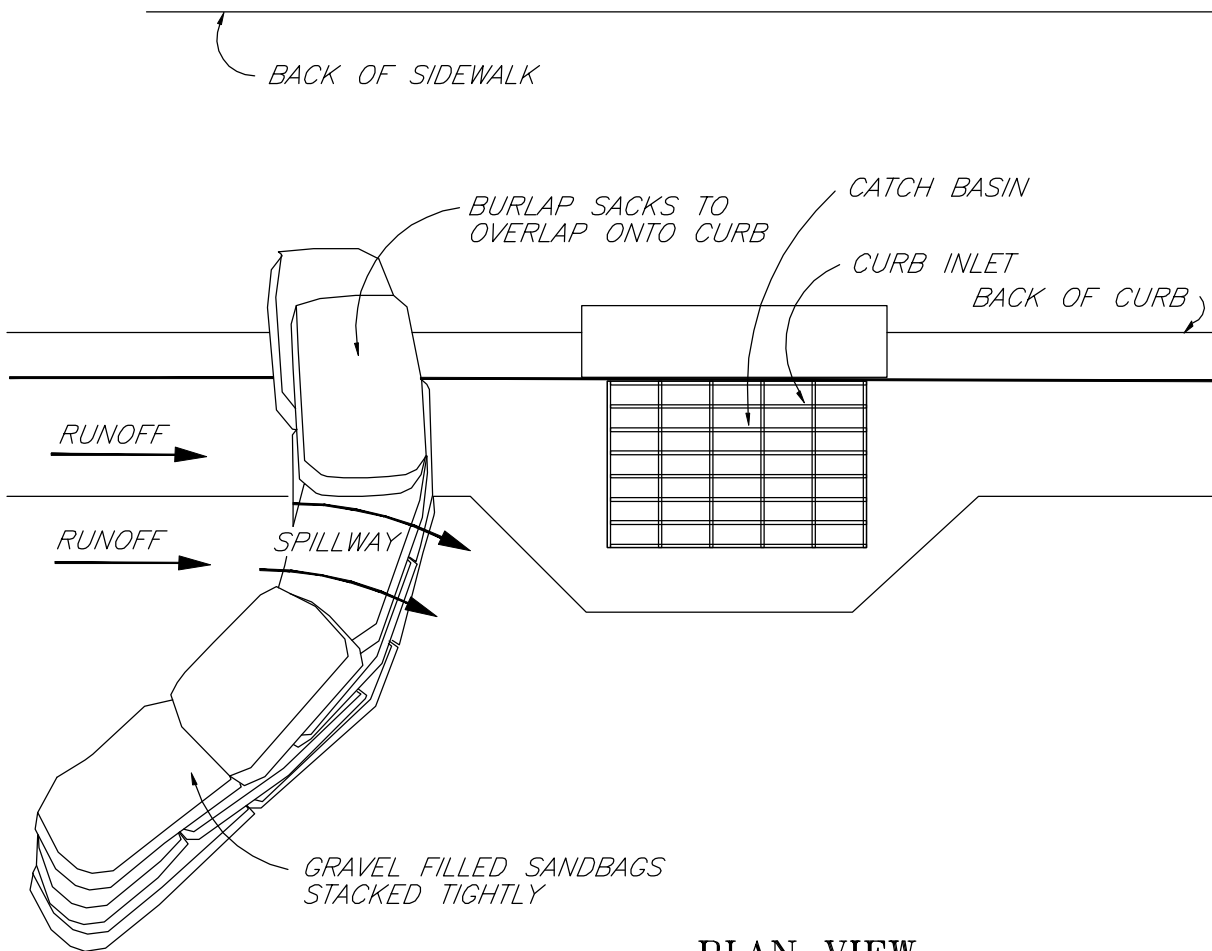

PLAN VIEW

NOTES:

1. PLACE CURB TYPE SEDIMENT BARRIERS ON GENTLY SLOPING STREET SEGMENTS, WHERE WATER CAN POND AND ALLOW SEDIMENT TO SETTLE OUT.
2. SANDBAGS OF EITHER BURLAP OR WOVEN 'GEOTEXTILE' FABRIC, ARE FILLED WITH GRAVEL, LAYERED AND PACKED TIGHTLY.
3. LEAVE A ONE SANDBAG GAP IN THE TOP ROW TO PROVIDE A SPILLWAY FOR OVERFLOW.
4. INSPECT BARRIERS AND REMOVE SEDIMENT AFTER EACH STORM EVENT. SEDIMENT AND GRAVEL MUST BE REMOVED FROM THE TRAVELED WAY IMMEDIATELY.
5. DESIGN CENTRE SPILLWAY LOWER THAN OUTSIDE EDGE TO MINIMIZE FLOW OUTFLANGING.
6. THIS FIGURE IS PROVIDED FOR GUIDANCE ONLY AND DOES NOT CONSTITUTE A DESIGN. A SITE SPECIFIC DESIGN IS REQUIRED FROM DESIGNER/ENGINEER.

**STORM DRAIN INLET
CURB AND GUTTER
SEDIMENT BARRIER
(SANDBAGS - OPTION 2)**

From: Salix-Applied Earthcare - EROSION DRAW 3.0
1994 JOHN McCULLAH



FILE: CURBGTR

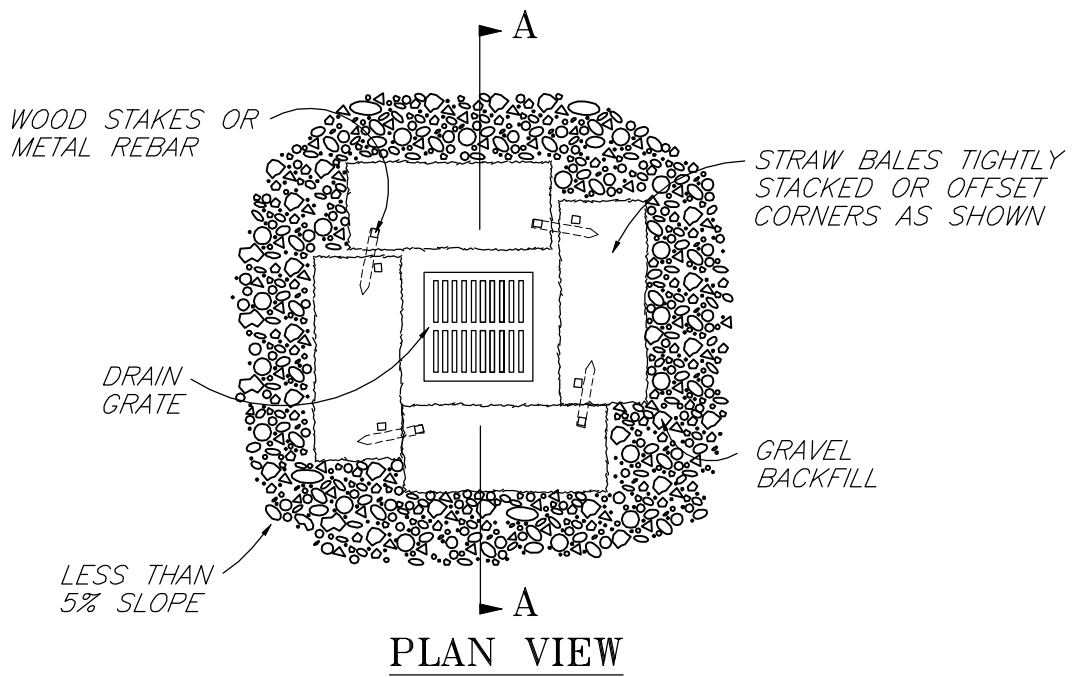

PLAN VIEW

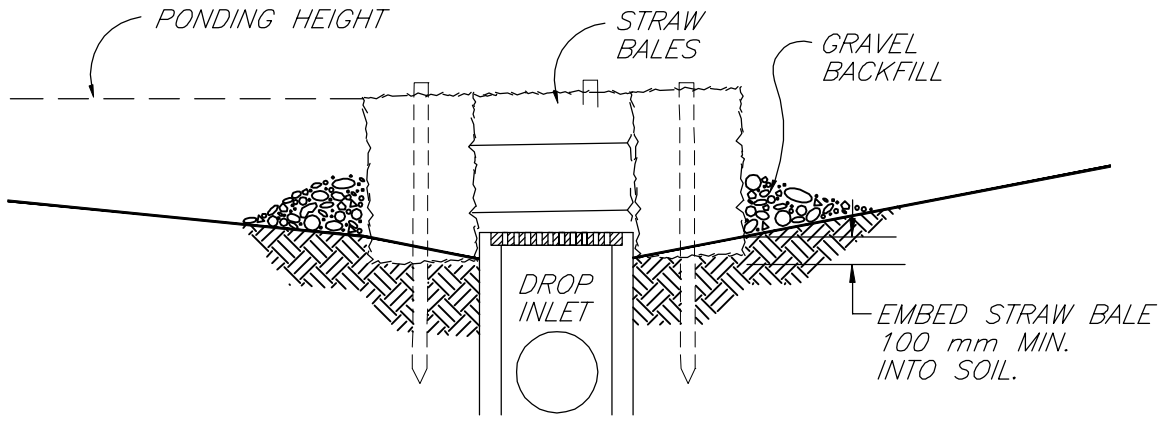

SECTION A-A

NOTES:

1. DROP INLET SEDIMENT BARRIERS ARE TO BE USED FOR SMALL, NEARLY LEVEL DRAINAGE AREAS. (LESS THAN 5%)
2. EMBED THE BALES 100 mm INTO THE SOIL AND OFFSET CORNERS OR PLACE BALES WITH ENDS TIGHTLY ABUTING. GRAVEL BACKFILL WILL PREVENT EROSION OR FLOW AROUND THE BALES.
3. THE TOP OF THE STRUCTURE (PONDING HEIGHT) MUST BE WELL BELOW THE GROUND ELEVATION DOWNSLOPE TO PREVENT RUNOFF FROM BYPASSING THE INLET. EXCAVATION OF A BASIN ADJACENT TO THE DROP INLET OR A TEMPORARY DIKE ON THE DOWNSLOPE OF THE STRUCTURE MAY BE NECESSARY.
4. THIS FIGURE IS PROVIDED FOR GUIDANCE ONLY AND DOES NOT CONSTITUTE A DESIGN. A SITE SPECIFIC DESIGN IS REQUIRED FROM DESIGNER/ENGINEER.

**STORM DRAIN DROP INLET
SEDIMENT BARRIER
(STRAW BALE / GRAVEL - OPTION)**

From: Salix-Applied Earthcare - EROSION DRAW 3.0
1994 JOHN McCULLAH
©

FILE: STRWGRVB

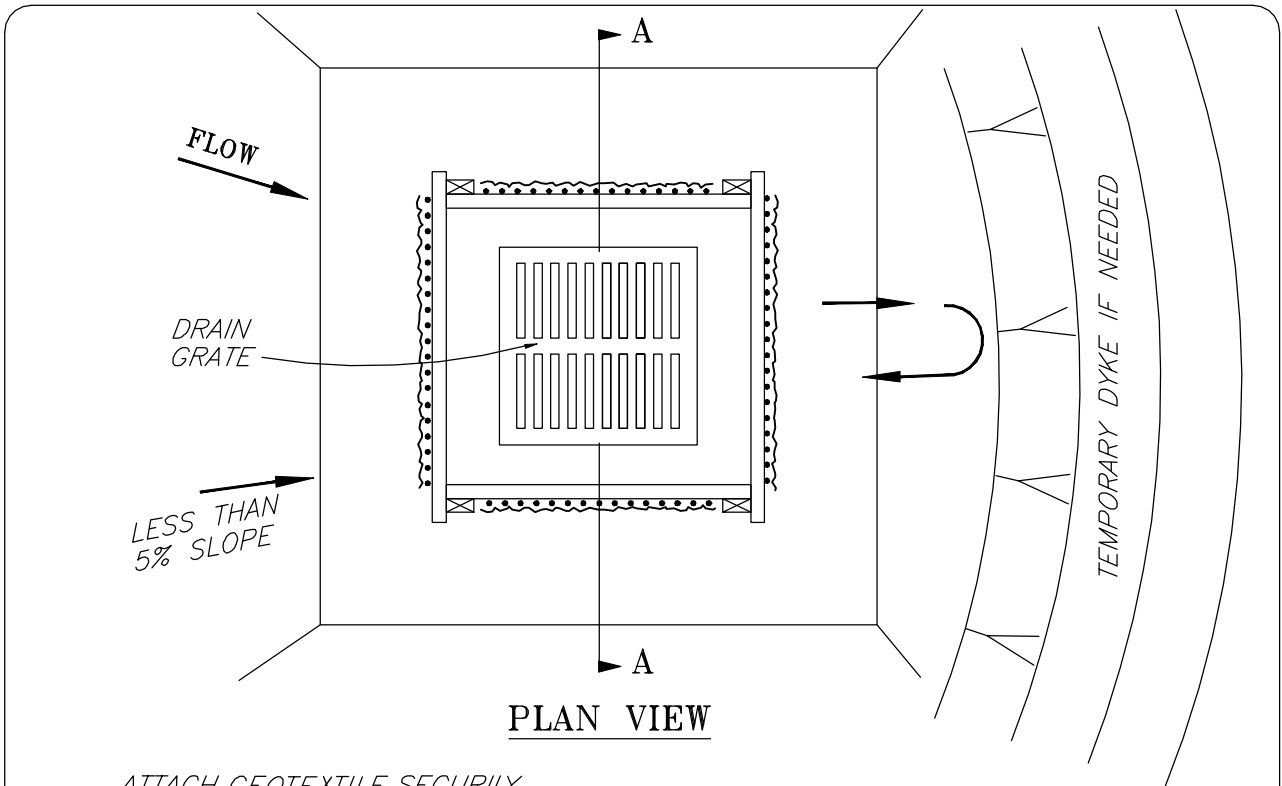

PLAN VIEW

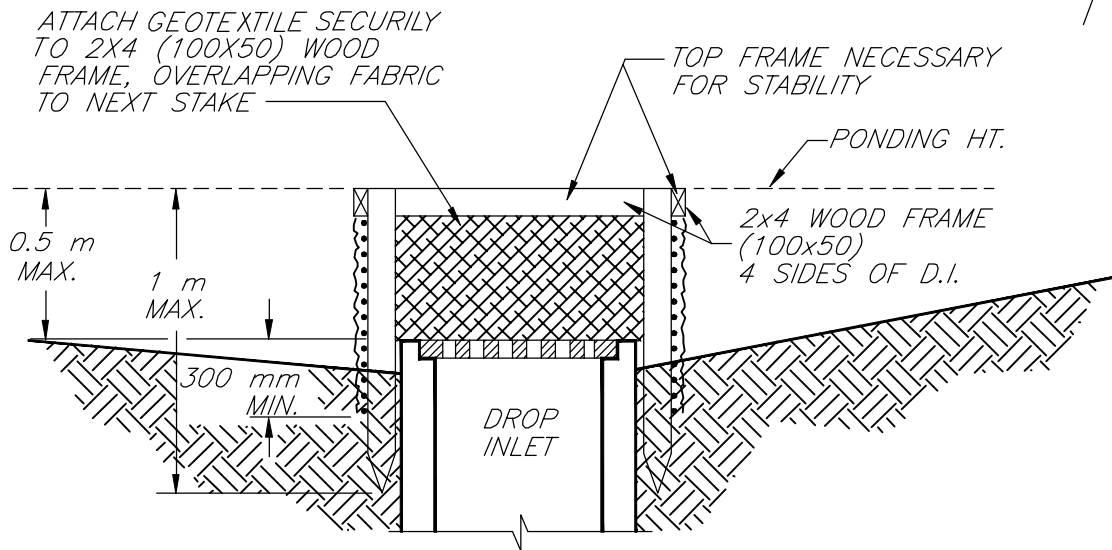

SECTION A-A

NOTES:

1. DROP INLET SEDIMENT BARRIERS ARE TO BE USED FOR SMALL, NEARLY LEVEL DRAINAGE AREAS. (LESS THAN 5%)
2. USE 2"x4" (100X50mm) WOOD OR EQUIVALENT METAL STAKES, 1 m MINIMUM LENGTH.
3. INSTALL 2"x4" (100X50mm) WOOD TOP FRAME TO INSURE STABILITY.
4. THE TOP OF THE FRAME (PONDING HEIGHT) MUST BE WELL BELOW THE GROUND ELEVATION DOWNSLOPE TO PREVENT RUNOFF FROM BY-PASSING THE INLET. A TEMPORARY DYKE MAY BE NECESSARY ON THE DOWNSLOPE SIDE OF THE STRUCTURE.
5. THIS FIGURE IS PROVIDED FOR GUIDANCE ONLY AND DOES NOT CONSTITUTE A DESIGN. A SITE SPECIFIC DESIGN IS REQUIRED FROM DESIGNER/ENGINEER.

NOT TO SCALE

**STORM DRAIN DROP INLET
SEDIMENT BARRIER
(SILT FENCE - OPTION)**

From: Salix-Applied Earthcare - EROSION DRAW 3.0
1994 JOHN McCULLAH



FILE: SILTFDIB

Description and Purpose

- Small dam constructed of rock placed across steep channel
- Decrease flow velocities to reduce erosion caused by storm runoff
- Sediment laden runoff is detained allowing sediment to settle out

Applications

- Temporary or permanent measure
- Reduces long steep grade to intervals of gentle grades between successive structures
- Reduces flow velocities and kinetic energy to decrease erosion potential caused by runoff
- Sediment laden runoff is retained behind structure allowing sediment to settle out
- May be used in channels that drain 4 ha (10 ac) or less
- May be used in steep channels where storm water runoff velocity is less than 1.5 m/s (5 fps)

Advantages

- Cheaper than using riprap armouring or gabion structures in a ditch
- Easy to construct

Limitations

- Not appropriate for high flow velocity >1.5 m/sec; (use gabion structures for flow velocity >1.5 m/sec)
- Not appropriate for channels draining areas larger than 4 ha (10 ac)
- Not to be placed in grass lined channels unless erosion is anticipated
- Susceptible to failure if water undermines or outflanks structure

Construction

- Excavate a trench key a minimum of 0.15 m in depth at the rock check structure location
- Place non-woven geotextile fabric over footprint area of rock check
- Construct structure by machine or hand
- Structure should extend from one side of the ditch or channel to the other

- Structure should be constructed so that centre of the crest is depressed to form a centre flow width which is a minimum of 0.30 m lower than the outer edges
- Height of structures should be less than 0.8 m in height to avoid impounding large volumes of runoff
- Downstream slope of the check dam should be 5H:1V (minimum)
- Upstream slope of the check dam should be 4H:1V (minimum)

Construction Considerations

- Should be designed with roadside design clear zone requirements in mind.
- Height and spacing between structures should be designed to reduce steep channel slope to intervals of flatter gradient
- Rock check structures should be constructed of free draining aggregate
- Aggregate used should have a mean diameter (D_{50}) of between 75 mm and 150 mm and must be large enough to remain in place during high velocity flow situations. Maximum rock diameter should not exceed 150 mm if the structure is to be used as a sediment trap.
- If rock check structures are to be placed in channels with significant high flows, they must be properly designed for stone size and structure spacings

Inspection and Maintenance

- Inspection frequency should be in accordance with the PESC and TESC Plans
- Remove sediment build up before it reaches one half the check structure height
- Erosion repairs should be made immediately to prevent failure of the structure
- Replace dislodged aggregate immediately with heavier aggregate or gabion structures

Similar Measures

- Synthetic Permeable (Ditch) Barriers

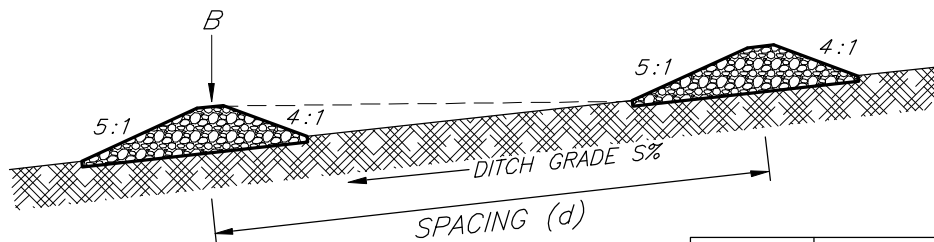
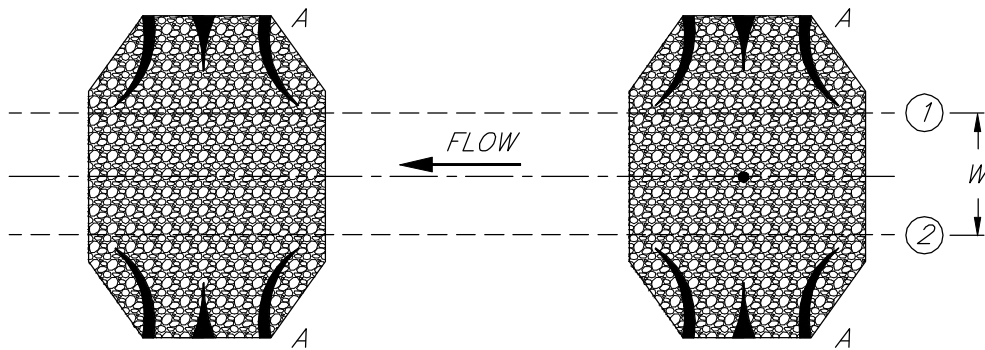
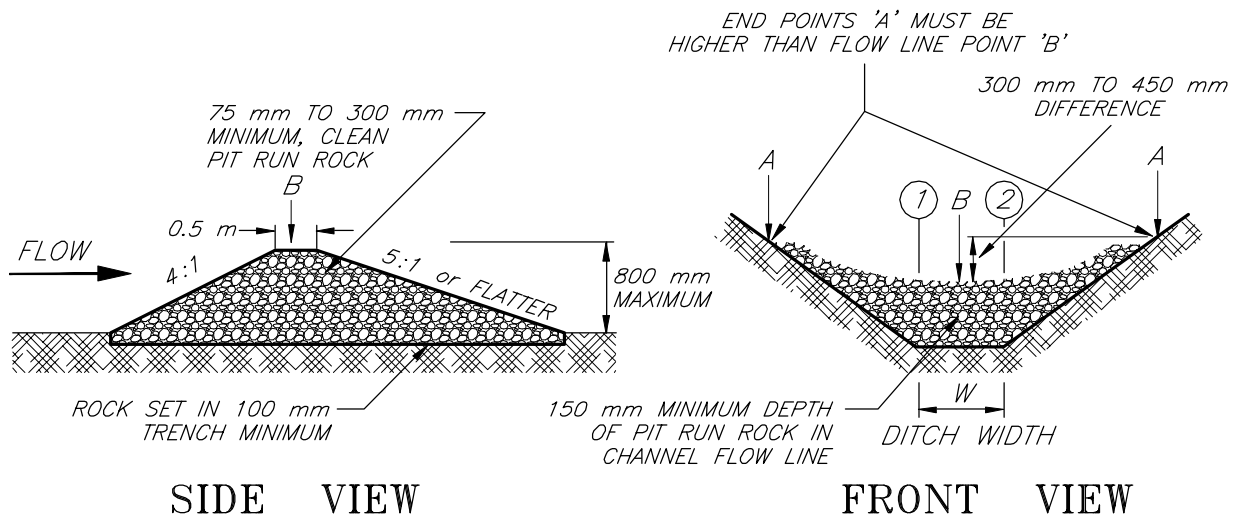

NOTES:

1. SUITABLE FOR FLOW VELOCITY ≤ 1.5 m/s.
2. SUITABLE FOR DRAINAGE AREA ≤ 4 ha.
3. SUITABLE FOR GRADES FROM 5% TO 8%.
4. SPACING (d) AND ROCK SIZE (D_{50}) TO BE DETERMINED BY ENGINEER BASED ON HYDRAULIC CONDITIONS.
5. THIS FIGURE IS PROVIDED FOR GUIDANCE ONLY AND DOES NOT CONSTITUTE A DESIGN. A SITE SPECIFIC DESIGN IS REQUIRED FROM DESIGNER/ENGINEER.

| D_{50} of ROCK (mm) | MAXIMUM FLOW DEPTH OVER ROCK (mm) |
|-------------------------------|--|
| 75 | 50 |
| 150 | 100 |

**SUGGESTED ROCK DIAMETER
AND OVERFLOW DEPTHS**

**ROCK
CHECK DAM**

NOT TO SCALE

| | |
|-------------------------------------|-----------|
| Aggregate Filled Sand Bag Check Dam | B.M.P. #8 |
|-------------------------------------|-----------|

| | |
|---------|-----------|
| Removed | B.M.P. #8 |
|---------|-----------|

| | |
|-------------------------------------|-----------|
| Aggregate Filled Sand Bag Check Dam | B.M.P. #8 |
|-------------------------------------|-----------|

| | |
|--------------------------|-----------|
| Log Check Dam Removed | B.M.P. #9 |
|--------------------------|-----------|

Description and Purpose

- Double panel, low profile, uni-body porous synthetic barriers used to dissipate flow energy and reduce velocity
- Barriers of patented design constructed of lightweight and durable synthetic materials
- May be used to create a grade break to reduce flow energy and velocities allowing some sediment to settle out at the upstream barrier panel of the barrier structure
- Can be used to dissipate flow energy and trap sediment during the period of revegetation; should be removed at successful re-establishment of vegetation

Applications

- Temporary structure
- May be placed across trapezoidal ditch to dissipate flow energy and reduce flow velocities
- Can be used to supplement as grade breaks along ditch interval between permanent drop structures along steep ditch grades
- May be used as midslope grade breaks along contours of midslope or at toe of disturbed slopes
- Usually used as grade breaks along ditch (3 to 7% grade) in conjunction with erosion control matting or non-woven geotextile as soil covering mattings; usually used in conjunction with permanent gabion structure (i.e., gabion) at steep grade (+6%) areas
- Designed to be reusable

Advantages

- Prefabricated
- Reusable/moveable
- More appropriate for installing at transition areas of changing grades of channels so that hydraulic jumps (or change of flow regime from supercritical to subcritical) may be simulated to dissipate flow energy, thus minimizing erosion potential
- Provide portable drainage control for construction sites, ditches, channels, roads, slopes
- The double panel porous barrier may allow significant energy loss as the flow of water undergoes from supercritical flow to sub-critical flow from the upstream panel

Synthetic Permeable Barrier

Erosion Control and Sediment Control

B.M.P. #10

to the downstream panel with a more laminar flow evolving downstream and roughly parallel to the stream bed. Less turbulence and erosion energy may be created when compared with cascading, over-topping and tumbling flow from drop structures (i.e., gabions, check structures, straw bales)

- Barriers constructed of UV resistant material may be left in place for final channel stabilization as UV degradation is low
- Biodegradable synthetic option available
- Observed to enhance aggregation of silt material and to function as a sediment barrier with the formation of an earth block at behind the upstream barrier panel area; the downstream flow exiting at the downstream barrier panel may be of laminar nature and less erosive

Limitations

- More appropriate for use as a grade break and may be installed between permanent drop structures
- Partially effective in retaining some sediment and reducing flow velocities
- Less sturdy as drop structures in resisting high flow impact
- Not to be designed as drop structures
- Must be hand installed
- Become brittle in winter and may be easily damaged by highway maintenance activities or by public
- At the time of deactivation of the structure after vegetation establishment, metallic anchor pins, if not biodegradable, may require removal at time of completed revegetation
- Stick-up of metallic anchor pin above ground may be a nuisance and may be a human hazard and cause damage to maintenance equipment
- The use of biodegradable anchor pins is advisable

Construction

- Install as per manufacturers recommended installation instructions
- Normally installed in conjunction with erosion control matting in ditches and channels
- Prepare soil surface
- Install basal layer of erosion mat or geotextile fabric; key-in basal mat/fabric at upstream end

Synthetic Permeable Barrier

Erosion Control and Sediment Control

B.M.P. #10

- Place and anchor barrier panels with adequate pin anchors to basal soils

Construction Considerations

- Maintain intimate contact between base of barrier and soil with laying of basal matting/fabric intimate to ground surface
- Ensure side panel of barrier is extended to outer edges of channel to sufficient height to provide freeboard of channel flow

Inspection and Maintenance

- Inspection frequency should be in accordance with the PESC and TESC Plans
- Remove sediment build-up before it reaches one-half the check structure height
- Do not damage barrier panel during removal of sediment
- Partial or non-removal of sediment build-up will create a non-permeable barrier and low level earth mini-drop structure which will force water flow over-topping the barrier. The option of non-removal of sediments may be open to converting the sediment build-up into a "vegetated earth mini-drop structure" along the ditch with the non-removal of synthetic permeable barrier in-place. This will require topsoil and seeding (or intensive mulch seeding) to promote vegetation growth
- If erosion is noted at the toe or upslope edges of the structure, hand regrading or suitable repairs should be made immediately to prevent failure of the structure
- Remove and deactivate at 1 year after vegetation is established

Similar Measures

- Silt fences or straw bales partially equivalent in retaining sediment

Design Considerations

- Install synthetic permeable barrier along ditch interval between permanent drop structures (i.e., gabion); can be economic alternative and supplemental to (i) total hard armouring of complete channel length, or (ii) high frequency of gabion installation required for high flow applications in steep ditch grade

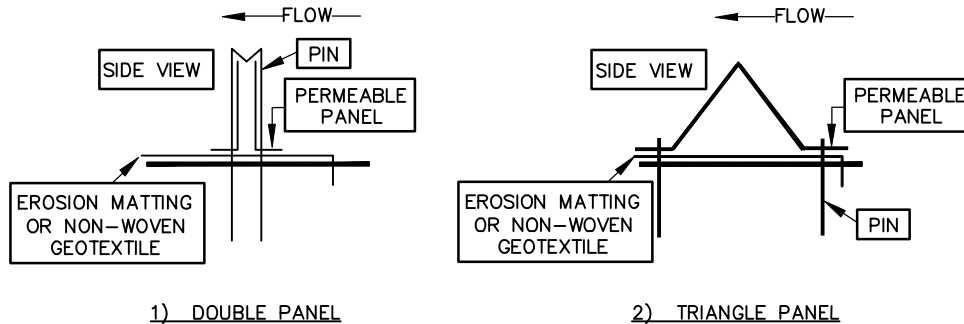
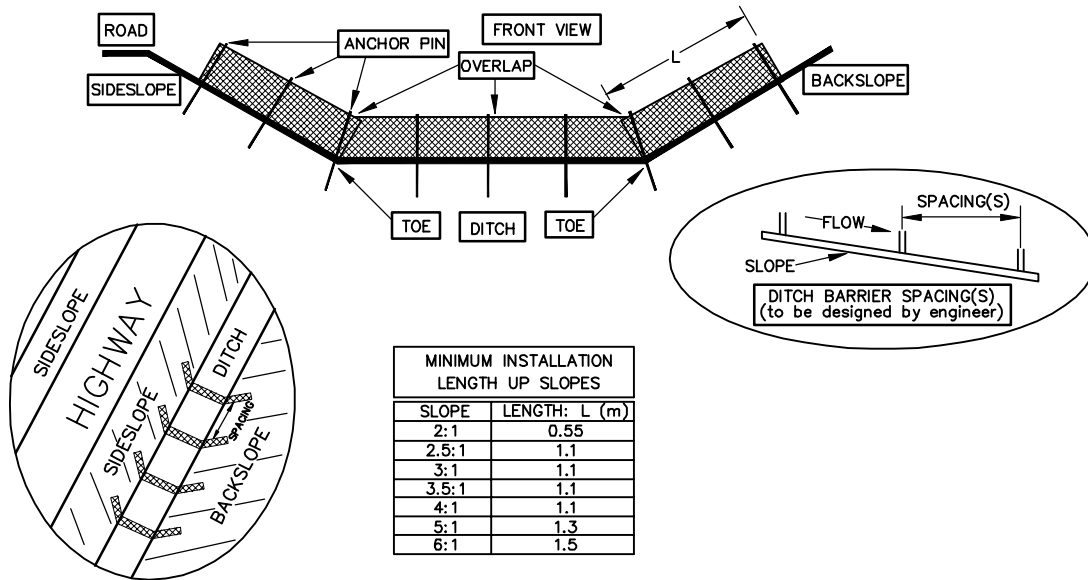

SYNTHETIC PERMEABLE DITCH BARRIER
N.T.S.

NOTES:

1. FOR USE MAINLY AS A GRADE BREAK STRUCTURE FUNCTIONING AS A FLOW ENERGY DISSIPATOR AND VELOCITY RETARDER.
2. FOR SECONDARY USE AS SEDIMENT BARRIER.
3. REQUIRES NON-WOVEN GEOTEXTILE FABRIC OR BIODEGRADABLE (COCONUT FIBRE PREFERABLE) EROSION BLANKET MAT AT BASE AND KEY-IN TO SOIL AT UPSTREAM END.
4. MAY BE INSTALLED AS GRADE BREAK AT GRADE TRANSITION AREAS TO CREATE DISSIPATION OF FLOW ENERGY AND A MORE LAMINAR FLOW REGIME DOWNSTREAM OF STRUCTURE.
5. THIS FIGURE IS PROVIDED FOR GUIDANCE ONLY AND DOES NOT CONSTITUTE A DESIGN. A SITE SPECIFIC DESIGN IS REQUIRED FROM DESIGNER/ENGINEER.

SYNTHETIC
PERMEABLE
BARRIERS

| | |
|---------------------------------|------------|
| Straw Bale Check Dam Removed | B.M.P. #11 |
|---------------------------------|------------|

Straw Bale Barrier

Sediment Control

B.M.P. #12

Description and Purpose

- A barrier of strawbale primarily used as a perimeter sediment control measure
- May be used to intercept and detain sediment laden runoff allowing a portion of the sediment load to settle out

Applications

- Temporary measure
- Suitable for flow velocities of 0.3 m/s or less
- Usually placed at 1m to 2 m offsets from toe of disturbed slopes
- Size of drainage area should be no greater than 0.1 ha per 30 m length of straw bale sediment barrier
- Maximum flow path length upstream of barrier should be less than 30 m
- Maximum slope gradient above the barrier should be no greater than 2H:1V
- May be used in conjunction with filter fabric as external wrap to encapsulate the bale

Advantages

- Straw bales are biodegradable
- Only requires one row of straw bales
- Easier to install than other barriers and economical if straw bales are readily available

Limitations

- Not appropriate for flow velocities greater than 0.3 m/s
- Require extensive maintenance following high velocity flows associated with storm events
- Not as robust as some continuous perimeter control structures
- Susceptible to undermining and erosion damage if not properly keyed into substrate soil or if joints are not completely infilled with straw
- Short service life
- Must be installed by hand
- Not to be used on asphalt or concrete covered surfaces

Straw Bale Barrier

Sediment Control

B.M.P. #12

- Availability of appropriate bales may be limited in certain areas of the province
- Maximum straw bale barrier height of one straw bale or 0.5 m maximum height

Construction

- Straw bale barrier should be located a minimum distance 1.8 m away from the toe of the slope to provide adequate ponding and sedimentation area
- Excavate a trench approximately 0.10 m deep with a width of one straw bale at the straw bale barrier location
- Place straw bales in excavated trench along contour, perpendicular to flow direction
 - Ensure twine or wire is not in contact with the soil
 - Ensure straw bale is in continuous contact with base of trench
 - Ends of barrier should be angled upslope to form enclosure to contain runoff
- Infill all joints with loose straw
- Drive two 50 mm by 560 mm section wooden stakes 1.2 m long through each straw bale, ensuring each stake is embedded a minimum of 0.15 m into soil
- Backfill and compact the upstream and downstream edges of the check structure to seat the straw bales into the subgrade

Construction Considerations

- Maximum lengths of barriers should be 40 m, including 'J-hook' or 'smile' (similar to silt fence in BMP #1) configuration, to allow escape route for excess runoff
- Barrier should be placed far enough away from toe of slope to provide adequate ponding and sedimentation area (minimum of 1.8 m away from toe of slope is recommended)
- Ends of barriers should be angled upslope (in a 'J-hook' or 'smile' configuration) to form enclosure to collect runoff
- Straw bales should be:
 - Machine-made
 - Weed free cereal crop straw such as wheat, oats, rye, or barley
 - Tightly compacted and bound with two rows of wire or synthetic string and shall show no signs of weathering
 - No more than one year old

| | |
|--------------------|------------|
| Straw Bale Barrier | B.M.P. #12 |
| Sediment Control | |

Inspection and Maintenance

- Inspection frequency should be in accordance with the PESC and TESC Plans
- Remove sediment build up before it reaches one half the check barrier height
- Erosion repairs should be made immediately to prevent failure of the structure
- Replace damaged, decayed or dislodged straw bales immediately

Similar Measures

- Silt fences
- Continuous Perimeter Control Structures
- Berm Interceptors

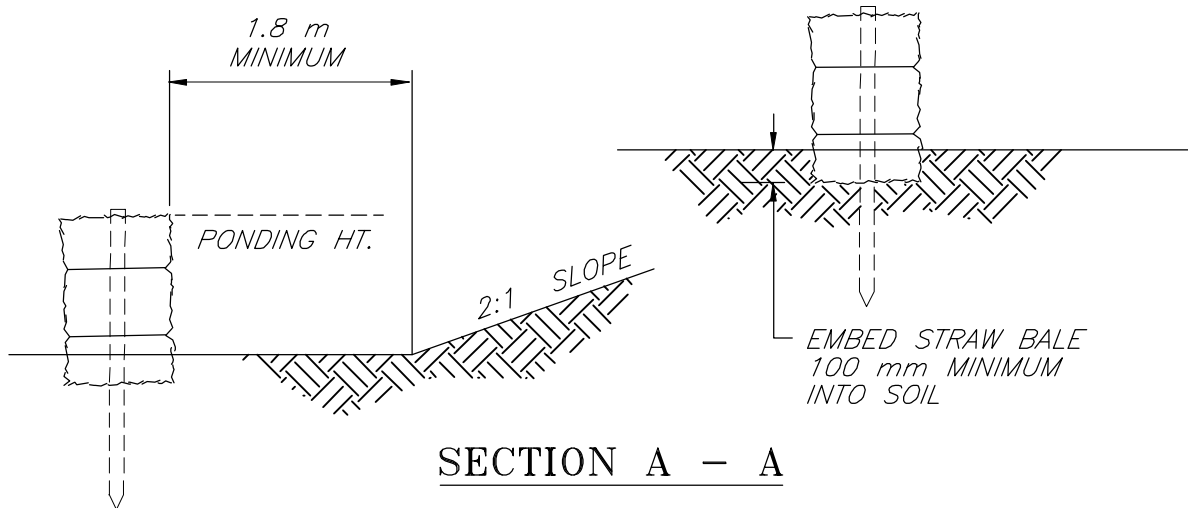

SECTION A - A

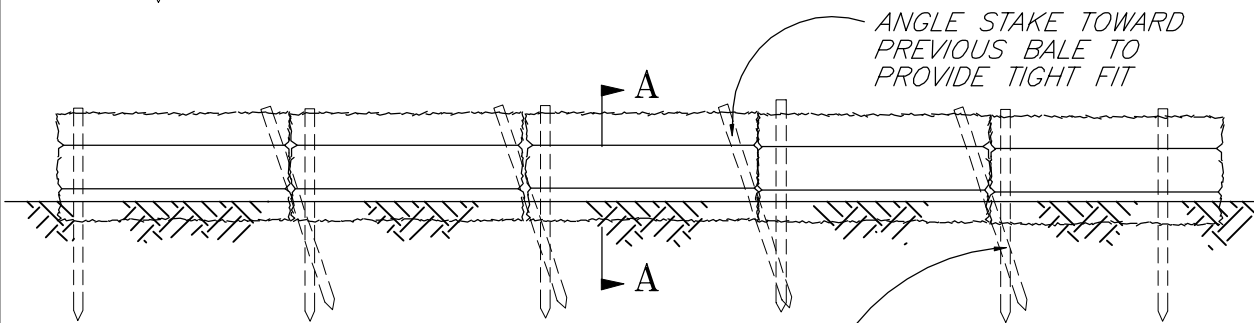

SECTION B - B

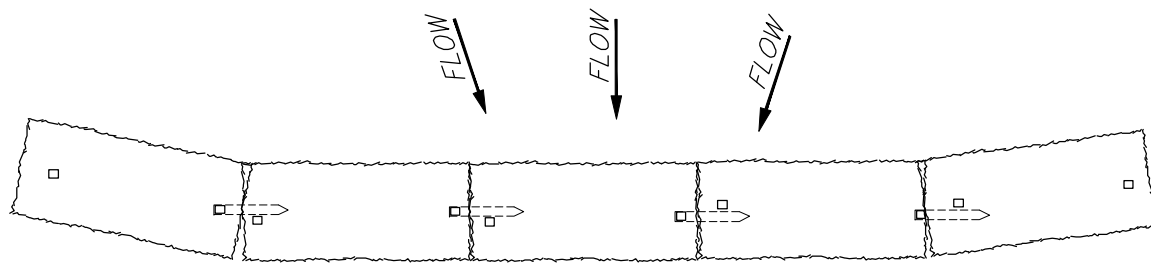

PLAN

NOTES:

1. THE STRAW BALES SHALL BE PLACED ON SLOPE CONTOUR.
2. BALES TO BE PLACED IN A ROW WITH THE ENDS TIGHTLY ABUTTING.
3. KEY IN BALES TO PREVENT EROSION OR FLOW UNDER BALES.
4. THIS FIGURE IS PROVIDED FOR GUIDANCE ONLY AND DOES NOT CONSTITUTE A DESIGN. A SITE SPECIFIC DESIGN IS REQUIRED FROM DESIGNER/ENGINEER.

**STRAW BALE
BARRIER**

From: Salix-Applied Earthcare - EROSION DRAW 3.0
1994 JOHN McCULLAH



FILE: STRWDIKE

Rolled Erosion Control Products (RECP)

- a) Channel Installation
- b) Slope Installation
- c) Straw Rolls

Erosion Control

B.M.P. #13

Description and Purpose

- Biodegradable or synthetic soil coverings used for temporary or permanent protection of disturbed soils at slopes and channels
- Categories of Rolled erosion control products (RECP) can be:
 - Erosion control blankets (ECB) (generally biodegradable and temporary)
 - Turf reinforcement mats (TRM)
 - Composite turf reinforcement mats (C-TRM)
- RECP may be manufactured of organic material, synthetic material, or as a composite of organic and synthetic materials
- Protect disturbed soils from raindrop impact and surface runoff erosion, increase water infiltration into soil, retains soil moisture and decreases evaporation loss
- Protect seeds from raindrop impact, runoff, and predators
- Stabilizes soil temperature to promote seed germination and enhance vegetation growth

Applications

- Temporary or permanent measure
- May be used to protect disturbed, exposed soils for cut or fill slopes at gradients of 2.5H:1V or steeper
- May be used on slopes where erosion potential is high
 - Silts and sands have higher erosion potential than high plastic clays
- May be used on slopes where vegetation is likely to be slow to develop
- May be used to protect disturbed exposed soils in ditches and channels (with high flow velocities) by providing additional tractive resistance cover in conjunction with a successful high density vegetative growth established

Advantages

- Degree of erosion protection is higher, more uniform, and longer lasting than for sprayed-on products (e.g., mulches)
- Wide range of commercially available temporary (biodegradable) or permanent products

Rolled Erosion Control Products (RECP)

- a) Channel Installation
- b) Slope Installation
- c) Straw Rolls

Erosion Control

B.M.P. #13

Limitations

- Non-performance of RECP may result from the following:
 - Low density vegetation growth (beneath RECP) due to non-favourable weather and growth conditions (i.e., soil type, moisture, storm events at critical times). It is noted that values of tractive resistance of RECP products for vegetative growth may be generally tested in laboratory after a growth period (e.g., 3 months) under greenhouse growth conditions. The effectiveness of RECP, especially along channels, is very dependent on success of vegetation growth on site. It is important that the designer should assess the effectiveness of RECP in accordance with site, soil, terrain and vegetation growth conditions
 - Hydraulic uplift of RECP and erosion of underlying soils can occur under rapid snow melt conditions when dammed up melt water generates a hydraulic head and high flow velocity generated in constricted snow melt channel. This situation can occur along steep channels interlaced with drop structures and with RECP lining installed in-between the drop structures. Ponding of melt water and non-anchored RECP joint areas allow flow entry beneath the RECP and generate hydraulic heads to uplift the RECP. This can occur along un-anchored edges of RECP at upper edges of ditch when snow melt occurs at tops of ditch and flow beneath the RECP. This is especially critical when underlying soil is easily erodible. (e.g., fine grained non-cohesive silty soils). It is important to trench-in and anchor the edges of the RECP installations and installed anchor pin (staples) at sufficient dense intervals
 - Ice build-up from groundwater seepage source can uplift and dislocate the RECP and causing flow beneath the RECP to erode the substrate soils. Winter ice accumulation may be related to groundwater regime and investigative design on subsurface drainage by a geotechnical engineer is required
- Can be labour intensive to install
- Must be installed on unfrozen ground
- Temporary blankets may require removal before implementation of permanent measures
- Rolled erosion control products (RECP) are not suitable for rocky sites
- Proper surface preparation is required to ensure intimate contact between blanket and soil
- Plastic sheeting can be used at sensitive slopes with precautions:
 - Plastic sheeting RECP product can be easily torn, ripped, non-biodegradable, and should be disposed of in a landfill

Rolled Erosion Control Products (RECP)

- a) Channel Installation
- b) Slope Installation
- c) Straw Rolls

Erosion Control

B.M.P. #13

- Plastic sheeting product, if used, results in 100% runoff, thus increasing erosion potential in downslope areas receiving the increased flow volumes
- Plastic sheeting should be limited to temporary covering of sensitive soil stockpiles or temporary covering of small critical unstable slope areas

Construction (Slopes)

- RECP should be installed in accordance with manufacturer's directions

The following is a general installation method:

- Prepare surface and place topsoil and seed
- Surface should be smooth and free of large rocks, debris, or other deleterious materials
- Blanket should be anchored at top of slope in a minimum 0.15 m by 0.15 m trench for the entire width of the blanket
- The blanket should be rolled out downslope
 - (1) Where the blanket roll is not long enough to cover the entire length of the slope, a minimum 0.15 m by 0.15 m check slot should be excavated at the location of the lap, and the downslope segment of blanket anchored in the check slot, similar to the method used for the top of the slope, or (2) when blankets must be spliced down the slope, place blanket end over end (shingle style with approximately 0.10 m overlap. Staple through overlapped area at 0.3 m intervals.
 - The upslope portion of blanket should overlap the downslope portion of blanket, shingle style, at least 0.15 m with staple anchors placed a maximum 0.3 m apart
 - Adjacent rolls of blanket should overlap a minimum 0.1 m
 - Anchors should be placed along central portion of blanket spaced at 4/m² minimum (0.5 m spacing) for slopes steeper than 2H:1V and 1/m² (1 m spacing) for slopes flatter than 2H:1V
 - Anchors along splices between adjacent rolls should be placed 0.9 m apart

Construction (Channels)

- **A Blanket should be installed in accordance with manufacturers directions**

The following is a general installation method

- Prepare surface and place topsoil and seed

Rolled Erosion Control Products (RECP)

- a) Channel Installation
- b) Slope Installation
- c) Straw Rolls

Erosion Control

B.M.P. #13

- Surface should be smooth and free of large rocks, debris, or other deleterious materials
- Begin by excavating a minimum 0.15 m deep and 0.15 m wide trench at the upstream end of channel and place end of RECP into trench
 - Use a double row of staggered anchors approximately 0.1 m apart (i.e., 0.2 m linear spacing) to secure RECP to soil in base of trench
 - Backfill and compact soil over RECP in trench
- Roll centre RECP in direction of water flow on base of channel
- Place RECP end over end (shingle style) with a minimum 0.15 m overlap downgrade
 - Use a double row of staggered anchors approximately 0.1 m apart to secure RECP to soil
- Full length edge of RECP at top of sideslopes must be anchored in a minimum 0.15 m deep and 0.15 m wide trench
 - Use a double row of staggered staple anchors a maximum of 0.1 m apart (i.e., 0.2 m linear spacing) to secure RECP to soil in base of trench
 - Backfill and compact soil over RECP in trench
- Overlap RECP on sideslopes (shingle style down channel) a minimum of 0.1 m over the centre RECP and secure RECP to soil with anchors spaced a maximum of 0.2 m apart
- In high flow channels, a check slot across the width of the channel is recommended at a maximum spacing of 10 m to anchor the ends of the RECP to the underlying soil
 - Use a double row of staggered staple anchors a maximum of 0.1 m apart (0.2 m linear spacing) to secure RECP to soil in base of check slot
 - Backfill and compact soil over RECP in check slot
- Anchor terminal ends of RECP in a minimum 0.15 m deep and 0.15 m wide trench
 - Use a double row of staggered anchors a maximum of 0.1 m apart (i.e., 0.2 m linear spacing) to secure RECP to soil in base of trench
 - Backfill and compact soil over RECP in trench

Rolled Erosion Control Products (RECP)

- a) Channel Installation
- b) Slope Installation
- c) Straw Rolls

Erosion Control

B.M.P. #13

Construction Considerations

- Slopes should be topsoiled and seeded prior to placing RECP
- Ensure blanket is in intimate contact with the soil by properly grading soil, removing rocks or deleterious materials, prior to placing blanket
- In channels, blankets should extend to above the anticipated flow height, with a minimum 0.5 m of free board
- For turf reinforcement mat (TRM), blanket should be placed immediately after topsoiling
- Blanket should be anchored by using wire staples, metal geotextile stake pins, or triangular wooden stakes
 - All anchors should be a minimum of 0.15 to 0.2 m in length
 - For loose soils, use longer anchors
- Blankets should be placed longitudinal to direction of flow, with fabric not stretched but maintaining contact with underlying soil
- It is essential to understand product specifications and follow manufacturers instructions on installation methods

Product Quality Assurance/Quality Control (QA/QC) Certification

RECPs should be certified by the supplier/manufacturer to ensure product performance and compliance with specified property requirements. A certificate for QA/QC testing of manufactured products is required. The performance and QA/QC testing should be carried out by reputable laboratories (e.g., TxDoT – Hydraulic and Erosion Control Laboratory OR equivalent laboratory) to ensure a commonly acceptable QA/QC standard. Dependent on product type and intended performance, the product information certificate should be provided by the product supplier/manufacturer to include the following:

- Manufacturer's Certificate on
- Performance specification
 - Permissible Tractive Resistance (include testing methods and vegetative growth conditions)
 - Permissible Flow Velocity (if available)
 - Longevity (for biodegradable or non-biodegradable products)

Rolled Erosion Control Products (RECP)

- a) Channel Installation
- b) Slope Installation
- c) Straw Rolls

Erosion Control

B.M.P. #13

- Minimum Average Roll Values (MARVs) along with specified testing methods for
 - Physical properties
 - Mass per unit area
 - Thickness
 - Tensile strength
 - UV Resistance
 - Other physical properties (for non-woven below Erosion Mat (if specified))
 - Grab tensile strength
 - Grab elongation
 - Puncture strength
 - Trapezoidal tear
 - UV Resistance

Inspection and Maintenance

- Areas covered with blankets should be inspected/remediated regularly or in accordance with the PESC and TESC Plans, especially after periods of severe rainfall or storm events, to check for blanket separation or breakage
- Any damaged or poorly performing areas should be repaired/remediated immediately. Regrading of the slope by hand methods may be required in the event of rill or gully erosion.
- Inspection and maintenance should continue until dense vegetation is established
- Areas with low vegetation density should be reseeded
- After approximately one year, a top dressing of fertilizer may be applied to improve vegetation cover and assist degradation of temporary blankets

Similar Measures

- Mulching (for slopes only)
- Riprap (primarily in channels)
- Gabion mattresses (primarily in channels)

Rolled Erosion Control Products (RECP)

- a) Channel Installation
- b) Slope Installation
- c) Straw Rolls

Erosion Control

B.M.P. #13

Design Considerations

- Assess hydraulic flow conditions and tractive stress on channel
- Assess local soil, weather and growth conditions (favourable/non-favourable) for revegetation (within 3 to 12 months) to allow a determination on use or non-use of RECP as a protective measure. If the revegetation conditions are assessed favourable, the use of RECP can be considered
- Assess suitability of a RECP product using tractive resistance data tested for (i) bare soil, and (ii) vegetated (a specified duration of growth period) condition
- It is noted that tractive resistance data are adopted as selection criteria of RECP and permissible velocity data can be provided for reference.

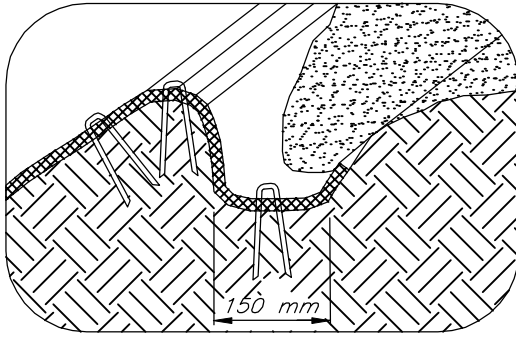

LONGITUDINAL ANCHOR TRENCH

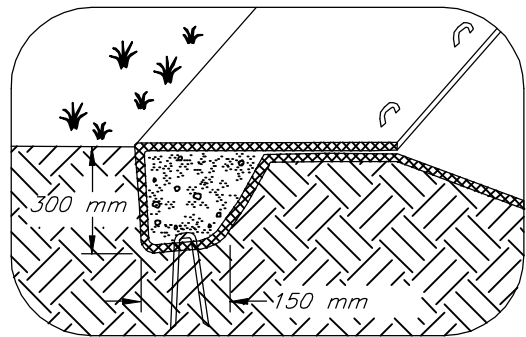

TERMINAL SLOPE AND CHANNEL ANCHOR TRENCH

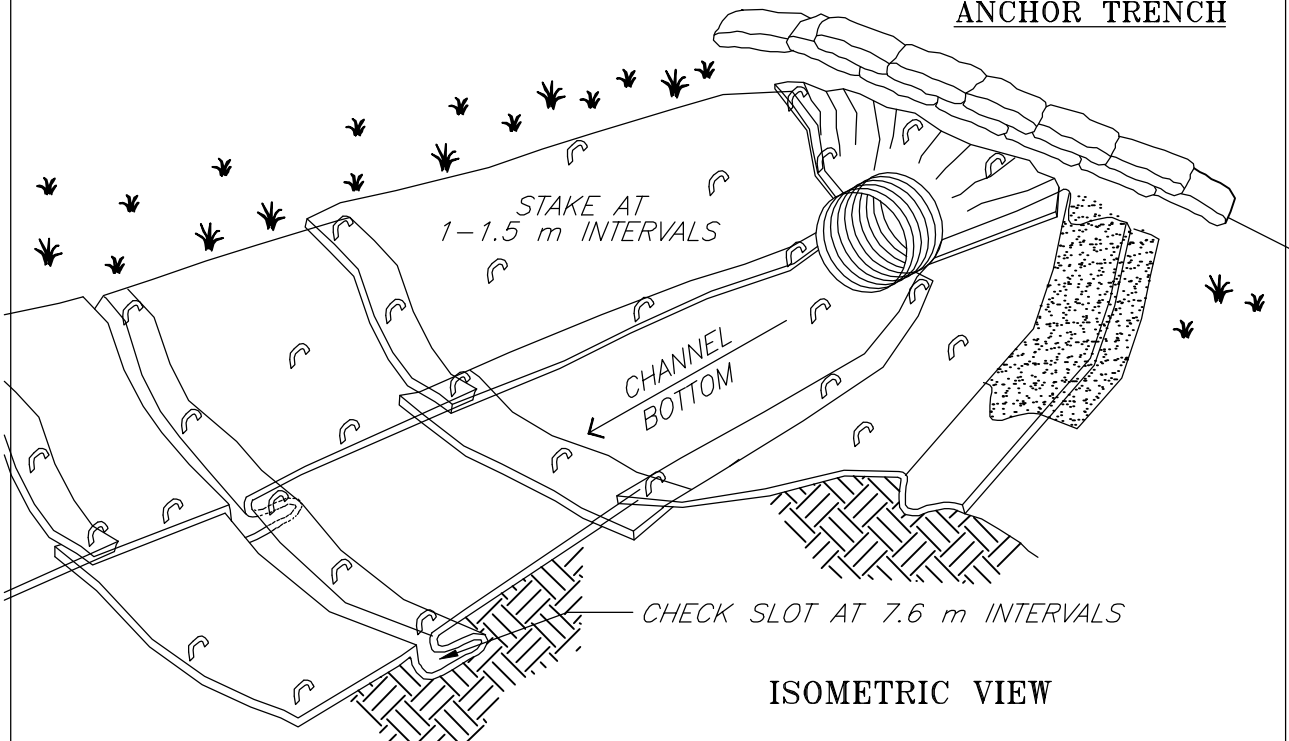

ISOMETRIC VIEW

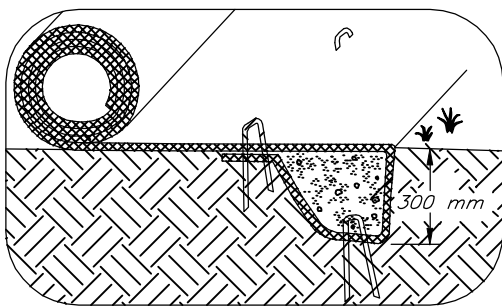

INITIAL CHANNEL ANCHOR TRENCH

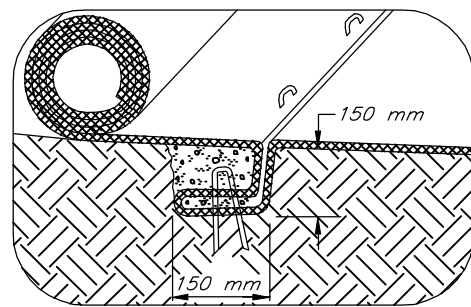

INTERMITTENT CHECK SLOT

NOTES:

1. CHECK SLOTS TO BE CONSTRUCTED PER MANUFACTURERS SPECIFICATIONS.
2. STAKING OR STAPLING LAYOUT PER MANUFACTURERS SPECIFICATIONS.
3. THIS FIGURE IS PROVIDED FOR GUIDANCE ONLY AND DOES NOT CONSTITUTE A DESIGN. A SITE SPECIFIC DESIGN IS REQUIRED FROM DESIGNER/ENGINEER.

**ROLLED EROSION CONTROL PRODUCTS (RECP)
CHANNEL INSTALLATION**

From: Salix-Applied Earthcare - EROSION DRAW 3.0
1994 JOHN McCULLAH FILE: BLNKTCHA



MATS/BLANKETS SHOULD BE INSTALLED VERTICALLY DOWNSLOPE.

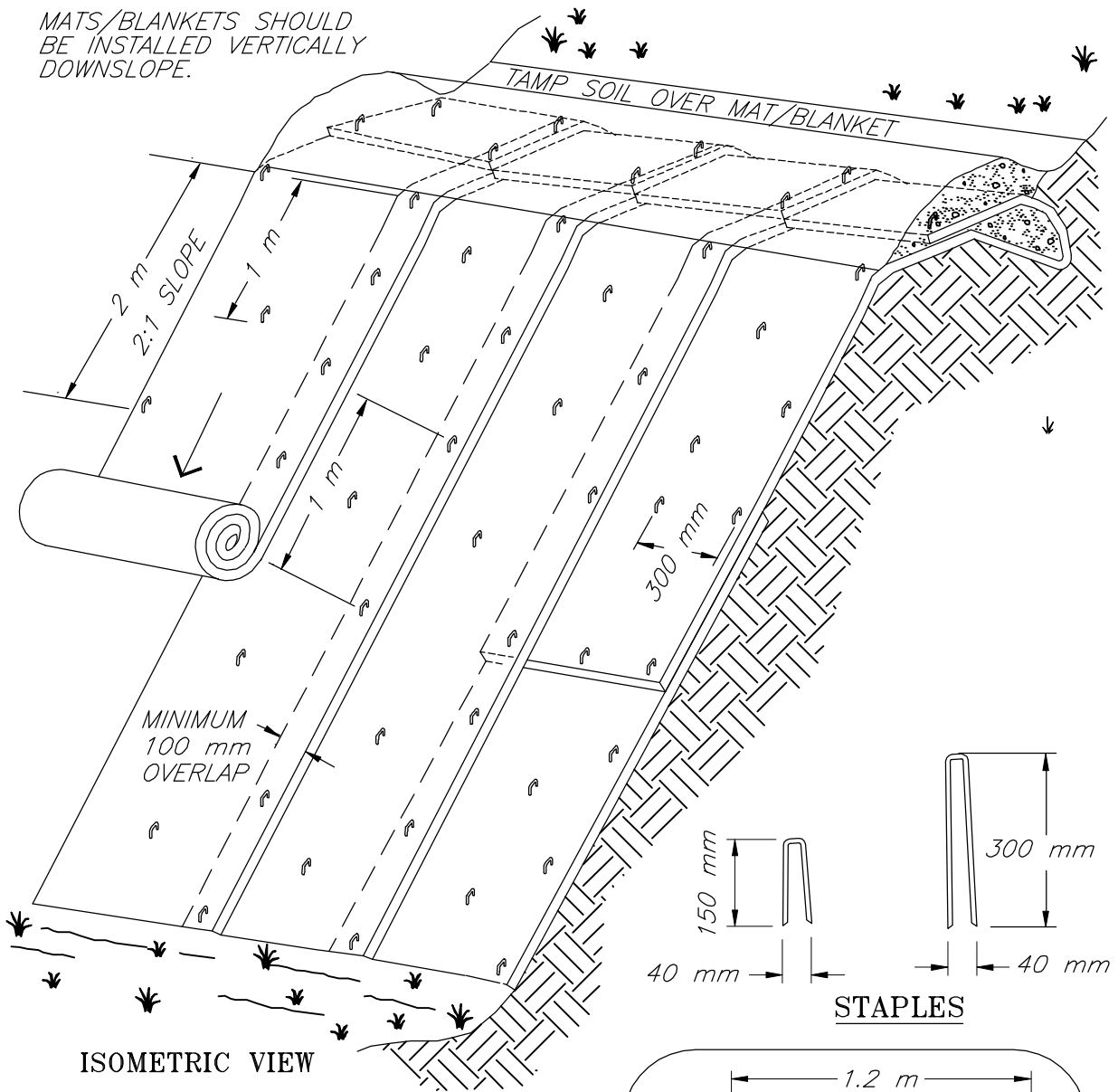

ISOMETRIC VIEW

**TYPICAL SLOPE
SOIL STABILIZATION**

NOTES:

1. SLOPE SURFACE SHALL BE FREE OF ROCKS, CLODS, STICKS AND GRASS. MATS/BLANKETS SHALL HAVE GOOD SOIL CONTACT.
2. APPLY PERMANENT SEEDING BEFORE PLACING BLANKETS.
3. LAY BLANKETS LOOSELY AND STAKE OR STAPLE TO MAINTAIN DIRECT CONTACT WITH THE SOIL. DO NOT STRETCH.
4. CHECK SLOTS, STAKING, STAPLING AND OTHER CONSTRUCTION DETAILS PER MANUFACTURES SPECIFICATIONS.
5. THIS FIGURE IS PROVIDED FOR GUIDANCE ONLY AND DOES NOT CONSTITUTE A DESIGN. A SITE SPECIFIC DESIGN IS REQUIRED FROM DESIGNER/ENGINEER.

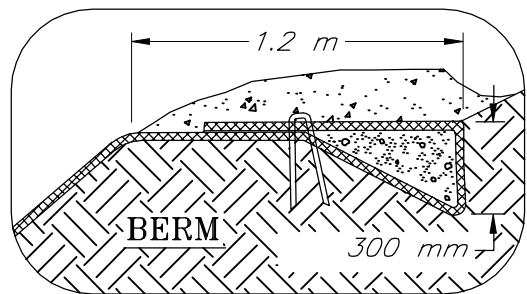

NOT TO SCALE

**ROLLED EROSION CONTROL
PRODUCTS (RECP)
SLOPE INSTALLATION**

From: Salix-Applied Earthcare - EROSION DRAW 3.0
1994 JOHN McCULLAH FILE: BLNKTSLP



Riprap Armouring

- a) Slope Protection
- b) Channel Protection

Erosion Control

B.M.P. #14
(a & b)

Description and Purpose

- Large, loosely placed cobbles or boulders placed along channel banks or slopes to protect underlying soil from erosion due to flowing water
- Can protect slopes and channel banks against erosion

Applications

- Permanent measure
- May be used on channel banks and slopes with flow velocities ranging from 2 m/s to 5 m/s (dependent on rock size and thickness); appropriate for slopes that do not exceed 2H:1V
- Riprap only needs to be placed at lower portion of channel section to the anticipated flow height (mean annual peak flow) plus freeboard
 - Other form of soft armouring (RECP blankets, seeding) can be used to promote vegetation to protect soil at upper portion of channel slopes, above riprap
- Must be used in conjunction with a non-woven geotextile underlay acting as a filtration separator with basal soil
- For fluctuating high flow channel, the riprap should be underlain by a layer of granular filter material for cyclic drawdown long-term performance with/without an extra layer of non-woven geotextile as underlay

Advantages

- Easy to install and easy to repair
- Very durable, long lasting, and virtually maintenance free
- Flexible

Limitations

- Expensive form of channel lining and stabilization
- Requires heavy equipment and transport of rock to site
- May not be feasible in areas where suitable rock is not available
- Riprap may have to be placed by hand
- Normally 2 to 3 times riprap thickness is required in comparison with gabion mattress thickness for equivalent protection performance under identical hydraulic conditions

Riprap Armouring

- a) Slope Protection
- b) Channel Protection

Erosion Control

B.M.P. #14
(a & b)

- Use of gabion is preferred at flow greater than 3 m/s due to larger nominal size of riprap and thickness required for erosion protection during flow velocities of this magnitude
- Can be classified as uniform or graded. Uniform riprap would contain stones which would contain a mixture of stones ranging from small to large. Graded riprap forms a flexible self healing cover

Construction

- Grade the slope or channel to final design grade
- Place filter (underlay) layer on prepared slope
 - Filter layer can consist of non-woven geotextile underlay and/or well graded granular material dependent on hydraulic conditions
- Place riprap layer
- Riprap should consist of a graded mixture of sound, durable stone with at least 50% of the riprap material being larger than 200 mm in diameter
- Riprap should be sized according to the following gradation and mass:

| | | Riprap Class | | | |
|---|-------------|--------------|------------|------------|--------------|
| | | 1M | 1 | 2 | 3 |
| Nominal Mass | kg | 7 | 40 | 200 | 700 |
| Nominal Diameter | mm | 175 | 300 | 500 | 800 |
| None heavier than: | kg or mm | 40 300 | 130 450 | 700 800 | 1800 1100 |
| No less than 20% or more than 50% heavier than: | kg or mm | 10 200 | 70 350 | 300 600 | 1100 900 |
| No less than 50% or more than 80% heavier than: | kg or mm | 7 175 | 40 300 | 200 500 | 700 800 |
| 100% heavier than: | kg or mm | 3 125 | 10 200 | 40 300 | 200 500 |

Percentage quoted are by mass.

Sizes quoted are equivalent spherical diameters, and are for guidance only.

Source: AT Bridge Spec. 2010

| | |
|---|---|
| Riprap Armouring a) Slope Protection b) Channel Protection Erosion Control | B.M.P. #14 (a & b) |
|---|---|

- Non-woven geotextile fabric underlay below riprap should meet the following specifications and physical properties:

**Non-Woven Geotextile Filter Fabric
Specifications and Physical Properties**

| | Class 1M, 1 and 2 | Class 3 |
|-------------------------------------|--------------------------|----------------|
| Grab Strength | 650 N | 875 N |
| Elongation (Failure) | 50% | 50% |
| Puncture Strength | 275 N | 550 N |
| Burst Strength | 2.1 MPa | 2.7 MPa |
| Trapezoidal Tear | 250 N | 350 N |
| Minimum Fabric Overlap to be 300 mm | | |

Source: AT Bridge Spec. 2010

Construction Considerations

- Riprap should be placed in a uniform thickness across the channel so as not to constrict channel width
- Blasted rock is preferred (if available)
- Riprap layer should be 1.5 to 2 times the thickness of the largest rocks used, 1.5 to 3 times the thickness of the D_{50} material, and not less than 300 mm in thickness

Inspection and Maintenance

- Inspection frequency should be in accordance with the PESC and TESC Plans
- Periodic inspections to check for erosion of protected material or movement of riprap

Similar Measures

- Rolled erosion control products (RECP) well vegetated; not for use at severe flow and high velocity areas
- Gabion mattresses

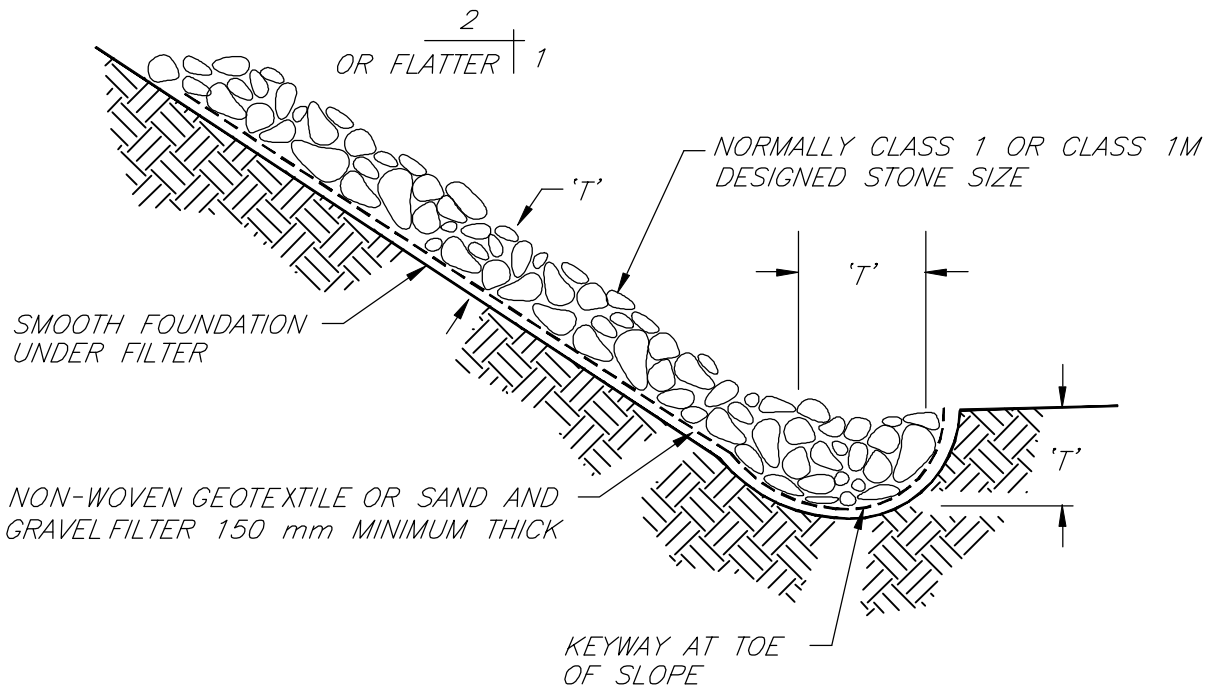

TYPICAL SECTION

NOTE:

1. 'T' = THICKNESS: THICKNESS SHALL BE DETERMINED BY THE ENGINEER.
MINIMUM THICKNESS = 300 mm. (i.e. $1.5 \times D_{50}$) FOR $D_{50} = 200$ mm.
2. THIS FIGURE IS PROVIDED FOR GUIDANCE ONLY AND DOES NOT CONSTITUTE A DESIGN. A SITE SPECIFIC DESIGN IS REQUIRED FROM DESIGNER/ENGINEER.

**RIPRAP
ARMOURING
FOR SLOPE**

From: Salix-Applied Earthcare - EROSION DRAW 3.0
1994 JOHN McCULLAH



FILE: RIPRAP

DESIGN HEIGHT (H), WIDTH AND STONE SIZE SHALL
BE DETERMINED BY THE ENGINEER

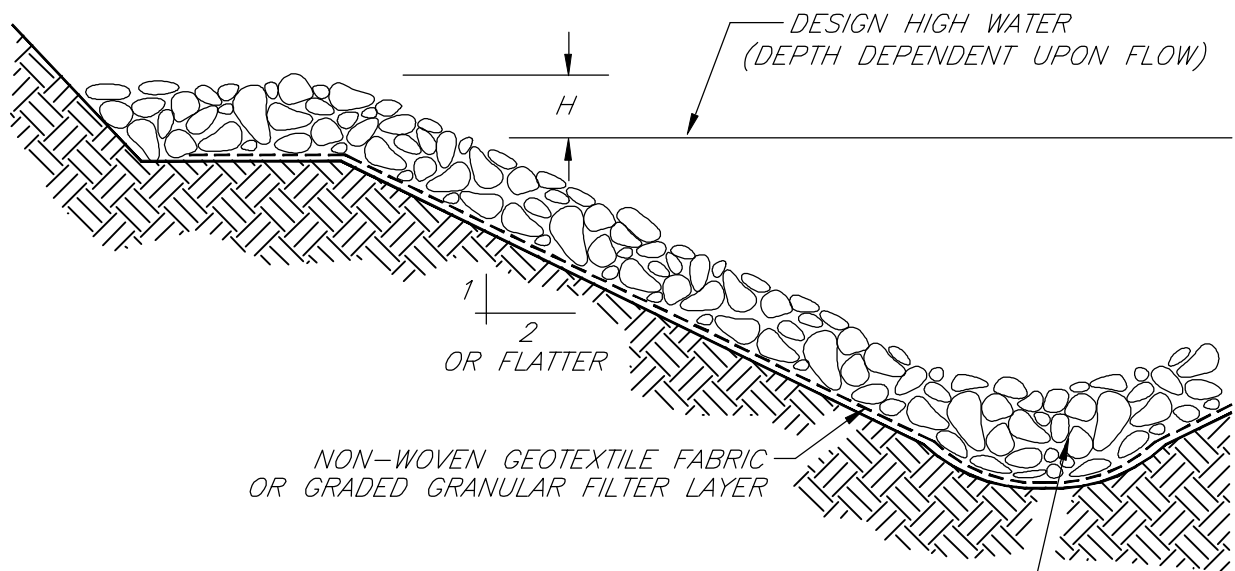

MINIMUM 300 mm THICK LAYER OF 50 mm MINIMUM
DIAMETER DRAIN ROCK. $D_{50} = 200$ mm. LARGER STONE SHALL
BE USED DEPENDENT UPON GRADIENT, SOIL TYPE, AND DESIGN FLOW.

TYPICAL SECTION

NOTES:

1. RIPRAP GRADATION AND THICKNESS SHALL BE DETERMINED BY THE ENGINEER IN ACCORDANCE WITH HYDRAULIC CONDITIONS.
2. THIS FIGURE IS PROVIDED FOR GUIDANCE ONLY AND DOES NOT CONSTITUTE A DESIGN. A SITE SPECIFIC DESIGN IS REQUIRED FROM DESIGNER/ENGINEER.

RIPRAP
ARMOURING
FOR CHANNEL

Cellular Confinement System

Erosion Control

B.M.P. #15

Description and Purpose

- 3-dimensional, plastic matting with open cells filled with topsoil or aggregate
- 3-dimensional structure stabilizes cut or fill slopes
- Cells confine infilled topsoil or aggregate and protect root zone while permitting surface drainage

Applications

- Permanent measures
- May be used with granular infill on cut or fill slopes up to a slope of 1H:1V
- May be used with granular infill on slopes and in ditches where flow velocities are 3 m/s or less
- May be used as a flexible channel lining
- May be used in temporary low-water stream crossing as granular pad for stream fording
- Matting is light, expandable, and easy to transport and place
- Use of native fill materials reduces costs; local granular fill is preferred

Limitations

- Not widely used in Alberta highway construction
 - Availability can be limited, therefore expensive in some areas
- Installation can be labour intensive
- Not to be used on slopes steeper than 1H:1V
- Slopes of 1H:1V can be hazardous to work on

Construction

- Cellular Confinement System should be installed in accordance with manufacturer's directions
- The following is a general installation method
 - Slope should be graded to design elevations and grades
 - Rocks or other deleterious debris should be removed from matting location

Cellular Confinement System

Erosion Control

B.M.P. #15

- Matting should be installed in a trench as deep as the matting is thick, extending 0.6 to 1.2 m beyond crest of slope, and matting should be installed so that the top of the matting is flush with surrounding soil
 - Every other cell along crest of slope should be anchored to soil using ‘J’ pins or other suitable sturdy anchoring device
- The matting should be rolled out downslope
- Where the blanket roll is not long enough to cover the entire length of the slope, the downslope section of matting should be butt-jointed to the upslope section and secured using staples, hog rings, or other suitable fasteners
- Adjacent rolls of matting should be butt-jointed and secured using staples, hog rings, or other suitable fasteners
- Anchors are placed at 1 m intervals down the slope
 - Additional anchors may be required to ensure matting is in intimate contact with soil
 - Additional anchors may be required along edges of matting
- Backfilling should start at the crest of the slope and proceed downslope
 - For topsoil, overfill cells approximately 25 to 50 mm and lightly compact so that top of topsoil is flush with matting
 - For granular fill, overfill cells approximately 25 mm and tamp compact so that top of fill is flush with matting
- Seeding should be applied after fill placement

Construction Considerations

- Properly grading soil surface, removing rocks or deleterious materials, prior to placing matting to ensure matting is in intimate contact with the soil
- Matting should be placed longitudinal to direction of flow or downslope
- Use only a single layer of matting
- Matting elevation should be subexcavated to thickness of matting so that the top of the matting is flush with the adjacent terrain
- Infill from top of slope ensuring placement height of fill into cellular mat is less than 1 m

Cellular Confinement System

Erosion Control

B.M.P. #15

Inspection and Maintenance

- Area covered with matting should be inspected regularly or in accordance with the PESC and TESC Plans, especially after periods of heavy rainfall storms to check for damage or loss of material
 - Any damaged areas should be repaired immediately
- Temporary inspection should continue until vegetation is established
 - Areas where vegetation fails to grow should be reseeded immediately
- If matting is broken or damaged and washout of the underlying soil occurs, the matting should be repaired or replaced after regrading the slope

Similar Measures

- Rolled erosion control products (RECP)
- Riprap armouring

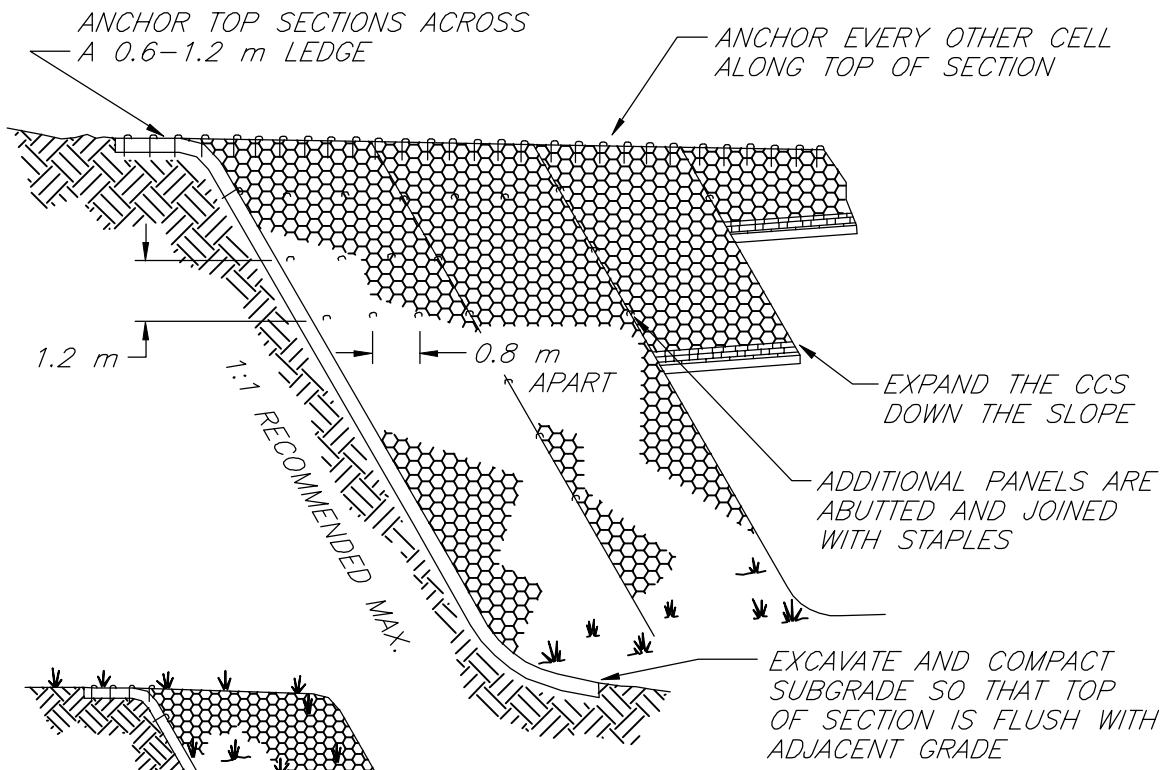

OVERFILL TOPSOIL
25-50 mm AND
LIGHTLY COMPACT

**CCS INFILLED WITH TOPSOIL
AND VEGETATED WITH GRASS**

**CCS INFILLED WITH
AGGREGATE**

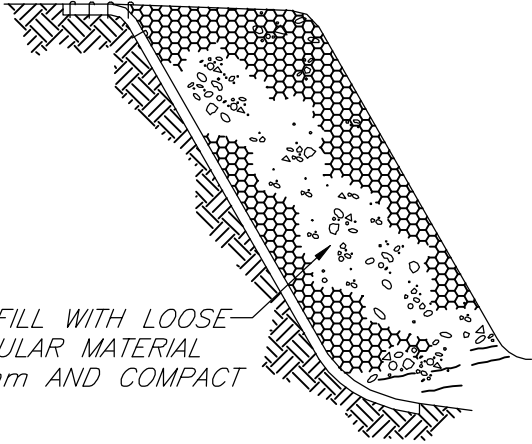

- NOTES:
1. SURFACE OF SLOPE SHALL BE LEVELED WITH GULLIES FILLED AND WELL COMPACTED.
 2. SHAPE AND COMPACT SUBGRADE SURFACES TO DESIGN ELEVATIONS AND GRADES.
 3. THE CELLS SHALL BE ANCHORED SECURELY TO PREVENT DISPLACEMENT AND DEFORMATION OF PANELS WHEN BACKFILLING.
 4. INFILL FROM CREST OF THE SLOPE TO TOE TO PREVENT DISPLACEMENT. LIMIT DROP HEIGHT TO 1 m.
 5. THIS FIGURE IS PROVIDED FOR GUIDANCE ONLY AND DOES NOT CONSTITUTE A DESIGN. A SITE SPECIFIC DESIGN IS REQUIRED FROM DESIGNER/ENGINEER.

NOT TO SCALE

**CELLULAR CONFINEMENT
SYSTEM FOR SLOPE
STABILIZATION**

From: Salix-Applied Earthcare - EROSION DRAW 3.0
1996 JOHN McCULLAH
©

FILE: CELLSYS

| | |
|----------------------------|------------|
| Gravel Blankets Removed | B.M.P. #16 |
|----------------------------|------------|

Energy Dissipators

- a) for Culvert Outlet
- b) for Trough at Bridge Headslope

B.M.P. #17

Sediment Control

Description

- a) Hard armour (riprap, gravel, concrete) placed at pipe outlets, in channels, and at downstream side of check structures to reduce velocity and dissipate energy of concentrated flows (BMP 17a)
- b) Standard Drain Trough Terminal Protection Structure generally used at bridge headslope (BMP 17b)
 - Minimizes scour at flow impact location with dissipated flow energy

Applications

- Permanent measure
- May be used at outlets of pipes, drains, culverts, conduits, or channels with substantial flows
- May be used at slope drain outlets located at the bottom of mild to steep slopes
- May be used where lined channels discharge into unlined channels
- May be used as splash pad on downstream side of gabions, check structures, berms, barriers, and silt fences to prevent erosion caused by overtopping of structure

Advantages

- Reduces flow energy in a relatively small area

Limitations

- Small rocks or stones can be dislodged during high flows
- Grouted riprap may breakup due to hydrostatic pressure, frost heave, or settlement
- May be expensive if construction materials (riprap, gravel, or concrete) is not readily available
- May be labour intensive to place and construct
- Extreme flow velocities may require paved outlet structures, stilling basins, plunge pools, drop structures, baffles, or concrete splash pads which will require special design by qualified personnel. Energy dissipators constructed of riprap may not be adequate for extreme flow velocities

Energy Dissipators

- a) for Culvert Outlet
- b) for Trough at Bridge Headslope

B.M.P. #17

Sediment Control

Construction

- Grade the area to final design grades and elevations
- Sub-excavate energy dissipator location to thickness of energy dissipator
- Place filtration bedding material on base of excavation
 - Bedding can be comprised of well graded sand and gravel or non-woven geotextile
 - Acts as separating filter between fine grained subgrade and riprap size energy dissipator material
- Place energy dissipator material (riprap, gravel, concrete) over filtration bedding material
 - Top of energy dissipator should be flush with surrounding grade

Construction Considerations

- Length of energy dissipator (L_a) at outlets shall be of sufficient length to dissipate energy
 - $L_a = 4.5 \times D$ (where D is the diameter of the pipe or channel at the outlet)
 - Energy dissipator should extend upstream of the outlet approximately a minimum distance of $0.5 \times D$
- Width of energy dissipator (W_a) at outlets shall be of sufficient width to dissipate energy
 - $W_a = 4 \times D$
- Thickness of energy dissipator (d_a) at outlets shall be of sufficient thickness to dissipate energy
 - $d_a = 1.5 \times$ maximum rock diameter (with a minimum thickness of 0.30 m)
- Energy dissipator (splash pad, apron) shall be set at zero grade and aligned straight, with the direction of flow at the outlet
- Bedding (filtration) layer can comprise either non-woven geotextile or a minimum of 0.15 m well graded sand and gravel layer
- Energy dissipator should be constructed of well-graded riprap
 - Minimum $D_{50} = 150$ mm. Preferable $D_{50} = 300$ mm
 - Minimum thickness = a) $1.5 \times D_{50}$ or b) 0.30 m to 0.45 m thickness (a or b whichever is greater)

| | |
|--|-------------------|
| Energy Dissipators a) for Culvert Outlet b) for Trough at Bridge Headslope Sediment Control | B.M.P. #17 |
|--|-------------------|

- Energy dissipator shall be designed to accommodate a 10-year peak runoff or the design discharge of the upstream channel, pipe, drain, or culvert, whichever is greater
- The energy dissipator shall be constructed flush with the surrounding grade and shall be directly in line with direction of outlet flow

Inspection and Maintenance

- Inspection frequency should be in accordance with the PESC and TESC Plans
- Any damage should be repaired immediately

Similar Measures

- Gabion mattresses

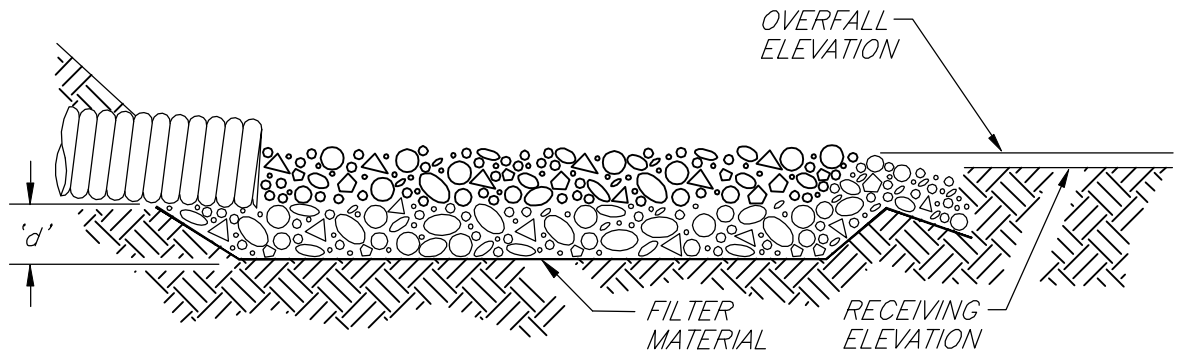

B) MINIMUM THICKNESS = 300 mm. (i.e. $1.5 \times D_{50}$) FOR $D_{50} = 200$ mm.

SECTION

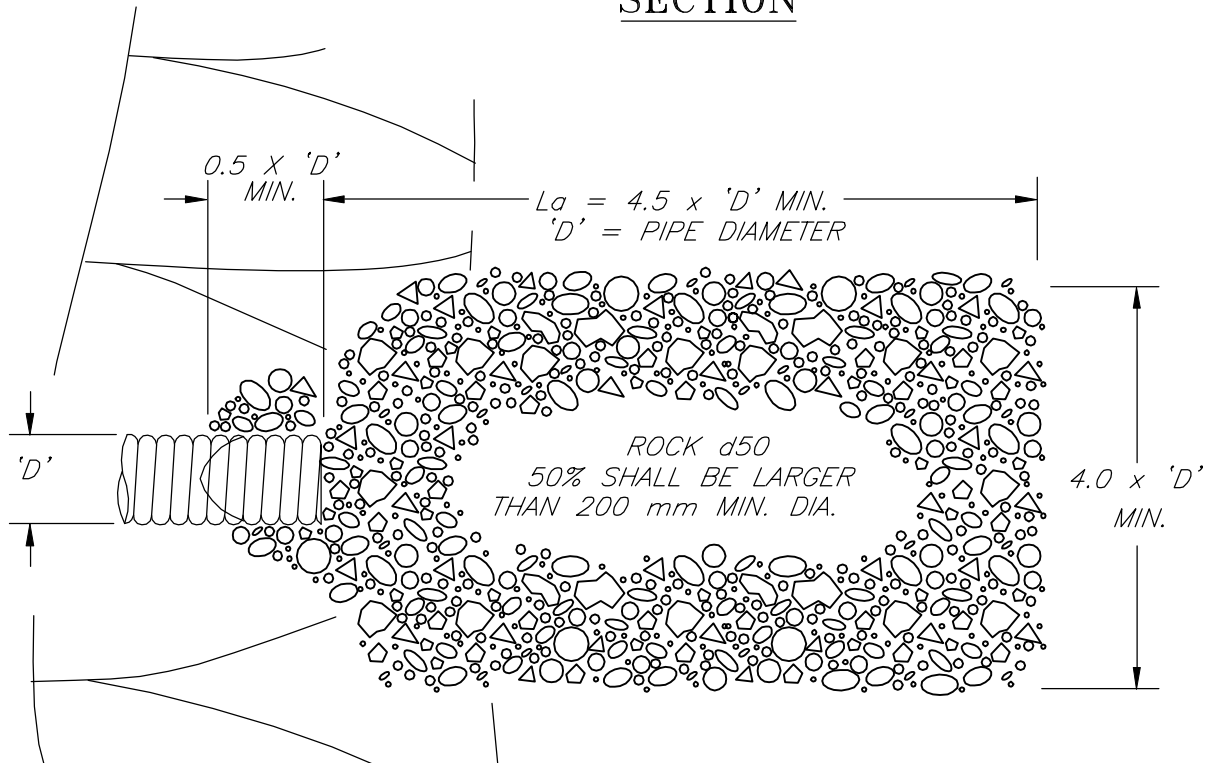

PLAN

NOTES:

1. 'La' = LENGTH OF APRON. DISTANCE 'La' SHALL BE OF SUFFICIENT LENGTH TO DISSIPATE ENERGY.
2. APRON SHALL BE SET AT A ZERO GRADE AND ALIGNED STRAIGHT.
3. FILTER MATERIAL SHALL BE FILTER FABRIC OR 150 mm THICK MINIMUM GRADED GRAVEL LAYER.
4. FOR PIPE DIAMETER > 600 mm, DESIGN BY ENGINEER IS REQUIRED.
5. THIS FIGURE IS PROVIDED FOR GUIDANCE ONLY AND DOES NOT CONSTITUTE A DESIGN. A SITE SPECIFIC DESIGN IS REQUIRED FROM DESIGNER/ENGINEER.

ENERGY DISSIPATOR FOR CULVERT OUTLET

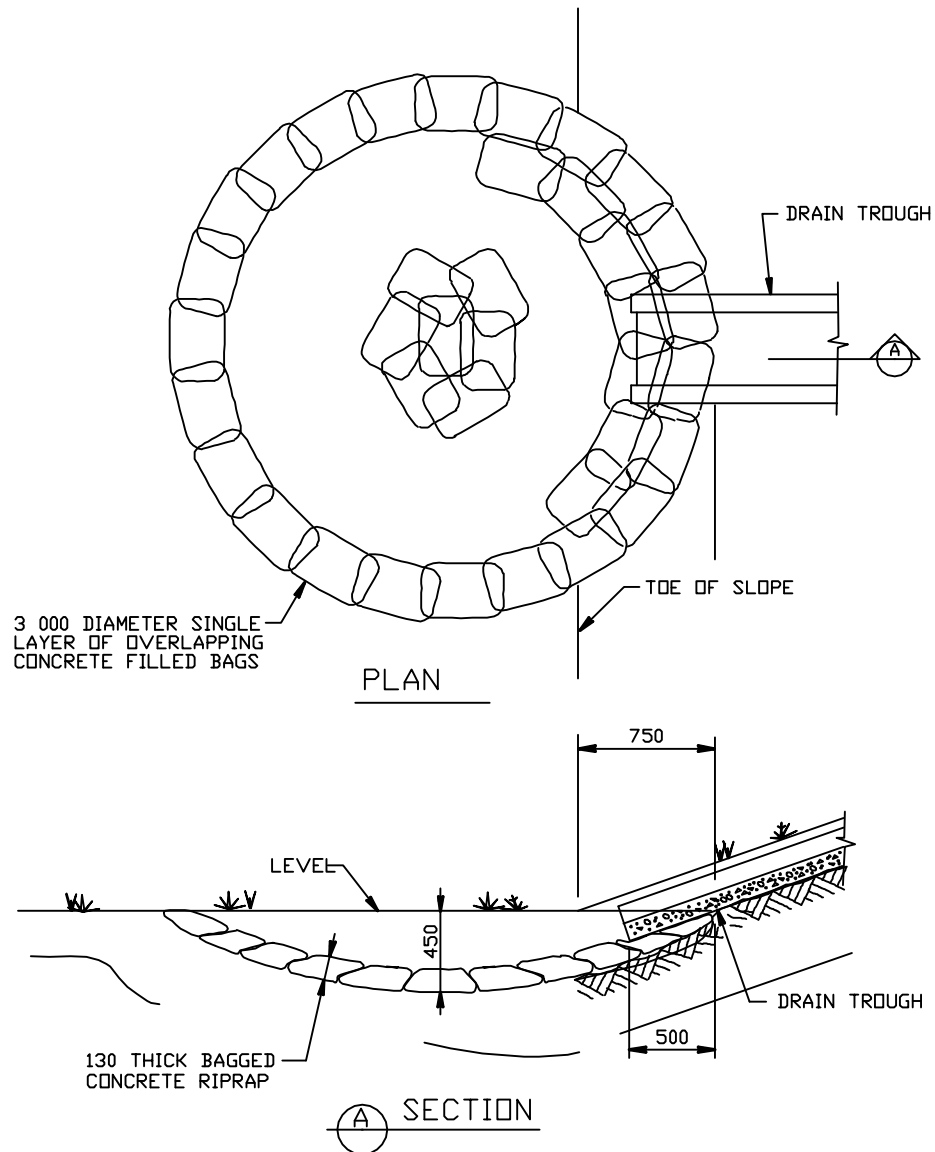

GENERAL NOTES

- DIMENSIONS ARE GIVEN IN mm. DETAILS ARE NOT TO SCALE.
- PLACING OF BAGGED CONCRETE RIPRAP SHALL START AT THE BOTTOM CENTRE OF THE DISHED AREA AND SHALL PROCEED IN A CONTINUOUS SPIRAL FASHION OUTWARD UNTIL THE ENTIRE DISH IS COVERED. EACH CONCRETE FILLED BAG SHALL LAP OVER THE EDGES OF THE PREVIOUSLY PLACED BAGS.

SOURCE: ALBERTA TRANSPORTATION SPECIFICATIONS FOR BRIDGE CONSTRUCTION
DRAWING: S-1410-91

- THIS FIGURE IS PROVIDED FOR GUIDANCE ONLY AND DOES NOT CONSTITUTE A DESIGN. A SITE SPECIFIC DESIGN IS REQUIRED FROM DESIGNER/ENGINEER.

**ENERGY DISSIPATOR
FOR SEMI-CIRCULAR TROUGH
DRAIN TERMINAL PROTECTION
FOR BRIDGE HEADSLOPE**

Sediment Traps and Basins

- a) Riser Outlet Option
- b) Permeable Rock Berm Outlet Option

B.M.P. #18

Sediment Control

Description and Purpose

- Low height dam enclosure for impoundment of sediment laden storm water, sedimentation of silt size particles and release of treated storm water
- Used to trap sediment laden run off and promote settlement of sediment prior releasing to enter downstream or watercourses
- Constructed by excavating a pond or building embankments above the original ground surface
- Sediment traps and basins can be divided on size of pond impoundment enclosure
 - Basin (Type I) for pond area $\geq 500 \text{ m}^2$
 - Trap (Type II) for pond area $\leq 500 \text{ m}^2$

Applications

- Permanent measure
- Used at terminal or selective intermediate points of concentrated runoff for impoundment of runoff and sedimentation of silt prior to release of treated runoff downstream
- Used as sedimentation control measure at perimeter of construction sites where sediment laden run off may enter watercourses, storm drains, or other sensitive areas
- Used where there is a need to impound a significant amount of sediment from significant areas of land disturbance
- Sediment basins (Type I) used for disturbed drainage areas greater than 2.0 ha
- Sediment traps (Type II) used for disturbed drainage areas of 2.0 ha, or less
- Where practical, contributing drainage areas should be subdivided into smaller areas and multiple sedimentation impoundment installed

Advantages

- High capacity of runoff impoundment and more efficient means of sedimentation necessary along perimeters of construction sites with high risk sensitive environmental areas and watercourses
- Sediment can be cleaned out easily
- Robust
- Can be deactivated easily by breaching the enclosure dyke

Sediment Traps and Basins

- a) Riser Outlet Option
- b) Permeable Rock Berm Outlet Option

B.M.P. #18

Sediment Control

Limitations

- Sediment traps and basins do not remove 100% of the sediment; net efficiency for sedimentation of silt may be around 50% dependent on design
- Anticipated service life of 3 years or longer due to possible clogging of outlets in the long-term
- Sedimentation traps and basins with a riser outlet should have an auxiliary spillway with adequate erosion protection to permit overflow in the event that the riser pipe outlet clogs during a storm event
- For drainage areas greater than 40 ha, multiple basins may be required
- Efficiency on sedimentation is very dependent on surface area; sediment basins require large surface areas to permit settling of sediment
- Fences and signage may be required to reduce danger to the public
- May provide breeding habitat for mosquitoes and other pests
- Sediment traps only remove medium and large diameter silt particles and upstream erosion or sediment control measure is required to reduce the amount of sediment laden to the runoff at downstream sensitive areas
- Periodic removal of sediment build up is required

Construction

- The consequences of failure for any water retaining structure will determine the level of effort in the design and construction phases. The construction guidelines presented herein are minimum requirements. A geotechnical engineer should design water retaining structures if the consequences of failure warrant.
- All footprint area for embankment dyke should be stripped of vegetation, topsoil, and roots to expose mineral subgrade soils
- Embankment fill material should be clean mineral soil with sufficient moisture to allow proper compaction
 - Fill should be placed in lifts not exceeding 150 mm in compacted thickness and should be compacted to a minimum of 95% Standard Proctor maximum dry density (SPD)
- The main outlet structure should be installed at farthest possible point from inlet
 - Outlet should be placed on firm, smooth ground and should be backfilled to 95% SPD
 - Proper inlet and outlet protection should be installed to protect from scour

Sediment Traps and Basins

- a) Riser Outlet Option
- b) Permeable Rock Berm Outlet Option

B.M.P. #18

Sediment Control

- Outlet pipe should consist of corrugated steel pipe to protect (against pinching and blockage)
- The embankment should be topsoiled, seeded or protected with gravel or riprap immediately after construction
- Construct an emergency spillway to accommodate flows not carried by the principle outlet
 - Emergency spillway should consist of an open channel (earth or vegetated) over native undisturbed soil (not fill)
 - If spillway is elevated, it should be constructed of riprap
 - Spillway crest should be depressed at least 0.15 m below embankment

Construction Considerations

- Preferable to strip to mineral soil only along the footprint area required for dyke construction; can leave pond floor centre area cleared but unstripped
- Can be constructed by excavating, constructing embankments, or a combination of the two methods
- Baffles should be provided to prevent short-circuiting of flow from inlet to outlet
- Construct sediment ponds and basins at site perimeter and environmentally sensitive areas prior to wet season and construction activities
- Sediment pond/basin bottom should be flat or gently sloping towards outlet
- Dyke slopes should not be steeper than 2H:1V and should be compacted
- Basins should be located where:
 - Low embankment can be constructed across a swale or low natural terrain
 - It is accessible for maintenance work, including sediment removal

Inspection and Maintenance

- Regular inspection is required to identify seepage, structural soundness, outlet damage or obstruction and amount of sediment accumulation
- Inspection frequency should be in accordance with the PESC and TESC Plans
- Sediment should be removed upon reaching 1/2 height of the containment berm or within 0.4 m of crest of embankment
- Sediment traps may be deactivated or removed after vegetation of previously disturbed upstream areas has been established

Sediment Traps and Basins

- a) Riser Outlet Option
- b) Permeable Rock Berm Outlet Option

B.M.P. #18

Sediment Control

Design Considerations

- The design can consist of (a) a riser outlet option or (b) a permeable rock berm outlet option. (The permeable rock berm outlet option is preferable for Alberta highway construction)
- Minimum particle size for riprap rock shall be 200 mm
- If the design of a riser outlet is utilized
 - Main outlet pipe shall be fabricated from corrugated steel pipe conforming to CSA Standard CAN 5-G401-M81 or the latest revision thereof
 - Outlet pipe shall consist of a horizontal pipe welded to a similar vertical riser at a 45E mitre joint
- Close to the base of the riser pipe, a 100 mm diameter hole shall be fabricated and a mesh with 12 mm square openings tack welded over the hole as a screen
 - A similar hole shall be provided along the riser pipe immediately above the elevation of the maximum sediment build-up (usually 0.4 m below crest of embankment)

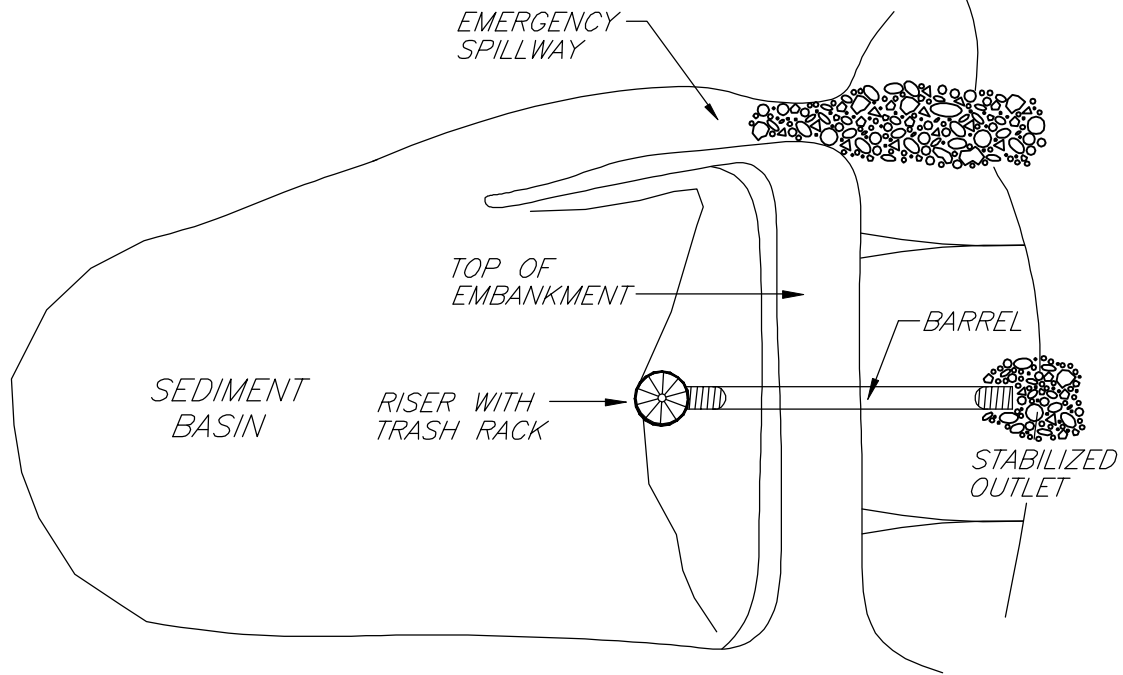

PLAN

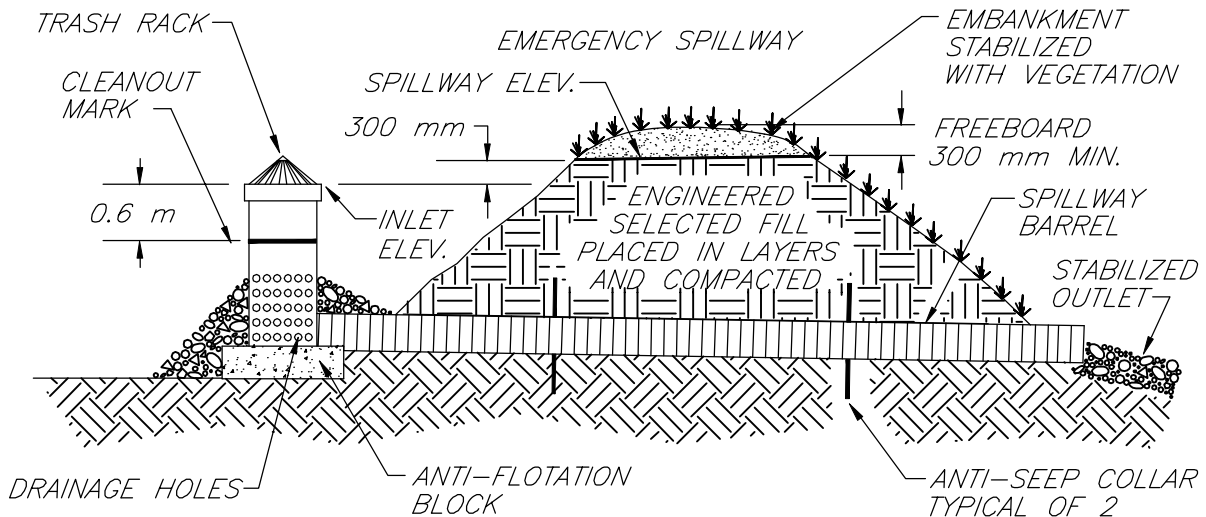

SECTION

NOTES:

1. THE TEMPORARY SEDIMENT BASIN, DESIGNED BY A QUALIFIED PROFESSIONAL, IS REQUIRED FOR DISTURBED AREAS GREATER THAN 2.02 HECTARES (5 ACRES) WITH A DRAINAGE AREA LESS THAN 40.4 HECTARES (100 ACRES).
2. THE SEDIMENT BASIN MAY BE REMOVED WITHIN 3 YEARS.
3. HEIGHT OF ENGINEERED SELECTED FILL EQUAL TO 1 m.
4. FOR CONFIGURATION AND FLOW CHAMBER DESIGN (i.e. LENGTH(L) & WIDTH(W_e) OF BASIN), REFER TO BMP 18b.
5. THIS FIGURE IS PROVIDED FOR GUIDANCE ONLY AND DOES NOT CONSTITUTE A DESIGN. A SITE SPECIFIC DESIGN IS REQUIRED FROM DESIGNER/ENGINEER.

**TYPICAL SEDIMENT
BASIN
(RISER OUTLET
OPTION)**

From: Salix-Applied Earthcare - EROSION DRAW 3.0
1994 JOHN McCULLAH



FILE: SEDBASIN

Slope Drains

- a) Slope Drain
- b) Overside Drain

Sediment Control

B.M.P. #19

Description and Purpose

- Heavy duty, flexible pipe "Big O" that carries water from top to bottom of fill or cut slope to prevent concentrated water flowing downslope and eroding face of slope

Applications

- Temporary or permanent measure
- Used on cut or fill slopes where there is a high potential for upslope runoff waters to flow over the face of the slope causing erosion, especially at areas where runoff converges resulting in concentrated runoff flows (e.g., possible breach of low catchwater ditch at top of a cut slope)
- Used in conjunction with some form of water containment or diversion structures, such as diversion channels, berms, or barriers, to convey upslope runoff water and direct water towards slope drain

Limitations

- Pipes must be sized correctly to accommodate anticipated flow volumes
- Water can erode around inlet if inlet protection is not properly constructed
- Erosion can occur at base if outlet protection or energy dissipator is not constructed
- Slope drain must be anchored securely to face of slope

Construction

- Construct diversion or intercept channel, ditch block, barrier, or other inflow apron structure at crest of slope to channel flow toward the slope drain inlet
- Install slope drain through inlet berm or barrier with a minimum of 0.45 m of soil cover above top of drain pipe to secure the inlet
 - Install scour inlet protection (such as riprap, sand bags)
- Install energy dissipator (such as riprap, gravel, concrete) at downslope outlet end of slope drain
 - Outlet must not discharge directly onto unprotected soil
- Secure the pipe from movement by tying to steel anchor stakes, hold-down grommets, or other approved anchor method
 - Space anchors on each side of drain pipe at maximum 3 m intervals along entire length of drain pipe

| | |
|--|--------------------------|
| <p>Slope Drains a) Slope Drain b) Overside Drain Sediment Control</p> | <p>B.M.P. #19</p> |
|--|--------------------------|

– Anchor stakes should have a minimum 1 m embankment

Construction Considerations (For guidance only)

- Use coiled drain pipe for low flows only
- If constructing inflow apron at crest of slope out of sandbags, only fill each sandbag ¾ full, this will allow sandbag to be flexible enough to mould around drain pipe and remain in continuous contact with the ground
- Several slope drains may be required if upslope drainage areas are too large for one drain pipe

| Size of Slope Drain | |
|-----------------------------------|---------------------------|
| Maximum Drainage Area (ha) | Pipe Diameter (mm) |
| 0.2 | 300 |
| 0.6 | 450 |
| 1.0 | 530 |
| 1.4 | 600 |
| 2.0 | 760 |

Inspection and Maintenance

- Inspection frequency should be in accordance with the PESC and TESC Plans
- Repair any damaged section of pipe immediately
- **If evidence exists of pipe movement, install additional anchor stakes to secure and anchor at zones of movement**
- Remove sediment from upslope inflow apron area after each storm event otherwise either downslope sediment transport will occur or cause the drainpipe to be plugged which could result in overtopping of inflow apron structure and sheet flow over slope face

Similar Measures

- Rock lined channel
- Permanent Pipe (slope drains)
 - Corrugated steel pipe (CSP) downdrain (AT Drawing No. CB-6 2.4 M17)
 - Half-round corrugated steel (1/2 CSP) downslope drain (AT Drawing No. CB-6 2.4 M4) for low flow areas such as bridge headslopes

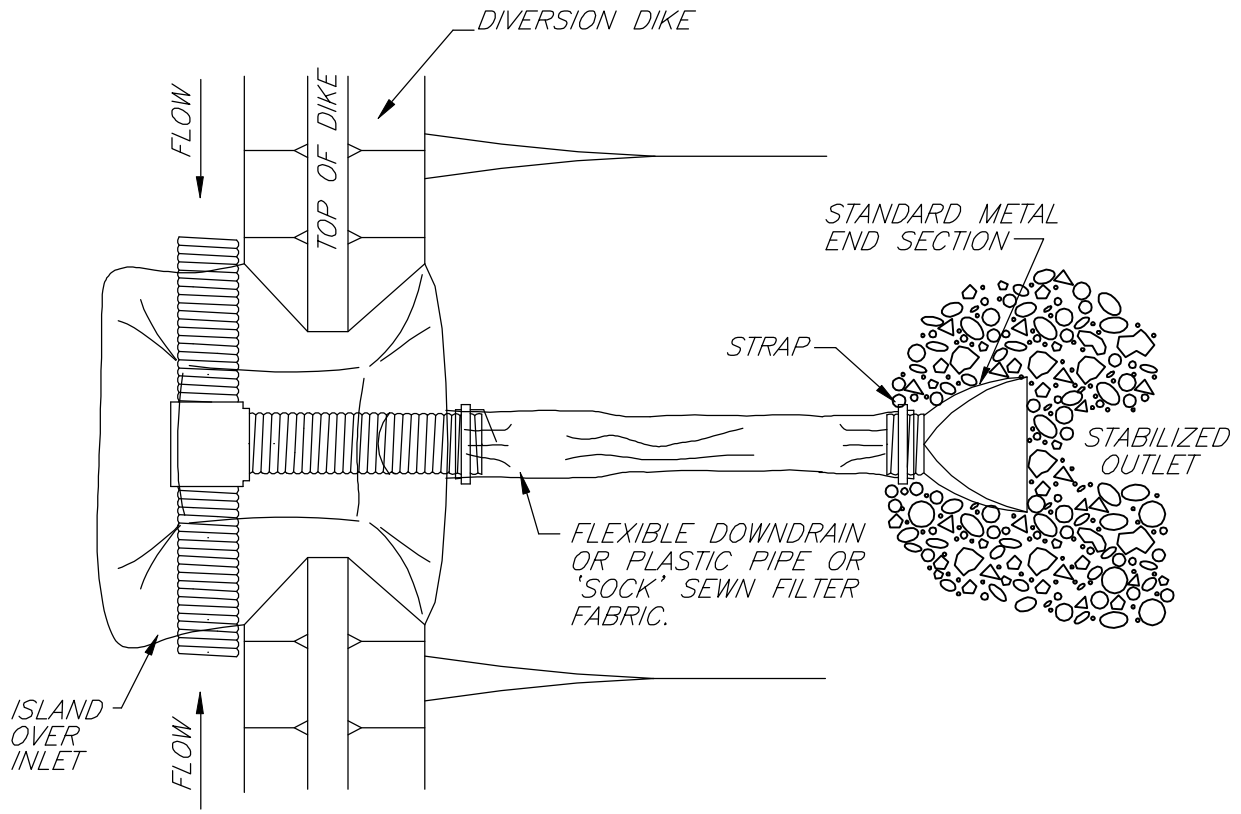

PLAN VIEW

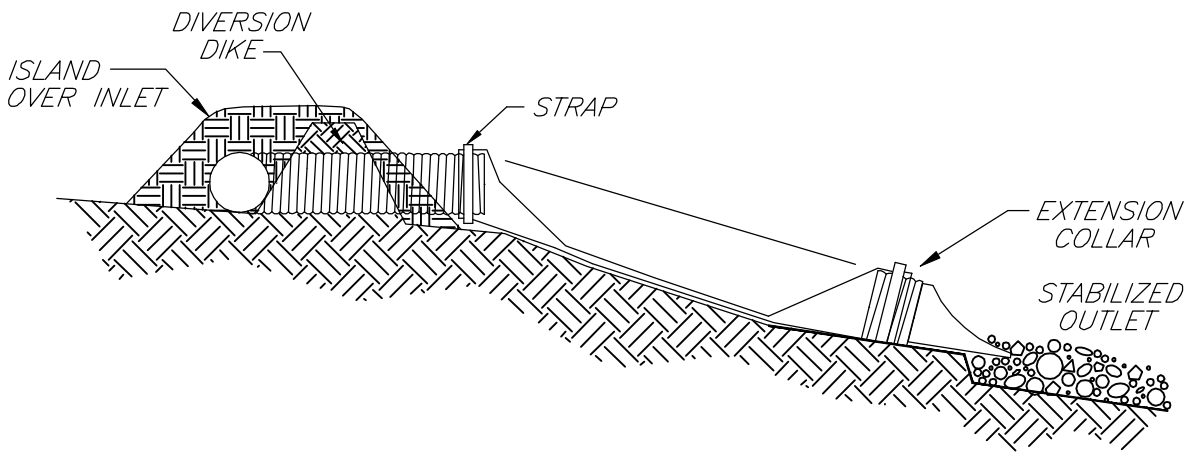

SECTION

NOTE:

1. THIS FIGURE IS PROVIDED FOR GUIDANCE ONLY AND DOES NOT CONSTITUTE A DESIGN. A SITE SPECIFIC DESIGN IS REQUIRED FROM DESIGNER/ENGINEER.

SLOPE DRAIN

From: Salix-Applied Earthcare - EROSION DRAW 3.0
1994 JOHN McCULLAH



FILE: SLOPEDRN

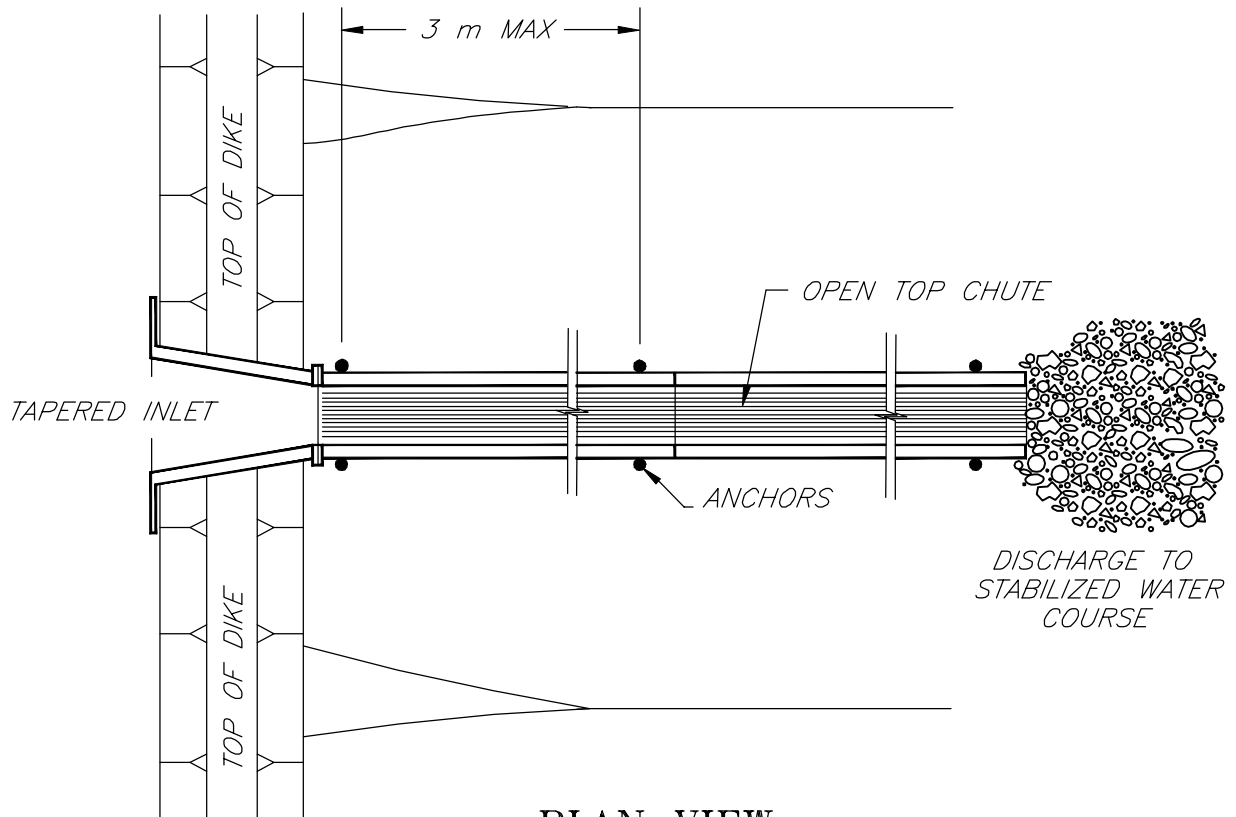

PLAN VIEW

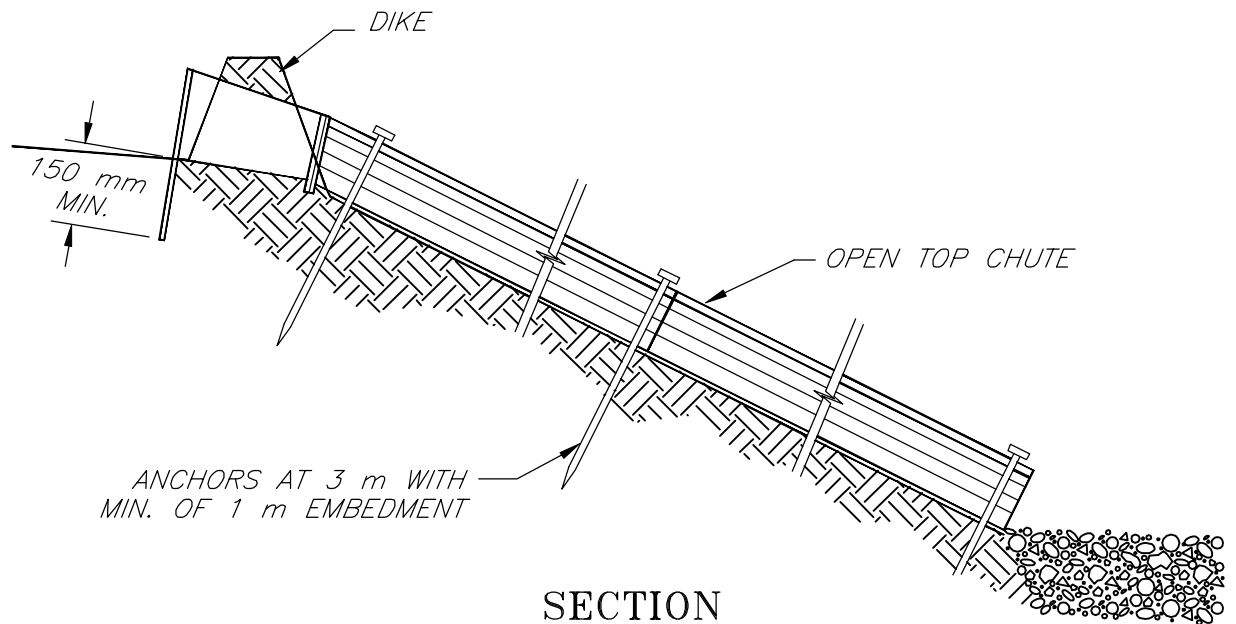

SECTION

NOTE:

1. THIS FIGURE IS PROVIDED FOR GUIDANCE ONLY AND DOES NOT CONSTITUTE A DESIGN. A SITE SPECIFIC DESIGN IS REQUIRED FROM DESIGNER/ENGINEER.

OVERSIDE DRAIN

From: Salix-Applied Earthcare - EROSION DRAW 3.0
1994 JOHN McCULLAH



FILE: OSDRAIN

| | |
|---|-------------------|
| Groundwater Control (Subsurface Drains or Finger Drains) Sediment Control | B.M.P. #20 |
|---|-------------------|

Description and Purpose

- Drains that intercept and collect subsurface groundwater and divert it from slope, thus lowering groundwater table to minimize piping erosion reducing seepage flow on slopes and increase slope stability
- Relief drains (perforated finger-drains or French drains) to mitigate high groundwater table to minimize piping erosion

Applications

- Permanent measure
- Used on cutslopes where groundwater seepage exits on slope face

Limitations

- Must be designed by a geotechnical engineer
- Can be expensive to install
- Plugging of drainage outlet can be detrimental to cause build-up of pore pressure; it is mandatory to protect the outlet area to ensure free draining condition

Construction

- Excavate trench at subsurface drain location
- Install drain pipe
- Backfill with clean, coarse drainage gravel and/or non-woven geotextile fabric to provide filtration separation with adjacent soils

Construction Considerations

- When signs of seepage and unstable excavation slope are encountered at excavations, it is advisable to install trench protection measures for safety (i.e., trench box)
- Carry out work as soon as possible to mitigate seepage damage, soil loss and deterioration of unstable slope
- Excavate and install drains to the grade and spacings according to design and recommendations made by the geotechnical engineer
- Protect outlet of drainage with sturdy pipe to ensure free draining condition
- Drains and pipes should be designed with frost penetration and the freezing of pipes in mind

| | |
|---|------------|
| Groundwater Control (Subsurface Drains or Finger Drains) Sediment Control | B.M.P. #20 |
|---|------------|

Inspection and Maintenance

- Drains installed below grade will require manhole at frequent intervals (100 m maximum) to facilitate inspection and maintenance
- Flushing and maintenance clean out of drains can be carried out through manhole locations

Offtake Ditch (Intercept Ditch)

Erosion Control

B.M.P. #21

Description and Purpose

- Channels or swales commonly located along the crest of cuts slopes to intercept and convey runoff away from flowing down a newly excavated bare soil slope and to minimize erosion of slope from overlanding sheet flow
- Can be tied to outfall to slope drains (or downdrains) which carry water from higher slope elevations to lower elevation of a slope

Applications

- Permanent measure
- Effective method of intercepting runoff to avoid excessive sheet flow over slope and causing erosion, especially on cut slopes in highly erodible soils (sand and silt)
- Can be used in conjunction with slope drains which was installed down a large cut slope
- May be lined with vegetation, rip rap, erosion control blankets, or some other erosion protection measure, but this requirement may be appropriate only at highly sensitive and high risk environmental areas
- Can be used in conjunction with sediment control measures, such as check structures or permeable synthetic barriers as normal channel design, but this requirement may be appropriate only at highly sensitive and high risk environmental areas

Limitations

- Ditch may require lining to minimize soil erosion from concentrated flow
- Ditch may require design by qualified personnel if flow velocities and/or volumes are large
- Channel must be graded to maintain adequate depth, positive drainage to avoid ponding and breaching of channel flow, which may lead to overtopping of the channel to result flow to cause in downslope erosion
- Removal of sediment build up and ditch maintenance may be difficult due to limited access space as offtake ditches are commonly constructed at crest of slopes

Construction

- Use backhoe to form ditch a minimum offset distance of 2 m between crest of highway slope and top of offtake ditch sideslope, thus providing a dyke width of 1 m
 - Place and compact excavated soil to form a dyke between crest of highway slope and offtake ditch channel to provide adequate depth (1 m) of the offtake ditch

| | |
|--|------------|
| Offtake Ditch (Intercept Ditch) Erosion Control | B.M.P. #21 |
|--|------------|

- The consequence of failure on this dyke will determine the level of compaction effort required
- Sideslopes of ditch should not be steeper than 2H:1V (depending upon material type)
- Depth of ditch (from base of ditch to top of embankment) should be a minimum of 1 m in depth; width of ditch should be 1 m minimum
- Ditch grade should be graded a minimum of 1% to promote positive drainage and outfall

Construction Considerations

- Channel should be graded towards nearest outfall (draw) or drainage pipe

Inspection and Maintenance

- Inspection frequency should be in accordance with the PESC and TESC Plans
- Repair any damage to channel immediately

Similar Measures

- Berms
- Barriers

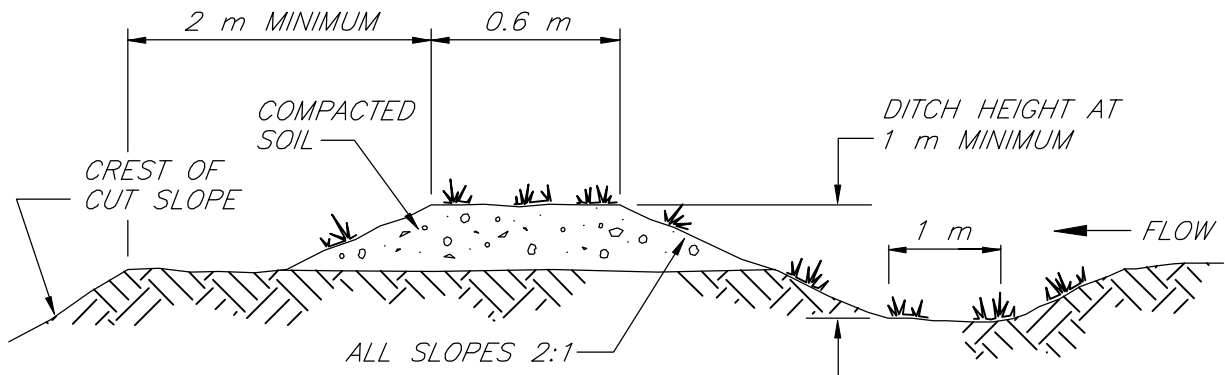

TYPICAL OFFTAKE DITCH

NOTES:

1. THE DITCH BEHIND THE DYKE SHALL HAVE POSITIVE GRADE TO A STABILIZED OUTLET.
2. THE DYKE SHALL BE ADEQUATELY COMPACTED TO PREVENT FAILURE.
3. FOR SENSITIVE HIGH RISK AREAS, THE DITCH SHALL BE STABILIZED WITH TEMPORARY OR PERMANENT SEEDING OR RIPRAP.
4. THIS FIGURE IS PROVIDED FOR GUIDANCE ONLY AND DOES NOT CONSTITUTE A DESIGN. A SITE SPECIFIC DESIGN IS REQUIRED FROM DESIGNER/ENGINEER.

OFFTAKE DITCH
(INTERCEPT DITCH)

| | |
|-----------------|------------|
| Seeding | B.M.P. #22 |
| Erosion Control | |

Description and Purpose

- The planting or placing seed into soils of cut slope or fill embankment slopes after a layer of organic topsoil is spread over the slope
- Provides erosion protection through development of a shallow root structure from seed germination and plant growth

Applications

- Permanent or temporary measure
- Temporary seeding with rapidly growing plants may be applied to interim stockpile/excavation areas which will be exposed for more than 30 days
- Permanent seeding may be applied to exposed bare soil areas which have been graded to final contours
- Permanent seeding may be applied to landscape corridors, slopes and channels by broadcasting, furrowing or spraying on with mulch tackifier
- Provides habitat for wildlife after vegetation establishment
- Can be enhanced with a protective layer of mulches or rolled erosion control products (RECPs) to improve growth environment

Advantages

- Enhances terrestrial and aquatic habitat with vegetation growth re-establishment
- Aesthetically pleasing with vegetation cover
- Grows stronger with time as root structure develops
- Generates vegetation to enhance infiltration of runoff and transpiration of groundwater
- Seeding with a mixture of grasses and herbaceous legumes in disturbed areas is an inexpensive method of stabilizing the soil, particularly if the area is flat to gently sloping
- Cost of seeding disturbed areas is relatively low and its effectiveness on a long-term basis is relatively high

Limitations

- Grasses may require regular maintenance (mowing) along ditches
- Uncut dry grass may present a fire hazard and site distance obstruction adverse to highway safety

Seeding

Erosion Control

B.M.P. #22

- Seeding of steep slopes may be difficult without using measures such as RECP's or hydroseeding-hydromulching methods
- Seasonal windows on planting (early spring or fall) may not coincide favourably with construction schedule
- Areas that have not been covered with seeded topsoil are susceptible to erosion until vegetation is established if RECPs are not used
- Use of topsoil and mulch can reduce rain drop erosion potential during germination and until vegetation is established
- Additional erosion control measures, such as RECPs, may be required for steep slopes and channels
- Reseeding will be required in areas of limited plant growth
- Time to establish root structure may be unacceptable for some high risk areas; shallow sodding should be considered for these areas

Construction

- The site to be seeded should be prepared prior to seeding
- Surface should be graded to design grades and then topsoiled
- Seedbed should be 75 to 150 mm deep, with the top 75 mm consisting of topsoil free of large clods or stones
- Seed should be applied immediately after seedbed preparation using broadcast seed spreaders, cyclone (broadcast) spreaders, or seed drills to ensure uniformity of application
- Seedbed should be harrowed, raked, or chain-dragged to ensure proper seed-soil contact
- Fertilizer should then be applied after seeding

Construction Considerations

- Seeding rate for all mixes should be 25 kg/ha minimum
- Fall rye may be added to each mix to provide early growth and protection from soil erosion.
- Fall rye seeding rate is 5 kg/ha
- Selection of proper vegetation seed mix depends on soil conditions, climate conditions, topography, land use, and site location

Seeding

Erosion Control

B.M.P. #22

- Planting of seeds by hydraulic seeding and mulching techniques should be considered for slopes steeper than 3H:1V where seedbed preparation is difficult, or where application of seed, mulch, and fertilizer in one continuous operation is desirable
- Sod may be installed for faster results, however it is very costly but essential for high risk sensitive areas
- If mulch is placed as a germination medium for seeds, the mulch layer may be further protected with a biodegradable matting to prevent mulch from being washed or blown away

Inspection and Maintenance

- Inspection frequency should be in accordance with the PESC and TESC Plans
- Freshly seeded areas should be inspected frequently to ensure growth is progressing
- Additional stormwater control measures should be considered for areas damaged by runoff
- Reseedings may be required within 1 to 5 year intervals after initial seeding
- Small bare spots may need to be reseeded several times at subsequent years after initial application
- Larger areas may need to be completely retreated
- Cutting or mowing grasses will encourage the establishment and spread of the grass

Similar Measures

- Hydraulic seeding and mulching
- Sodding

Design Considerations

- Seed application rate of 25 kg/ha may be used; if fall rye is to be added, it should have an application rate of 5 kg/ha
- When using a seed drill or Brillion seeder, grasses and legumes shall not be planted deeper than 1 cm
- Bacterial inoculants must be used when seeding with legumes
- A specific inoculant shall be used for the legume being seeded in accordance with the supplier's recommendations

| | |
|----------------------------|------------|
| Seeding Erosion Control | B.M.P. #22 |
|----------------------------|------------|

- Fertilizer, in lieu of a soil test, shall be as stated in the design, or follow supplier's recommendations
- Fertilizer shall be applied at a rate of 50 to 75 kg of nitrogen/ha, depending upon site conditions
- Fertilizer use shall be carefully controlled as this may increase nutrient loading to receiving streams if runoff is not controlled properly
- Seeding shall occur during periods when germination can be successful and plants have sufficient time to become established before the end of the growing season (approximately May 15 to June 1 and/or August 15 to September 15)
- Seeding should not occur after the 50% frost probability date for the site
- Mulch is required when broadcast seeding or if seeding is carried out after the date specified in which fall seeding should not be carried out
- For specific needs of local growth environment, specific design and advice from local seed supplier or Professional Agrologist may be required

Alberta Transportation has adopted seed mixes (provided below) depending on site location. The various areas of the province used in selecting the seed mix are presented (Alberta Transportation Seed Mixture Zones Map).

| | |
|--------------------------------|------------|
| Seeding Erosion Control | B.M.P. #22 |
|--------------------------------|------------|

**Alberta Transportation
Grass Seed Mixtures used on Highway and Bridge Projects**

This Special Provision (Spc_G039.wpd (2005)) is to be used in conjunction with AT Standard Specification 2.20 "Seeding" and Design Bulletin No. 25. The Consultant must perform the vegetation assessment and the soil testing for fertilizer (if required) as part of his design work.

Zone 1 - Peace River District - north and west of High Level:

| Seed Mix Zone | Native Seed Mix - Zone 1 | | % by Dry Weight |
|---------------------------|------------------------------|-------------------------------|-----------------|
| | Common Name | Latin Name | |
| 1 Wetland Mixedwood | Slender Wheat Grass | <i>Agropyron trachycaulum</i> | 40% |
| | Fringed Brome ⁽¹⁾ | <i>Bromus ciliatus</i> | 15% |
| | Tufted Hairgrass | <i>Deschampsia cespitosa</i> | 15% |
| | Northern Wheat Grass | <i>Agropyron dasystachyum</i> | 10% |
| | Rocky Mountain Fescue | <i>Festuca saximontana</i> | 10% |
| | Fowl Bluegrass | <i>Poa palustris</i> | 10% |

Note ⁽¹⁾: Fringed Brome seed shall be coated.

| Agronomic Seed Mix - Zone 1 | | |
|-----------------------------|-------------------------------|-----------------|
| Common Name | Latin Name | % by Dry Weight |
| Pubescent Wheat Grass | <i>Agropyron trichophorum</i> | 40% |
| Dahurian Wildrye | <i>Elymus dahuricus</i> | 22% |
| Sheep Fescue | <i>Festuca ovina</i> | 30% |
| Perennial Ryegrass | <i>Lolium perenne</i> | 8% |

Zone 2 - Athabasca District (south of Athabasca) and Grande Prairie District

| Seed Mix Zone | Native Seed Mix - Zone 2 | | % by Dry Weight |
|-----------------------|------------------------------|-------------------------------|-----------------|
| | Common Name | Latin Name | |
| 2 Dry Mixedwood | Slender Wheat Grass | <i>Agropyron trachycaulum</i> | 35% |
| | Fringed Brome ⁽¹⁾ | <i>Bromus ciliatus</i> | 20% |
| | Tufted Hairgrass | <i>Deschampsia cespitosa</i> | 10% |
| | Northern Wheat Grass | <i>Agropyron dasystachyum</i> | 15% |
| | Rocky Mountain Fescue | <i>Festuca saximontana</i> | 10% |
| | Fowl Bluegrass | <i>Poa palustris</i> | 10% |

Note ⁽¹⁾: Fringed Brome seed shall be coated.

| | |
|----------------------------|------------|
| Seeding Erosion Control | B.M.P. #22 |
|----------------------------|------------|

| Agronomic Seed Mix - Zone 2 | | |
|-----------------------------|-------------------------------|-----------------|
| Common Name | Latin Name | % by Dry Weight |
| Pubescent Wheat Grass | <i>Agropyron trichophorum</i> | 40% |
| Dahurian Wildrye | <i>Elymus dahuricus</i> | 22% |
| Sheep Fescue | <i>Festuca ovina</i> | 30% |
| Perennial Ryegrass | <i>Lolium perenne</i> | 8% |

Zone 3 - Athabasca District (north of Athabasca) and Hwy. Nos. 88, 750, 986

| Seed Mix Zone | Native Seed Mix - Zone 3 | | % by Dry Weight |
|---------------------------|------------------------------|-------------------------------|-----------------|
| | Common Name | Latin Name | |
| 3 Central Mixedwood | Slender Wheat Grass | <i>Agropyron trachycaulum</i> | 35% |
| | Fringed Brome ⁽¹⁾ | <i>Bromus ciliatus</i> | 10% |
| | Tufted Hairgrass | <i>Deschampsia cespitosa</i> | 10% |
| | Canada Wildrye | <i>Elymus canadensis</i> | 10% |
| | Rocky Mountain Fescue | <i>Festuca saximontana</i> | 20% |
| | Tickle Grass | <i>Agrostis scabra</i> | 10% |
| | Fowl Bluegrass | <i>Poa palustris</i> | 5% |

Note ⁽¹⁾: Fringed Brome seed shall be coated.

| Agronomic Seed Mix - Zone 3 | | |
|-----------------------------|-------------------------------|-----------------|
| Common Name | Latin Name | % by Dry Weight |
| Pubescent Wheat Grass | <i>Agropyron trichophorum</i> | 40% |
| Dahurian Wildrye | <i>Elymus dahuricus</i> | 22% |
| Sheep Fescue | <i>Festuca ovina</i> | 30% |
| Perennial Ryegrass | <i>Lolium perenne</i> | 8% |

| | |
|--|-------------------|
| Seeding Erosion Control | B.M.P. #22 |
|--|-------------------|

Zone 4 - Lethbridge District (east of Hwy 22), Calgary District (east of Hwy 22), and Hanna District

| Seed Mix Zone | Native Seed Mix - Zone 4 | | % by Dry Weight |
|---|--------------------------|-------------------------------|-----------------|
| | Common Name | Latin Name | |
| 4 Mixedgrass and Dry Mixedgrass | Slender Wheat Grass | <i>Agropyron trachycaulum</i> | 30% |
| | Canada Wildrye | <i>Elymus canadensis</i> | 15% |
| | Mountain Brome | <i>Bromus carinatus</i> | 15% |
| | Northern Wheat Grass | <i>Agropyron dasystachyum</i> | 10% |
| | Western Wheat Grass | <i>Agropyron smithii</i> | 5% |
| | Indian Rice Grass | <i>Orzyopsis hymenoides</i> | 5% |
| | Alkali Grass | <i>Puccinellia distans</i> | 10% |
| | Needle and Thread Grass | <i>Stipa comata</i> | 10% |

| Agronomic Seed Mix - Zone 4 | | |
|-----------------------------|-------------------------------|-----------------|
| Common Name | Latin Name | % by Dry Weight |
| Pubescent Wheat Grass | <i>Agropyron trichophorum</i> | 32% |
| Dahurian Wildrye | <i>Elymus dahuricus</i> | 30% |
| Sheep Fescue | <i>Festuca ovina</i> | 30% |
| Cereal Rye | <i>Secale cereale</i> | 8% |

Zone 5 - Stony Plain, Vermillion, and Red Deer (east of Hwy 22) Districts:

| Seed Mix Zone | Native Seed Mix - Zone 5 | | % by Dry Weight |
|--------------------------|------------------------------|--------------------------------|-----------------|
| | Common Name | Latin Name | |
| 5 Central Parkland | Slender Wheat Grass | <i>Agropyron trachycaulum</i> | 25% |
| | Northern Wheat Grass | <i>Agropyron dasystachyum</i> | 10% |
| | Fringed Brome ⁽¹⁾ | <i>Bromus ciliatus</i> | 15% |
| | Green Needle Grass | <i>Stipa viridula</i> | 15% |
| | Canada Wildrye | <i>Elymus canadensis</i> | 10% |
| | Indian Rice Grass | <i>Orzyopsis hymenoides</i> | 10% |
| | Nuttall's Alkali Grass | <i>Puccinellia nuttalliana</i> | 10% |
| | Western Wheat Grass | <i>Agropyron smithii</i> | 5% |

Note ⁽¹⁾: Fringed Brome seed shall be coated.

| | |
|-----------------|------------|
| Seeding | B.M.P. #22 |
| Erosion Control | |

| Agronomic Seed Mix - Zone 5 | | |
|-----------------------------|------------------------|-----------------|
| Common Name | Latin Name | % by Dry Weight |
| Pubescent Wheat Grass | Agropyron trichophorum | 32% |
| Dahurian Wildrye | Elymus dahuricus | 30% |
| Sheep Fescue | Festuca ovina | 30% |
| Cereal Rye | Secale cereale | 8% |

Zone 6 -Lethbridge, Calgary, and Red Deer Districts all located west of Hwy 22):

| Seed Mix Zone | Native Seed Mix - Zone 6 | | % by Dry Weight |
|-------------------------|------------------------------|------------------------|-----------------|
| | Common Name | Latin Name | |
| 6 Lower Foothills | Slender Wheat Grass | Agropyron trachycaulum | 30% |
| | Smooth Wildrye | Elymus glaucus | 20% |
| | Northern Wheat Grass | Agropyron dasystachyum | 10% |
| | Tickle Grass | Agrostis scabra | 10% |
| | Fringed Brome ⁽¹⁾ | Bromus ciliatus | 10% |
| | Tufted Hairgrass | Deschampsia cespitosa | 10% |
| | Foothills Rough Fescue | Festuca campestris | 10% |

Note ⁽¹⁾: Fringed Brome seed shall be coated.

| Agronomic Seed Mix - Zone 6 | | |
|-----------------------------|------------------------|-----------------|
| Common Name | Latin Name | % by Dry Weight |
| Pubescent Wheat Grass | Agropyron trichophorum | 40% |
| Dahurian Wildrye | Elymus dahuricus | 22% |
| Sheep Fescue | Festuca ovina | 30% |
| Perennial Ryegrass | Lolium perenne | 8% |

Seeding

Erosion Control

B.M.P. #22

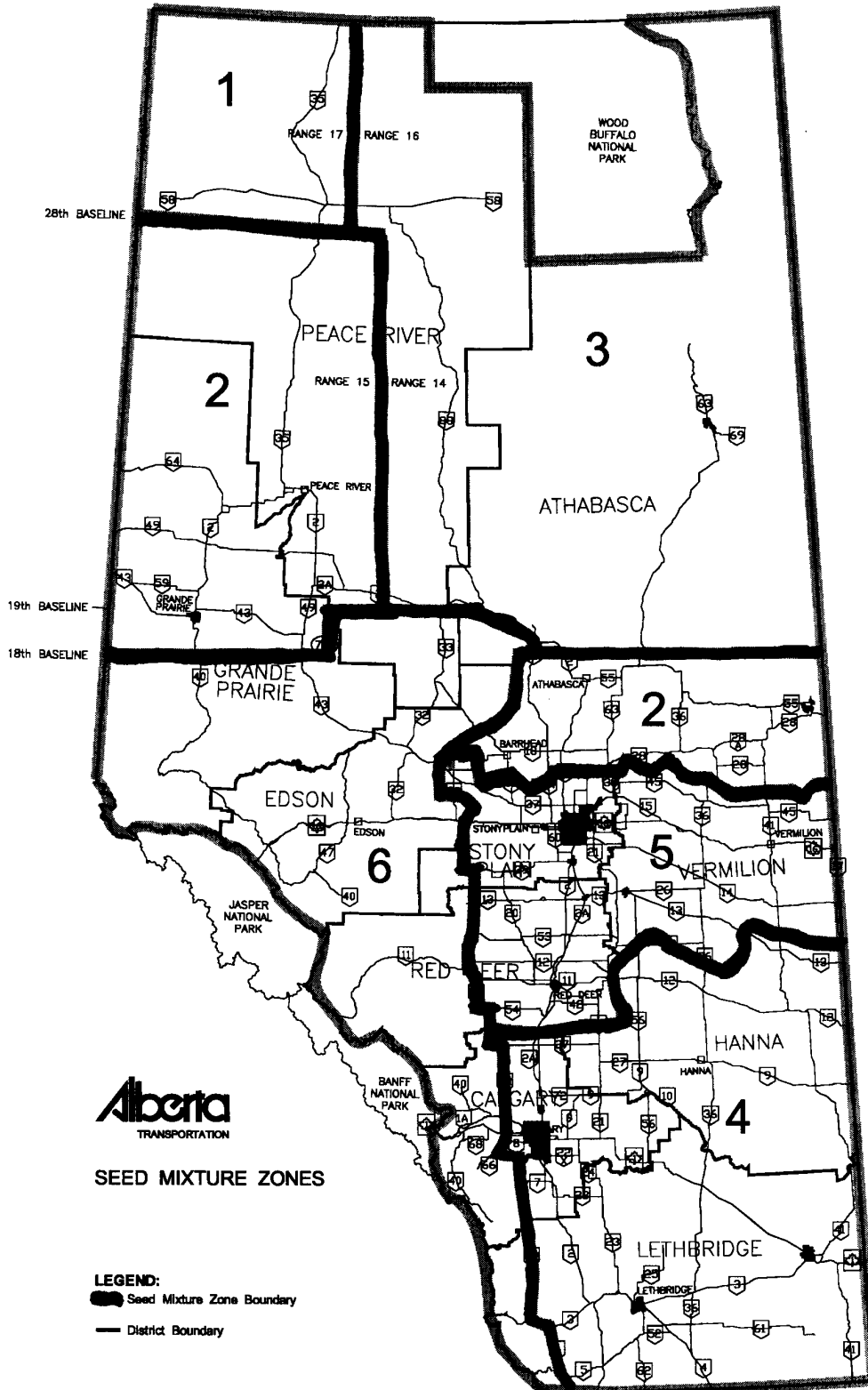

Description and Purpose

- Application of organic material or other normally biodegradable substances as a protection layer to the soil surface (i) to minimize raindrop/runoff erosion and conserve a desirable soil moisture property for plant growth, and/or (ii) to promote seed germination and plant growth
- Mulches conserve soil moisture, reduce runoff velocities and surface erosion, control weeds, help establish plant cover, and protect seeds from predators, raindrop impact, and wind/water erosion

Applications

- Temporary measure
- Can be used as an organic cover or growth medium for seeds where topsoil is not readily available
- Can be used to provide temporary and permanent erosion control
- May be used with or without seeding in areas that are rough graded or final graded
- May be applied in conjunction with seeding to promote plant growth
- May comprise organic mulches (such as straw, wood fibres, peat moss, wood chips, pine needles, compost) or chemical mulches (such as vinyl compounds, asphalt, rubber, or other substances mixed with water)
- Chemical mulches may be used to bind other mulches in a hydroseeding-hydromulching application

Advantages

- Relatively cheap method of promoting plant growth and slope protection

Limitations

- Application of mulch may be difficult on steep slopes
- May require spray-on method to apply mulch with tackifier to provide adhesion to steep slopes

Installation

- Prepare soil surface by removing large rocks or other deleterious materials
- Apply topsoil and seed, if required, and if topsoil is readily available
- Apply mulch as per supplier's recommendations

- Certain mulches may require additional anchoring to minimize loss of mulch due to wind or water erosion

Construction Considerations

- Install mulches as per manufacturers' or suppliers' recommendations
- Organic Mulches
 - Straw
 - Refers to stalks or stems of small grain (primarily wheat) after drying and threshing
 - Straw should be free of weeds
 - Loose straw is very susceptible to movement by blowing wind and water runoff and should be anchored either with chemical tackifier or some form of netting
 - When properly secured to surface, straw is highly suitable for promoting good grass cover quickly, however, it may be a fire hazard in dry conditions
 - Raw Wood Fibre
 - Mixture of cellulose fibres; a minimum of 4 mm in length extracted from wood
 - Wood fibres usually require a soil binder and should not be used as erosion control during periods of hot dry weather in the summer or for late fall seeding unless it is used in conjunction with another suitable mulch as it is prone to removal by blowing wind or water runoff
 - Wood fibre is primarily used in hydroseeding-hydromulching operations where it is applied as part of a slurry and when used in conjunction with a tackifier; it is well suited for tacking straw mulch on steep slopes
 - Peat Moss
 - Comprises partly decomposed mosses and organic matter under conditions of excessive moisture
 - Usually available in dried and compressed bundles
 - Should be free of coarse material
 - Useful soil conditioner to improve organic content of soil promoting plant growth
 - Highly susceptible to removal by blowing wind and water runoff if dry and spread on top of soil
 - Wood Chips
 - By-products of timber processing comprised of small, thin pieces of wood

- Decompose slowly
- Suitable for placing around individual plants (shrubs and trees) and for areas that will not be closely mowed
- Highly resistant to removal by blowing wind and water runoff
- Bark Chips (Shredded Bark)
 - By-products of timber processing comprised of small, thin pieces of tree bark
 - Suitable for areas that will not be closely mowed
 - Have good moisture retention properties and are resistant to removal by blowing wind and water runoff
- Pine Needles
 - Comprise needles from coniferous trees (pine, spruce)
 - Needles should be air dried and free of coarse material
 - Decompose slowly
 - Suitable for use with plants that require acidic soils
 - Resistant to removal by blowing wind and water runoff
- Compost (Straw Manure)
 - Comprised of organic residues and straw that have undergone biological decomposition until stable
 - Should be well shredded, free from coarse material, and not wet
 - Has good moisture retention properties and is suitable as a soil conditioner promoting plant growth
 - Relatively resistant to removal by blowing wind and water runoff if not dried out completely
- Chemical Mulches
 - Comprised of acrylic co-polymers, vinyl compounds, asphalt, rubber, or other substances mixed with water
 - Usually used in hydroseeding-hydromulching applications
 - Should be applied in accordance with suppliers' recommendations

| | |
|--|------------|
| Mulching Sediment Control and Erosion Control | B.M.P. #23 |
|--|------------|

Inspection and Maintenance

- Inspection frequency should be in accordance with the PESC and TESC Plans
- Areas damaged by washout or rilling should be regraded if necessary and recovered with mulch immediately
- Additional stormwater control measures should be considered for areas of severe rilling erosion damaged by runoff
- Small bare spots may need to be reseeded and recovered with mulch

Similar Measures

- Topsoiling
- Hydraulic seeding and mulching (hydroseeding, hydromulching)
- Rolled erosion control products (RECP)

Description and Purpose

- The spraying-on of a slurry to a slope or channel surface to provide a layer of seed and growth bedding medium
- The slurry consists of seed, fertilizer, mulch, tackifiers, and water which are mixed together in a tank
- Enables quick re-vegetation of very steep or rocky/gravelly slopes where re-vegetation by any other method would be very difficult or unsafe; frequent re-seeding and special mix design may be required
- When sprayed on the soil, the slurry forms a continuous blanket with seeds and protects the soil from wind and water erosion and raindrop impact by aggregating (or adhering) them in place
- The slurry conserves moisture, reduces soil moisture evaporation, and decreases soil surface crusting due to evaporation or drying of soil

Applications

- Temporary measure
- Slurry is held in suspension through consistent agitation and is sprayed onto disturbed areas using high pressure pumps
- Can be used for spray-on seeding covering large areas efficiently after placement of topsoil
- Can be used to provide temporary and permanent erosion control prior to establishment of vegetation
- May be used to provide soil stabilization for seeding disturbed soil areas
- Can also be used with higher efficiency and large area coverage with advantages over conventional methods (broadcast seeders, drill seeders)
- Can be used in areas where little topsoil is available

Limitations

- Site must be accessible to hydroseeding equipment
 - Usually mounted on trucks
 - Maximum hose range of approximately 150 m
- May require subsequent spraying to reseed bare spots or areas with low growth

Hydroseeding

Sediment Control and Erosion Control

B.M.P. #24a

Construction

- Prepare soil surface by removing large rocks or other deleterious materials
- Apply topsoil if available
- Spray on hydroseed-hydromulch as per supplier's recommendations

Construction Considerations

- Seed
 - Seed selection should be made in accordance with Alberta Transportation approved seed mixes
 - Alberta Transportation has adopted seed mixes used on Alberta Highway and Bridge Projects depending on site location (see BMP #22 Seeding)
 - The various areas of the province used in selecting the seed mix are presented in the Seed Mix Zones map (see BMP #22 Seeding)
 - Seed mixes have been developed based on historic performance results throughout Alberta

Inspection and Maintenance

- Inspection frequency should be in accordance with the PESC and TESC Plans
- Areas damaged by runoff may need to be repaired and/or protected from further erosion
- Small bare spots may need to be reseeded

Similar Measures

- Seeding
- Mulching
- Rolled erosion control products (RECP)

Description and Purpose

- The spraying-on of a slurry to a slope or channel surface to provide a layer of growth bedding medium
- The slurry consists of seed, fertilizer, mulch, tackifiers, and water which are mixed together in a tank
- The slurry conserves moisture, reduces soil moisture evaporation, and decreases soil surface crusting due to evaporation or drying of soil

Applications

- Temporary measure
- Can be used in areas where little topsoil is available

Advantages

- Relatively cheap and efficient spraying method of promoting plant growth as well as erosion protection
- Allows spray-on re-vegetation of steep slopes where conventional re-vegetation methods are very difficult
- Minimizes effort required to re-vegetate disturbed areas as hydromulching usually only requires one spray-on operation in comparison with planting and farrow method
- Relatively efficient operation with high coverage rates
- Provides dust control and protection from wind erosion

Limitations

- Site must be accessible to hydromulching equipment
 - Usually mounted on trucks
 - Maximum hose range of approximately 150 m

Construction

- Prepare soil surface by removing large rocks or other deleterious materials
- Apply topsoil if available
- Spray on hydromulch as per supplier's recommendations

Construction Considerations

- Hydraulic Mulches
 - Cellulose
 - Comprised of recycled paper from newspapers, magazines, or other paper sources
 - Rapid method for applying seed, fertilizer, mulch, and water in almost any disturbed areas
 - Usually installed without tackifier in slurry
 - Short fibre lengths and lack of tackifier limits erosion control effectiveness and does little to moderate moisture content and temperature within the soil
 - Residual inks within the recycled paper may leach into soil, potential problem on environmentally sensitive areas
 - Longevity significantly shorter than for wood fibre mulches or bonded fibre matrices (BFM)
 - Cheaper than wood fibre mulches and bonded fibre matrices (BFM)
 - Wood Fibre
 - Comprised of whole wood chips
 - Industry standard, provides quick and uniform method and medium for re-vegetating large areas quickly and economically
 - Longer fibre lengths than for cellulose mulches
 - Longer lasting and has better wet-dry characteristics than cellulose mulches
 - Provides limited erosion control even when sprayed on with tackifiers
 - Provides limited moderation of soil moisture content and temperature when applied at higher rates
 - Cheaper than BFM, however, less effective than BFM
 - More expensive than cellulose mulches, however, more effective than cellulose mulches

– Bonded Fibre Matrices (BFM)

- Slurry comprised of either cellulose mulch, wood fibre mulch, or a combination of the two
 - Mulches are bound together using chemical bond, mechanical bond, or a combination of the two
 - All fibres and binding agents are premixed by manufacturer, ensuring uniformity and consistency throughout the application
 - Well suited for sites with existing desirable vegetation and where worker safety and minimal ground disturbance are desired
 - Degree of protection similar to that obtained from rolled erosion control products (RECP)
 - Quicker installation/application than for RECP
 - Chemically bonded BFM may require a ‘set-up’ or curing/drying period
 - Application must be limited to periods where there is no threat of rain during curing period
 - Mechanically bonded BFM have no curing time and are effective immediately after application
 - Application on dry soils is not recommended
 - More expensive than cellulose and wood fibre mulches
 - More effective than cellulose or wood fibre mulches
- Tackifiers
 - May include vinyl compounds, asphalt, rubber, or other substances mixed with water

Inspection and Maintenance

- Inspection frequency should be in accordance with the PESC and TESC Plans
- Areas damaged by runoff may need to be repaired and/or protected from further erosion.

Similar Measures

- Seeding
- Mulching
- Rolled erosion control products (RECP)

| | |
|-------------------------------|------------|
| Topsoiling Erosion Control | B.M.P. #25 |
|-------------------------------|------------|

Description and Purpose

- The covering of exposed mineral soils with soils of high organic content to minimize raindrop erosion potential
- Provides a medium for vegetation to grow

Applications

- Temporary or permanent measure
- May be used to provide a bedding medium for seed germination and a cover to exposed soil that is not suitable to promote vegetation growth
- May be used on slopes with a maximum gradient of 2H:1V
- Normally topsoil is placed prior to seeding, mulching, hydroseeding-hydromulching, seeding and installing rolled erosion control products (RECP), or planting of trees/shrubs

Advantages

- Placing topsoil provides enriched organic medium for vegetation root structure to grow
- Topsoil organic content provides nutrients to promote plant growth
- Absorb raindrop energy to reduce erosion

Limitations

- Not appropriate for slopes steeper than 2H:1V
- Placing and grading topsoil can be time consuming and expensive
- Dry topsoil may be removed by blowing wind
- Topsoil may not be readily available in some areas

Construction

- Prepare ground surface to final grade by removing large rocks or other deleterious materials
- Apply topsoil with dozer or light track equipment to design thickness
- Track walk upslope or downslope (do not overcompact topsoil by heavy equipment; only track walk one pass) to provide a contour of roughness of topsoil to further minimize erosion

| | |
|-----------------|------------|
| Topsoiling | B.M.P. #25 |
| Erosion Control | |

Construction Considerations

- Topsoil should be free of weeds which may inhibit re-vegetation of desirable plants (i.e., grass)
- Subgrade should be roughened by track walking up/down the slope prior to topsoiling to promote adhering of topsoil to subgrade (surface roughening of subgrade is especially required if topsoiling is not scheduled immediately after completion of the grade)
- Topsoil should be moistened regularly during periods of hot dry weather to minimize wind erosion
 - Hydroseeding-hydromulching topsoil will minimize wind erosion of topsoil

Design Considerations

- Perform pre and post disturbance survey
- Consider use of a soil mimic in areas with little topsoil or topsoil with poor growth nutrients
- Perform a preconstruction topsoil assessment to determine topsoil thickness hence design thickness

Inspection and Maintenance

- Inspection frequency should be in accordance with the PESC and TESC Plans
- Areas damaged by washout or rilling should be regraded and re-topsoiled immediately

Similar Measures

- Hydroseeding-hydromulching
- Mulching
- Rolled erosion control products (RECP)

| | |
|-----------------|------------|
| Sodding | B.M.P. #26 |
| Erosion Control | |

Description and Purpose

- Use of grass sod to cover and stabilize disturbed areas of bare soil
- Rapidly establishes vegetative cover in environmentally sensitive areas where complete cover of the disturbed soil surface is essential and conventional or hydroseeding and mulching may not be effective to erosion protection for high risk areas
- Acts as a vegetative buffer
- Sod may be nursery or field sod composed of one or more species/cultivars of grasses and may contain associated plants such as legumes

Applications

- Temporary or permanent measure
- Irrigation (watering) required after placement
- May be used to protect soil surface from water and wind erosion where adequate topsoil and fertilizer can be provided
- Best used for areas that have steep grades or require immediate protection, or at locations where aesthetic appearance is a priority

Advantages

- Immediate protection for sensitive area from water and wind erosion
- Aesthetically pleasing

Limitations

- Expensive
- Labour intensive to install
- Sod may not be readily available in all areas of the province
- Field sod is not specifically produced for sale as turf and is generally not certified as to its composition or degree of weed infestation
- Sod can't be stored on-site for long periods of time

Construction

- Prepare smooth ground surface by removing large rocks or other deleterious materials
- Apply design thickness of topsoil and fertilizer (if required)

- Lay sod strips on prepared surface with long axis perpendicular to direction of slope (or in channels, perpendicular to anticipated direction of flow)
 - Butt-joint ends of adjacent sod strips tightly together
 - Roll or tamp each sod strip to ensure continuous contact between topsoil and underside of sod strip
 - Secure each strip of sod with an anchor embedded a minimum of 0.15 m into underlying soil
 - Anchors should be spaced a maximum distance of 0.6 m apart
- Adjacent rows of sod strips should have staggered joints

Construction Considerations

- Sod must not be placed on frozen ground
- During hot and dry periods, topsoil should be cool and wetted by irrigation prior to placing sod strips
- Freshly installed sod should be irrigated (watered) to moisten the topsoil to minimum depth of 0.1 m
 - Irrigation aids in the development of root matrix within the topsoil
- Successful installation requires the use of freshly cut, healthy sod
 - Storage time of cut sod on-site prior to installation should be kept to as short a time period as possible

Inspection and Maintenance

- Inspection frequency should be in accordance with the PESC and TESC Plans
 - Areas damaged by washout or rilling should be regraded and resodded immediately
- Additional erosion control measures should be considered for rilled or gullied areas
- Small bare spots may need to be resodded
- Sodded areas should be maintained by periodically fertilizing, irrigating (watering), mowing, and weed control, depending on location and maintenance plan
- Sod that is to be mowed periodically as part of its maintenance plan should not be mowed within one month of installation
- Grass clipping from mowing operations should be left on the sod unless they accumulate to a depth greater than 1 cm

| | |
|-----------------|------------|
| Sodding | B.M.P. #26 |
| Erosion Control | |

Similar Measures

- Mulching
- Hydroseeding
- Hydromulching
- Rolled erosion control products (RECP)

Description and Purpose

- Consists of installing woody plantings (trees and shrubs) to develop a root matrix within the soil, increasing subsurface soil strength and stabilizing slopes with deeper root systems than grasses
- Reduces erosion potential of slopes and channel banks

Applications

- Temporary or permanent measure
- May be used on slopes stable enough to support vegetation; however, there is a low success rate for steep slopes and channel banks with gradients greater than 1H:1V
- May be used on slopes and channel banks with adequate sunlight, moisture, and wind protection to support vegetation
- May be used as bio-engineering stabilization in cases where there have been historical shallow slope instability, soil movements on eroded slopes and gullies
- May be used along channels to provide higher channel roughness to reduce flow velocity and in sedimentation ponds to provide higher sedimentation duration of runoff impoundment

Advantages

- Promotes development of organic mat
- Dense leaves and large diameter plant stalks increases channel roughness and reduces flow velocities in channel thus decreasing erosion potential
- Traps sediment laden runoff and stabilizes soil
- Aesthetically pleasing once developed
- Grows stronger with time as root structure develops
- Usually has deeper root penetration than grass with greater depth of stabilization
- Manual planting may be attempted on steep slopes that are sensitive to machinery disturbance or represent an area of high erosion potential

Limitations

- Can be labour intensive to install
- Some level of uncertainty as success of plant growth is dependent on various unknown site parameters (i.e., moisture, soil, terrain, weather, seeding conditions, etc.)
- Re-vegetated areas are susceptible to erosion until vegetation develops; and should be used in conjunction with hydroseeding and/or mulching
- Plants may be damaged by wildlife
- Potential for low success rate
- Few precedents as this measure is generally not used on AT construction projects

Construction

- Used on cut or fill slopes or in ditches/channels
- Comprised of willow or poplar stakes inserted into the ground; other indigenous plants may be acceptable
- Individual dormant willow or poplar stakes should be cut to a minimum length of 0.5 m using pruning shears
 - Cuts should be made at a 45° angle a minimum of 0.05 m (5 cm) below a leaf bud
 - All side shutes should be trimmed to within 0.05 m of the main stem
- Install live stakes in a 1 m by 1 m grid
- Make a pilot hole a minimum of 0.3 m in depth to insert live stake into
 - Use iron bar, broom handle or other tool to make pilot hole
- Insert live stake into pilot hole and lightly tamp soil around live stake
- A minimum of two leaf buds should remain above grade

Construction Considerations

- Successful installation requires the use of freshly cut branches or stakes
 - Storage time of cut branches/stakes on-site prior to installation should be kept to as short a time period as possible
- Successful growth dependant on soil moisture and rainfall conditions
- Consultation with agrologist, greenhouse growers, local expertise can be beneficial in selecting and procuring appropriate species for planting

| | |
|--|-------------|
| Live Staking Streambank Stabilization Technique | B.M.P. #27a |
|--|-------------|

Inspection and Maintenance

- Inspection frequency should be in accordance with the PESC and TESC Plans
 - Areas damaged by washout or erosion rilling should be replanted immediately
- Additional stormwater control measures should be considered for severe rilling areas damaged by runoff
- Watering plants is required for first one to two months after planting

Similar Measures

- Seeding
- Mulching
- Hydroseeding
- Hydromulching
- Rolled erosion control products (RECP)
- Brush layering

TYPICAL USE OF WILLOW STAKES TO ANCHOR WILLOW WATTLES, STRAW ROLLS, BIO MATS, OR TURF REINFORCEMENT MATS

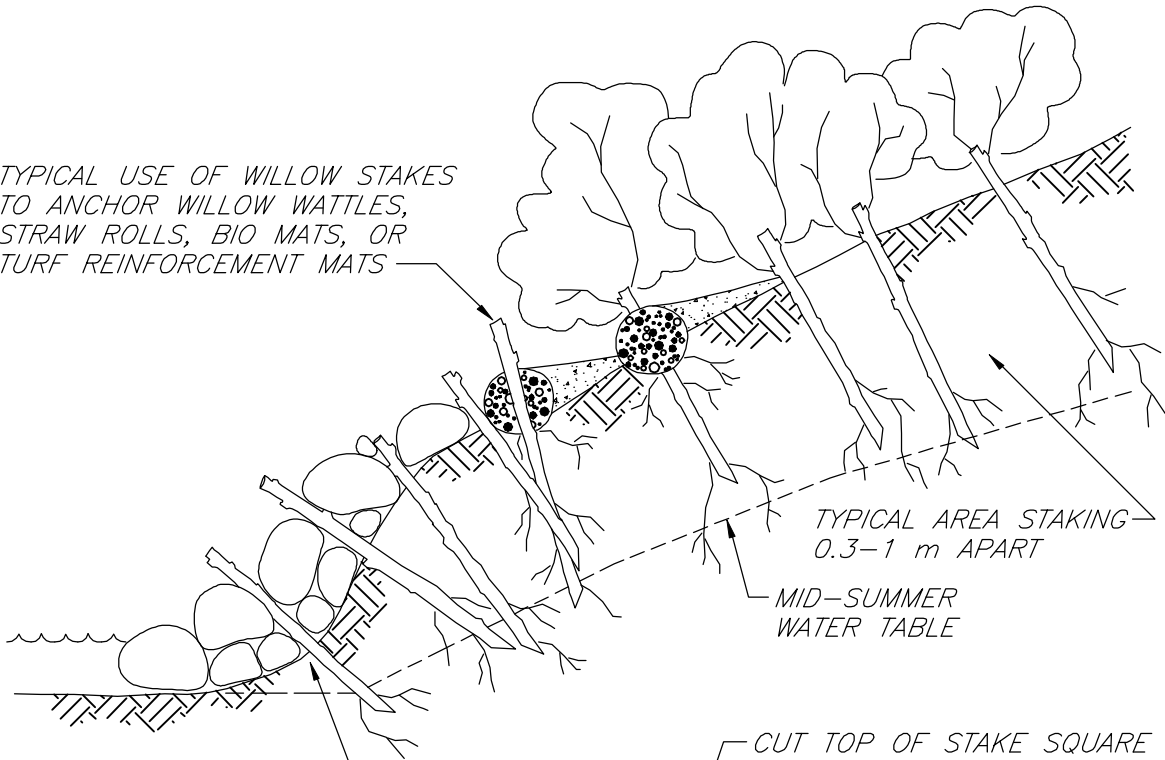

TYPICAL AREA STAKING
0.3-1 m APART

MID-SUMMER
WATER TABLE

TYPICAL - DRIVE OR PLANT WILLOW STAKES THROUGH OPENINGS IN RIPRAP OR GABIONS

PLANT 80% OF STAKE LENGTH INTO THE GROUND

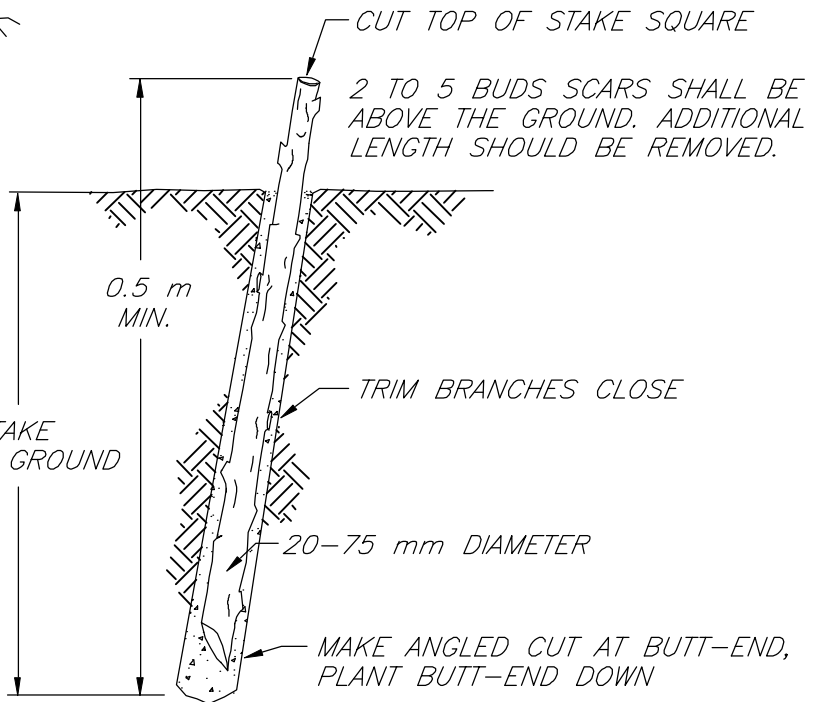

CUT TOP OF STAKE SQUARE

2 TO 5 BUDS SCARS SHALL BE ABOVE THE GROUND. ADDITIONAL LENGTH SHOULD BE REMOVED.

0.5 m
MIN.

TRIM BRANCHES CLOSE

20-75 mm DIAMETER

MAKE ANGLED CUT AT BUTT-END, PLANT BUTT-END DOWN

NOTES:

1. HARVEST AND PLANT STAKES DURING THE DORMANT SEASON.
2. USE HEALTHY, STRAIGHT AND LIVE WOOD AT LEAST 1 YEAR OLD.
3. MAKE CLEAN CUTS AND DO NOT DAMAGE STAKES OR SPLIT ENDS DURING INSTALLATION, USE A PILOT BAR IN FIRM SOILS.
4. SOAK CUTTINGS FOR 24 HOURS (MIN.) PRIOR TO INSTALLATION.
5. TAMP THE SOIL AROUND THE STAKE.
6. THIS FIGURE IS PROVIDED FOR GUIDANCE ONLY AND DOES NOT CONSTITUTE A DESIGN. A SITE SPECIFIC DESIGN IS REQUIRED FROM DESIGNER/ENGINEER.

NOT TO SCALE

LIVE STAKING

From: Salix-Applied Earthcare - EROSION DRAW 3.0
1996 JOHN MCCULLAH



FILE: LIVESTK

Description and Purpose

- Consists of installing woody plantings (trees and shrubs) to develop a root matrix within the soil, increasing subsurface soil strength and stabilizing slopes with deeper root systems than grasses
- Reduces erosion potential of slopes

Applications

- Temporary or permanent measure
- May be used on slopes stable enough to support vegetation; however, there is a low success rate for steep slopes with gradients greater than 1H:2V
- May be used on slopes with adequate sunlight, moisture, and wind protection to support vegetation
- May be used as bio-engineering stabilization in cases of historical shallow slope instability soil movements on eroded slopes and gullies
- May be used to reduce flow velocity and in sedimentation ponds to provide higher sedimentation duration of runoff impoundment
- Particularly appropriate for highway embankments that encroach upon riparian areas or floodways
- Slopes that need additional geotechnical and erosion reinforcement are good candidates for brushlayering
- Steeper slopes require the use of inert reinforcements such as geotextiles (ECBs, TRMs, coir netting), wire (twisted or welded gabion wire) or geogrids
- If either steady, long term seepage or temporary bank return flows after flood events are a problem, the brushlayers act as a horizontal drainage layer or conduits that relieve internal pore water pressure

Advantages

- Promotes development of organic mat
- Dense leaves and large diameter plant stalks increases channel roughness and reduces flow velocities in channel thus decreasing erosion potential
- Traps sediment laden runoff and stabilizes soil
- Aesthetically pleasing once developed
- Grows stronger with time as root structure develops

- Usually has deeper root penetration than grass with greater depth of stabilization
- Manual planting may be attempted on steep slopes that are sensitive to machinery disturbance or represent an area of high erosion potential
- Of all vegetative biotechnical techniques, brushlayering has the greatest capacity for becoming successfully established, even in severe sites
- The use of synthetic geotextiles or geogrids provides long-term durability and greater security, especially if woody and herbaceous vegetation is established
- Can be used with other toe protection such as, rootwads, coir rolls, and log toes. Combining live brushlayering with rock toes is an effective and relatively low cost technique for re-vegetating and stabilizing streambanks
- Provide immediate soil stability and habitat
- Brushlayers and the pioneer vegetation that develops with them allow the establishment of a stable soil-root complex
- Both living and non-living brushlayers along streambanks enhance fish habitat, while slowing velocities along the bank during flooding flows
- They provide a flexible strengthening system to fill slopes. A bank can sag or distort without pulling apart the brushlayers
- Act as horizontal drains and favourably modify the soil water flow regime

Limitations

- Can be labour intensive to install
- Some level of uncertainty as success of plant growth is dependent on various unknown site parameters (i.e., moisture, soil, terrain, weather, seeding conditions, etc.)
- Plants may be damaged by wildlife
- Potential for low success rate
- Few precedents as this measure is generally not used on AT construction projects
- Brushlayers are vulnerable to failure before rooting occurs, and they are not effective at counteracting failure along very deep-seated failure planes

Construction

- First construct any lower bank or in-stream stabilizing measures such as a rock or log toe structure
- Excavate the first horizontal bench, sloping back into the hillslope at about 10%

- Install any drainage required along the back of each bench
- Place branches that are at least 1.8 m long on the bench
- Branches should crisscross at random with regard to size and age
- Place 20 branches per linear m on the bench, with the butts of the branches along the inside edge of the bench
- 20-45 cm of the growing tip should protrude beyond the face of the slope
- Cover and compact (add water if necessary) the brushlayer with 15 cm lifts of soil to reach the designed vertical spacing, typically 0.5 m to 1.2 m apart
- Slope the top of each fill bench back into the hill
- Construct another brushlayer
- When placed, the protruding tips of the cuttings are above the butts due to the back slope of the bench
- Proceed up the bank as desired
- The erosion and failure potential of the slope (i.e., drainage, soil type, rainfall, and length and steepness of the slope) determine spacing between the brushlayers
- On long slopes, brushlayer spacing should be closer at the bottom and spacing may increase near the top of the slope

Construction Considerations

- Successful installation requires the use of freshly cut branches or stakes
 - Storage time of cut branches/stakes on-site prior to installation should be kept to as short a time period as possible
- Successful growth dependant on soil moisture and rainfall conditions
- Consultation with agrologist, greenhouse growers, local expertise can be beneficial in selecting and procuring appropriate species for planting
- Installed during soil fill operations which result in the branches being inserted deeply into the slopes and thereby increasing the likelihood that the branches will encounter optimum soil and moisture conditions
- Live cuttings are most effective when implemented during the dormancy period of chosen plant species
- Live willow branches (or cuttings of other adventitiously-rooting species) at least 1.8 m long, with a minimum diameter of 20 mm
- Heavy equipment is usually employed for the construction of embankments

- A bucket loader and/or backhoe or excavator can facilitate the work
- Water should be available for achieving optimum soil moisture

Inspection and Maintenance

- Inspection frequency should be in accordance with the PESC and TESC Plans
- Inspect planted areas at least twice per year or after significant storm events (1:2 year storm and/or 40 mm rainfall in 24 hours)
 - Areas damaged by washout or erosion rilling should be replanted immediately
- Additional stormwater control measures should be considered for severe rilling areas damaged by runoff
- Watering plants is required for first one to two months after planting
- The live cuttings or branches should establish successfully without irrigation requirements given the proximity to water
- Inspect the cuttings for adequate vegetative establishment (as evidenced by root and shoot production from the imbedded stems) and for signs of localized erosion such as rilling from runoff or sloughing from stream scour
- Brushlayer treated streambanks should also be inspected for localized slope movements or slumps
- These localized slope failures and/or areas of poor vegetative establishment can often be repaired by re-installing the brushlayers in these zones
- The site should be examined for possible signs of flanking erosion, which must be addressed with ancillary protective measures lest the flanking threatens the integrity and effectiveness of the protective brushlayer fill
- As with all resistive streambank structures, flanking is always a potential problem
- If frozen soil is employed in constructing the soil lifts between brushlayers, some settlement may occur when the soil thaws. This settlement may falsely signal a slope failure
- The most likely causes of failure are the following:
 - Inadequate reinforcement from the brushlayer inclusions, i.e., too large a vertical spacing or lift thickness for the given soil and site conditions, slope height, slope angle, and soil shear strength properties
 - Inadequate tensile resistance in the brushlayers as result of too small an average stem diameter and/or too few stems per unit width

- Failure to properly consider seepage conditions and install adequate drainage measures, e.g., chimney drain, behind brushlayer fill, and conversely inadequate moisture applied during installation, and inadequate attention to construction procedures and details

Design Considerations

- Live branches and brushy cuttings are used to make brushlayers
- Up to 30% of the brush may be non-rooting species that provide immediate strength to the soil mass, but will then rot away
- Plant material harvesting and installation should be performed during its dormant season (late fall to early spring) or in other seasons if soil moisture is available
- The ideal plant materials for brushlayers are those that:
 - root easily
 - are long, straight and flexible
 - are in plentiful supply near the job site
- Willow makes ideal brushlayer material, and some species of *Baccharis*, *Cornus*, and *Populus* also have very good rooting ability
- All cuttings should be soaked for a minimum of 24 hours, whether they are stored or harvested and immediately installed
- Brushlayer reinforced fills must have adequate internal stability
- This means that the tensile inclusions, i.e., the brushlayers, should have a sufficient unit tensile resistance and/or be placed in sufficient numbers to resist breaking in tension
- The inclusions must also be sufficiently long and "frictional" enough to resist failure by pullout
- Allowable velocity for brushlayering is 3.7 m/s and allowable shear stress is 19 to 300 N/m² depending on how long the brushlayers have had to establish
- Schiechl & Stern (1996) suggest an allowable shear stress of 140 N/m²

Similar Measures

- Seeding
- Mulching
- Hydroseeding
- Hydromulching
- Rolled erosion control products (RECP)
- Live Staking

FRONT OF SLOPE

BACK OF TERRACE

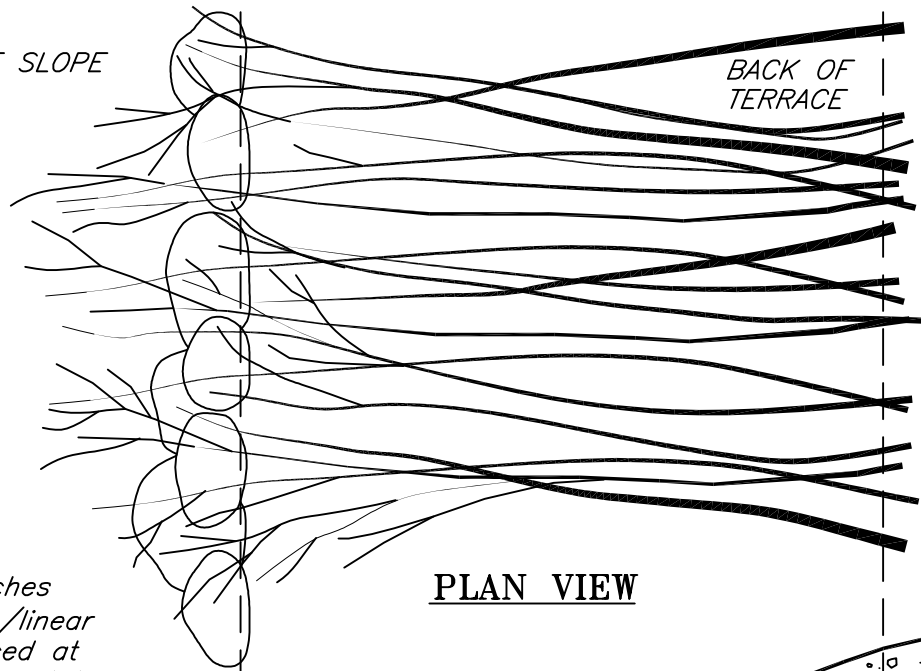

PLAN VIEW

*Crisscross branches
15-25 branches/linear
meter min. placed at
random with regard to
size and age.*

LIGHTLY COMPACTED FILL

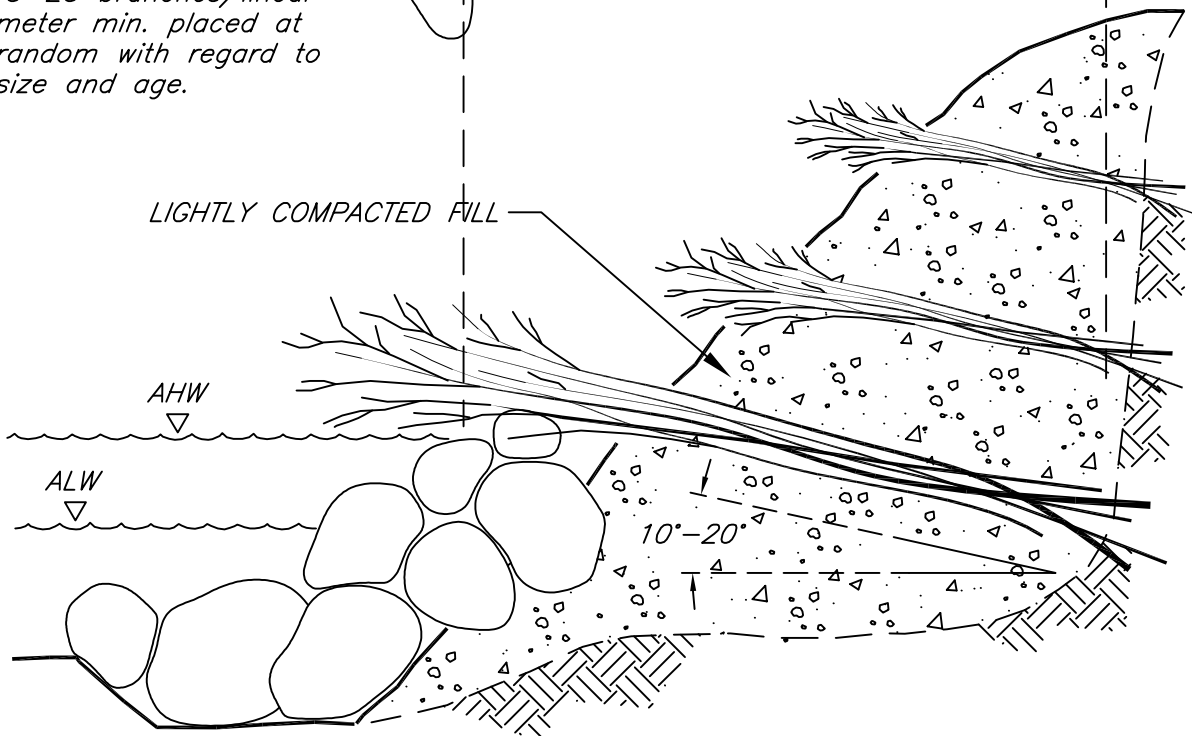

NOTES:

1. Tilt branches down into the slope 10°-20° min.
2. Brushlayering may be constructed with non-compacted or compacted backfill without damage to the brush layer.
3. Branches irrespective of length, should protrude 20-45 cm beyond the face of the slope.

**BRUSHLAYERING WITH
ROCK TOE PROTECTION**

1999 JOHN McCULLAH



FILE: BRLAY-RT

BACK OF TERRACE

FRONT OF SLOPE

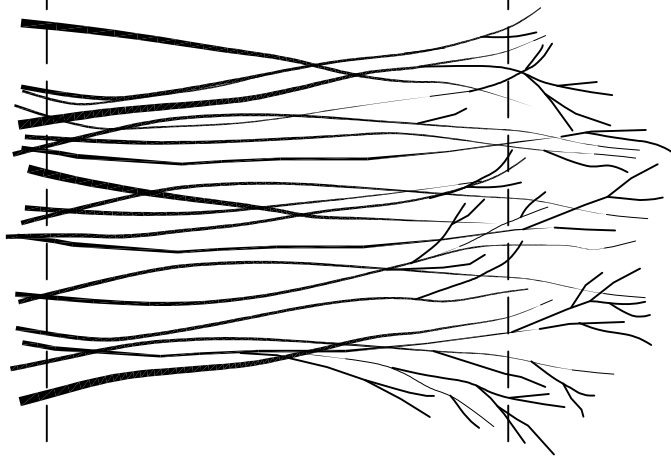

*Crisscross branches
15-25 branches/linear
meter min. placed at
random with regard to
size and age.*

PLAN VIEW

*Cover brushlayer immediately with
15 cm of fill soil, water and
compact according to specifications*

*Growing tips should protrude
from the slope face*

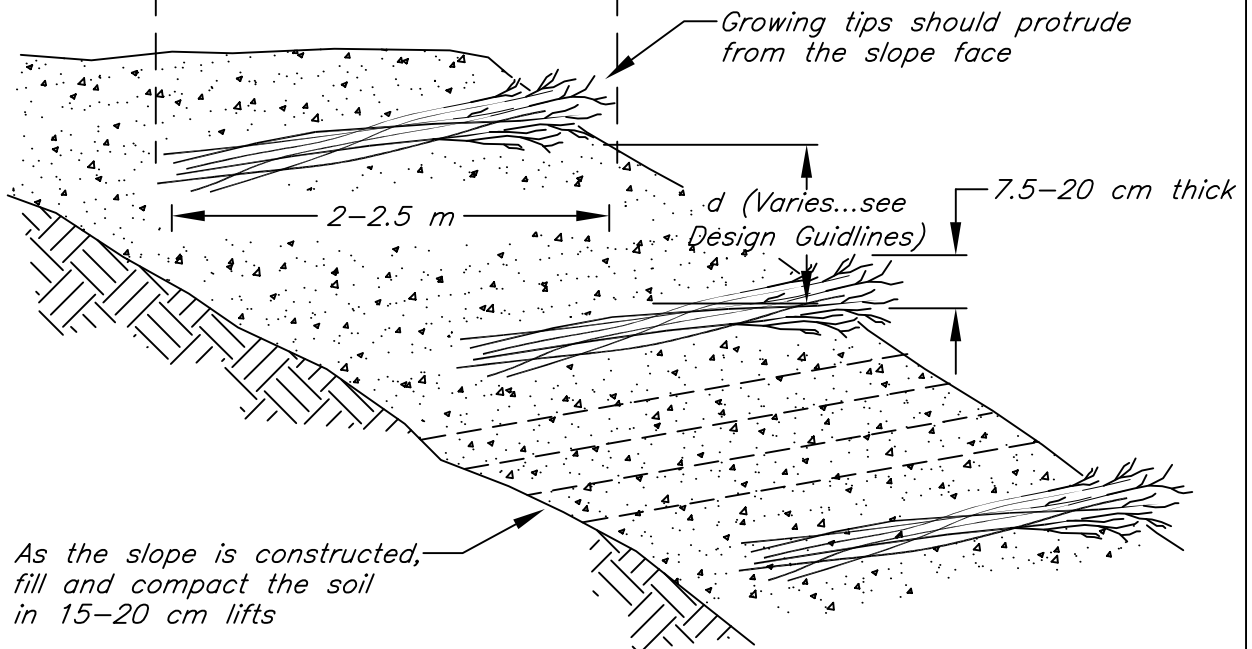

**TYPICAL BRUSHLAYERING
WITH SLOPE CONSTRUCTION**

BRUSHLAYERING

1996 JOHN McCULLAH



FILE: BRSHLAYR

NOTE:
 ROOTED, LEAFED CONDITION OF THE
 LIVING PLANT MATERIAL IS NOT
 REPRESENTATIVE OF THE TIME OF
 INSTALLATION

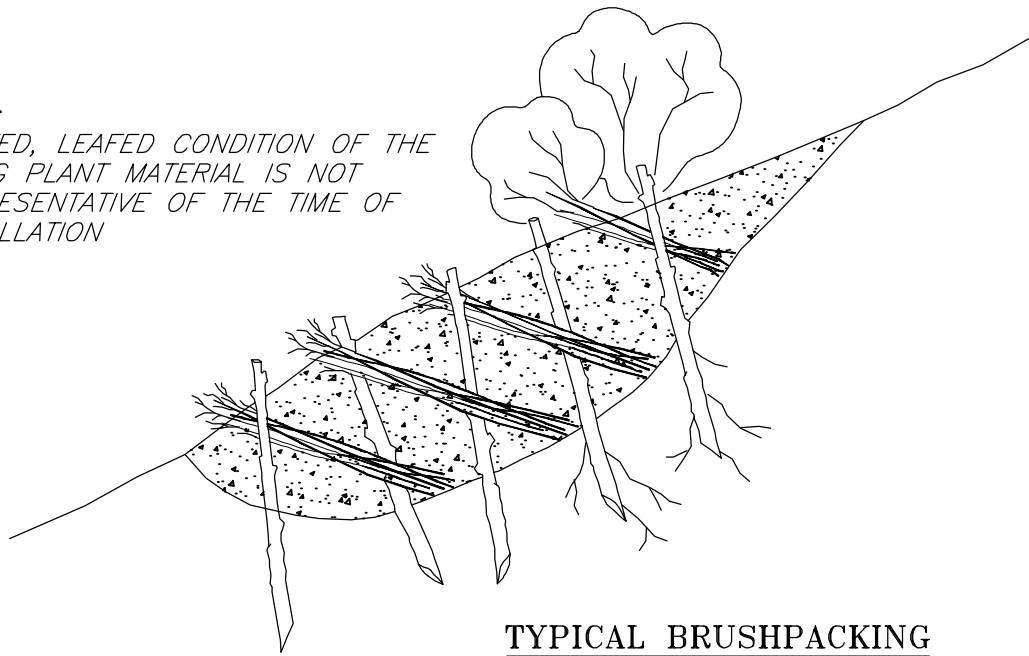

TYPICAL BRUSHPACKING

COVER BRUSHLAYER IMMEDIATELY WITH
 150 mm OF FILL SOIL, WATER AND
 COMPACT ACCORDING TO SPECIFICATIONS

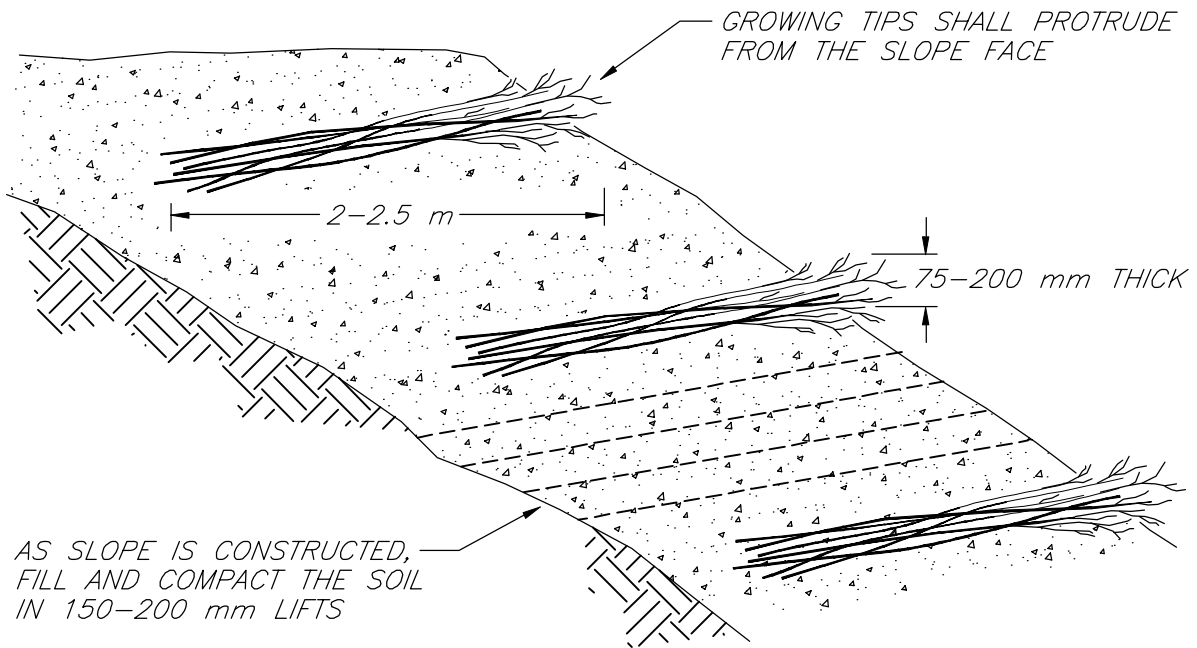

TYPICAL BRUSHLAYERING WITH SLOPE CONSTRUCTION

NOTE:
 1. THIS FIGURE IS PROVIDED FOR GUIDANCE ONLY AND DOES NOT CONSTITUTE A DESIGN. A SITE SPECIFIC DESIGN IS REQUIRED FROM DESIGNER/ENGINEER.

BRUSHLAYERING

From: Salix-Applied Earthcare - EROSION DRAW 3.0
 1996 JOHN McCULLAH



FILE: BRSHLAYR

Description and Purpose

- Wattles consist of bundled live fascine to stake into the soil along slope contours
- Normally live staking can be installed to anchor the wattles to provide deep root vegetation with potential favourable moisture retention provided by wattles
- Wattles also capture sediment, organic matter, and seeds carried by runoff

Applications

- Temporary measure
- May be used on slopes stable enough to support vegetation (steep, confined, slopes and channel banks with gradients greater than 1H:1V may have low success potential)
- May be used on slopes and channel banks with adequate sunlight, moisture, and wind protection to support vegetation
- May be used as grade breaks, where slopes transition from flatter to steep gradients
- May be used on lake shores as wave break to assist in revegetation and stabilization of banks
- Can be used in conjunction with live staking as bioengineering measure

Advantages

- Grade break measure to lower sheet and rill erosion potential
- Can be used on slopes too steep for silt fences or straw bales sediment barriers

Limitations

- Designed for low sheet flow velocities
- Designed for short slopes with a maximum gradient of 1H:1V
- May be labour intensive to install
- Few precedents as this measure is generally not used on AT construction projects
- Susceptible to undermining and failure if not properly keyed into the soil

Construction

- Prepare slope face and remove large rocks or other deleterious materials

Wattles (Live Fascine)

B.M.P. #28

Sediment Control

- Excavate small trenches a minimum of 0.15 m deep and 0.15 m wide across the width of the slope, perpendicular to slope direction, starting at the toe of the slope and working upwards towards crest of slope
- Space trenches a maximum of 3 to 8 m apart along the slope incline, with steeper slopes having trenches spaced closer together
- Place wattles into trench ensuring continuous contact between wattles and soil surface
- Butt-joint adjacent wattle segments tightly against one another
- Use a metal bar to make pilot hole through middle of the wattle a minimum depth of 0.3 m into underlying soil
- Pilot holes should be spaced a maximum of 1 m apart
- Secure wattle to soil using wooden stake or other appropriate anchor; live stake may be used as alternate anchor
- Place soil excavated from trench on upslope side of wattle and compact to minimize undermining of wattle by runoff
- Seed the soil along the upslope and downslope sides of the wattle to promote vegetation growth

Construction Considerations

- Use live stakes in place of wooden stakes
- If the slope soil is loose and uncompacted, excavate trench to a minimum depth of 2/3 of the diameter of the wattle
- For steep slopes, additional anchors placed on the downslope side of the wattle may be required

Inspection and Maintenance

- Inspection frequency should be in accordance with the PESC and TESC Plans
- Areas damaged by washout or rutting should be repaired immediately
- Additional stormwater control measures should be considered for rilling areas damaged by runoff

Similar Measures

- Synthetic permeable barriers

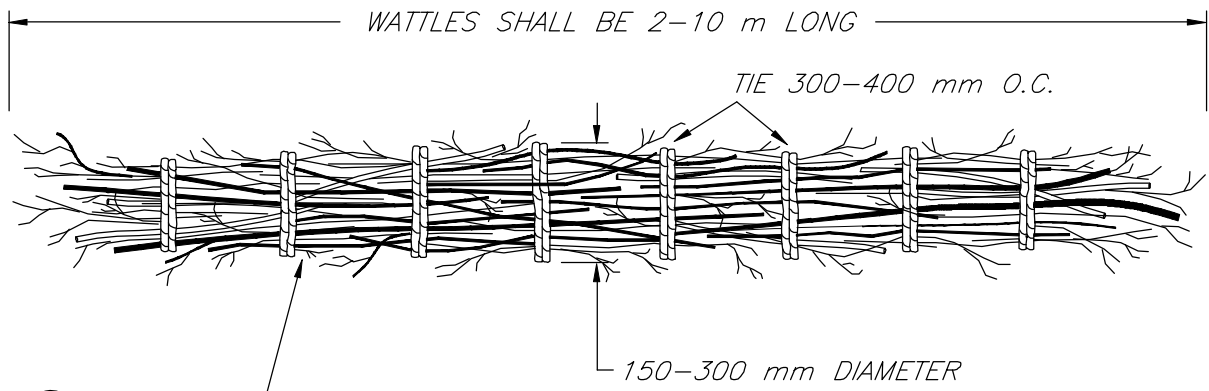

PREPARE WATTLES WITH 6-40 mm CUTTINGS, WITH ALTERNATING BUTT-ENDS AND TIED SECURELY WITH TWINE OR ROPE.

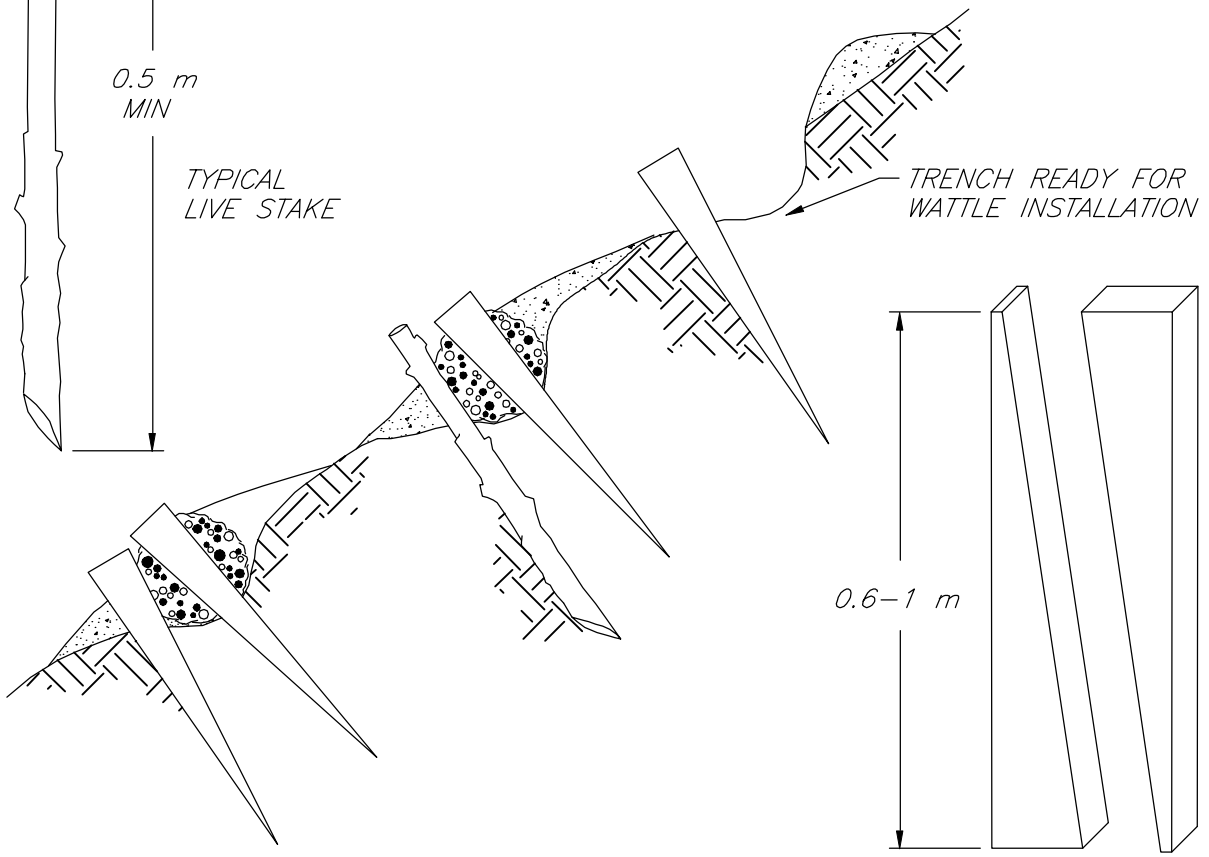
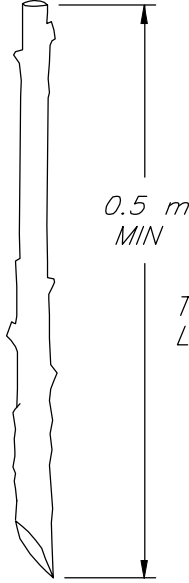

NOTES:

1. HARVEST AND INSTALL WATTLES DURING DORMANT SEASON.
2. INSTALL WATTLES ON SLOPE CONTOURS.
3. ALL WORK PROCEEDS FROM THE BOTTOM OF THE SLOPE TO THE TOP.
4. FILL OR PARTIALLY COVER WATTLE WITH SOIL FROM SLOPE OR TRENCH ABOVE.
5. COMPACT AND WORK SOIL INTO COMPLETED WATTLES.
6. THIS FIGURE IS PROVIDED FOR GUIDANCE ONLY AND DOES NOT CONSTITUTE A DESIGN. A SITE SPECIFIC DESIGN IS REQUIRED FROM DESIGNER/ENGINEER.

TYPICAL CONSTRUCTION STAKE
SAW 2X4 (100X50 mm) LUMBER
ON DIAGONAL

NOT TO SCALE

**WATTLE
(LIVE FASCINE)**

From: Salix-Applied Earthcare - EROSION DRAW 3.0
1996 JOHN McCULLAH



FILE: WATTLE

| | |
|-------------------------------------|------------|
| Chemical Stabilization (Tackifiers) | B.M.P. #29 |
|-------------------------------------|------------|

Removed

Description and Purpose

- Protection of existing plants and trees adjacent to all natural water bodies (riparian zones) adjacent to construction areas
- Existing vegetation acts as an effective vegetative buffer strip as a form of erosion and sediment control measure

Applications

- Permanent measure
- Existing established vegetation acts as an effective sediment control and erosion control buffer strip barrier to slow down flows and allow sedimentation filtration to occur
- May be used along property boundaries to minimize sediment transport off construction site despite non-presence of watercourse adjacent

Advantages

- Existing dense vegetation is more effective than any man-made structures or devices for sediment or erosion control, however, other forms of sediment and erosion control measures may be required on construction sites in addition to preserved riparian zones
- Any denuding of vegetation along steep valley slope with highly erodible soil will be detrimental and inducive to long-term sedimentation yield; it is important only to strip necessary areas along the footprint of construction. Preservation of riparian zone is mandatory along river valley slopes and along the edge corridor of waterbodies

Limitations

- Preservation of riparian zones may interfere with construction efficiency
- Careful planning is required to work around preserved riparian zones

Construction

- It is highly important to preserve an established vegetative buffer as freshly planted vegetation generally require substantial growth periods before they are as effective as established riparian zones
- Wherever possible, retain as much existing vegetation as possible between construction areas and sensitive zones (wetlands, marshes, streams, floodplains, etc.) to entrap sediment and to minimize sediment transport off of the construction site into the sensitive zones

| | |
|--------------------------------------|------------|
| Riparian Zone Preservation | B.M.P. #30 |
| Sediment Control and Erosion Control | |

- Define and delineate riparian zones to be preserved in Environmental Construction Operations Plan (ECO Plan) prior to commencement of construction
- Clearly mark riparian zones to be preserved in the field (with construction fencing, survey flagging, or other highly visible measure) so all personnel involved with construction operations can identify areas to be preserved

Construction Considerations

- Riparian zones must be fenced off immediately to minimize trespassing and to ensure effectiveness of riparian zone is maintained
- Do not allow equipment to enter areas not necessary to construction
- Based on site-specific situations established buffer zones of adequate width

Inspection and Maintenance

- Inspection frequency should be in accordance with the PESC and TESC Plans
- Maintain fences protecting riparian zones from trespassing

| | |
|--|-------------------|
| Pumped Silt Control Systems (Filter Fabric Bags) Sediment Control and Erosion Control | B.M.P. #31 |
|--|-------------------|

Description and Purpose

- The extraction of sediment is effected by pumping sediment laden runoff into a bag manufactured with a permeable geotextile. Water will filter through the filter bag with the sediment being retained within the filter bag

Applications

- Temporary measure
- Can be used in high risk areas to supplement performance of containment pond systems
 - An example area would be where containment pond space is limited on construction site and appropriate sized containment pond cannot be constructed adjacent to high risk areas
- Useful for additional extraction of sediment dewatering sumps, sediment ponds, or other retention facilities with accumulations of sediment laden runoff

Advantages

- Filter bag is lightweight and portable
- Simple cleanup and disposal
- Sediment is captured within filter bag for removal from site

Limitations

- May be expensive
 - Extra costs associated with cost of filter bags and costs of pumping out retention facilities
- Power supply for pumps may be required
- Useful for only short periods of time and small volumes of water
- Can only retain particle sizes larger than the Apparent Opening Size (AOS) of the filter fabric bag
- Refer to manufacturers' product performance information
- Generally for available non-woven filtration geotextile, AOS values of 0.15 mm range or lower can be realistically manufactured. Potentially, only particle size larger than the design AOS value can be removed from the bag types. It is important to require manufacturer to provide performance specification and physical properties of the bags. The designer and supplier of the filter bag should choose

| | |
|--|-------------------|
| Pumped Silt Control Systems (Filter Fabric Bags) Sediment Control and Erosion Control | B.M.P. #31 |
|--|-------------------|

the fabric and AOS based on the anticipated gradation of the sediments to ensure the sediments are retained in the bag.

- Few precedents as this measure is generally not used on AT construction projects, however, it can be resorted as emergency measure for highly sensitive sites

Implementation

- Place filter bag on free-draining base (such as gravel pad or straw pile) on a slight slope, with opening to silt bag facing upslope
- Attach hose to opening of filter bag
 - Ensure tight seal to prevent discharge of sediment laden runoff outside of bag
- Attach hose to pump and insert extraction hose into retention facility to be dewatered
- Turn on pump and remove sediment laden water until filter bag is full of sediment
- Disengage pump once filter bag is full, tightly close opening to filter bag to prevent spilling of sediment and remove bag
- Repeat process (using new filter bags) until retention facility is dewatered to acceptable levels

Implementation Considerations

- Full filter bags can be removed from site or buried in designated locations on-site
- Care should be taken to ensure filter bag is not overfilled, which may cause filter bag to tear, spilling sediment
- Care should be taken when transporting full filter bags to ensure filter bag is not torn

Inspection and Maintenance

- Inspect all hoses and connections before and during pumping operations to minimize leaks

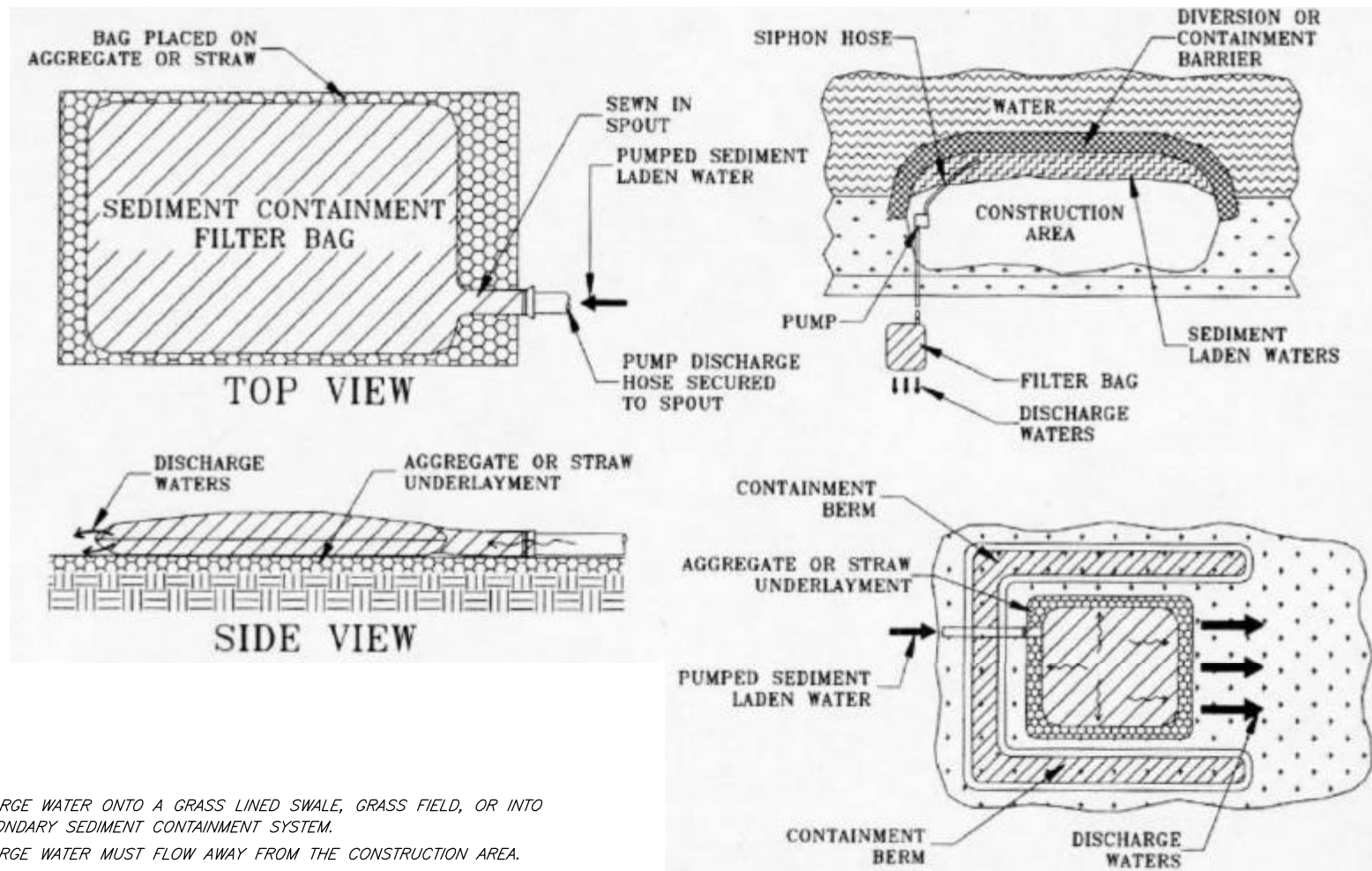

NOTES:

1. DISCHARGE WATER ONTO A GRASS LINED SWALE, GRASS FIELD, OR INTO A SECONDARY SEDIMENT CONTAINMENT SYSTEM.
2. DISCHARGE WATER MUST FLOW AWAY FROM THE CONSTRUCTION AREA.
3. SEDIMENT CAPTURED BY THE FILTER BAG MUST BE REMOVED AND STABILIZED.
4. THIS FIGURE IS PROVIDED FOR GUIDANCE ONLY AND DOES NOT CONSTITUTE A DESIGN. A SITE SPECIFIC DESIGN IS REQUIRED FROM DESIGNER/ENGINEER.

SOURCE: FIFIELD 2001

PUMPED SILT CONTROL SYSTEM

Description and Purpose

- Scheduling the sequence and timing arrangement of construction activities (1) to efficiently maximize the amount of erosion protection installed (such as topsoiling and seeding) as soon as a portion of grade construction is completed, and (2) to limit the portion of land disturbance (construction) compatible with the efficient rate of construction of erosion control measures achievable
- Incorporating erosion and sedimentation control concerns during the scheduling phase will minimize the amount and duration of bare soil exposure to erosion elements and ensure erosion and sedimentation control measures are implemented at an appropriate time
- Scheduling may be designed during planning stages by the contractor and altered during construction to suit actual conditions encountered

Applications

- Temporary measure

Advantages

- Ensures erosion and sedimentation control issues are identified during the planning stage by the Contractor
- May be used to minimize bare soil exposure and erosion hazard with careful planning and utilization of equipment in construction projects

Limitations

- May be more costly as erosion control measures (such as topsoiling and seeding) have to be implemented immediately after completion of each phase or a short section of construction

Implementation

- Incorporate a schedule with erosion protection perspective to form part of the overall construction plan
- Determine sequencing and timetable for the start and end of each item, such as clearing, grubbing, stripping, etc.
- Incorporate installation of appropriate erosion and/or sediment control measures in construction schedule
- Allow sufficient time before rainfall begins to install erosion and/or sediment control measures

| | |
|--------------------------------------|------------|
| Scheduling | B.M.P. #32 |
| Sediment Control and Erosion Control | |

- Whenever possible, schedule work to minimize extent of site disturbance at any one time
- Incorporate staged topsoiling and revegetation of graded slopes as work progresses
 - Don't leave all topsoiling and revegetation until the very end of the project

Inspection and Maintenance

- Routinely verify that construction activities and the installation of erosion and sediment control measures is progressing in accordance with schedule
 - If progress deviates from schedule, take corrective action
- When changes to the project schedule are unavoidable, alter the schedule as soon as practicable to maintain control of erosion

Description and Purpose

- Comprised of a gravel pad located at site access points (entrances) that are used to reduce the amount of sediment carried off construction sites by vehicles
- Collect sediment from vehicle washing and retains sediment on construction site
- Should include water supply to wash off excess soil from vehicles prior to exiting the construction site

Applications

- Temporary measure
- For use anywhere vehicles enter or exit a construction site

Advantages

- Retains sediment on construction site, where it belongs
- Reduces deposition of sediments on public roads which may be carried by runoff into natural watercourses or drains

Limitations

- Sediment control measures should be installed to collect sediment laden runoff from gravel pad
- Installation of gravel pads may be limited by space constraints

Implementation

- Install gravel pad at planned entrances to worksite
 - Gravel pad (minimum of 15 m in length) should be of sufficient length to accommodate longest anticipated vehicle entering or exiting the site
 - Width of pad should be sufficient to accommodate the widest anticipated vehicle entering or exiting the site (minimum of 3.6 m in width)
 - Thickness of gravel pad should be a minimum of 0.30 m thick (0.3 m thickness is preferred for highway projects) and should comprise 50 to 150 mm diameter coarse aggregate placed on top of woven geotextile filter fabric
- Install temporary sediment control measures (such as straw bale barriers or silt fences) to collect washed off sediment from gravel pad

| | |
|---|-------------------|
| Stabilized Worksite Entrances | B.M.P. #33 |
| Sediment Control and Erosion Control | |

Construction Considerations

- Should be constructed at all access points to construction sites
 - If impractical to construct at all access points, limit vehicle access traffic to stabilized worksite entrances only
- Entrances located with steep grades or at curves on public roads should be avoided
- Woven geotextile filter fabric should be used as underlay below gravel pad as strength requirement
- Install an elevated ridge adjacent to roadway if gradient of the gravel pad is steeper than 2%, sloped towards the roadway

Inspection and Maintenance

- Inspection frequency should be in accordance with the PESC and TESC Plans
- Granular material should be regraded when required
 - Material may need to be added to fill large voids to maintain a minimum pad thickness of 0.30 m
- Inspect and clean out downstream sediment control measures at least once per week and after periods of significant rainfall
- Material accidentally deposited onto public roads should be cleaned as soon as possible

DIVERSION RIDGE REQUIRED
WHERE GRADE EXCEEDS 2%

2 % OR GREATER

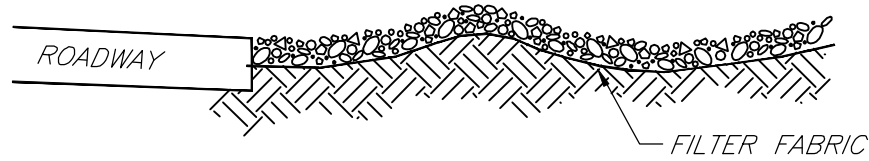

SECTION A - A

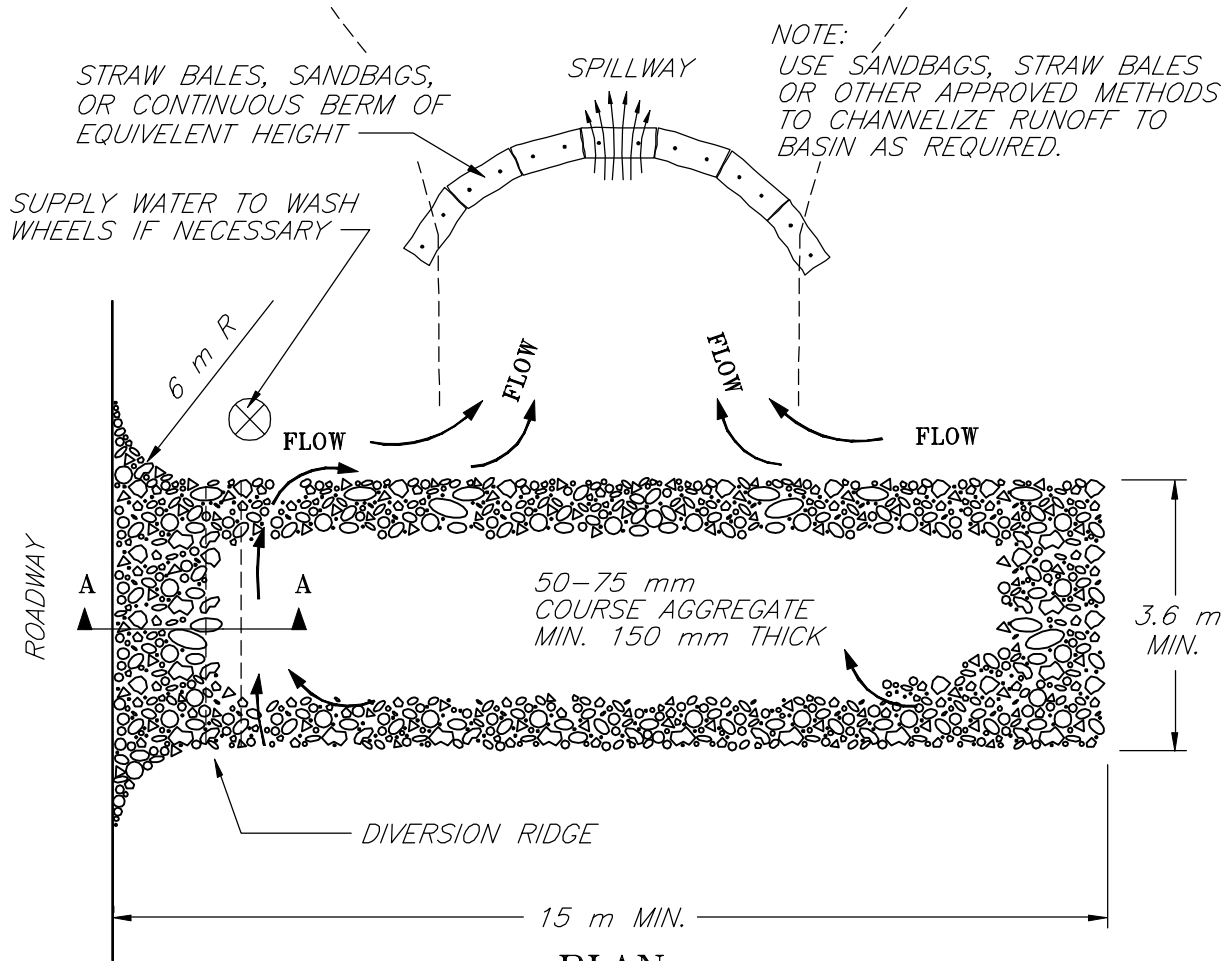

PLAN

NOTES:

1. THE ENTRANCE SHALL BE MAINTAINED IN A CONDITION THAT WILL PREVENT TRACKING OR FLOWING OF SEDIMENT ONTO PUBLIC RIGHT-OF-WAYS. THIS MAY REQUIRE TOP DRESSING, REPAIR AND/OR CLEANOUT OF ANY MEASURES USED TO TRAP SEDIMENT.
2. WHEN NECESSARY, WHEELS SHALL BE CLEANED PRIOR TO ENTRANCE ONTO PUBLIC RIGHT-OF-WAY.
3. WHEN WASHING IS REQUIRED, IT SHALL BE DONE ON AN AREA STABILIZED WITH CRUSHED STONE THAT DRAINS INTO AN APPROVED SEDIMENT TRAP OR SEDIMENT BASIN.
4. FOR HIGHWAY CONSTRUCTION, 300mm THICKNESS OF GRAVEL IS PREFERRED.
5. THIS FIGURE IS PROVIDED FOR GUIDANCE ONLY AND DOES NOT CONSTITUTE A DESIGN. A SITE SPECIFIC DESIGN IS REQUIRED FROM DESIGNER/ENGINEER.

**TEMPORARY
GRAVEL
CONSTRUCTION
ENTRANCE/EXIT**

From: Salix-Applied Earthcare - EROSION DRAW 3.0
1994 JOHN McCULLAH



FILE: ENTRANCE

Description and Purpose

- Texturing of slopes, either by roughening the surface, tracking the surface, or installing grooves or benches
 - Texturing reduces the runoff velocity, traps sediment, and increases the infiltration of water into the soil
- a) Surfacing Roughening
 - b) Grooved or Serrated Slope
 - c) Benched Slope

Applications

- Temporary measure
- May be used to roughen the exposed soils on the slope surface in the direction of water flow to minimize erosion and to entrap some sediments
- May be used on fresh cut or fill slopes (8 m length or longer; practical travel reach of a dozer) with gradients of generally 3H:1V or steeper (2H:1V as general steepness limit) constructed in cohesive soils
- May be used on slope subgrade that will not be immediately topsoiled, vegetated or otherwise stabilized
- May be applied to topsoiled slope to provide track serration to further reduce erosion potential
- May be used in graded areas with smooth and hard surfaces
- As part of slope design, benching may be used to effect a reduction of erosion hazard where a long slope length needs to be shortened into smaller sectional lengths with mid-benches; normally a 3 m wide bench can be appropriate
 - Benching is usually a permanent slope design feature and should only be designed by a qualified geotechnical engineer
 - Benching of a long slope section to divide into short sections can reduce erosion hazard in the range of 30 to 50% (e.g., sediment yield for 15 m high 3H:1V slope with mid-bench)

Advantages

- Reduces erosion potential of a slope
- Texturing will create protrusions to increase surface roughness to reduce overland flow velocities and erosion energy
- Texturing will create minor spaces to entrap a portion of the coarse sediment and reduces amount of sediment transported downslope
- Texturing of slopes will benefit development of vegetation
- Texturing of slopes aids in performance of mulches and hydroseeding
- Texturing with track-walking up/downstream may effect a 50% reduction of sediment yield compared with untracked slope

Limitations

- Surface roughening and tracking may increase grading costs
- Surface roughening and tracking may cause sloughing in certain soil types (i.e., sandy silt) and seepage areas; geotechnical advice is recommended
- Texturing provides limited sediment and erosion control and should be used as a temporary measure prior to topsoiling
 - Should be used in conjunction with other erosion and sediment control measures (i.e., offtake ditches) to limit the sheet flow downslope

Construction

- Surface Roughening
 - Leave soil in rough grade condition, do not smooth grade soil
 - Large lumps of soil will aid in decreasing runoff velocities, trap sediment, and increase infiltration of water
- Surface Tracking
 - Using tracked construction equipment to move up and down the slope, leaving depressions perpendicular to the slope direction; limit passes to prevent overcompaction of the surface
 - Depressions in the soil will aid in decreasing runoff velocities, trap sediment, and increase infiltration of water
- Grooving
 - Excavating shallow furrows across the width of the slope, perpendicular to the direction of the slope

| | |
|-----------------------|-----------------------|
| Slope Texturing (a-c) | B.M.P. #34 (a - c) |
| Sediment Control | |

- If used, contour grooves should be approximately 0.1 to 0.2 m in depth
- Grooves can be made by using equipment or hand
- Benching
 - Construction of narrow, flatter sections of soil on the slope, perpendicular to the direction of the slope
 - Benches should be designed by qualified geotechnical engineer

Construction Considerations

- During tracking operations, care must be taken to minimize disturbance to the soil where the equipment turns or changes direction
- Minimize the number of tracking passes to 1 or 2 times to avoid overcompaction, which can negatively impact the vegetation growth
- It is practical to track roughen a slope length of greater than 8 m for practical up/down slope operation of a small bulldozer. It is important to minimize the loosening of soil caused by turning movement of the bulldozer at the end of each pass. As the erosion potential is lower for slope of low vertical height (<3 m height and 3H:1V slope), the tracking of low height slope is not required and not practical for bulldozer tracking operation.

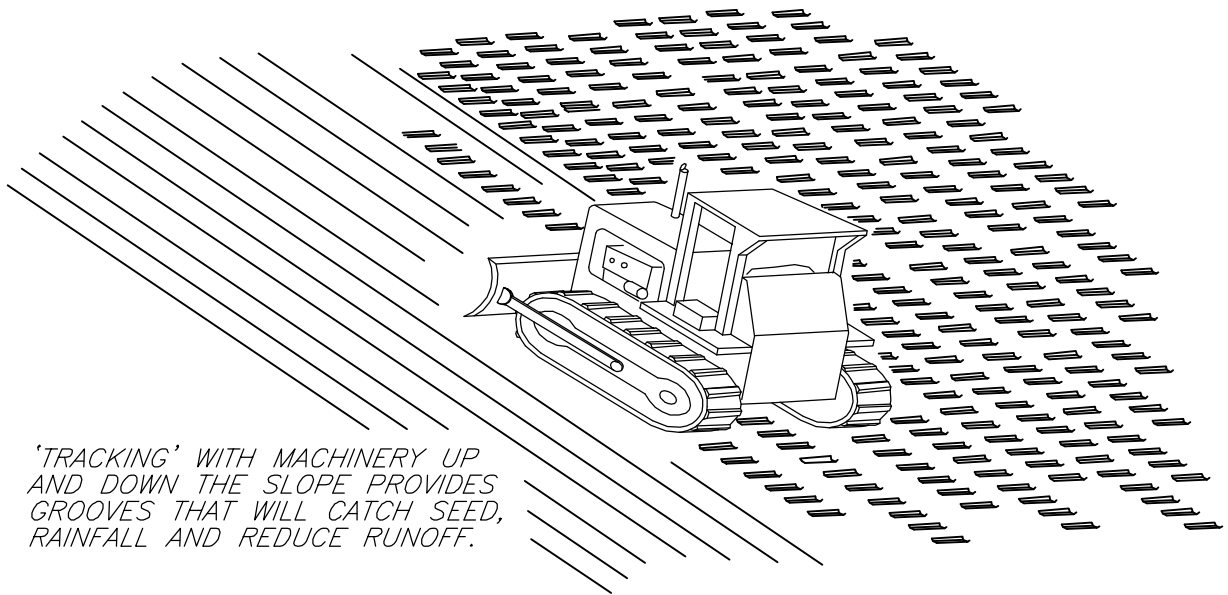

'TRACKING' WITH MACHINERY UP AND DOWN THE SLOPE PROVIDES GROOVES THAT WILL CATCH SEED, RAINFALL AND REDUCE RUNOFF.

TRACKING

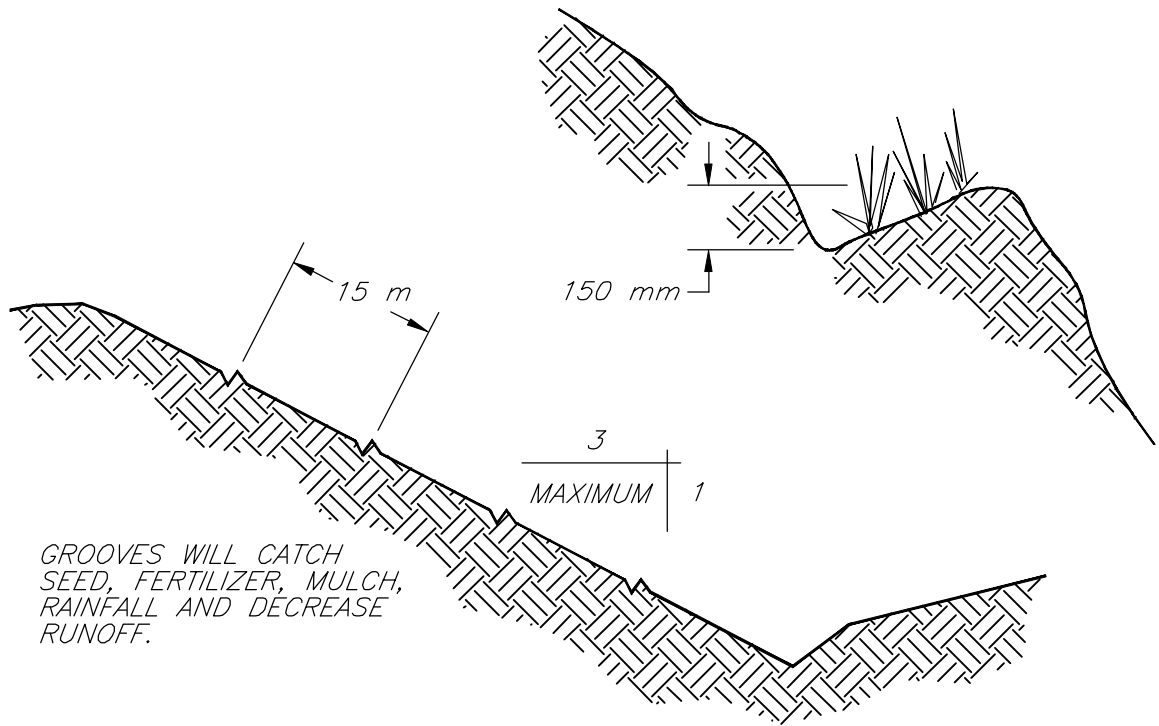

GROOVES WILL CATCH SEED, FERTILIZER, MULCH, RAINFALL AND DECREASE RUNOFF.

CONTOUR FURROWS

**SURFACE
ROUGHENING**

From: Salix-Applied Earthcare - EROSION DRAW 3.0
1994 JOHN McCULLAH



FILE: SRFROUGH

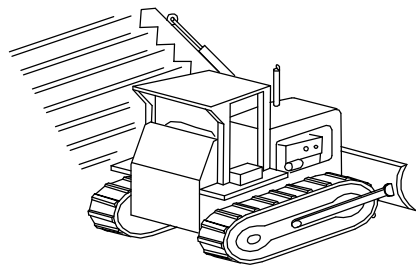
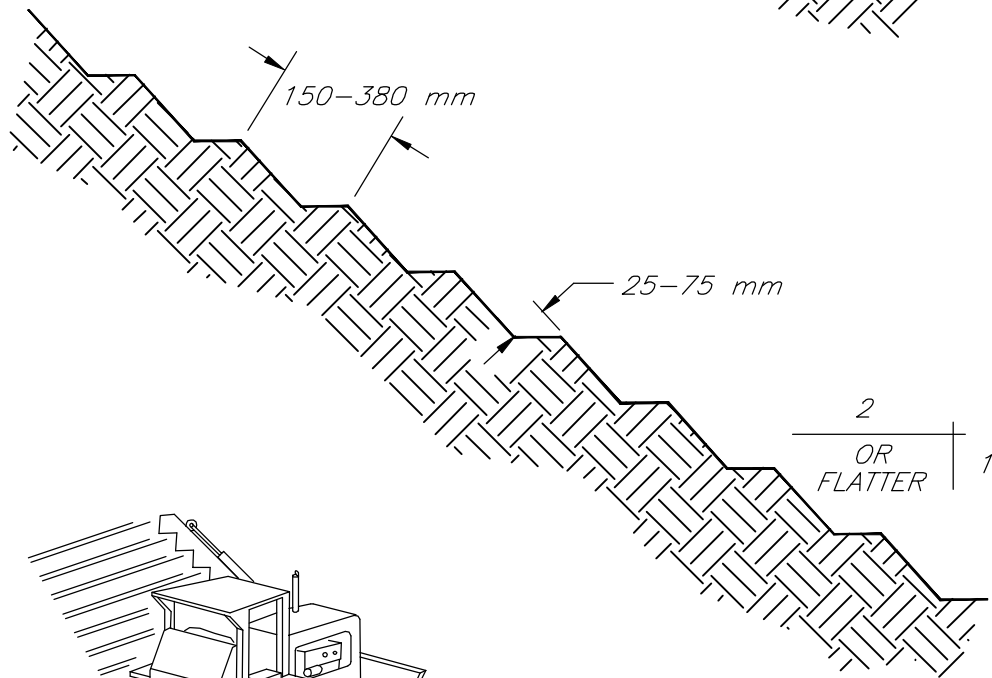
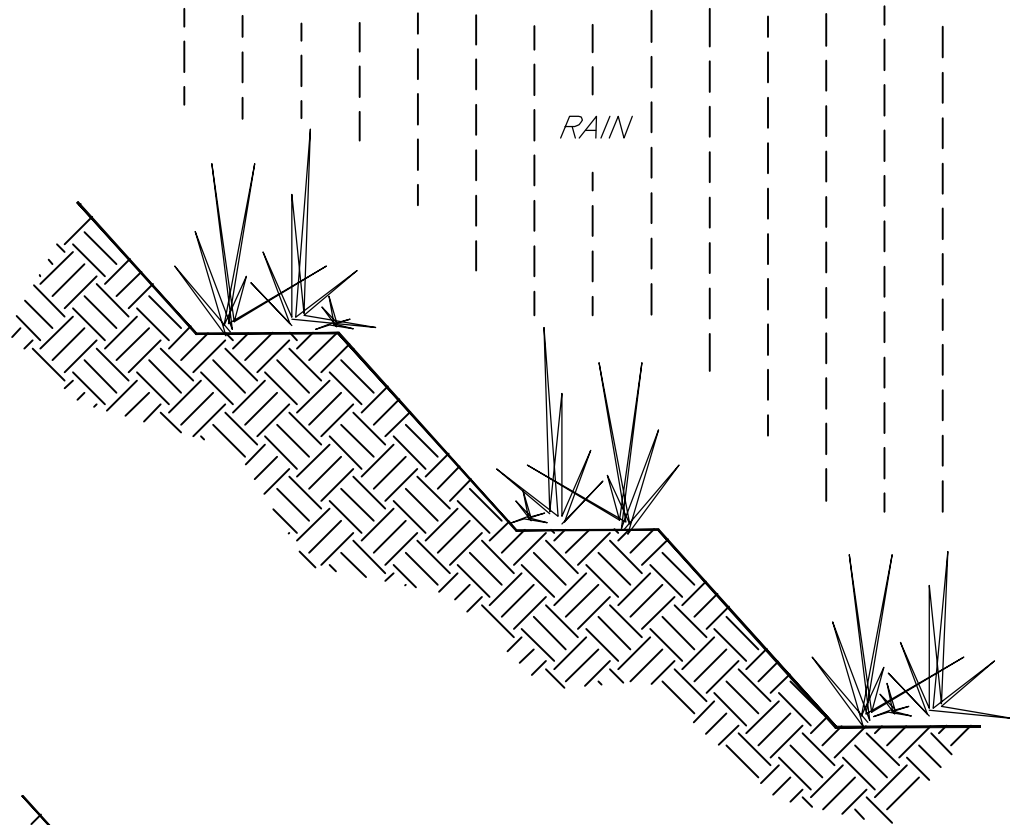

NOT TO SCALE

NOTE:

GROOVE BY CUTTING SERRATIONS ALONG THE CONTOUR. IRREGULARITIES IN THE SOIL SURFACE CATCH RAINWATER, SEED, MULCH AND FERTILIZER.

**GROOVED OR
SERRATED SLOPE**

From: Salix-Applied Earthcare – EROSION DRAW 3.0
1994 JOHN McCULLAH



FILE: SERSLOPE

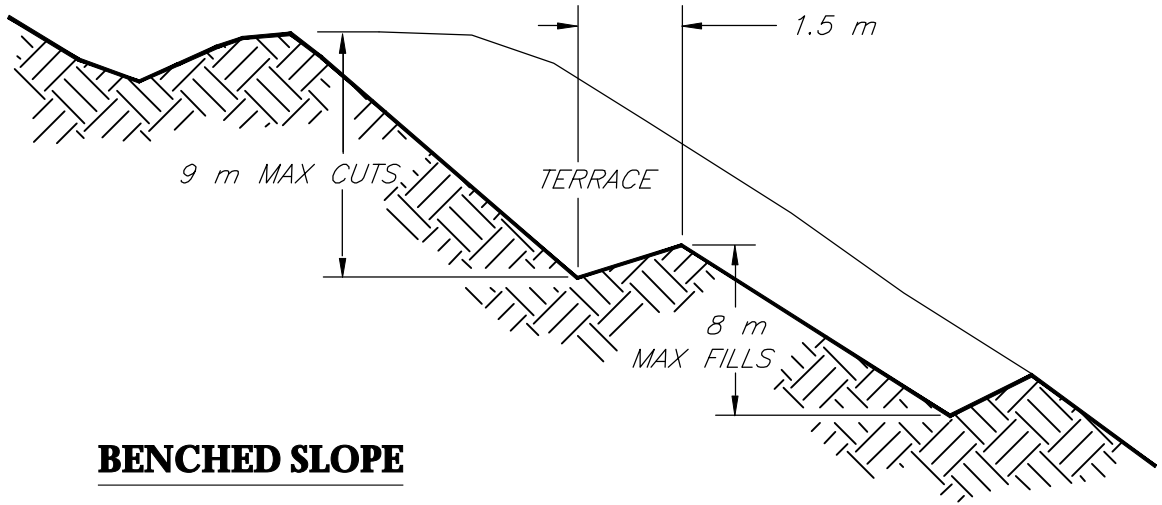

BENCHED SLOPE

NOT TO SCALE

BENCHED SLOPE

From: Salix—Applied Earthcare — EROSION DRAW 3.0
1994 JOHN McCULLAH



FILE: STPSLOPE

Straw Mulching & Crimping

(Straw Anchoring)

Sediment Control and Erosion Control

B.M.P. #35

Description and Purpose

- Straw mulch consists of placing a uniform layer of straw and incorporating it into the soil with a studded roller or anchoring it with stabilizing emulsion
- Protects the soil surface from the impact of rain drops, preventing soil particles from being dislodged

Applications

- Temporary measure
- Used for soil stabilization as a temporary surface cover on disturbed areas until soils can be prepared for revegetation and permanent vegetation is established
- Also used in combination with temporary and/or permanent seeding strategies to enhance plant establishment

Advantages

- Relatively cheap method of promoting plant growth and slope protection

Limitations

- Availability of erosion control contractors and straw may be limited prior to the rainy season due to high demand
- There is a potential for introduction of weed-seed and unwanted plant material
- When straw blowers are used to apply straw mulch, the treatment areas must be within 45 m of a road or surface capable of supporting trucks
- Straw mulch applied by hand is more time intensive and potentially costly
- Wind may limit application of straw and blow straw into undesirable locations
- May have to be removed prior to permanent seeding or soil stabilization
- “Punching” of straw does not work in sandy soils
- Crimping will tend to leave an uneven surface
- Netting can become displaced and entangled in mowing equipment

Straw Mulching & Crimping

(Straw Anchoring)

Sediment Control and Erosion Control

B.M.P. #35

Installation

- Apply loose straw at a minimum rate of 3,570 kg/ha, or as indicated in the projects special provisions, either by machine or by hand distribution
- If stabilization emulsion will be used to anchor the straw mulch in lieu of incorporation, roughen embankment or fill areas by rolling with a crimping or punching-type roller or by track walking before placing the straw mulch
- Track walking should only be used where rolling is impractical
- The straw mulch must be evenly distributed on the soil surface
- Anchor the mulch in place by using a tackifier or by “punching” it into the soil mechanically (incorporating)
- A tackifier acts to glue the straw fibres together and to the soil surface
- The tackifier shall be selected based on longevity and ability to hold the fibres in place
- A tackifier is typically applied at a rate of 140 kg/ha
- In windy conditions, the rates are typically 2000 kg/ha
- Methods for holding the straw mulch in place depend upon the slope steepness, accessibility, soil conditions and longevity
- On small areas, a spade or shovel can be used to incorporate straw mulch
- On slopes with soils, which are stable enough and of sufficient gradient to safely support construction equipment without contributing to compaction and instability problems, straw can be “punched” into the ground using a knife-blade roller or a straight bladed coulter, known commercially as a “crimper”
- The mulch crimping device consists of a series of dull flat discs with notched edges spaced approximately 20 cm apart
- The mulch should be impressed in the soil to a depth of 3 to 8 cm
- Mechanical anchoring, or crimping, is recommended only for slopes flatter than 2:1
- Mulch on slopes steeper than 2:1 should be anchored to the soil with netting
- On small areas and/or steep slopes, straw can also be held in place using a plastic or jute netting
- The netting shall be held in place using wire staples, geotextile pins or wooden stakes

Straw Mulching & Crimping

(Straw Anchoring)

Sediment Control and Erosion Control

B.M.P. #35

Construction Considerations

- Straw shall be derived from clean long stemmed grass hay or cereal shaft (e.g., wheat or barley), free from undesirable weed and seed
- A minimum of 65% of the mulch, by weight, should be 25 cm or more in length
- Expected longevity: < 3 months
- A tackifier is the preferred method for anchoring straw mulch to the soil on slopes
- Crimping, punch roller-type rollers, or track-walking may also be used to incorporate straw mulch into the soil on slopes
- Track walking shall only be used where other methods are impractical
- Avoid placing straw onto the traveled way, sidewalks, line drainage channels, sound walls, and existing vegetation
- Straw mulch with tackifier shall not be applied during or immediately before rainfall

Inspection and Maintenance

- Inspection frequency should be in accordance with the PESC and TESC Plans
- The straw needs to last long enough to achieve erosion control objectives
- Areas where erosion is evident should be repaired and BMPs re-applied as soon as possible
- Care should be exercised to minimize damage to protected areas
- Repair any damaged ground cover and re-mulch exposed areas
- Re-application of straw mulch and tackifier may be required to maintain effective soil stabilization over disturbed areas and slopes
- Maintain all slopes to prevent erosion after any rainfall event

Similar Measures

- Mulching

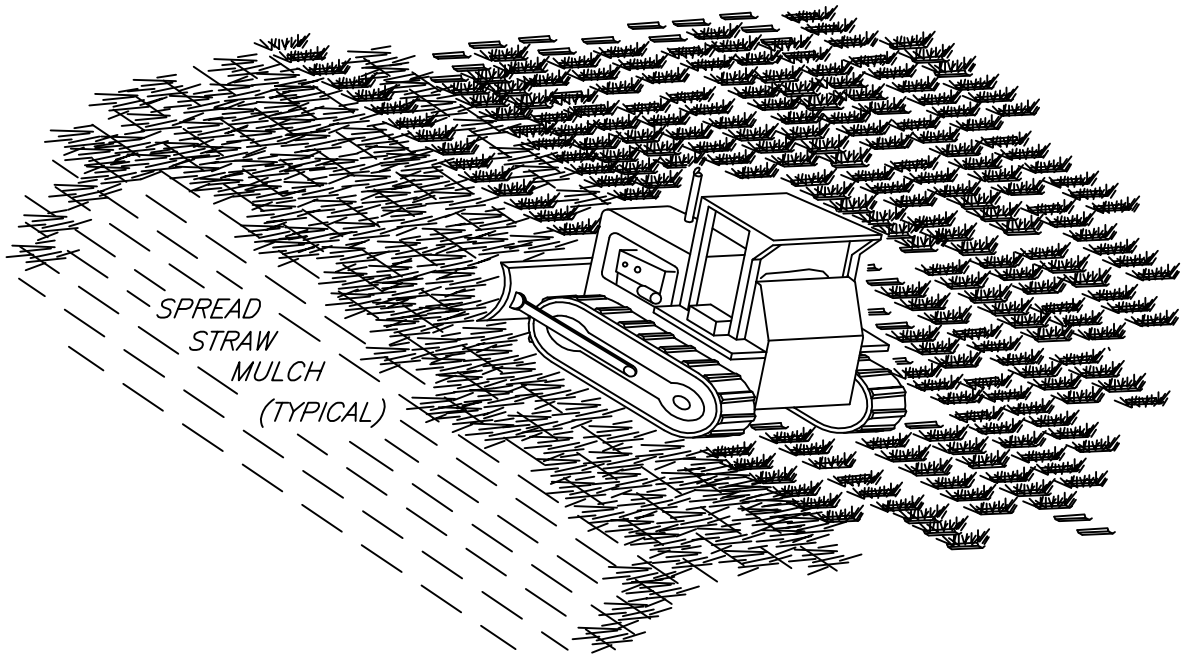

'TRACKING' WITH MACHINERY ON SANDY SOIL PROVIDES ROUGHENING WITHOUT UNDUE COMPACTION.

STRAW MULCHING & CRIMPING

NOTES:

- 1. ROUGHEN SLOPE WITH BULLDOZER*
- 2. BROADCAST SEED AND FERTILIZER.*
- 3. SPREAD STRAW MULCH 76mm THICK. (2 1/2 TONS PER ACRE)*
- 4. PUNCH STRAW MULCH INTO SLOPE BY RUNNING BULLDOZER UP AND DOWN SLOPE.*

STRAW MULCHING & CRIMPING

Description and Purpose

- The land application of product containing anionic polyacrylamide (PAM) as temporary soil binding agents to reduce soil erosion
- To reduce erosion from wind and water on construction sites and agricultural lands

Applications

- This temporary practice is intended for direct soil surface application to sites where the timely establishment of vegetation may not be feasible or where vegetative cover is absent or inadequate
- Such areas may include construction sites where land-disturbing activities prevent the establishment or maintenance of a vegetative cover

Advantages

- Enhances terrestrial and aquatic habitat with vegetation growth re-establishment
- Aesthetically pleasing with vegetation cover
- Improved water quality, infiltration, soil fertility and visibility

Limitations

- This temporary practice is not intended for application to surface waters
- It is intended for application within construction storm water ditches and storm drainages which feed into pre-constructed sediment ponds or basins

Installation

- **Only the anionic form of PAM shall be used. Cationic PAM is toxic and shall NOT be used**
- PAM and PAM mixtures shall be environmentally benign, harmless to fish, wildlife and plants
- PAM and PAM mixtures shall be non-combustible
- When applying ensure uniform coverage to the target and avoid drift to non-target areas including waters
- Anionic PAM, in pure form, shall have less than or equal to 0.05% acrylamide monomer by weight
- To maintain less than or equal to 0.05% of acrylamide monomer, the maximum application rate of PAM, in pure form, shall not exceed 227kg/ha/year

Polyacrylamide (PAM)

Erosion Control

B.M.P. #36

- Do not over apply PAM
- Seeding rate for all mixes should be 25 kg/ha minimum

Design Considerations

- Excessive application of PAM can lower infiltration rate or suspend solids in water, rather than promoting settling
- Users of anionic PAM shall obtain and follow all Material Safety Data Sheet requirements and manufacturer's recommendations
- Obtain written application methods and rate for PAM and PAM mixtures
- Additives such as fertilizers, solubility promoters or inhibitors, etc., to PAM shall be non-toxic
- Gel bars and logs of anionic PAM mixtures may be used in ditch systems
- Anionic PAM is available in emulsions, powders and gel bars or logs
- The use of seed and mulch for additional erosion protection beyond the life of the anionic PAM is recommended
- Use setbacks when applying anionic PAM near natural waterbodies
- Consider that decreased performance can occur due to ultra-violet light and time after mixing when applying anionic PAM
- In flow concentration channels, the effectiveness of anionic PAM for stabilization decreases
- Never add water to PAM; add PAM slowly to water. If water is added to PAM, "globs" can form which can clog dispensers, signifying incomplete dissolving of the PAM and therefore increasing the risk of under application
- Not ALL polymers are PAM

Inspection and Maintenance

- Reapplying anionic PAM to disturbed areas including high use traffic areas

Similar Measures

- Hydraulic seeding and mulching
- Compost

Description and Purpose

- Compost is the product resulting from the controlled biological decomposition of organic material, occurring under aerobic conditions
- Compost has been sanitized through the generation of heat and stabilized to the point that it is appropriate for its particular application
- Active composting is typically characterized by a high temperature phase that sanitizes the product and allows a high rate of decomposition
- It is followed by a lower temperature phase that allows the product to stabilize while still decomposing at a slower rate
- Compost should possess no objectionable odours or substances toxic to plants
- Compost contains plant nutrients but is typically not characterized as a fertilizer
- May derive from agricultural, forestry, food or industrial residues, bio-solids, leaf and yard trimmings, manure, tree wood, or source-separated or mixed solid waste

Applications

- Compost blanket are commonly used for temporary erosion and sediment control
- The technique is appropriate for slopes up to 2H:1V grade and on level surface
- Only used in areas that have sheet flow drainage patterns (not for areas that receive concentrated flows)
- Compost used on AT projects must meet Canadian Council of Ministers of the Environment (CCME) Guidelines for Compost Quality (trace elements, maturity/stability, pathogens), which are adopted by Alberta Transportation and found on AT Products List (www.transportation.alberta.ca)

Advantages

- Relatively cheap method of promoting plant growth and slope protection

Limitations

- Application of compost may be difficult on steep slopes
- May require spray-on method to apply compost to steep slopes
- Requires specialized blower truck, hose and attachments for blanket installation

Installation

Compost Blanket

Erosion Control

B.M.P. #37

- Slightly roughen (scarify) slopes and remove large clods, rocks, stumps, roots larger than 50 mm in diameter and debris on slopes where vegetation is to be established
- Apply compost at the rates as follows:

| Annual Rainfall/Flow Rate | Total Precipitation | Application Rate for Vegetated Compost Surface | Application Rate for Unvegetated Compost Surface |
|---------------------------|---------------------|--|--|
| Low | 25 mm – 635 mm | 12.5 mm – 19 mm | 25 mm – 37 mm |
| Medium | 635 mm – 1270 mm | 19 mm – 25 mm | 37 mm – 50 mm |
| High | >1270 mm | 25 mm – 50 mm | 50 mm – 100 mm |

- Compost shall be uniformly applied using an approved spreader, e.g., bulldozer, site discharge manure spreaders
- A pneumatic blower unit propels the compost directly at the soil surface, thereby preventing water from moving between the soil-compost interface
- Seeding can be incorporated during the compost application

Construction Considerations

- Use higher blanket application rate in high rates of precipitation and rainfall intensity, and snow melt
- Compost may be used in conjunction with a compost blanket, especially in regions with spring melt, and sites with severe grades and long slopes
- In regions subjecting to wind erosion, a coarser compost product or higher blanket application rate is preferred
- Use lower blanket application rate in lower precipitation rates and rainfall intensity regions

Inspection and Maintenance

- Inspection frequency should be in accordance with the PESC and TESC Plans
- Areas damaged by washout or rilling should be regraded if necessary and re-covered with compost immediately

Similar Measures

- Rolled erosion control products (RECP)
- Hydroseeding
- Hydromulching

Rolls

- a) Coir Roll
- b) Fibre Roll

Streambank Stabilization Techniques and Erosion Control

B.M.P. #38

Description and Purpose

- Coir Rolls are long cylindrical tubes that are composed of interwoven coconut fibres which are bound together with durable coir netting. Coir rolls are particularly applicable for wetland, streambank, and shoreline projects. Coir rolls are most commonly available in 300mm diameters and 6m lengths. These rolls can be linked together to form longer tubes, and are often used in combination with other biotechnical techniques, such as brush layering or live siltation. Coir logs encourage siltation and wetland/floodplain creation
- Fibre rolls are installed across slope contours as a grade break to reduce erosion potential by reducing overland flow velocities
- Straw roll consists of bundled straw (or natural fibre) wrapped in photo-degradable open-weave plastic netting staked into the soil along slope contours as a grade break to reduce erosion potential
- Normally live staking can be installed to anchor the Fibre Rolls to provide deep root vegetation with potential favourable moisture retention provided by fibre roll
- Fibre Rolls also capture sediment, organic matter, and seeds carried by runoff

Applications

- The tough, long-lasting coconut fibres make coir rolls appropriate for wetland, streambank, and shoreline applications. Coir rolls work well when immediate erosion control is needed. Brushlayers work well with coir roll applications, adding further stabilization with a live root system, while also providing excellent habitat features. The coir roll provides a base for the brushlayer cuttings to be laid upon at an appropriate angle which benefits the growth of cuttings. The cuttings provide further protection from breaking waves and high flows
- Fibre Rolls may be used on slopes stable enough to support vegetation (steep, confined, slopes and channel banks with gradients greater than 1H:1V may have low success potential)
- Fibre Rolls may be used along long slopes as a grade break to shorten slope length between line of fibre rolls at different contour elevations
- Fibre Rolls may be used as grade breaks, where slopes transition from flatter to steep gradients

Advantages

- The coir material is natural and long lasting (5 to 7 years), and has high tensile strength

Rolls

- a) Coir Roll
- b) Fibre Roll

Streambank Stabilization Techniques and Erosion Control

B.M.P. #38

- The fibre rolls and mats accumulate sediment while the plants grow and the plant roots develop. Eventually the coir material biodegrades and the cohesive strength of the root systems and flexible nature of the plants become the primary stabilizing element
- The coir roll/brushlayering combination provides immediate shoreline and streambank protection, with additional benefits of riparian enhancement when the cuttings become established
- Coir Rolls address ecological concerns by encouraging vegetation and wildlife habitat, and are an alternative to stone revetments or other structural measures
- The high tensile strength coconut fibres, fibre netting and the wooden stakes used to anchor the material make up the initial structural components of the system, while plant root and top growth increase the strength and baffle effects of the structure
- Fibre Rolls can be used on slopes too steep for silt fences or straw bales sediment barriers
- In time, plastic netting will degrade due to the sunlight and straw will degrade and be incorporated into the soil
- Fibre Rolls primary purpose is erosion control, however fibre rolls do provide some sediment control

Limitations

- This technique should be implemented during the dormancy period of the cuttings used for brushlayering and staking
- Coir Rolls are relatively expensive
- Fibre Rolls are designed for low sheet flow velocities
- Fibre Rolls are designed for short slopes with a maximum gradient of 1H:1V
- Fibre Rolls may be labour intensive to install
- Straw rolls have short life span due to natural degradation
 - Usually only functional for two seasons
- Susceptible to undermining and failure if not properly keyed into the soil
- Labour intensive maintenance may be required to ensure rolls are in continuous contact with the soil, especially when used on steep slopes or sandy soils

Rolls

- a) Coir Roll
- b) Fibre Roll

Streambank Stabilization Techniques and Erosion Control

B.M.P. #38

Construction

- Determine annual water elevation
- Mark the annual water level on a stake driven into the substrate, 0.3 or 0.6 m offshore. Installing the materials and plants at the correct elevation is the most important aspect to assure success of the installation. Determine, on site, where the installation will begin and end
- Determine soil level by laying a straight cutting on the coir roll with approximately 20% of the cutting sticking out past the roll, and with the basal ends dipping down into the soil
- Begin installation at the downstream end (if using in a streambank project)
- Prepare the site for installation of coir roll and coir mats by removing any large rocks, obstructions or material that may prevent the coir from making direct and firm contact with the soil. Coir rolls must be level, installed along a horizontal contour. Place coir rolls parallel to the stream bank or shoreline. It is very important to key the ends of the coir rolls firmly into the shoreline or stream bank, so waves and flows will not scour behind the rolls and compromise the integrity of the structure
- Install the coir roll such that 50 mm of the roll extends above the annual water elevation
- Adjacent rolls shall be laced together, end-to-end, tightly and securely
- If using brushlayer cuttings prepare soil bed behind installed coir rolls for laying. It is important that the bud ends of the live cuttings angle up to some degree from the basal ends. Lay cuttings in this fashion, slightly crisscrossed for additional strength
- Next, backfill over cuttings with soil, covering the lower 80% of the branches. At this time, soil can be levelled and prepared for a soil wrap for additional height and soil stability
- If simply covering the cuttings with soil, compact slightly and grade slope to appropriate angle. Use water to wash soil in between branch layers
- If using plant materials, such as container-grown, pre-rooted plant plugs or willow stakes, they should be planted into the coir rolls and through the coir mats and netting
- To install plant plugs and willow stakes into the coir roll, use a planting iron or pilot bar into the roll and wedge it back and forth to create a hole for the plant. It is extremely important that the root system of the plant be placed below the water

Rolls

- a) Coir Roll
- b) Fibre Roll

Streambank Stabilization Techniques and Erosion Control

B.M.P. #38

level for certain species. All plants shall be checked to ensure that they have been firmly installed in the fibre material

- Mulch and seed exposed areas with native species
- Prepare slope face and remove large rocks or other deleterious materials
- Excavate small trenches a minimum of 0.15 m deep and 0.15 m wide across the width of the slope, perpendicular to slope direction, starting at the toe of the slope and working upwards towards crest of slope
- Space trenches a maximum of 3 to 8 m apart along the slope incline, with steeper slopes having trenches spaced closer together
- Place fibre rolls into trench ensuring continuous contact between fibre roll and soil surface
- Butt-joint adjacent fibre roll segments tightly against one another
- Use a metal bar to make pilot hole through middle of the fibre roll a minimum depth of 0.3 m into underlying soil
- Pilot holes should be spaced a maximum of 1 m apart
- Secure fibre roll to soil using wooden stake or other appropriate anchor; live stake may be used as alternate anchor
- Place soil excavated from trench on upslope side of fibre roll and compact to minimize undermining of fibre roll by runoff
- Seed the soil along the upslope and downslope sides of the fibre roll to promote vegetation growth

Construction Considerations

- All work site disturbance should be minimized. Protect any existing plant, when possible, and avoid additional disturbance that can lead to erosion and sedimentation
- Install additional erosion and sediment control measures such as temporary diversion dikes, silt fences and continuous berms, as needed, before beginning work
- Coir rolls can be used in the stream as a sediment barrier, silt curtain, and/or coffer dam to control sediment while work is being done in the water
- Topsoil should be saved, if possible, and replaced once the subsoil has been removed or regraded. Soil shall be stored away from the water's edge and it shall be moved to its final location and stabilized as quickly as possible

Rolls

- a) Coir Roll
- b) Fibre Roll

Streambank Stabilization Techniques and Erosion Control

B.M.P. #38

- For typical applications at the water's edge, coir rolls are held in place with a single row of stakes, 300 mm on center. Stakes may be driven through the netting on the outer edge of the roll. It is very difficult to drive stakes through the high-density rolls, however, a stake can be driven with the help of a pilot hole through the low density coir rolls
- Lacing among the stakes is recommended for coir mats exposed to extreme conditions such as ice, waves, or flooding
- Coir rolls shall be placed along streambanks or shorelines at a height sufficient to protect the bank from flows or waves. Additional coir rolls may be placed above the lower rolls, in a tile-like fashion, to protect the upper shore or stream bank
- Use live stakes in place of wooden stakes
- If the slope soil is loose and uncompacted, excavate trench to a minimum depth of 2/3 of the diameter of the fibre roll
- For steep slopes, additional anchors placed on the downslope side of the fibre roll may be required

Inspection and Maintenance

- Inspection frequency should be in accordance with the PESC and TESC Plans
- Check plants to ensure that they have been firmly installed in the fibre material
- Water plants, if necessary, during the establishment phase
- Check all materials periodically or after storms to ensure they remain properly secured. Make necessary repairs promptly
- All temporary and permanent erosion control practices shall be maintained and repaired as needed to ensure continued performance of their intended use
- Areas damaged by washout or rutting should be repaired immediately
- Additional stormwater control measures should be considered for rilling areas damaged by runoff

Place coir rolls parallel to the streambank along a horizontal contour.

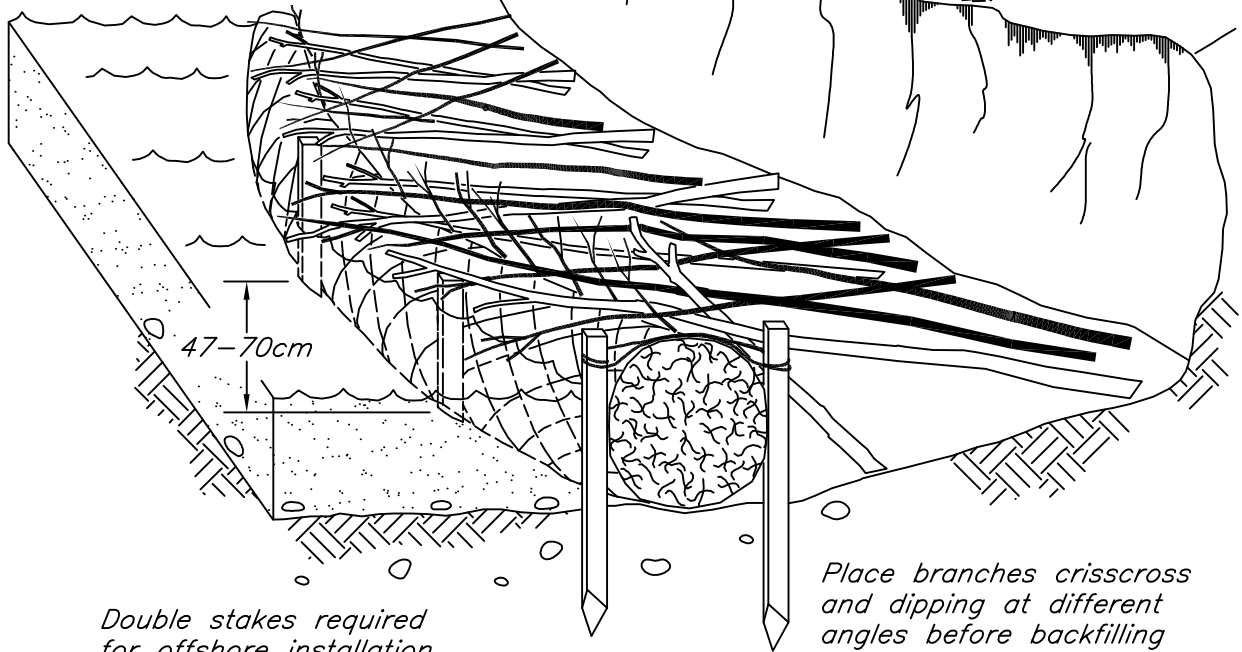

Double stakes required for offshore installation.

Place branches crisscross and dipping at different angles before backfilling behind coir roll.

Place coir roll such that the roll extends 50mm above mean water elevation.

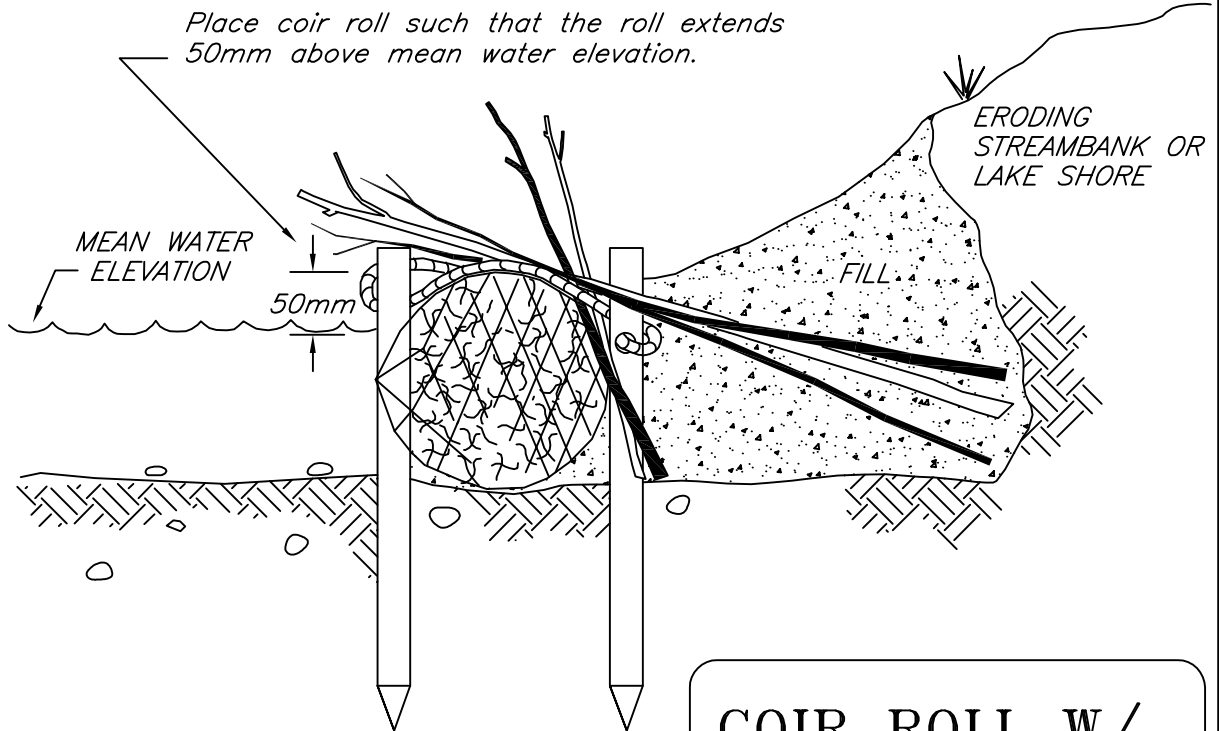

**COIR ROLL W/
BRUSHLAYERING**

© 2000 JOHN McCULLAH

©

FILE: COIRBRLY

PLACE COIR ROLLS PARALLEL TO THE STREAMBANK ALONG A HORIZONTAL CONTOUR

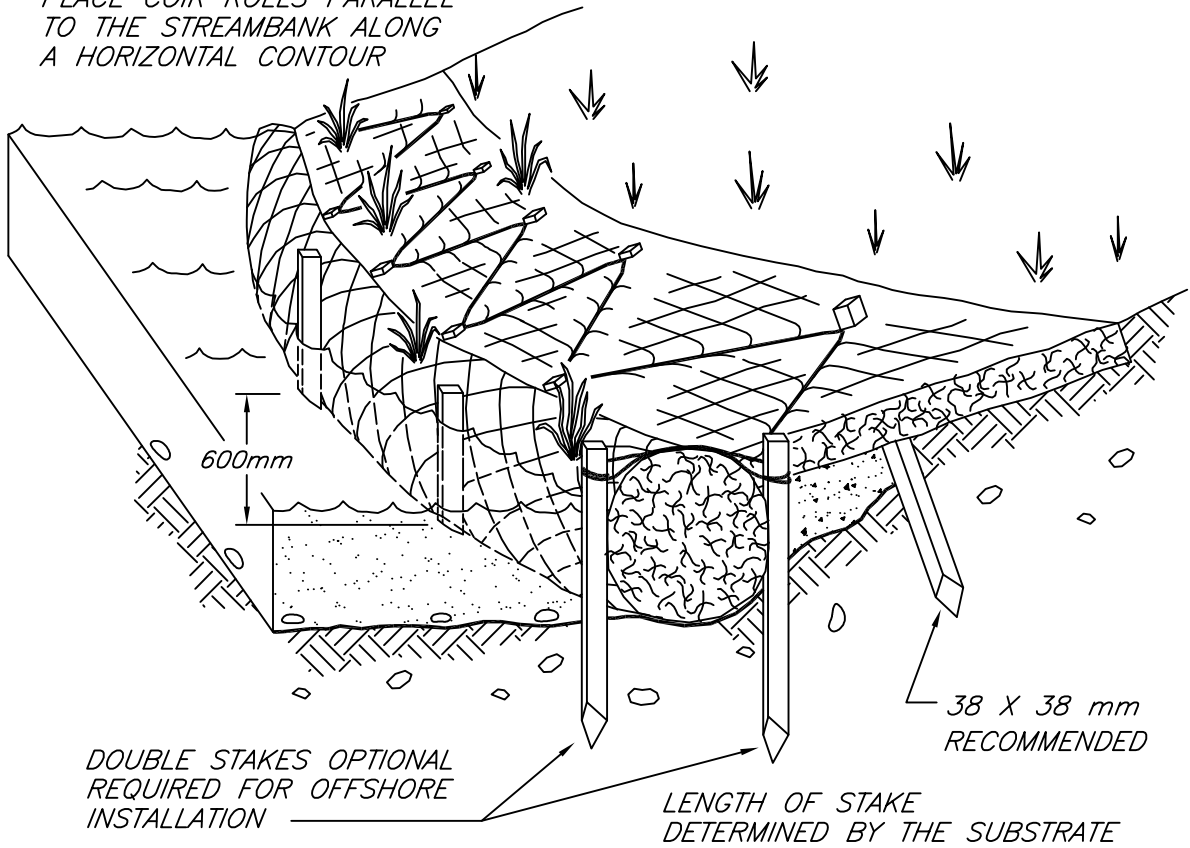

PLACE COIR ROLL SUCH THAT THE ROLL EXTENDS 50 mm ABOVE MEAN WATER ELEVATION

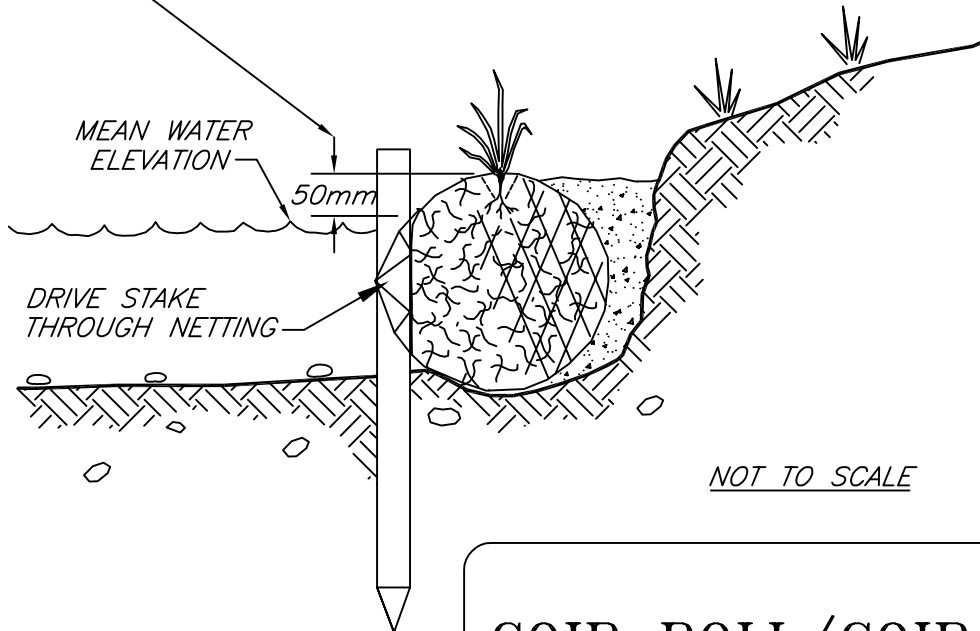

COIR ROLL/COIR MATS

© 1996 JOHN McCULLAH

FILE: COIRRM

STRAW ROLLS MUST BE PLACED ALONG SLOPE CONTOURS

ADJACENT ROLLS SHALL TIGHTLY ABUT

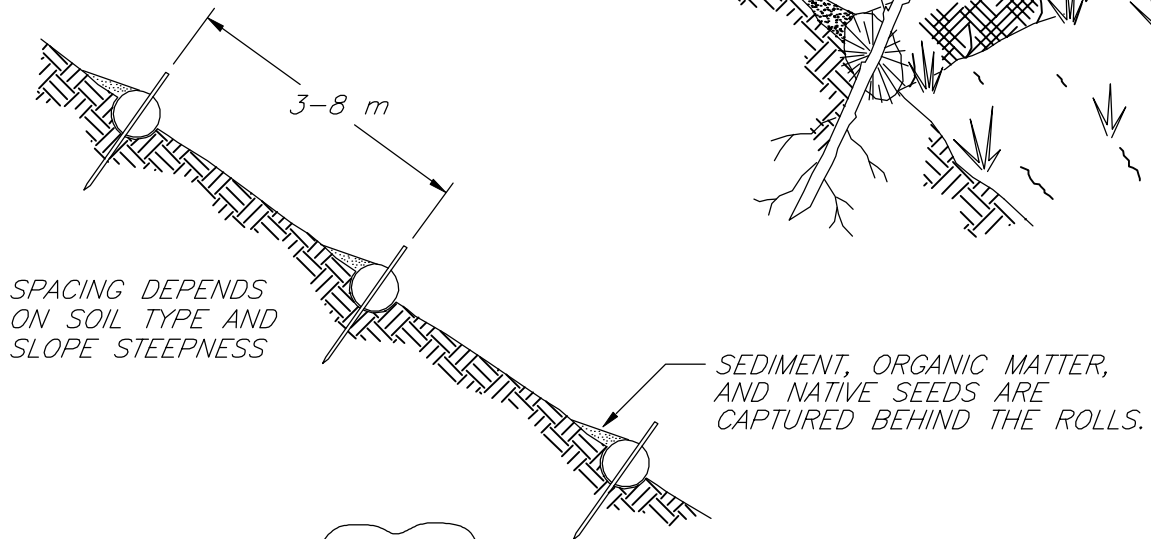

SPACING DEPENDS ON SOIL TYPE AND SLOPE STEEPNESS

SEDIMENT, ORGANIC MATTER, AND NATIVE SEEDS ARE CAPTURED BEHIND THE ROLLS.

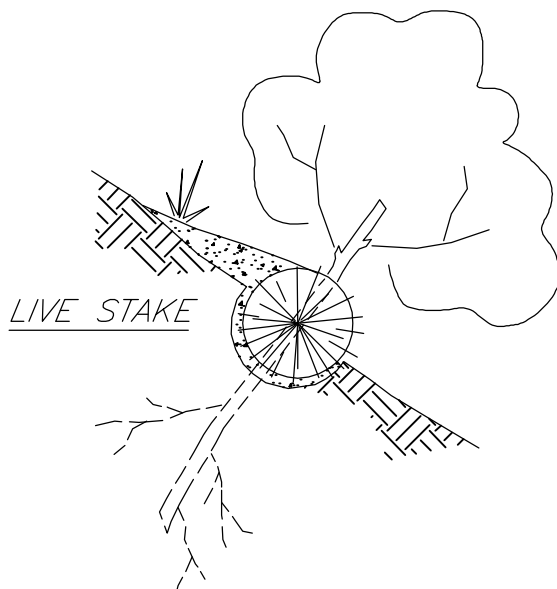

LIVE STAKE

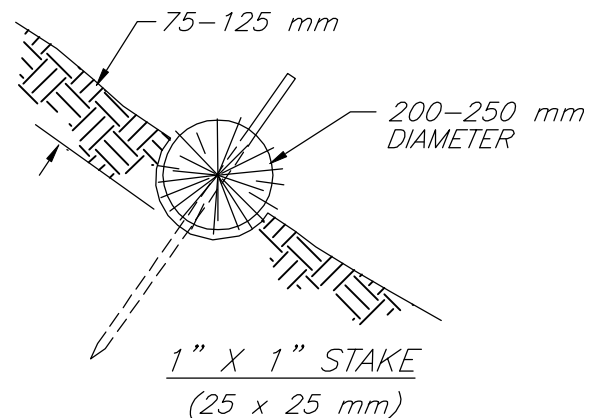

1" X 1" STAKE
(25 x 25 mm)

NOT TO SCALE

NOTE:

1. STRAW ROLL INSTALLATION REQUIRES THE PLACEMENT AND SECURE STAKING OF THE ROLL IN A TRENCH, 75-125 mm DEEP, DUG ON CONTOUR. RUNOFF MUST NOT BE ALLOWED TO RUN UNDER OR AROUND ROLL.
2. THIS FIGURE IS PROVIDED FOR GUIDANCE ONLY AND DOES NOT CONSTITUTE A DESIGN. A SITE SPECIFIC DESIGN IS REQUIRED FROM DESIGNER/ENGINEER.

STRAW
ROLLS

Description and Purpose

- Consists of a thick (15 to 30 cm) blanket of living cuttings and soil fill placed on a streambank or lake shore to simultaneously re-vegetate and armour the bank. It provides scour control and re-vegetation and is constructed using live willow branches or other species that root easily from cuttings. The dense layer of brush increases roughness, reduces velocities at the bank face, and protects the bank from scour, while trapping sediment and providing habitat directly along the waters' edge

Applications

- Appropriate for eroding streambanks or slopes where immediate protection is needed from flooding stream flows or wave-induced erosion
- Willow is the most common plant material used because of its rooting ability
- Suitable for streams where willow is naturally occurring and where the soil and moisture conditions are favourable
- Planted relatively shallow, as compared to brushlayering, therefore it is most successful on streams where the basal ends of the cuttings will be kept moist during most of the growing season, but flows do not exceed the tolerance of the structure

Advantages

- Provide a dense network of branches that quickly stabilize a slope or streambank
- As the live branches root and grow, not only do they provide cover, but the soil is reinforced with an underground matrix of spreading roots
- If used on streambanks, a brush mattress will trap sediments during high water and eventual plant growth will enhance aquatic habitat
- If used on slopes, a brush mattress collects soil, providing germination sites for other plants
- Well suited for combined installation with many other streambank or slope stabilization techniques
- Often combined with Vegetated Riprap, Live Stakes, Live Fascines, Rootwad Revetment, Live Siltation, and Coconut Fibre Rolls
- Provides immediate surface protection against floods, greatly reducing water velocity at the soil surface
- Well-anchored mattress provides some resistance to scour
- Cuttings are usually available locally

- Relatively economical technique
- Captures sediment during floods, assisting in rebuilding of bank
- Produces riparian vegetation rapidly
- Enhances wildlife habitat value

Limitations

- Does not show high success on streams where basal ends cannot be kept wet for the duration of the growing season
- They should be installed during the dormant season for woody vegetation
- Installation is labour intensive

Construction

- Prepare the slope or streambank by clearing away large debris and grading the slope so the branches will lay flat on the bank
- If bank is not graded evenly, air pockets will form during backfilling, causing poor stem to soil contact, and ultimately resulting in poor sprouting
- Do not compact the slope over 85%, as it will inhibit rooting
- Excavate a horizontal trench, 20 to 30 cm deep at the toe of the streambank
- Lay the cuttings flat against the graded slope, slightly crisscrossed, with the basal ends placed as deeply into the trench as possible, and just below any toe protection to be installed
- Continue to lay the cuttings along the face of the bank or slope until 80% groundcover is achieved
- The mattress will be about 6-30 cm thick
- It will take 10 to 50 branches per m of mattress
- Pound a grid of stakes, 60 to 90 cm long, into the mattress at 0.9 to 1.2 m centers
- Do not pound the stakes completely in, as this will be done after tying
- Longer stakes can be used in sandy soil and shorter stakes in heavy soils
- Secure the brush mattress by using cord, rope, or 10 to 12 gauge galvanized annealed wire, tied with clove hitches in a diamond pattern between each row of stakes
- After securing the mattress with cord or wire, drive the stakes in further to compress the mattress tightly against the slope

- Secure the toe of the mattress using a suitable technique such as Vegetated Riprap, Live Fascines, Rootwad Revetments or Coconut Fibre Rolls
- Backfill around and in between the branches of the mattress by using material excavated from the trench, and additional soil if needed
- Work the soil in well around the branches
- Tamp soil by walking on it, and lightly water the soil with buckets or a hose to wash it down into the stems, and ensure good stem to soil contact
- It is necessary for the thicker, basal ends of the mattress to get good soil cover for rooting; at least 1/4 of the depth of the mattress is recommended
- Leaving some branches exposed above the soil will facilitate sprouting

Construction Considerations

- Brushy cuttings (stems having leaves and twigs) of tree and shrub species capable of propagating from cuttings, typically willow species
- 10 to 50 branches per m of bank to be protected should be harvested
- The cuttings should be long (1.5 to 3 m), straight, brushy, 2 to 3 year old branches up to 4 cm in diameter
- For optimum success, the fascines should be soaked for 24 hours or installed on the same day they are harvested and prepared
- Wooden construction stakes and/or live stakes will be needed
- The length of stakes will vary based on soil conditions
- Biodegradable natural fibre or polypropylene rope is usually preferable to wire
- A sledgehammer will be needed for driving in wooden stakes, or a dead-blow mallet and pilot bar (rebar) for live stakes

Inspection and Maintenance

- During the first growing and flood season, periodic maintenance is necessary to make sure the stakes and cord/wire are still securing the mattress to the streambank, and to verify that flows are not getting behind the mattress
- Inspect for flanking or undermining of the revetment

Design Considerations

- The optimal bank slope for brush mattresses is 1V:2H, because stem to soil contact can be maximized at that angle; however, mattresses can successfully be installed at angles of 1V:1.25H or steeper, but sprouting will occur mostly at the basal ends

- In some cases, fill will be required to bring the bank to the desired grade
- If rock fill is used, at least 45 cm of soil should be placed over the rock to ensure proper stem to soil contact for the cuttings
- It is important to protect the brush mattress against flanking and undermining
- Some type of toe protection is necessary, and depending upon the erosivity of the bank, keys or refusals may be necessary at upstream and downstream ends
- Rock toe protection is useful with brush mattresses
- If there is any overbank runoff occurring, flows should be diverted around the brush mattress and outleted in a stable area
- If piping is evident, a granular filter should be installed underneath the brush mattress
- The survival of cuttings that do not have their basal ends near the annual low water level is questionable in arid and semi-arid environments
- Studies have shown that brush mattresses have stabilized a bank in a test flume against velocities exceeding 7 m/s

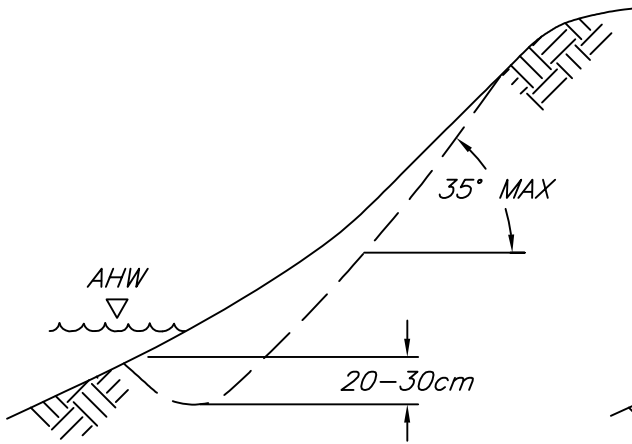

Step 1: Excavate trench and grade bank.

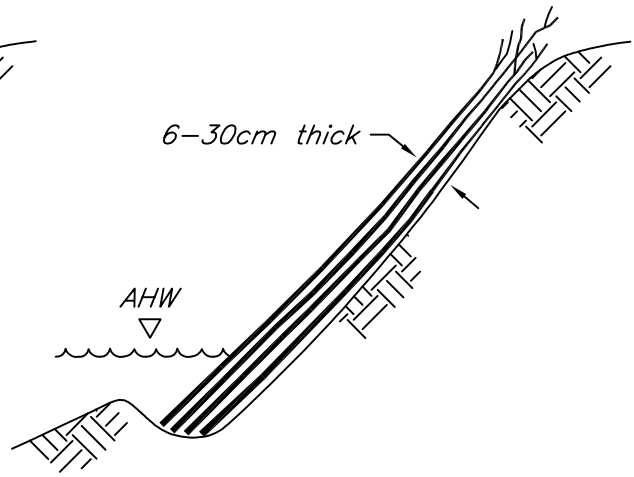

Step 2: Place willow branches making sure that the butt ends reach the bottom of the excavated trench, and are below the mean low water level.

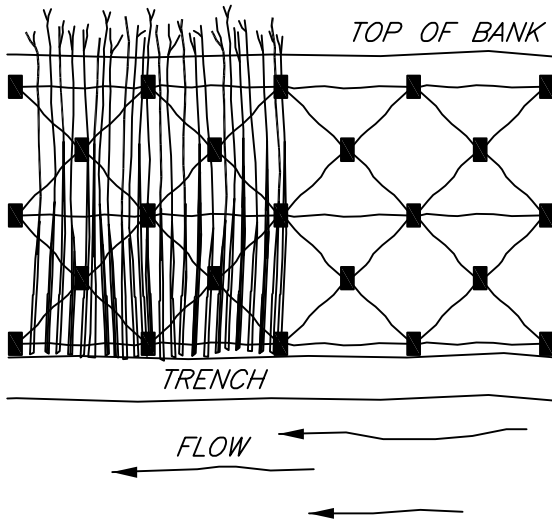

Step 3: Place notched stakes on 1.0m centers, and secure the mattress by lacing twine, rope or wire in a diamond pattern between the stakes.

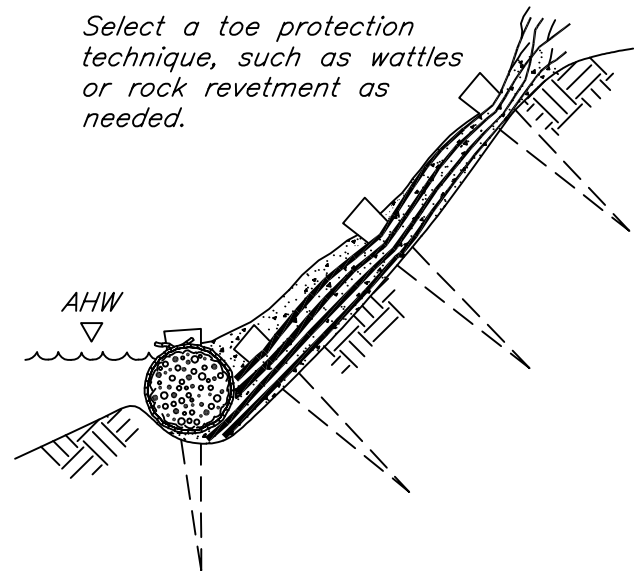

Select a toe protection technique, such as wattles or rock revetment as needed.

Step 4: Drive the stakes deeply into the bank to tightly compress the branches against the soil. Cover and partially bury the mattress to encourage rooting.

BRUSH MATTRESS

Description and Purpose

- A re-vegetation technique used to secure the toe of a streambank, trap sediments, and create fish rearing habitat. It can be constructed as a living or a non-living brushy system at the water's edge and helps to secure the toe of a streambank

Applications

- An appropriate practice along an outer bend with sufficient scour or toe protection

Advantages

- Can be constructed in combination with rock toes, Rootwad Revetments, Coconut Fibre Rolls, Live Fascines, and Brush Mattresses
- A very effective and simple conservation method using local plant materials
- Valuable for providing immediate cover and fish habitat while other re-vegetation plantings become established
- The protruding branches provide roughness, slow velocities, and encourage deposition of sediment
- The depositional areas are then available for natural recruitment of native riparian vegetation

Limitations

- If using a living system, cuttings must be taken during the dormancy period

Construction

- Construct a V-shaped trench at the annual high water (AHW) level, with hand tools or a backhoe
- Excavate a trench so that it parallels the toe of the streambank and is approximately 0.6 m deep
- Lay a thick layer of willow branches in the trench so that 1/3 of the length of the branches is above the trench and the branches angle out toward the stream
- Place a minimum of 40 willow branches per m in the trench
- Backfill over the branches with a gravel/soil mix and secure the top surface with large washed gravel, bundles/coir logs, or carefully placed rocks
- Both the upstream and downstream ends of the live siltation construction need to transition smoothly into a stable streambank to reduce the potential for the system to wash out

- More than one row of live siltation can be installed
- A living and growing siltation system typically is installed at AHW
- A non-living system can be constructed below AHW during low water levels
- If it is impossible to dig a trench, the branches can be secured in place with logs, armour rock, bundles made from wattles, or coir logs

Construction Considerations

- Natural stone, willow wattles, logs or root wad revetments are needed for toe and scour protection
- The live siltation will require live branches of shrub willows 1 to 1.5 m in length
- Branches should be dormant, and need to have the side branches still attached
- Any woody plant material, such as alder, can be installed for a non-living system

Inspection and Maintenance

- Inspection frequency should be in accordance with the PESC and TESC Plans
- During the first year, the installation should be checked for failures after all 1-year return interval and higher flows, and repaired as necessary
- During summer months of the first year, ensure that cuttings are not becoming dehydrated
- Cuttings will not promote siltation if not located at the water's edge
- If located further up the bank, cuttings may dry out, and will only trap sediments and slow velocities during high flows
- Cuttings may not grow well if not handled properly prior to installation

Design Considerations

- Cuttings should be placed adjacent to the water's edge to ensure effective sediment trapping and velocity reduction at the toe of slope
- At least 40 branches per m should be installed
- This technique may be used for velocities up to 2 m/s, but velocities should be at least 0.25 m/s for the system to function properly

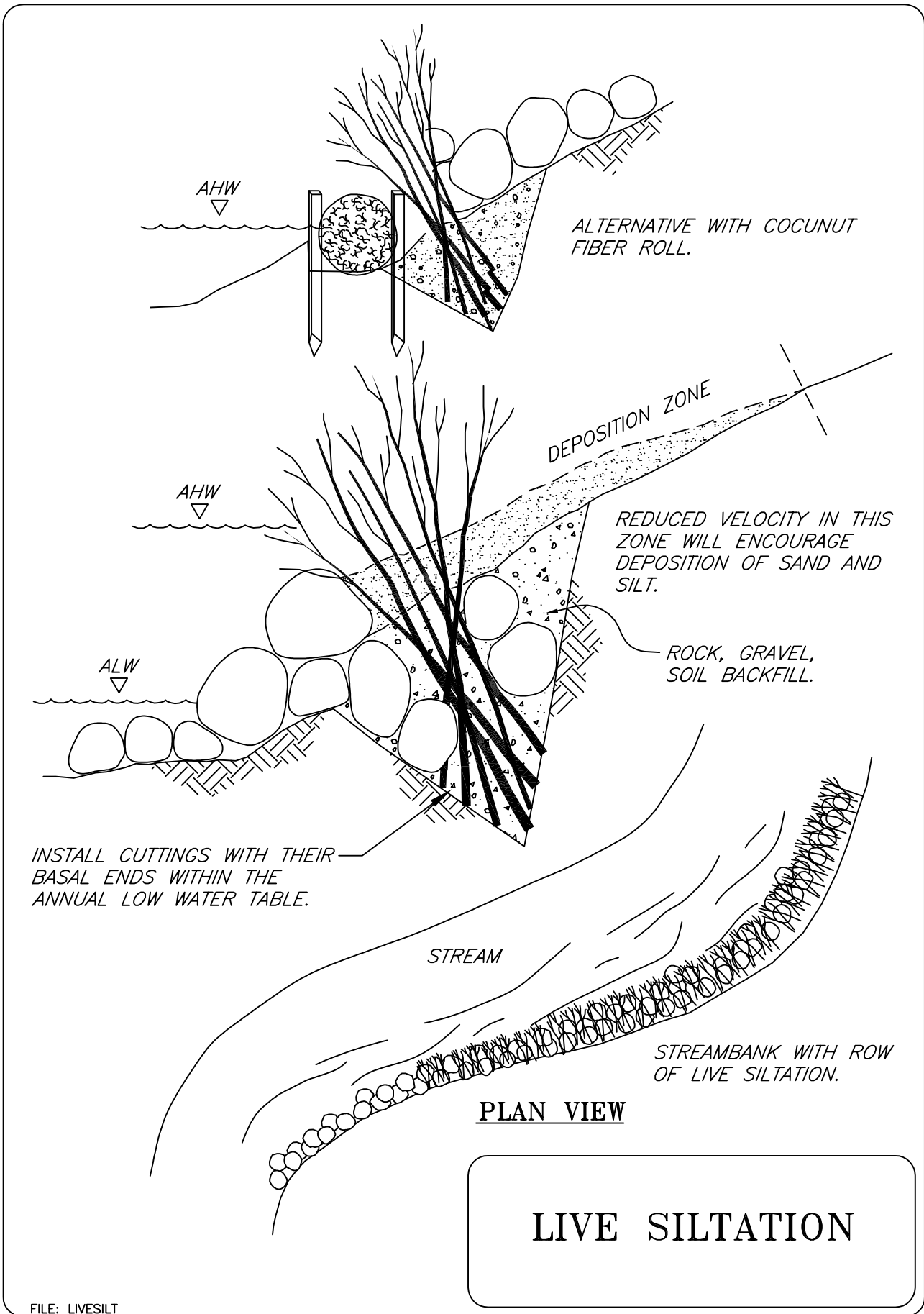

1999 JOHN McCULLAH



FILE: LIVESILT

Description and Purpose

- Willow trees and shrubs may be propagated by planting cuttings
- Although smaller (<4 cm) diameter cuttings (stakes) grow more vigorously than older, larger materials (posts and poles), larger materials provide mechanical bank protection during the period of plant establishment
- Dense arrays of posts or poles reduce velocities near the bank or bed surface, and long posts or poles reinforce banks against mass instabilities occurring in shallow failure planes
- Willow posts and poles can be used in most areas in need of re-vegetation
- Those most conducive to this practice are midbank areas on banks with a 1V:2H slope or shallower
- Although posts and poles can be planted in the toe and upper bank areas, vigorous growth is rare, due to drowning and desiccation of the poles, respectively

Applications

- Willow species are lead pioneers in riparian zones throughout much of North America
- Once established, they provide cover and create conditions conducive to colonization by native species that comprise the riparian community
- Functional riparian zones provide habitats for a wide range of aquatic and terrestrial plants and animals, generally improve bank stability, mediate water quality, and improve visual resources

Advantages

- Willow posts and poles are excellent additions to any technique that requires excavation, particularly when the depth and location of the excavation intercepts soils conducive to willow growth
- Willow posts and poles may be inserted into stone or soil backfill and thus become incorporated with the structure as they root
- They can also be incorporated into many techniques during construction (e.g., Vegetated Riprap, Vegetated Gabions), and can be planted in the keyways of many structures
- When placed along a channel with perennial flow, willows generally will not survive when planted at the toe, but may serve as short-term sacrificial protection for plantings at higher elevations

Streambank Stabilization Techniques

- If permanent protection is needed, structural measures like stone toe are recommended
- Willow posts and poles are inexpensive to acquire, install, and maintain
- Willow posts and poles provide long-term protection
- The mature willows provide canopy cover for aquatic and terrestrial fauna, which also lowers stream temperatures
- Aquatic and terrestrial habitat is provided and/or improved
- Willows act as pioneer species, and allow other plant species to colonize the area after the willows have become established

Limitations

- Willows generally do not grow into the stream or above the top of bank
- Willow posts and poles have higher survival rates when planted during their dormant season, so planning should be adjusted accordingly
- Optimum stabilization is not achieved until the willows become established, typically at least one season after installation, although they provide some reinforcement immediately following installation

Construction

- Poles and posts should be deeply (1 to 2 m) planted in holes created using a metal "stinger" mounted on a hydraulic hoe, or an auger

Construction Considerations

- Willow poles, approximately 5 to 15 cm in diameter, and 1.8 to 3 m in length
- Optimum hole digging equipment is a backhoe with "Waterjet Stinger", normal Stinger or auger
- An excavator bucket can also be used

Inspection and Maintenance

- Inspection frequency should be in accordance with the PESC and TESC Plans
- Willow posts should be inspected for vigor, dehydration, and animal browsing problems
- Desiccation and browsing are the two biggest reasons for failure
- Often, willow post installations need to be fenced for a year or so, especially in agricultural areas, to allow the willows to get established

- Willows that are not planted deeply enough, have too much of their stem exposed, or do not have good stem to soil contact can dry out and die before getting established

Design Considerations

- Willow cuttings should be planted while dormant, and care should be taken to prevent desiccation or dormancy break of cuttings between harvest and planting
- Poles and posts should be deeply (1 to 2 m) planted in holes created using an auger or metal "stinger" mounted on a hydraulic hoe, or an excavator bucket
- Poles should be planted to such a depth that desiccation does not occur during summer (for sites with water tables lower than the stream) and poles are not undermined by local scour during high flows
- Augered holes offer the advantage that soils adjacent to the planted stem are not compacted
- Good contact between the plant stem and soils is essential, so holes that do not collapse must be refilled with compacted soil to prevent desiccation of the plants due to air pockets
- High flows that occur shortly after planting can ensure collapse of the holes and filling of air pockets
- Water jetting, in which stems are rapidly inserted into soils that are locally liquefied using a high-pressure stream of water, offers many advantages over other planting techniques when applied to sandy soils
- Only a small portion of the pole should remain above the surface of the ground – about 80% of the cutting should be buried, to prevent desiccation and ensure good stem to soil contact
- Willow success is governed by soil texture and moisture regime
- Workers in drier climates have stressed the importance of planting willow posts deeply enough to maintain contact with groundwater throughout the growing season

CONSTRUCTION TECHNIQUES

Plant poles deeply during construction of biotechnical streambank work.

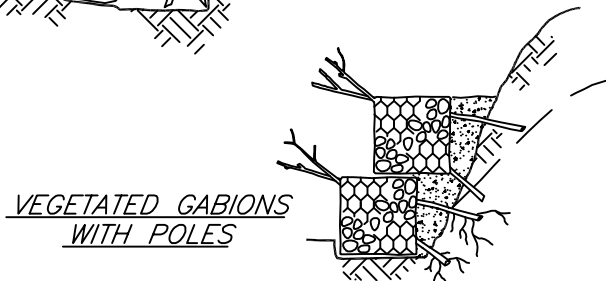
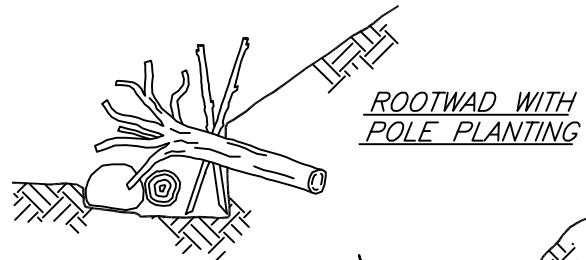
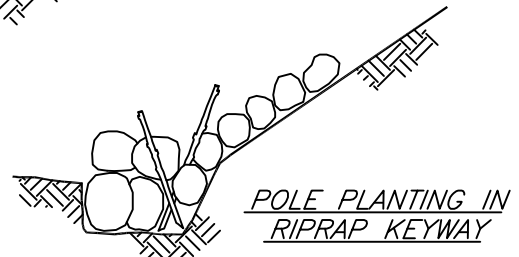
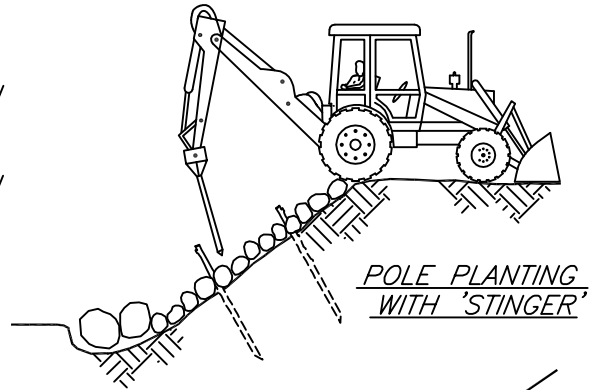
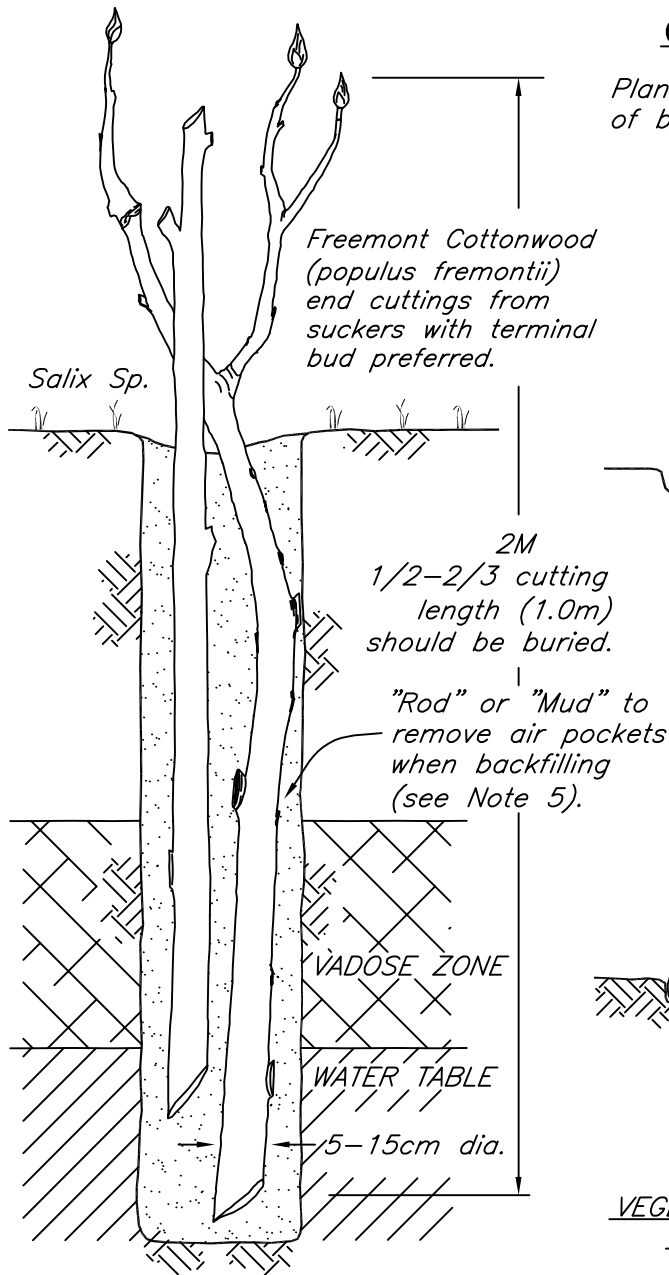

NOTES:

1. Pole cuttings of willow or cottonwood are longer and have a larger diameter than branch cuttings or live stakes.
2. Larger diameter cuttings have a greater supply of stored energy (stored photosynthesis) than smaller diameter cuttings.
3. Pole cuttings are better suited for highly erodible areas and sites with fluctuating water levels.
4. The pole cuttings should extend through the vadose zone and into the permanent water table. At least 1/2 to 2/3 of the pole should be below the ground, at least 1.0m, and long enough to emerge above adjacent vegetation.
5. "Muddying" - filling the hole with water and then soil to make a mud slurry can remove air pockets.

WILLOW POSTS & POLES

Description and Purpose

- Vanes are redirective, discontinuous, transverse structures angled into the flow in order to reduce local bank erosion by redirecting flow from the near bank to the center of the channel
- The instream tips of the structures are typically low enough to be overtopped by all flows and crests slope upward to reach bankfull stage elevation at the bank
- Structures angled upstream redirect overtopping flows away from the protected bank
- Vanes are installed to provide toe protection and rectify lateral instability by redirecting flow away from eroding banks, while providing greater environmental benefits than stone blanket or revetment
- Vanes can increase scour at the tips, backwater area, edge or shoreline length, and the diversity of depth, velocity and substrate
- When properly positioned, a vane deflects flow away from the bank and induces deposition upstream and downstream of the structure
- This redirection of flow reduces velocity and shear stress along the bank while creating a secondary circulation cell that transfers the energy toward the middle of the channel
- Rock vanes, protruding 1/3 bankfull width into the channel and oriented at an upstream angle between 20° and 30°, move the thalweg an average of 20% bankfull width away from the eroding bank. Therefore, vanes, whether made of rock and/or logs, redirect water away from streambanks into the center of the channel
- This serves to decrease shear stress on banks, as well as creating aquatic habitat in the scour pools formed by the redirected flow
- By increasing shear stress in the center of the channel, the vanes create a stable width/depth ratio, maintain channel capacity and maintain sediment transport capacity and competence
- J-hook vanes can also be paired and positioned in a channel reach to initiate meander development or migration

Applications

- Vanes are installed on the outside of stream bends where high velocity and shear stress is causing accelerated bank erosion
- Can often be used at sites where riprap revetments are traditionally applied but greater environmental benefits are desired
- Vanes and other redirective, discontinuous practices should be applied with caution to project sites where infrastructure is immediately adjacent to the protected bank
- Can be combined with longitudinal stone toe or toe or vegetated riprap if continuous resistive protection is also necessary
- Vanes have been successfully installed in rivers and streams with bankfull widths ranging from 9 m to 150 m, with gradients between 0.05 to 0.0003, and in a variety of bed materials
- The ability of vanes to redirect flows and shift local scour and stream power to the center of the channel makes the technique particularly effective where bridge infrastructure is threatened by scour or flanking
- Vanes can be used where it is necessary to preserve as much of the existing bank vegetation as possible, and where aquatic habitat and substrate complexity is an important consideration
- Unlike riprap revetment, which requires reshaping of the bank for installation, vanes require bank disturbance only where keys are placed. This provides opportunities for using vanes in combination with soil bioengineering techniques

Advantages

- Since rock vanes can successfully reduce near-bank velocities and shear stress, vegetation establishment is greatly improved
- Vanes are often combined with other biotechnical soil stabilization measures for bank areas between the vanes
- Vegetated ground cover techniques such as Turf Reinforcement Mats, Erosion Control Blankets, Live Stakes, Live Brush Mattress, and Vegetation Alone are appropriate candidates for combination
- Rock vanes are sometimes used in conjunction with continuous and resistive armouring measures, such as Cobble or Gravel Armour, Vegetated Riprap or Longitudinal Stone Toe, when additional protection between the vanes is required
- Live Brushlayering, Willow Poles, and Live Siltation are extremely effective when implemented at the bank during excavation of the keyways

- Posts and Poles can be used to create overhanging cover for pools up- or downstream from cross vanes
- Intermittent structures such as vanes provide aquatic habitats superior to resistive, continuous structures like Riprap and Longitudinal Stone Toe
- Controlled scour at the vane tip, the creation of pool/riffle bed complexity, and increased deposition of the upstream end are the major environmental benefits of vanes
- Vanes provide fish rearing and benthic habitat, creates or maintains pool and riffle habitat, provides cover and areas for adult fish, and velocity refugia
- Using a redirective measure instead of a continuous, resistive bank armouring technique has several advantages
- Vane installation can often be accomplished from the top of the bank, and does not require bank regrading, which minimizes the impacts to existing vegetation and reduces the amount of site disturbance needed for installation
- The redirection of impinging flows away from the bank and the sedimentation on the upstream side of the vane creates areas where vegetation can effectively re-establish. Thus, areas of active bank erosion become depositional, vegetate, and subsequently, become permanently stable
- Vanes can be used to reduce streambank erosion, rectify lateral instability, and modify flow direction and local scour, while simultaneously gaining environmental benefits
- The technique is appropriate under a range of flow conditions and bed materials and can be used in series to redirect flows around bends
- Vane installation does not require extensive bank reshaping, and most heavy equipment work can be done from the top of the bank, further reducing site disturbance
- Vanes require less rock and heavy equipment than riprap for a similar length of protected bank
- When used to protect bridge infrastructure, vanes placed upstream of abutments force the thalweg toward the center of the channel

Limitations

- Unintended impacts can result from improper design and construction
- If the vane is not properly keyed into the bank, it is likely to fail, creating new localized erosion problems

- Improper vane angle and crest elevation can redirect flow in unintended directions, triggering downstream erosion

Construction

- Construction will require excavation of a key into the bank at minimum of 3 m to a height of bankfull elevation
- If the bank is higher than bankfull, a bench at bankfull elevation can be built to key in the vane
- The keyways should be constructed by digging a trench, placing rock and installing vegetation, and backfilling
- If vegetative techniques are used, such as Willow Post and Poles or Live Siltation, the chances of successful establishment can be increased by "watering in" the cuttings
- Self launching rock can be placed on the existing substrate, however, if footer rocks are necessary, then excavation of the trench for the footer rocks will be required
- The depth of the trench varies depending on bed material
- For a gravel or cobble bed stream, a depth of twice the diameter of the average vane rock is recommended for the footer trench
- The footer rocks should be placed with a gap between the stones equal to 1/3 their diameter which allows them to interlock as the vane adjusts and equilibrates
- In sandy bed material, or where excessive scour is predicted, the trench depth should be four times the diameter of the average vane rock and the gaps between the rocks should be eliminated
- It may be feasible to place a filter fabric geotextile under the footer stones on sand-bed streams

Construction Considerations

- Vanes are generally constructed with graded rock; however, successful vanes have also been constructed from single logs and log cribs with stone fill
- An excavator or backhoe is usually needed to construct the keyways and place the vane rocks

Inspection and Maintenance

- Inspection frequency should be in accordance with the PESC and TESC Plans
- The vane should be inspected regularly

- Maintenance staff should determine:
 - Is the vane intact?
 - Are flows being redirected where expected?
 - Is there any unintended scour?
 - Is there deposition on the upstream side of the vane?
 - Has the vane (or vane series) created or exacerbated erosion or lateral instability downstream of the structure?
- If the vane is not properly keyed into the bank, it is likely to fail, creating new localized erosion problems
- Improper vane angle and height can redirect flow to unintended places, creating further bank erosion downstream of the structures

Design Considerations

- Regardless of project goals, the key design/construction elements of vanes are length, angle, crest elevation, slope, rock size, the placement of appropriate footer rocks, and vane spacing if using the structures in series
- **Hydraulic Considerations:**
 - The primary hydraulic design consideration for vanes is the water surface elevation of bankfull stage
 - Cross vanes are independent of design high-water and freeboard and vegetation establishment is the most common bank protection from bankfull stage to top of bank.
- **Length:**
 - The vane should extend 1/4 to 1/3 the bankfull width of the channel
 - However, this maximum applies to small streams; the larger the channel, the shorter the vane should be relative to the channel width.
- **Angle:**
 - Optimum results are obtained when the vane is oriented upstream at an angle with the protected bank between 20° and 30°. A 20° angle requires a longer vane, but protects a greater length of bank
 - When orienting vanes for the specific goal of protecting bridge infrastructure, i.e., directing flow through and reducing scour at bridge abutments, a 30° angle is generally more effective at reducing scour at the abutment and moving maximum scour depth toward the center of the channel than the 20° angle

- **Height:**
 - The crest elevation of the bank end of the vane should be equal to the bankfull or AHW stage elevation
 - The key into the bank is also designed to bankfull elevation
 - The vanes must be keyed into the bank at least 3 m
 - If the bank is higher than bankfull, build a bench at bankfull elevation to key in the vane
- **Crest Slope:**
 - Vanes are designed to be overtopped at the tip by all but the lowest flows and should pitch from the bank to the tip of the vane with a 3 to 7% slope
 - Steeper vanes act more like spurs or barbs and have different effects on scour and velocity
- **Rock Gradation and Shape:**
 - When possible, vanes should be constructed with graded (self-launching) stone. Self-launching stone will automatically stabilize the toe of the structure in any scour holes that form
 - Where additional scour is anticipated, more stone may be added to widen the weir crest
 - In this way, stone may be sacrificed without modifying the crest elevation
 - Weirs and vanes placed on sand beds devoid of gravel may subside as sand is washed from beneath the stone; this problem may be addressed by placing filter fabric or a filter layer of finer stone underneath the stone spur
 - In very sandy-bottomed streams, it is advantageous to build vanes using "shot rock" or well-graded stone that includes fines, as they prevent 'through-flow' of sand, and subsequent scour
- **Rock Size:**
 - The size of the rock will depend upon the stream size and shear stress
 - See comments below under "Hydraulic Loading" on rock sizing.
- **When to use footers:**
 - The footer rocks should be heavier, longer, and flatter than the average vane rocks

- As a rule of thumb, the weight of the heaviest footer rock is comparable to the heaviest rock used for riprap for the design flow
- In sandy streams an extra layer of footer rocks may be necessary to compensate for the additional scour
- Even in small sand bed streams, 2 m of scour next to a structure like this is not uncommon
- **Spacing:**
 - The distance from the convergence point of impinging flows along the eroding bank (or upstream corner of a bridge abutment) to the upstream tip of the vane should be twice the channel width
 - When using vanes in series, the spacing between the upstream tips of the vanes should also be twice the channel width
 - When using vanes in a series along an outer bend, the upstream vane should be located at the point where impinging flows are first causing erosion
 - The second vane is to be located at the point on the bank that will be impacted by the redirected flows
 - This method of spacing requires that the design be based on the flow angles, flow depth and flow direction from the anticipated design storm stage
 - As a general rule, small to moderate rivers, less than 20 m wide and where the vane projects approximately 1/3 the width, require spacing that is approximately twice the channel width
 - Permissible shear and velocity for rock vanes is related to the size of rock used in construction
 - Other factors, such as the angularity of the stone, the thickness of the layers of stone, and the angle at which the faces of the stone structure are constructed also come into play
 - The Maynard (1995) equation gives a D_{50} stone size for an angular stone riprap revetment of 0.875 m if the near-bank vertically-averaged velocity is 3.5 m/s, and flow depth = 1 m, and stone is placed on a bank slope of 1V:1.5H
 - Use of riprap larger than this is unusual

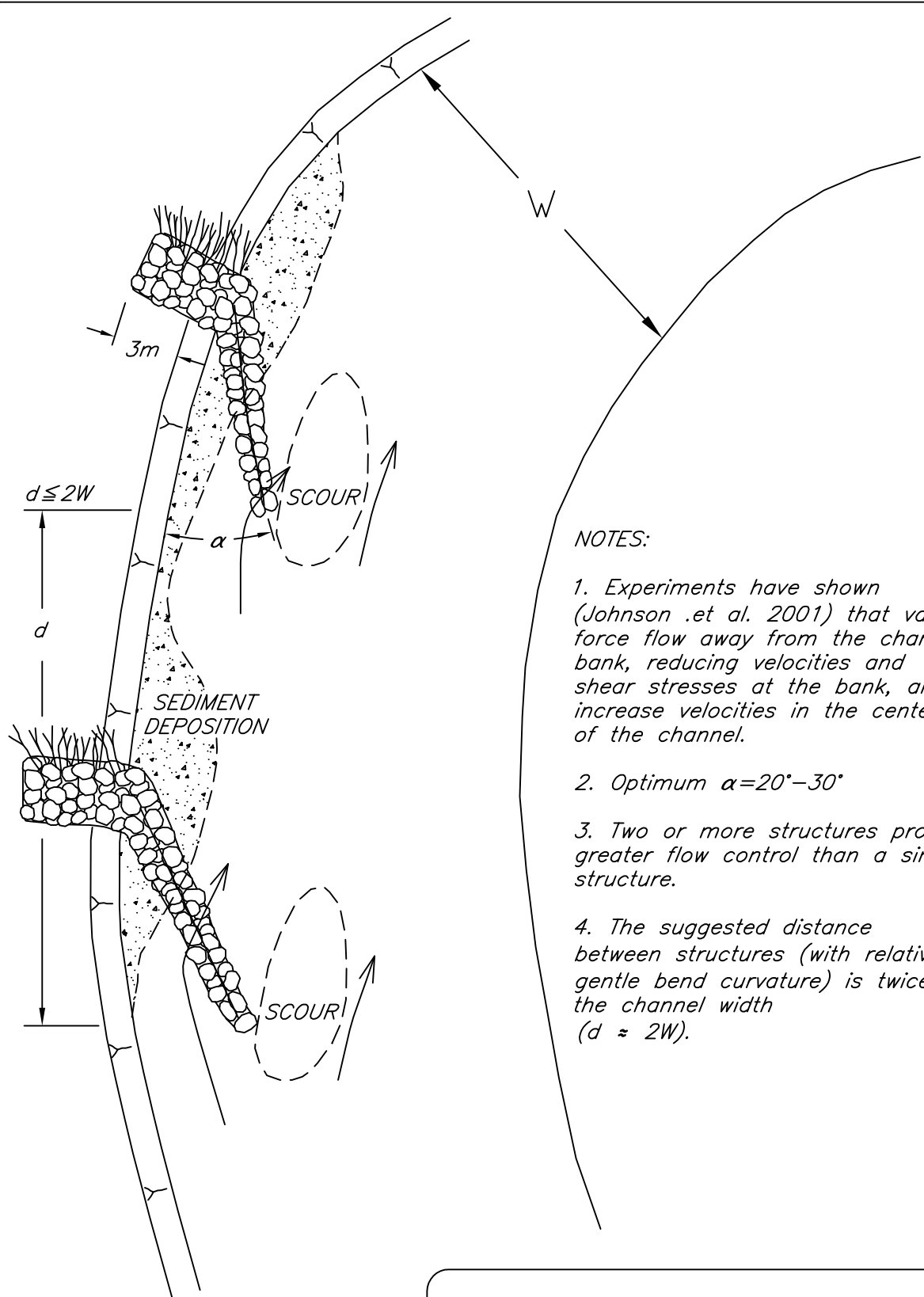

NOTES:

1. Experiments have shown (Johnson .et al. 2001) that vanes force flow away from the channel bank, reducing velocities and shear stresses at the bank, and increase velocities in the center of the channel.
2. Optimum $\alpha=20^{\circ}-30^{\circ}$
3. Two or more structures provide greater flow control than a single structure.
4. The suggested distance between structures (with relatively gentle bend curvature) is twice the channel width ($d \approx 2W$).

TYPICAL VANE

© 2004 SALIK

FILE: ROCK VANE

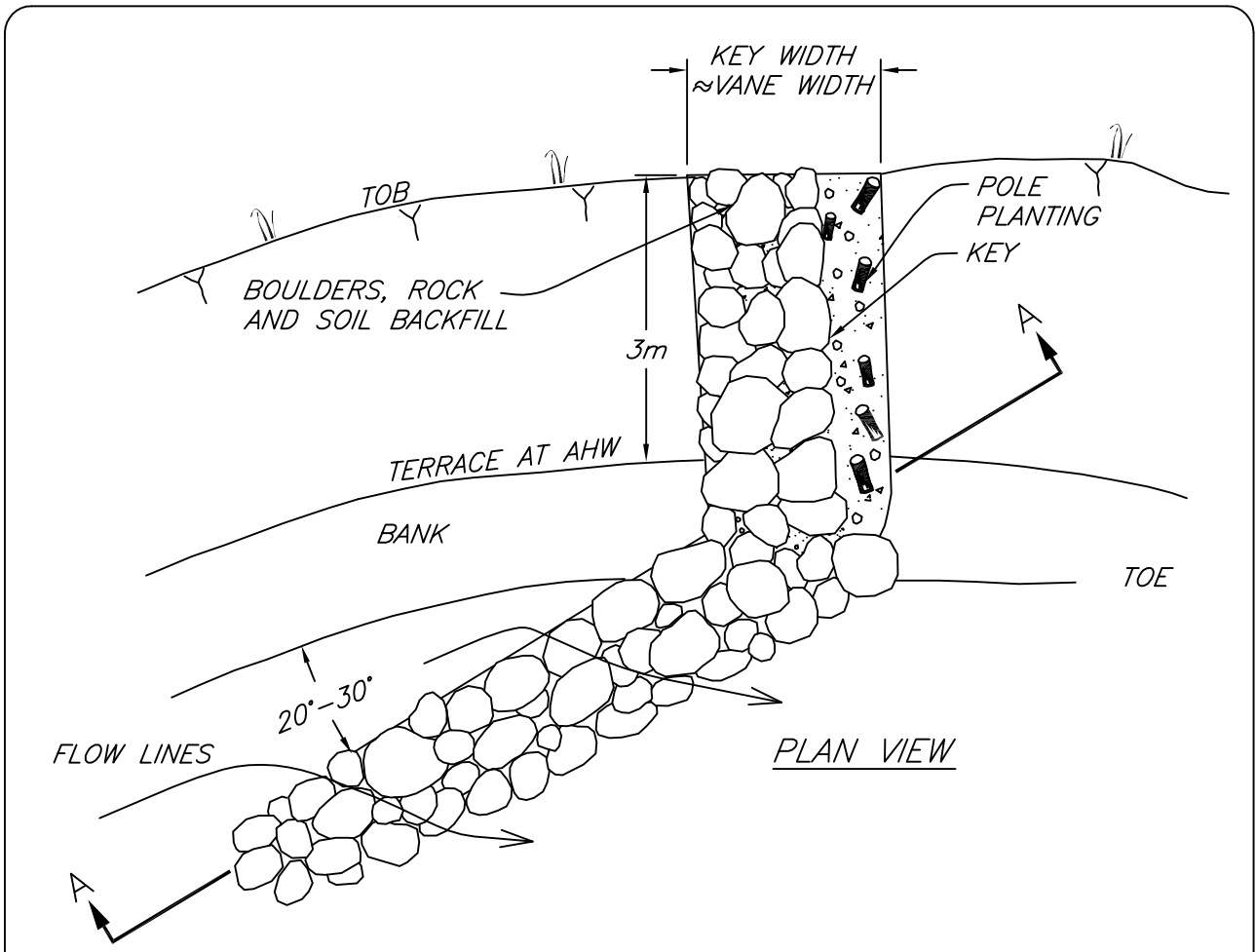

Raising vane height 15cm above AHW elevation will provide additional hydraulic control.

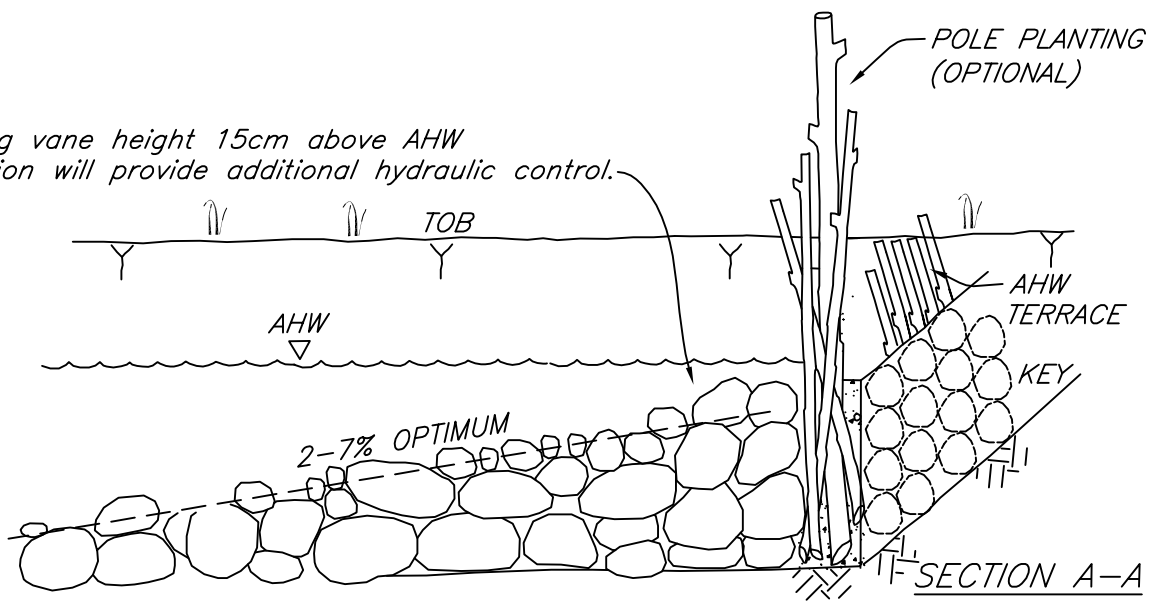

Relatively large, flat footer rocks should be placed as deep as the deepest anticipated scour along the thalweg, or 2 vane rock diameters below the vane rocks, whichever is greater. Inordinate scour can be mitigated by placing a stone or geotextile under layment, or by using self-launching (graded) stone.

**TYPICAL VANE BANK
KEY DETAIL
(WITH POLE PLANTING)**

© 2004 SALIK

FILE: ROCK VANE-BANK KEY DETAIL

Description and Purpose

- Stone toe is continuous bank protection consisting of a stone dike placed longitudinally at, or slightly streamward of the toe of an eroding bank
- Cross-section of the stone toe is triangular in shape
- Success of this method depends upon the ability of stone to self-adjust or "launch" into any scour holes formed on the stream side of the revetment
- Does not need to follow the bank toe exactly, but should be designed and placed to form an improved or "smoothed" alignment through the stream bend. The "smoothed" longitudinal alignment results in improved flow (less turbulence) near the toe of the eroding bank
- It is especially effective in streams where most erosion is due to relatively small but frequent events
- It protects the toe so that slope failure of a steep bank landward of the stone toe will produce a stable angle
- Such a bank is often rapidly colonized by natural vegetation

Applications

- Longitudinal stone toe can be applied in some situations where the bankline needs to be built back out into the stream, where the existing stream channel needs to be realigned, where the outer bank alignment makes abrupt changes (scallops, coves, or elbows), or where the stream is not otherwise smoothly aligned

Advantages

- A variety of techniques can be used with Longitudinal Stone Toe
- Willow posts and poles may be incorporated into key sections and used to re-vegetate the middle and upper bank above stone toe
- Longitudinal stone toe has proven cost-effective in protecting lower banks and creating conditions leading to stabilization and re-vegetation of steep, caving banks
- Live Siltation, Live Brushlayering, Live Brush Mattresses, Live Staking, Live Fascines, Turf Reinforcement Mats, Erosion Control Blankets, Geocellular Containment Systems, Vegetated Articulated Concrete Blocks, Vegetated Riprap, Soil and Grass Covered Riprap, and Vegetated Gabion Mattress may all be used to provide rapid re-vegetation and additional protection on middle and upper banks
- Cobble or Gravel Armour, Vanes with J Hooks, Cross Vanes, Boulder Clusters, and Newbury Rock Riffles may be used to enhance benthic and water column habitats

Streambank Stabilization Techniques

- Longitudinal Stone Toe with Spurs is a variation on this technique
- It has documented environmental benefits, especially for aquatic habitat
- Stone interstices provide cover and habitat for smaller fish and other organisms, and rocky surfaces provide stable substrate for benthic invertebrates. However, fish habitat provided by Longitudinal Stone Toe has been found generally inferior to that provided by intermittent, redirective measures like Spur Dikes, Vanes, or Bendway Weirs
- Vegetative cover can become established, even growing through the rock, and can provide canopy and a source of woody debris
- Bank grading, reshaping, or sloping is usually not needed (existing bank and overbank vegetation need not be disturbed or cleared), nor is a filter cloth or gravel filter needed
- If stone is placed from the water side, existing bank vegetation need not be disturbed
- It is very cost-effective and is relatively easy to construct
- It is simple to design and specify
- It is easily combined with other bank stability techniques that provide superior habitat compared to pure riprap

Limitations

- Only provides toe protection and does not protect mid- and upper bank areas
- Some erosion of these areas should be anticipated during long-duration, high energy flows, or until the areas become otherwise protected
- Stone toe is not suitable for reaches where rapid bed degradation (lowering) is likely, or where scour depths adjacent to the toe will be greater than the height of the toe

Construction

- Longitudinal stone toe should be constructed in an upstream to downstream sequence
- Requires heavy equipment for excavation of the keys (tie-backs) and efficient hauling and placement of stone
- Can be constructed from within the stream, from roadways constructed along the lower section of the streambank itself, or from the top

- The preferred method is from the point bar side of the stream (especially possible with ephemeral or intermittent streams), as this causes the least disturbance of existing bank vegetation
- The least preferred is from the top of the bank, as it disturbs or destroys more bank vegetation and the machine operator's vision is limited
- Usually, the keyways are excavated first and rock is dumped into the key
- The rock is then formed into tie-backs (if needed) and finally the stone toe is constructed along a "smoothed" alignment, preferably with a uniform radius of curvature throughout the bend
- In a multi-radius bend, smooth transitions between dissimilar radii are preferred

Construction Considerations

- Stone for the structure should be well graded and properly sized
- The Maynard (1995) equation gives a D_{50} stone size for an angular stone riprap revetment of 0.875 m if the near-bank vertically averaged velocity is 3.5 m/s, and flow depth = 1 m, and stone is placed on a bank slope of 1V:1.5H

Inspection and Maintenance

- Inspection frequency should be in accordance with the PESC and TESC Plans
- Stone toe structures rarely require maintenance
- Maintenance and monitoring requirements should be linked to consequences of failure
- Features that should be monitored are similar to those for all stone structures:
 - Loss of stone due to subsidence, leaching of underlying sediments, ravelling or excessive launching
 - Extreme scour or bed lowering on the stream side of the toe can cause the entire mass of stone to launch, creating an opening or gap in the longitudinal structure
 - If this situation is anticipated or encountered, the problem can be remedied by adding more rock for additional width
 - Longitudinal stone toe may be flanked during extremely high flows if the key trenches are incorrectly built or if the tiebacks are spaced too widely or are constructed with inadequate amounts of stone
 - These terminal key trenches at the upstream and downstream ends should be excavated into the bank at an angle of approximately 30° with the primary flow

direction and of sufficient length that flows will not be able to get around them during the design storm

Design Considerations

- Longitudinal stone toe can be specified by weight per unit length or to a specific crest elevation
- A specific crest elevation may be specified when the bed of the stream is uneven or deep scour holes are evident
- Longitudinal fill stone toe or weighted riprap toe are similar to stone toe except that the cross-section may be rectangular rather than triangular or peaked
- The dimensions for the weighted riprap toe are based on projected scour depth and a minimum "thickness", which corresponds to stone toe height of 2.5 to 4 times the maximum stone diameter - about 1 to 1.5 m
- Longitudinal stone toe side slopes should be equal to the angle of repose
- Typically stone toe applied at a rate of 3 metric tons of stone per lineal m of protected bank will have a height of approximately 1 m
- Stone toe constructed with 6 metric tons/m stands approximately 1.5 m tall, whereas 1.5 metric tons/m is approximately 0.6 m tall
- Longitudinal stone toe must be keyed deeply into the bank at both the upstream and downstream ends and at regular intervals along its entire length
- On small streams, 25 to 30 m spacing between keys (tie-backs) is typical, while on larger streams and smaller rivers, one or two multiples of the channel width can be used as a spacing guide
- Excavation of trenches for keys provides a good opportunity for deep planting willow posts or poles
- The toe itself does not need to be keyed into the streambed because of its ability to "self-launch"
- However, in areas where the bed of the stream is uneven or deep scour holes are evident, the crest of the structure should be constructed to a specific elevation
- The key trenches at the upstream and downstream ends should be excavated into the bank at an angle of approximately 30°, with the primary flow direction and of sufficient length that flows will not be able to get around them during the design storm
- A gentle angle is important for the end keyways, often referred to as "refusals", because it allows for smooth flow transitions coming into and flowing out of the treated reach

| | |
|---|------------|
| Longitudinal Stone Toe Streambank Stabilization Techniques | B.M.P. #43 |
|---|------------|

- Tiebacks or "refusals" oriented at 90° to the bank have resulted in many failures at the downstream end of the structure, due to flow expansion at that point
- Permissible shear and velocity for longitudinal stone toe is related to the size of rock used in construction
- Other factors, such as the angularity of the stone, the thickness of the layers of stone, and the angle at which the faces of the stone structure are constructed also come into play

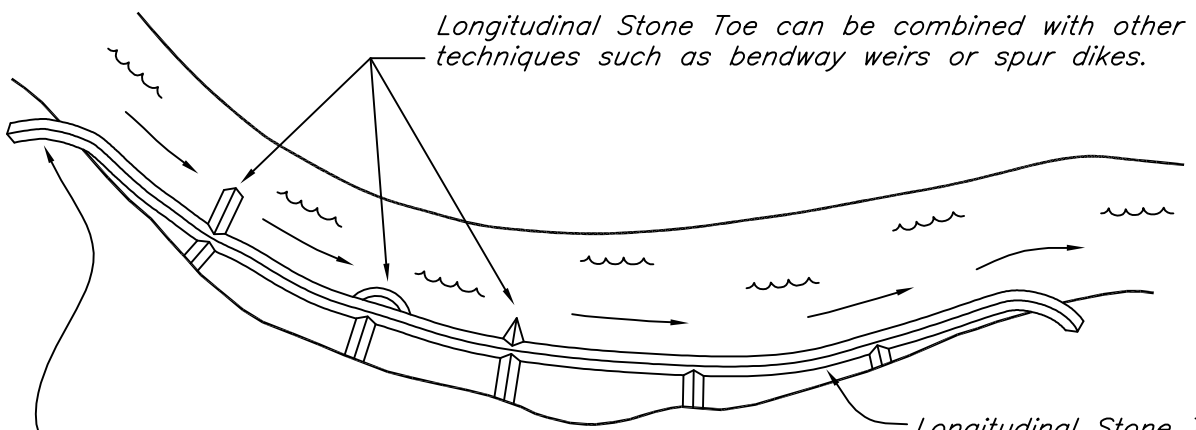

LPSTP must be 'keyed' deeply into the bank at both the upstream and downstream ends and at tiebacks spaced 1-2 times the channel width along the entire length.

"Smoothed" outer bank alignment results in improved (less erosive) flow near the toe.

TYPICAL LPSTP CONTINUOUS BANK PROTECTION

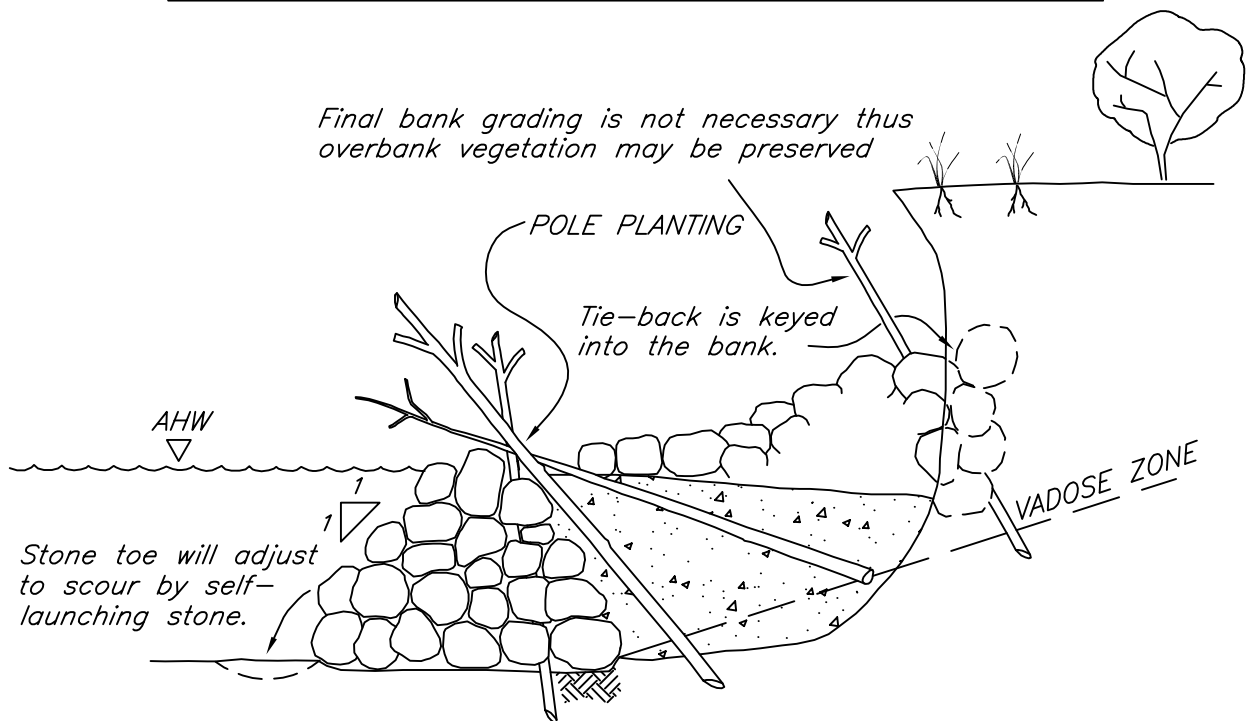

NOTES:

1. Longitudinal stone toe is a good choice when continuous bank protection is needed for the toe, but the mid and upper banks are relatively stable and/or biotechnical practices are suitable.
2. The success of Longitudinal Stone Toe depends on the ability of the well-graded stone to self adjust or "launch" into any scour holes formed on the stream side of the stone toe.

LONGITUDINAL STONE TOE

© 2000 JOHN McCULLAH

FILE: LPSTP

Description and Purpose

- Vegetated Mechanically Stabilized Earth (VMSE) technique consists of live cut branches (brushlayers) interspersed between lifts of soil wrapped in natural fabric, e.g., coir, or synthetic geotextiles or geogrids
- The live brush is placed in a criss-cross or overlapping pattern atop each wrapped soil lift in a manner similar to conventional brushlayering
- The fabric wrapping provides the primary reinforcement in a manner similar to that of conventional mechanically-stabilized earth
- The live, cut branches eventually root and leaf out, providing vegetative cover and secondary reinforcement as well
- In some cases, the vegetative treatment may consist of using a coarse netting for the soil wraps and establishing a herbaceous or grass cover by hydroseeding through the openings in the fabric
- VMSE can be viewed as a union between conventional, mechanically stabilized earth methods that utilize inert, tensile inclusions, and brushlayering, a soil bioengineering technique that utilizes live, cut branches as the tensile soil inclusions
- Fabric wraps provide the primary reinforcement and mechanical stabilization, permitting much steeper slopes to be constructed than would be possible with live brushlayers alone

Applications

- This technique provides an alternative to vertical retaining structures, e.g., timber pile walls, and to techniques that require slope flattening or bank lay back, which results in excessive right-of-way encroachment at the top of bank
- The use of synthetic geotextiles or geogrids provides greater long-term durability and security
- The fabric or geotextile wrap also provides additional protection to upper portions of streambanks that are subject to periodic scour or tractive stresses
- If either steady, long term seepage or temporary bank return flows after flood events are a problem, the brushlayers act as a drainage layer or conduits that relieve internal pore water pressure, and favourably modify the groundwater flow regime within the slope to minimize slope stability problems

Streambank Stabilization Techniques

Advantages

- The presence of vegetation mutes or softens the stark visual appearance of conventional mechanically stabilized earth structures and provides potential habitat for riparian wildlife
- Overhanging branches of the live brushlayers provide shade for fish and a substrate for insects and other organisms that the fish feed upon
- Branches also input leaves and twigs into the stream
- Since the inert fabric wraps or geosynthetic tensile inclusions provide reinforcement and mechanical stabilization, they permit much steeper slopes to be constructed than would be possible with live brushlayers alone
- Brushlayering treatment by itself is normally restricted to slopes no steeper than 1V:2H. VMSE can be constructed with a slope as steep as 1V:0.5H
- The vegetation shields the fabric against damaging UV radiation, and provides visual and riparian habitat benefits
- In addition, when live brushlayers are used, they provide secondary reinforcement, both from the stems themselves, and from rooting along their imbedded lengths
- The brushlayers act as horizontal drains that favourably modify the groundwater regime in the vicinity of the slope face, thereby improving stability against mass slope failure

Limitations

- A VMSE structure must be constructed during the dormancy period to insure good vegetative propagation and establishment
- Alternatively, the live cuttings may be harvested during dormancy, and placed in temporary cold storage until they are ready for use during an out-of-dormancy period, i.e., during the summer months (increases the cost)
- Materials procurement is more demanding, and installation more complex, because of the blending of two distinct methods, i.e., conventional MSE and live brushlayering, into a single approach
- Costs will also be more than brushlayering used alone, because of the added expense of the geotextile and the additional labour required to handle and construct the wraps
- VMSE streambank structures must be constructed during periods of low water because of the need to excavate and backfill a trench with rock in the streambed to provide a stable foundation

Construction

- A VMSE installation begins at the base of the slope and proceeds upwards
- The structure should be supported on a rock toe or base and be battered or inclined at an angle of at least 10 to 20° to minimize lateral earth forces
- The following guidelines and procedures apply:
 - Excavate a trench to a competent horizon below the likely depth of scour, and backfill it with rock to provide a base for the VMSE structure
 - The top surface of the rock should be inclined with the horizontal to establish the desired minimum batter angle for the overlying structure
 - Construct an earthen structure reinforced with either polymeric geogrids (or coir fabric) and live brush on top of the rock base
 - Place select fill material on the geogrid (or fabric) and compact it in 7.5 cm lifts to a nominal thickness ranging from 30 to 76 cm
 - Thinner lifts are used at the base of the structure, where shear stresses are higher
 - Temporary batter boards may be required at the front face to confine the select fill during the installation process and to form an even face
 - When geogrids are used, burlap strips at least 1.2 m wide can be inserted between the earthen fill and the geogrids at the front face to contain the fines and prevent initial ravelling of the fill through the apertures in the geogrid
 - The geogrid or fabric sheet should be allowed to drape down or protrude beyond the front edge of each underlying lift of earthen fill to create at least a 0.9 m overlap when it is pulled up and over the next lift
 - The exposed sections of geogrid or fabric layers are pulled up and over the faces of the fill layers and staked in place
 - The geogrids should be pulled as uniformly as possible before staking to develop initial tension in the geogrid or fabric. A tractor or winch pulling on a long bar with hooks or nails along its length works well for this purpose
 - The tensioned geogrid overlap sections should be secured in place using wood construction stakes spaced every 0.9 m
 - Layers of live cut branches are then placed criss-crossed atop the underlying wrapped soil lift
 - 25 to 50 mm of topsoil should be mixed in with the cut branches

- The top soil can be placed beforehand or spread over the top of a brushlayer
- Up to three layers of live, cut branches interspersed with 25 to 50 mm of topsoil can be placed in this manner
- The process is repeated with succeeding layers of earth fill, live brush and geogrids (or fabric) until the specified height or elevation is reached
- The recommended earthen lift thickness between geogrid (or fabric) layers depends on various soil and site variables, properties of the reinforcements, and desired safety factor
- The maximum vertical spacing and imbedded length of successive geogrid or reinforcement layers are determined from the specified safety factor, slope angle, soil shear strength, allowable unit tensile strength, and interface friction properties of the reinforcement layer

Construction Considerations (Materials and Equipment)

- The technique can also be used in conjunction with other techniques, particularly resistive techniques, designed primarily to protect the bank toe (Vegetated Riprap and Rootwad Revetments) and redirective techniques (Bendway Weirs, Spur Dikes, and Vanes)
- If excessive seepage daylights from or exits the bank, then a vertical drainage course can be interposed between the bank and the VMSE structure
- Select long branches of native tree species that are capable of vegetative propagation. Willows are the most commonly used plant material, because they generally root well from cuttings.
- Alder, cottonwood (*Populus deltoides*), and dogwood (*Cornus*) can also be used effectively, particularly when mixed in with willow
- The length of the branches will vary depending upon the desired depth of reinforcement, but they should be long enough to reach the back of an earthen buttress placed against a streambank while protruding slightly beyond the face
- The diameter of the live cuttings will also vary depending on their length, but typically should range from 19 to 51 mm at their basal ends.

Vegetated Mechanical Stabilized Earth (VMSE)

B.M.P. #44

Streambank Stabilization Techniques

Inspection and Maintenance

- Inspection frequency should be in accordance with the PESC and TESC Plans
- There are no compelling maintenance requirements in the case of VMSE installed along a streambank
- The vegetation should establish successfully without irrigation requirements given the proximity to water
- Monitoring should consist of inspecting the geogrids (or fabric) for signs of breakage or tearing from scour damage or possibly from excessive tensile stresses due to higher than expected lateral earth pressures
- Signs of uncontrolled seepage, such as weeping or wet spots in the structure, should also be noted
- The site should be examined for possible signs of flanking erosion, which must be addressed with ancillary protective measures lest the flanking threaten the integrity and effectiveness of the VMSE structure itself
- Common modes of failure:
 - Inadequate primary reinforcement from the inert tensile inclusions (fabric or geotextile), i.e., improper vertical spacing or lift thickness, insufficient allowable unit tensile resistance in the selected fabric or geotextile, too short an embedment length, etc., for the given soil and site conditions, i.e., slope height, slope angle, and soil shear strength properties
 - Failure to properly consider seepage conditions and install adequate drainage measures, e.g., chimney drain behind VMSE structure
 - Inadequate attention to construction procedures and details

Design Considerations

- It is critical that factors such as scour depth be determined for each particular project and be incorporated into project design
- Many different types of inclusions with various shapes and properties can be used to reinforce and buttress earthen slopes. These inclusions range from imbedded metal strips, geogrids fabricated from polymeric nets, and natural or synthetic geotextiles or fabrics
- Shear stresses that develop in the soil matrix are transferred into tensile resistance in the imbedded inclusions via friction along the soil-inclusion interface

Vegetated Mechanical Stabilized Earth (VMSE)

B.M.P. #44

Streambank Stabilization Techniques

- Mechanically stabilized earth retaining structures must satisfy external stability requirements, i.e., have adequate resistance to sliding, overturning, and bearing capacity failure
- The tensile inclusions or reinforcements in these structures must have a sufficient unit tensile resistance and/or be placed in sufficient numbers to resist breaking in tension
- The inclusions must also be sufficiently long and "frictional" enough to resist failure by pullout
- Synthetic geogrids fabricated from high-tensile strength polymeric materials are widely used in reinforced earth embankments and retaining walls. Geogrids tend to have superior pullout resistance compared to geotextile or fabric sheets. They can be used either in a wrap-around fashion to provide both backfill reinforcement and containment at the front face
- Live cuttings act as tensile inclusions and help to stabilize a slope, embankment, or structural fill
- The main considerations in the design of geogrid or geotextile reinforced earthen slopes and embankment fills is the required vertical spacing (d) and total length (L) of the reinforcing layers
- The total length (L) is comprised of a length or distance required to reach the expected failure surface in the backfill and an additional length, the effective or imbedment length (L_E), extending beyond the failure surface required to prevent pullout
- The reader should consult with a geotechnical engineer

STEP 1.

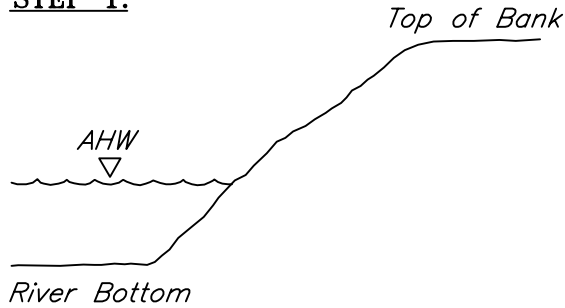

STEP 5.

Wrap second layer of soil/gravel with fabric.

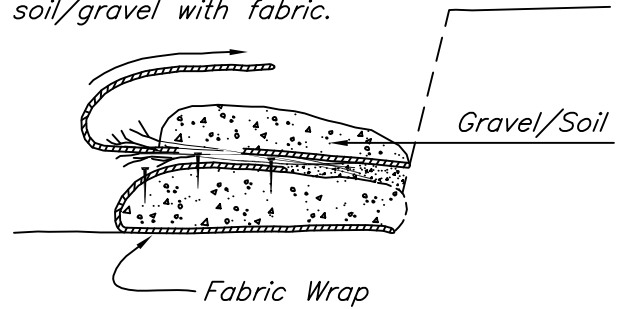

STEP 2.

Construct during periods of low water or isolate work area.

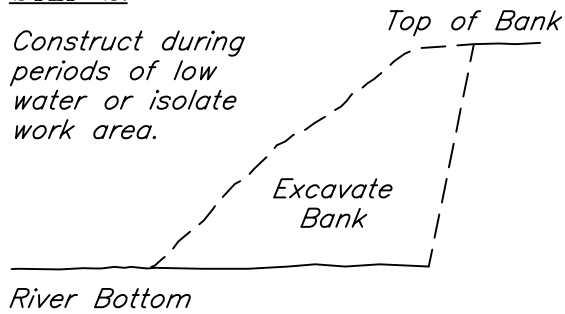

STEP 6.

Repeat steps 3, 4, 5 until desired height of bank is reached.

STEP 3.

Wrap soil with fabric.

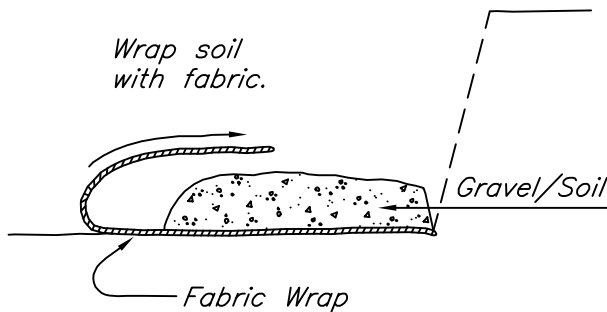

Revegetate with native plants.

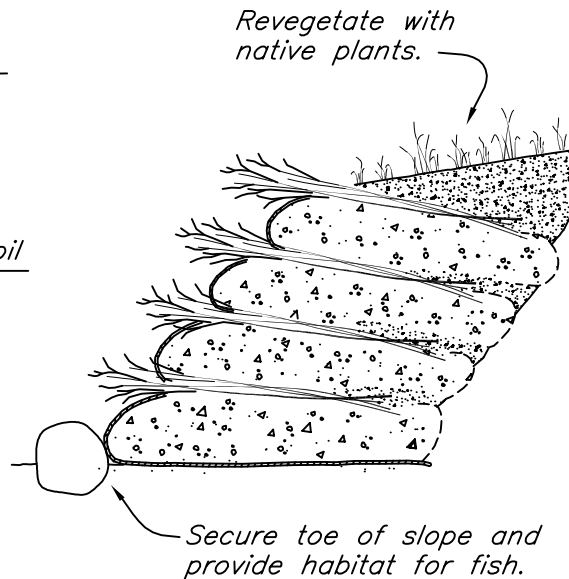

STEP 4.

Crisscross layers of dormant cuttings and/or transplants.

Deposit layer of top soil over cuttings.

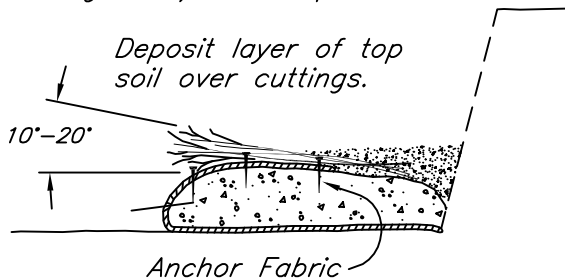

VEGETATED MECHANICALLY STABILIZED EARTH STEP BY STEP

© 1999 JOHN McCULLAH

FILE: LAYERSXS

Description and Purpose

- Vegetative Rip-Rap combines the widely-accepted, resistive, and continuous rock revetment techniques with vegetative techniques. It consists of a layer of stone and/or boulder armouring that is vegetated, optimally during construction, using pole planting, brushlayering and live staking techniques
- Continuous and resistive bank protection measures, such as riprap and longitudinal rock toes are primarily used to armour outer bends or areas with impinging flows
- The stream energy is resisted by the continuous protection, and is subsequently directed downward into the streambed
- The riprap will resist the hydraulic forces, while roots and branches increase geotechnical stability, prevent soil loss (or piping) from behind the structures, and increase pull-out resistance
- The roots, stems, and shoots will help anchor the rocks and resist 'plucking' and gouging by ice and debris

Applications

- Vegetated Rip-Rap is appropriate where infrastructure is at risk, and where redirective and discontinuous bank protection measures have been rejected or deemed inappropriate
- Vegetative Rip-Rap techniques are sometimes considered mitigation for some of the impacts caused by riprap
- Incorporating large and dense trees may be beneficial where thermal pollution is occurring, along north-facing banks (trees will cast shade) and where cover is necessary to protect fish (rearing habitat)

Advantages

- Correctly designed and installed, Vegetated Rip-Rap offers an opportunity for the designer to attain the immediate and long-term protection afforded by riprap with the habitat benefits inherent with the establishment of a healthy riparian buffer
- Above ground components of the plants will create habitat for both aquatic and terrestrial wildlife, provide shade (reducing thermal pollution), and improve aesthetic and recreational opportunities
- When graded or "self-launching" stone is used, riprap is self-adjusting to small amounts of substrate consolidation or movement
- The revetment can sustain minor damage and still continue to function adequately without further damage

- The rough surface of the riprap dissipates local currents and minimizes wave action more than a smooth revetment (like concrete blocks)
- Stones are readily available in most locations, and materials are less expensive than many other "hard armouring" techniques
- The rock provides a large amount of aquatic habitat
- Rip-Rap is easily repaired by placing more rock where needed
- The fibrous roots of the chosen vegetation prevents washout of fines, stabilizes the native soil, anchors armour stone to the bank, and increases the lift-off resistance
- The vegetation also improves drainage of the slope by removing soil moisture for its own use
- Vegetated Rip-Rap has a more natural appearance, and is therefore more aesthetically pleasing, which is frequently a matter of great importance in high-visibility areas
- In addition, environmental clearances are frequently easier to obtain if the project has biotechnical and habitat enhancement benefits incorporated into the design
- There are many environmental benefits offered by Vegetated Rip-Rap, most of which are derived from the planting of willows or other woody species in the installation
- The willow provides canopy cover to the stream, which gives fish and other aquatic fauna cool places to hide
- The vegetation also supplies the river with carbon-based debris, which is integral to many aquatic food webs, and birds that catch fish or aquatic insects will be attracted by the increased perching space next to the stream
- An additional environmental benefit is due to the use of rock, as the surface area of the rocks is substrate that is available for colonization by invertebrates
- The small spaces between the rocks also provide benthic habitat and hiding places for small fish and fry
- The brushlayering methods reach out over the water, and provide shade and organic debris to the aquatic system

Limitations

- Vegetated Rip-Rap may be inappropriate if flow capacity is an issue, as bank vegetation can reduce flow capacity, especially when in full leaf along a narrow channel
- In remote areas large rocks may be difficult to obtain and transport, which may greatly increase costs

- Riprap may present a barrier to animals trying to access the stream

Construction

The vegetation obtained should be poles of adventitiously-rooting native species (such as willow, cottonwood or dogwood), with a minimum diameter of 38 mm, and be sufficiently long to extend into the vadose zone below the riprap.

Vegetated Rip-Rap with Willow Bundles

- Grade the bank to the desired slope where the riprap will be placed, such that there is a smooth base
- Dig a toe trench for the keyway (if required) below where the riprap will be placed
- Place 10 to 15 cm (5 to 8 stem) bundles on the slope, with the butt ends placed at least 30 cm in the low water table
- This will probably involve placing the poles in the toe trench before the rock is placed, if standard riprap rock is being used
- Digging shallow trenches for the willows prior to placing them on the slope will decrease damage to the cuttings from the rocks, and may increase rooting success because more of the cuttings will be in contact with soil
- The bundles should be placed every 1.8 m along the bank, and be pointed straight up the slope
- Once the bundles are in position, place the rock on top of it to the top of the slope
- The bundles should extend 0.3 m above the top of the rock
- If the bundles are not sufficiently long, they will probably show decreased sprouting success, and therefore, a different technique should be chosen

Vegetated Rip-Rap with Bent Poles

- Grade back the slope where the riprap will be placed, such that there is a smooth base
- Dig a toe trench for the keyway (if required) below where the riprap will be placed
- If non-woven geotextile is being used, lay the fabric down on the slope, all the way into the toe trench, and cut holes in the fabric about 0.6 to 0.9 m above the annual low water level
- Slip the butt ends of the willow poles through the fabric and slide them down until the bases are at least 15 cm into the perennial water table, or at the bottom of the toe trench, whichever is deepest

- If using filter gravel, lay it down on the slope, and place a layer of willow poles on top of the gravel, with the bases of the cuttings at least 15 cm into the perennial water table, or at the bottom of the toe trench, whichever is deepest
- Place the largest rocks in the toe trench
- Ensure that they lock together tightly, as they are the foundation for the structure
- Place the next layer of boulders such that it tapers back slightly toward the streambank
- Bend several willow poles up, such that they are perpendicular to the slope, and tight against the first layer of rocks
- Now place the next layer of rocks behind these poles
- Placement will require an excavator with a thumb, as someone will have to hold the poles while the rocks are placed
- As the poles are released, they should be trimmed to 30 cm above the riprap
- This last step should be repeated until all the poles have been pulled up, and the entire slope has been covered

Vegetated Rip-Rap with Brushlayering and Pole Planting

There are two methods of constructing brushlayered riprap; one involves building up a slope, and the other works with a pre-graded slope – neither method can be used with non-woven geotextile

Method 1 (building up a slope):

- Lay the bank slope back to somewhat less than the desired finished slope
- Dig a toe trench, if needed, and lay the key rocks into the trench. Pack soil behind these rocks, with filter gravel in between the soil and rocks
- Continue installing riprap 0.9 to 1.2 m up the bank
- Slope the soil back into the bank at a 45° angle, such that the bottom of the soil slope is in the vadose zone
- Place a layer of willow cuttings on top of the soil, with the butt ends extending into the vadose zone, and the tips of the branches sticking out 30 to 60 cm
- Place the next layer of stones on top of the initial rocks, but graded slightly back, and repeat the soil and brush layering process
- When finished, trim the ends of the willow branches back to 30 cm
- Do not cut shorter than 30 cm, as the plant will have difficulty sprouting

Method 2 (pre-graded slope):

- Lay the bank slope back to the desired finished grade, and dig a toe trench if self-launching stone is not being used
- Place the largest rocks in the key-way, and fill in behind with filter gravel and soil
- Continue installing riprap 0.9 to 1.2 m up the bank
- Place the bucket of an excavator just above the layer of rocks at a 45° angle
- Pull the bucket down, still at a 45° angle, until the water table is reached, or the stream is dry, to the elevation at the bottom of the key trench
- Pull up and back on the bucket; this will provide a slot in the bank into which willow poles can be placed
- Throw in some willow poles (about 18 poles per linear m), ensuring that the butt ends are at the bottom of the trench
- Release the scoop of earth, and allow it to fall back in place on the slope
- Then place the next layer of rock on top of the branches, flush with the slope
- If self-filtering stone is not being used, filter gravel should be placed behind the rocks
- Repeat the process, beginning again with pulling back a scoop of soil
- Continue this process to the top of the slope, or if preferred, use joint-planted riprap on the upper slope, where it is difficult to reach the perennial water table with the excavator bucket
- When finished, trim the ends of the branches back such that only 30 cm extends beyond the revetment

Construction Considerations

- The technique can also be used in conjunction with other techniques, particularly resistive techniques, designed primarily to protect the bank toe (Vegetated Rip-Rap and Rootwad Revetments) and redirective techniques (Bendway Weirs, Spur Dikes, and Vanes)
- While riprap is very effective at arresting bank erosion and providing relatively permanent bank protection the environmental consequences can be less than desirable and should, therefore always be taken into account when selecting an environmentally-sensitive streambank stabilization treatment
- Scour counter-measures are sometimes required for continuous and resistive rock bank protection
- One alternative is a rock-filled key trench, designed with appropriate scour analysis

- Another counter-measure that may be employed is the use of graded, self-launching stone

Filter Material:

- Some sort of filter material is typically used to prevent piping of fine soils from below the riprap, if self-launching stone is not used
- There are two choices: non-woven geotextile fabric or graded filter gravel
- Non-woven geotextile fabrics are not recommended for use in Vegetated Rip-Rap, as roots have difficulty penetrating the fabric
- If non-woven geotextile fabric is required, one can cut holes in the fabric where the vegetation is placed
- Small slits in the fabric are especially appropriate with the bent pole method
- Filter gravel is the preferred filter media for Vegetated Rip-Rap

Rock Size:

- There are two options for rocks – self-launching/self-filtering rock or standard riprap
- The advantage of self-launching/self-filtering rock is that the revetment will build its own toe, by self-launching, in any scour hole that forms
- The different sizes of rock act as their own filter medium, so no geotextile fabric or filter gravel is needed
- This decreases cost, and also makes installation less labour-intensive for two of the three methods of installation
- Using self-launching stone is dependent on a source of graded rock, which is not always available

Inspection and Maintenance

- Riprap should be visually inspected as frequently as outlined in the PESC and TESC Plans, with focus on potential weak points, such as transitions between undisturbed and treated areas
- Soil above and behind riprap may show collapse or sinking, or loss of rock may be observed
- Inspect riprap during low flows annually, to ensure continued stability of the toe of the structure
- Treat bank or replace rock as necessary

Design Considerations

- It often takes many years for riprap to become vegetated if vegetation is not integrated into its design and construction at the outset
- Flanking, overtopping or undermining of the revetment due to improperly installed or insufficient keyways is one of the biggest reasons for failure of riprap
- Improperly designed or installed filter material can also cause undermining and failure of the installation
- Undersized stones can be carried away by strong currents, and sections of the revetment may settle due to poorly consolidated substrate
- Vegetation may require irrigation if planted in a nondormant state, or in extremely droughty soils

Vegetated Rip-Rap with Willow Bundles

Is the simplest to install, but it has a few drawbacks:

- This technique typically requires very long (3 to 7m) poles and branches, as the cuttings should reach from 15 cm below the low water table to 30 cm above the top of the rock
- Only those cuttings that are in contact with the soil will take root, and therefore, the geotechnical benefits of the roots from those cuttings on the top of the bundle may not be realized

Vegetated Rip-Rap with Bent Poles

- Is slightly more complex to install
- A variety of different lengths of willow cuttings can be used, because they will protrude from the rock at different elevations
- The angle can be three to one, or forty-five degrees
- A tree and root growth will develop the entire length of each pole planted

Vegetated Rip-Rap with Brushlayering and Pole Planting

- Is the most complex type of riprap to install, but also provides the most immediate habitat benefits
- The installation of this technique is separated into 2 methods; one method describes installation when building a bank back up, while the other is for a well-established bank
- If immediate aquatic habitat benefits are desired, this technique should be used
- May not provide the greatest amount of root reinforcement, as the stem-contact with soil does not extend up the entire slope

NOTES:

1. Install willow pole planting and brushlayering during bank grading and riprap placement to ensure good contact with 'native ground' and/or soil fill.
2. Willow poles and brush layers shall extend down into expected soil moisture zones (vadose).
3. Cut small holes or slits in geotextile fabric as necessary.
4. Place soil fill (cobbles, gravel, soil) around cuttings.
5. Place riprap carefully, do not end dump. Some damage to brush layers and willow poles is unavoidable and acceptable. Deeply planted willow material will regenerate.

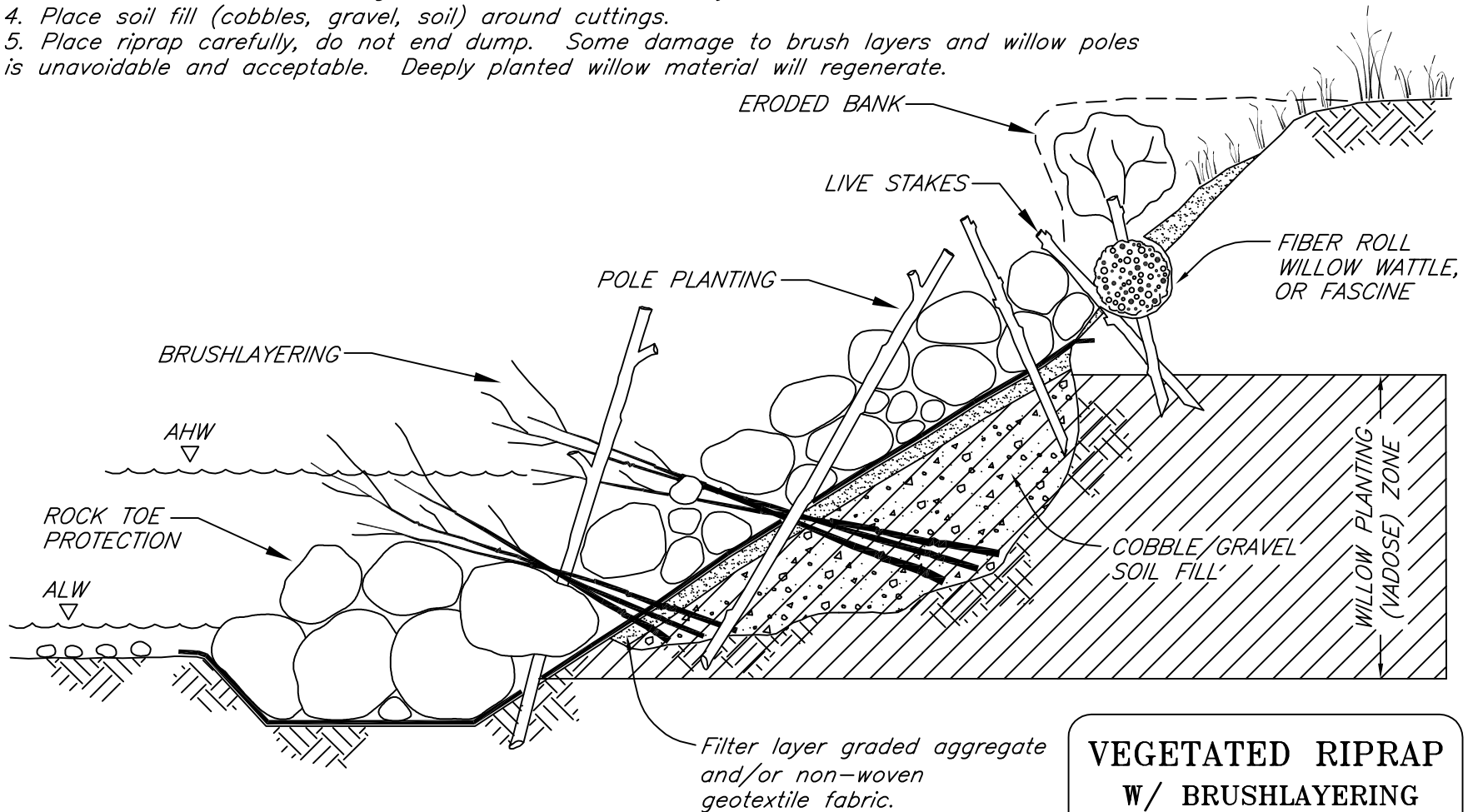

**VEGETATED RIPRAP
W/ BRUSHLAYERING
& POLE PLANTING**

© 1999 JOHN McCULLAH

VGRIPRAP

NOTES:

1. As a general rule, place basal ends of the cuttings 15 cm into the capillary fringe or seasonal saturated zone.
2. Bend individual poles up through the riprap during placement while ensuring contact of the stem with native ground. Laying poles 'horizontally' is an efficient and cost-effective way to maximize rooting.
3. Graded, granular filter is preferable to geotextile fabric to improve root penetration or slip poles through slits cut into fabric.
4. Place soil fill (cobbles, gravel, soil) around cuttings and 'water in' if possible.

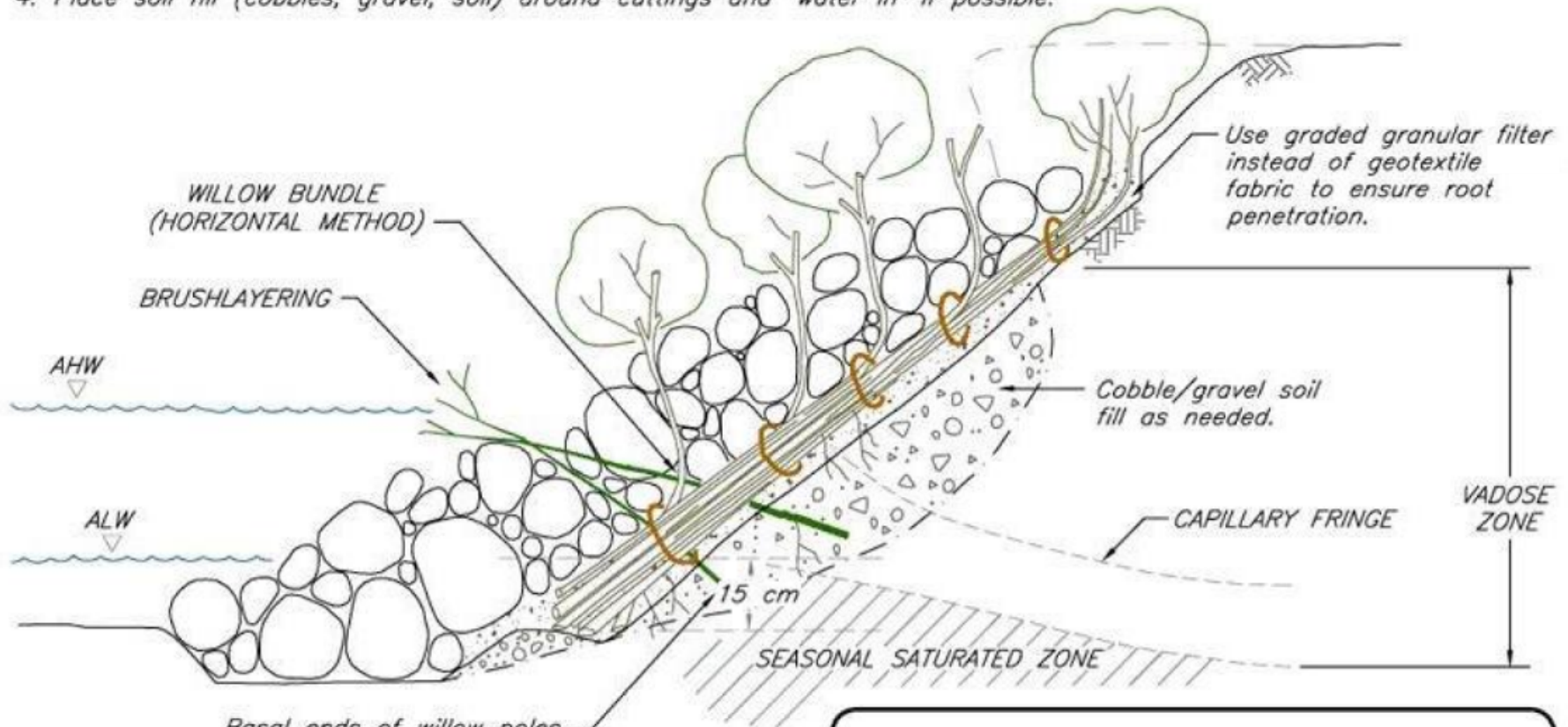

VEGETATED RIPRAP
WILLOW BUNDLE METHOD (HORIZONTAL)

© 2004 SALIX

FILE: VRBND

NOTES:

1. Integrate brushlayering, pole planting and live siltation techniques during rock placement to ensure contact with native ground. Laying poles 'horizontally' is an efficient and cost-effective way to maximize rooting.
2. As a general rule, place basal ends of the cuttings 15 cm into the capillary fringe or seasonal saturated zone.
3. Graded, granular filter is preferable to geotextile fabric to improve root penetration or slip poles through slits cut into fabric.
4. Place soil fill (cobbles, gravel, soil) around cuttings and 'water in' if possible.

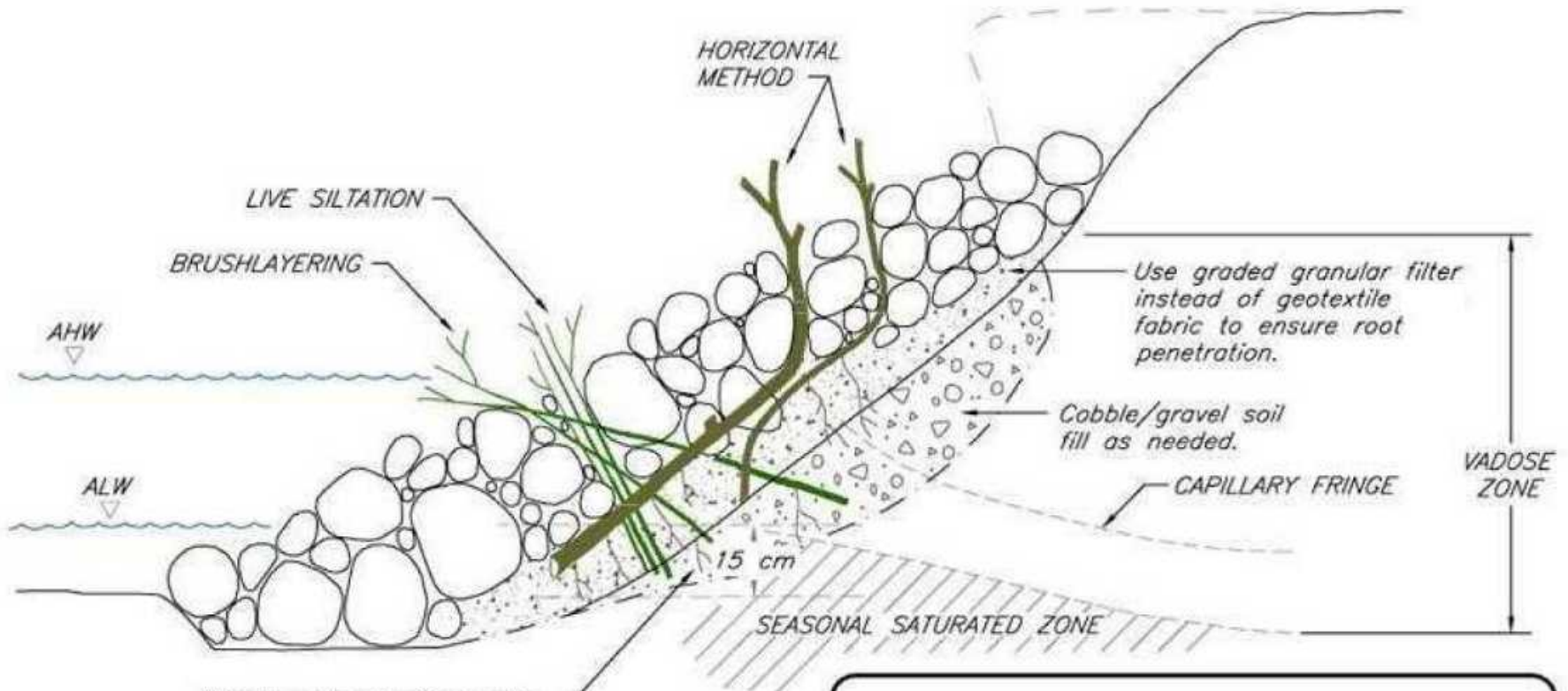

**VEGETATED RIPRAP
BENT POLE METHOD (HORIZONTAL)**

© 2004 SALIX
FILE: VRBP

NOTES:

1. Integrate brushlayering, pole planting and live siltation techniques during rock placement to ensure contact with native ground.
2. Plant deeply if possible. Place cuttings deeply into vadose zone, into the capillary fringe or 15 cm into the seasonal saturated zone (water table).
3. Graded, granular filter is preferable to geotextile fabric to improve root penetration or slip poles through slits cut into fabric.
4. Place soil fill (cobbles, gravel, soil) around cuttings and 'water in' if possible.
5. Place riprap carefully, do not end dump. Some damage to brush layers and willow poles is unavoidable and acceptable. Deeply planted willow material will regenerate.

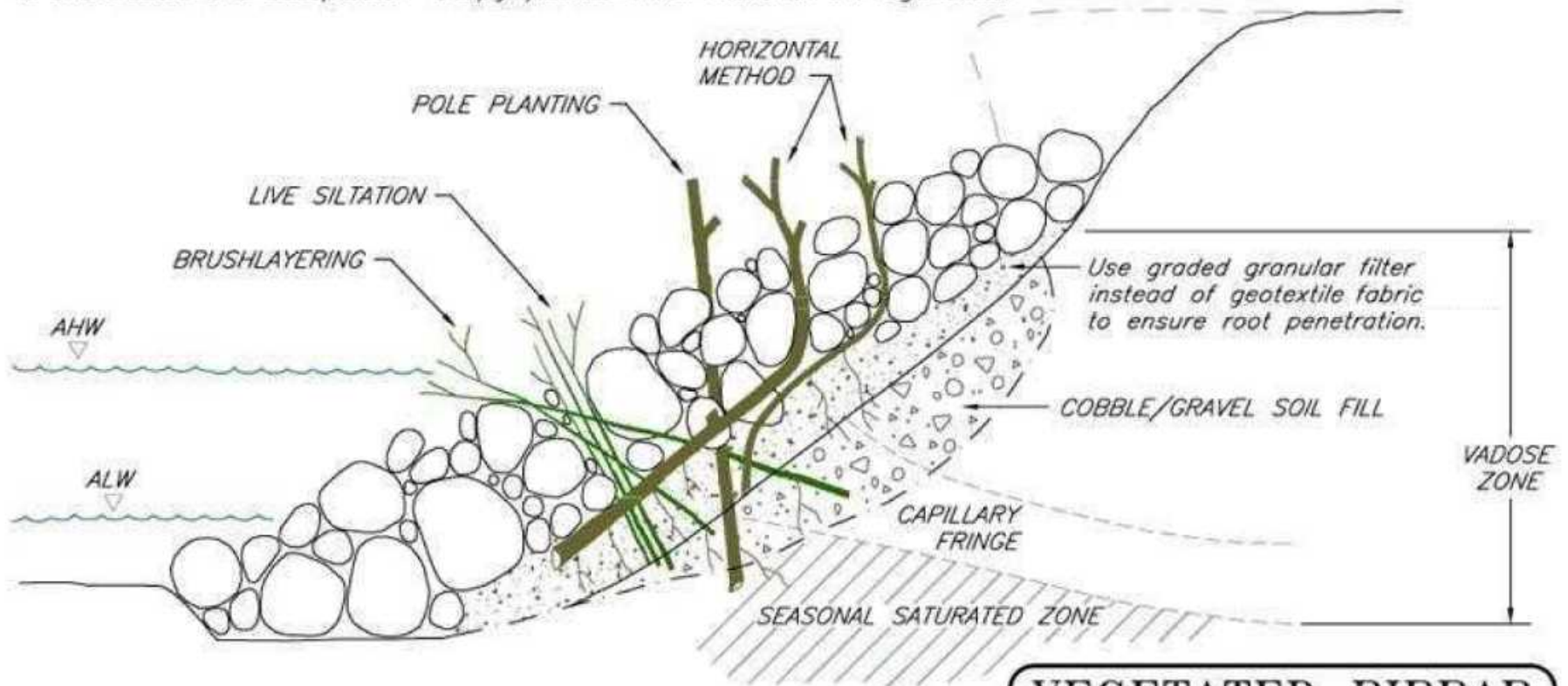

**VEGETATED RIPRAP
DURING CONSTRUCTION
SUMMARY OF TECHNIQUES**

© 2004 SALIX

FILE: VRDC

APPENDIX D

- **INSPECTION AND MAINTENANCE FORM**
- **CHECKLIST FOR EROSION AND SEDIMENT CONTROL PLAN DEVELOPMENT**

THIS PAGE LEFT BLANK INTENTIONALLY.

INSPECTION AND MAINTENANCE FORM

AT Contract Number: _____
 Construction Site Location: _____
 Heavy Equipment on Site: _____
 Date: _____ mm of rain in last week: _____
 Date of Last Inspection: _____ mm of rain in last 24 hours: _____

Contractors on Site: _____
 Construction Activities on Site: _____
 Current Weather: _____
 Weather Forecast: _____

| Type of Measure (BMP) | Location on Construction Site | Intended Function | Sediment Levels | General Condition | General Performance | Maintenance Required | Type of Maintenance Required | Site Manager Notified | Date Repairs to be Completed By |
|-----------------------|-------------------------------|-------------------|---|-------------------|---------------------|----------------------|------------------------------|-----------------------|---------------------------------|
| | | | 0 – 1/4 - 1/2 – 3/4 Full not applicable | poor fair good | poor fair good | yes no | | yes no | |
| | | | 0 – 1/4 - 1/2 – 3/4 Full not applicable | poor fair good | poor fair good | yes no | | yes no | |
| | | | 0 – 1/4 - 1/2 – 3/4 Full not applicable | poor fair good | poor fair good | yes no | | yes no | |
| | | | 0 – 1/4 - 1/2 – 3/4 Full not applicable | poor fair good | poor fair good | yes no | | yes no | |
| | | | 0 – 1/4 - 1/2 – 3/4 Full not applicable | poor fair good | poor fair good | yes no | | yes no | |
| | | | 0 – 1/4 - 1/2 – 3/4 Full not applicable | poor fair good | poor fair good | yes no | | yes no | |
| | | | 0 – 1/4 - 1/2 – 3/4 Full not applicable | poor fair good | poor fair good | yes no | | yes no | |
| | | | 0 – 1/4 - 1/2 – 3/4 Full not applicable | poor fair good | poor fair good | yes no | | yes no | |

Notes:

Inspectors Name: _____

Inspectors Signature: _____

Copies to: AT Designated Inspector: _____ Contractors Site Designate: _____ ESC Plan Designer: _____

THIS PAGE INTENTIONALLY LEFT BLANK

CHECKLIST FOR EROSION AND SEDIMENT CONTROL (ESC) PLAN DEVELOPMENT

The following checklist may be used to ensure that Erosion and Sediment Control Plans follow the method and structure outlined in the Guide. For small, low-risk roadway construction projects that only require the application of procedural BMPs, it may not be necessary to undertake detailed BMP design. Refer to Section 8 for guidance regarding the appropriate level of effort to be applied.

DATA COLLECTION

- Identify and initiate contact with other members of the ESC team:
 - Owner or owner's representative
 - Project designer
 - Contractor and site inspector (if selected)
- Identify and initiate contact with applicable regulatory agencies (establish information needs)
- Compile relevant site information as applicable:
 - Construction drawings, design data and construction schedule
 - Geotechnical investigation reports
 - Aerial photography/imagery
 - Surficial geology maps
 - Vegetative cover maps
- Site inspection by ESC Plan Designer:
 - Photographs to document existing site conditions
 - Regulatory requirements
 - Fisheries assessments

Site Erosion Potential and Evaluation

- Assess the site-specific erosion potential
- Assess the risk of erosion due to roadway construction activities
- Determine appropriate level of effort, performance goals and evaluation measures

Erosion and Sediment Control Plan Design

- Develop an erosion and sediment control plan that is effective and coordinated with construction activities
- Define the areas of concern for the project
- Divert upstream water around the construction site (where applicable)
- Evaluate the construction site drainage:

- Define drainage areas within the construction site
- Define drainage patterns within each drainage area
- Determine drainage channel alignments
- Determine channel tributary areas and drainage channel characteristics
- Based on drainage characteristics, specify Best Management Practices (BMPs)
 - Incorporate procedural BMPs
 - Promote good housekeeping measures to reduce the amount of erosion during construction
 - Consider minimizing exposed soils, using existing drainage pathways, reducing runoff from stockpiles, and installing signage around sensitive areas
 - Consider working during relatively dry conditions, installing erosion and sediment control measures early, and revegetating exposed soils early
 - Incorporate appropriate erosion control BMPs
 - Prevent erosion at its source
 - Consider factors such as flow, soil characteristics, topography, climate, season, permanence, accessibility and cost when choosing erosion control measures
- Consider factors such as flow, soil characteristics, topography, climate, season, permanence, accessibility and cost when choosing sediment control measures

Report Requirements

- Provide a project description
- Describe erosion and sediment control objectives
- Document existing site conditions
- Identify critical areas of concern
- Include a section on erosion and sediment control accountability and administration
 - Provide a list of emergency and non-emergency contacts
- Describe BMPs to be used
 - Include details on installation locations and alignments
 - Include an inspection and maintenance plan for all BMPs
- Provide a series of construction drawings illustrating and describing mitigation measures to be undertaken during all phases of the project

APPENDIX E

**ESTIMATING RUNOFF FROM SMALL
WATERSHEDS**

THIS PAGE LEFT BLANK INTENTIONALLY.

TABLES

- Table E.1 Return Frequencies for Roadway Drainage Design
Table E.2 Rational Method Values

E.1 Introduction

Drainage areas along rural highways are typically small (less than 20 ha) and can have long flow lengths. Rural highway catchments have relatively low imperviousness levels that generate lower runoff rates than similarly sized urban catchments. Runoff does, however, become concentrated along ditches and near outlet points, thus increasing erosion potential. Estimating peak runoff flow rate from small watersheds on a highway construction site is a key activity in the design of suitable erosion and sedimentation control measures. Using estimates of peak runoff flows, channels and control structures can be adequately sized to prevent overtopping and washout.

This chapter focuses on runoff calculation methods for highway construction sites in rural conditions. The estimation of runoff for urban highway construction sites is complicated by the effects of urbanization and development. As such, urban runoff flow rate estimation methods are not presented in this document. Reference should be made to Design Bulletin #16 for information relating to drainage for Provincial Highways in urban areas (www.transportation.alberta.ca/649.htm).

The objective of utilizing flow estimates is to provide a stable and economical erosion protection design. It is of paramount importance that the erosion and sedimentation control strategy withstand the design runoff flow rates during its lifespan. Generally, it is usually most cost-effective to utilize the existing drainage pattern as much as possible. In terms of design frequency, different road types have specific purposes and require different design standards. Table E.1 summarizes the general design levels for runoff capacity for several road service levels.

Table E.1: Return Frequencies for Roadway Drainage Design

| Road Classification (RTAC 1976) | Return Period or Other Criteria for Storm Drainage System | | |
|------------------------------------|---|--------------|-----------------|
| | Minor System | Major System | Stream Channels |
| Freeway urban arterial | 10 year | 100 Year | 10 year |
| Rural arterial collector | 2 to 5 year | 100 Year | 2 to 5 year |
| Local | 2 year | 100 Year | 2 year |
| Depressed roadways | 10 to 25 year | | |

Notes:

1. The flood frequencies for storm drainage systems may be modified to reflect local municipal requirements and adjacent land uses.
2. The minor system comprises the road gutters, inlets, storm sewers, and minor ditches. The major system is the route followed by runoff waters when the capacity of the minor system is exceeded and generally includes the roadway surface itself and major channels.

The amount of time involved in carrying out an economic analysis often cannot be justified when implementing small temporary or permanent erosion and sedimentation control measures. Guidelines are thus established by various jurisdictions for the choice of an appropriate event to be used in design based on experience. Erosion control work of a permanent nature should thus be designed for a runoff event that corresponds to a return period of at least once in 10 years (a 1:10 year event). Furthermore, provision should be made for safe overflow or bypass in more extreme events. Temporary erosion control work may be designed for a runoff event that corresponds to a return period of at least twice in 5 years (a 2:5 year event).

Permanent vegetative or bio-engineered measures that will replace any temporary measures should be capable of withstanding at least a 1:10 year runoff event.

Economic analyses are appropriate for large temporary or permanent structures. Costs associated with various structure sizes are estimated and are compared with the benefits to be derived, including the benefit of having a reduced probability of failure and reduced maintenance effort. The frequency of the event chosen for design is then based on an optimization of investment expenditure. However, major roadways required for emergency purposes will always be designed to withstand runoff events of 1:100 years. Therefore, erosion protection measures for these roadways should have a similar standard.

Designs should be based on professional judgement and should be performed by a qualified professional.

E.2 Approaches to Runoff Estimation

There are several different approaches to estimating peak runoff flow. The main categories for estimating peak runoff flow are listed as follows:

- Rational Method;
- Flood frequency analysis;
- Hydrologic modeling; and
- Empirical formulae.

Of these methods, only the Rational Method will be discussed in this document. The Rational Method provides reasonable peak runoff flow estimates for small watersheds. The use of this procedure assumes that precipitation events of a given frequency produce runoff events of similar frequency.

The individual or firm responsible for designing erosion and sedimentation control measures must use their judgement and experience in determining the most appropriate means for estimating runoff flow rates.

E.2.1 Rational Method

The Rational Method is widely practiced in determining peak runoff flows for small to moderately sized catchments and can be applied to rural basins up to 25 km² (MTO 1984). However, it is considered to be most applicable to basin sizes under 100 ha where storage and channel routing effects are small. It is understood that there is no specific design manual for use of the Rational Method in Alberta, but there are complete reference documents in several other Provinces and from the United States. Caution should be exercised where lake storage and attenuation effects are significant within a basin. This does not generally apply to roadway areas where grading is continuous. The procedure is simple and relies on a minimal amount of local data. The formulation for the Rational Method is presented as follows:

$$Q = 0.00278 C \times I \times A \quad (\text{Equation E.1})$$

Where: Q = peak flow (m³/s)
C = runoff coefficient (dimensionless)
I = precipitation intensity (mm/hr)
A = effective drainage area (ha)

The simplicity of the equation has resulted in the method gaining widespread usage for more than 100 years. However, such simplicity was achieved by lumping the effects of a number of variables, namely soil conditions, surface cover, antecedent moisture, depression storage and land slope into a single input parameter referred to as the runoff coefficient. Extreme care should therefore be taken in the choice of the coefficient if reasonable accuracy is to be obtained. The Rational Method has been determined through comparisons, to typically overestimate flows so it is suitable for the design of erosion and sedimentation control measures. It is not applicable for bridge file designs.

The major limitation of the Rational Method is the output. While some other methods produce a runoff-time curve or hydrograph, the Rational Method produces only an estimate of the peak runoff. For erosion control works along roadways, this limitation is not significant, as all designs are done taking into consideration the peak discharge from an event having a particular design frequency. However, for larger sediment control structures, the peak inflow into the sediment basin may be modified by the storage effect of the reservoir resulting in a peak outflow that will be smaller than the inflow. In such a case, routing the inflow hydrograph through the basin will produce an outflow hydrograph that will be more appropriate for design. Routing procedures are not simple and should be performed by a qualified engineer.

E.2.1.1 Key Assumptions

Inherent in the use of the Rational Method are a number of key assumptions. Understanding these assumptions will lead to a better appreciation of the results provided by this method. These assumptions are presented as follows:

1. The rainfall intensity is uniform over the catchment for the duration of the storm. Rainfall events actually vary in both space and time. With very small catchments, the assumption may be true, but for larger catchments there will be a spatial variation in rainfall intensity and hence a tendency to overestimate runoff.
2. Maximum runoff occurs when rainfall lasts as long as or longer than the time of concentration (t_c). The t_c is the time for runoff to travel from the hydrologically most distant point in the watershed to the outlet or point of interest. The assumption is that every point within the catchment is contributing to runoff to the point under consideration. Again with small catchments, the assumption is likely to be true, but with larger catchments, there may be a divergence from the assumption due to channel routing and storage effects.
3. The design precipitation event has the same frequency as the runoff event being estimated. This is not necessarily true, as identical storm events can produce highly variable runoff hydrographs over the same catchment when conditions such as antecedent moisture, are different.

4. The effective drainage area should be used and it includes all areas that contribute runoff during major runoff events. Some areas of the province are internally draining sloughs and only evaporate or infiltrate runoff. These areas do not contribute runoff flows to the basin outlet.

E.2.1.2 Runoff Coefficient

Table E.2 provides guidelines for evaluating the value of the runoff coefficient, C . In areas having more than one soil type or land use, the effective coefficient is obtained by evaluating a coefficient for each sub-area and computing a "weighted" average for the entire catchment based on area served.

E.2.1.3 Rainfall Intensity

Statistical information relating to the intensity, duration, and frequency of rainfall events is currently collected at more than 150 stations within Alberta that record daily rainfall amounts. However, only about 20% of them continuously record rainfall data from which IDF curves can be derived. The locations of the recording stations are available through Environment Canada - Atmospheric Environment Service. Design intensity values for any selected duration and frequency can be read directly from the curves for the selected station. Locations in close proximity to any recording station can use the identical information extracted from the IDF curves. However, as important as close proximity is, the selected station should also have a similar elevation and surrounding terrain, as mountain and valley effects greatly influence precipitation data. Other sites may have to linearly interpolate data from two or more nearby sites. An alternative and more compact form of the information given by the IDF curves was published in 1985 by the AES as the Rainfall Frequency Atlas for Canada.

The rainfall intensity to be used in the design of erosion and sedimentation control measures is taken from a nearby intensity-duration-frequency (IDF) curve, t , for the particular watershed. Available methods to determine t_c from an IDF curve include the Airport Method, SCS Upland Method and Branby-Williams Method.

Table E.2: Rational Method Values

| LAND USE | C | LAND USE | C |
|-----------------------|-----------|---------------------------------|-----------|
| BUSINESS | | LAWNS | |
| Downtown areas | 0.70-0.95 | Sandy soil, flat 2% | 0.05-0.10 |
| Neighbourhood areas | 0.50-0.70 | Sandy soil, average 2-7% | 0.10-0.15 |
| | | Sandy soil, steep 7% | 0.15-0.20 |
| RESIDENTIAL | | Heavy soil, flat 2% | 0.13-0.17 |
| Single family areas | 0.30-0.50 | Heavy soil, average 2-7% | 0.18-0.22 |
| Multi units, detached | 0.40-0.60 | Heavy soil, steep | 0.25-0.35 |
| Multi units, attached | 0.60-0.75 | | |
| Suburban | 0.25-0.40 | AGRICULTURAL LAND, 0-30% | |
| | | BARREN PACKED SOIL | |
| INDUSTRIAL | | Smooth | 0.30-0.60 |
| Light areas | 0.50-0.80 | Rough | 0.20-0.50 |
| Heavy areas | 0.60-0.90 | | |
| Parks, cemeteries | 0.10-0.25 | CULTIVATED ROWS | |
| Playgrounds | 0.20-0.35 | Heavy soil, no crop | 0.30-0.60 |
| Railroad yard areas | 0.20-0.40 | Heavy soil, with crop | 0.20-0.50 |
| Unimproved areas | 0.10-0.30 | Sandy soil, no crop | 0.20-0.40 |
| | | Sandy soil, with crop | 0.10-0.25 |
| STREETS | | | |
| Asphalt | 0.70-0.95 | PASTURE | |
| Concrete | 0.80-0.95 | Heavy soil | 0.15-0.45 |
| Bricks | 0.70-0.85 | Sandy soil | 0.05-0.25 |
| Drives and walks | 0.75-0.85 | Woodlands | 0.05-0.25 |
| Roofs | 0.75-0.95 | | |
| | | BARREN SLOPES > 30%* | |
| | | Smooth, impervious | 0.70-0.90 |
| | | Rough | 0.50-0.70 |

Note: The Designer must use judgment to select the appropriate value of C within the range. Generally, large areas with permeable soils, flat slopes and dense vegetation should have lowest C values. Smaller areas with dense soils, moderate to steep slopes and sparse vegetation should be assigned highest C values.

* From Portland Cement Association, *Handbook of Concrete Culvert Hydraulics*, 1964, p.45.

APPENDIX F

GUIDELINES FOR DESIGN OF OPEN CHANNELS

THIS PAGE LEFT BLANK INTENTIONALLY.

FIGURES

- Figure F.1 Water Surface Profile of Channel with Uniform Flow
- Figure F.2 Manning's n for Class A Vegetation
- Figure F.3 Manning's n for Class B Vegetation
- Figure F.4 Manning's n for Class C Vegetation
- Figure F.5 Manning's n for Class D Vegetation
- Figure F.6 Manning's n for Class E Vegetation
- Figure F.7 Typical Shear Stress Distribution on Trapezoidal Channels
- Figure F.8 High Shear Stress Zones in Bends
- Figure F.9 Permissible Shear Stress for Cohesive Soils
- Figure F.10 Permissible Shear Stress for Cohesionless Soils
- Figure F.11 Steep Slope Riprap Design (Bed Width = 0 m, Sideslope = 3:1)
- Figure F.12 Steep Slope Riprap Design (Bed Width = 0.5 m, Sideslope = 3:1)
- Figure F.13 Steep Slope Riprap Design (Bed Width = 1.0 m, Sideslope = 3:1)
- Figure F.14 Steep Slope Riprap Design (Bed Width = 1.5 m, Sideslope = 3:1)
- Figure F.15 Permissible Shear of Gabion Mattress vs. Rock Fill Size
- Figure F.16 Permissible Shear of Gabion vs. Mattress Thickness
- Figure F.17 Steep Slope Gabion Design (Bed Width = 0 m, Sideslope = 3:1)
- Figure F.18 Steep Slope Gabion Design (Bed Width = 0.5 m, Sideslope = 3:1)
- Figure F.19 Steep Slope Gabion Design (Bed Width = 1.0 m, Sideslope = 3:1)
- Figure F.20 Steep Slope Gabion Design (Bed Width = 1.5 m, Sideslope = 3:1)

TABLES

| | |
|--------------|--|
| Table F.1 | Formulae for the Geometric Properties of Channels |
| Table F.2 | Manning's Roughness Coefficients, n |
| Table F.3(a) | Vegetation Retardance Classification |
| Table F.3(b) | Classification of Degree of Retardance for Various Kinds of Grasses |
| Table F.3(c) | Maximum Permissible Shear - Stress Values and Velocities for Various Materials |
| Table F.4 | Competent Mean Velocities for Cohesive Soils |
| Table F.5 | Field Soil Consistency Determination |
| Table F.6 | Consistency of Cohesive Soils Related to Standard Penetration Test Value, N |

F.1 Introduction

An open channel is any water conveyance route which allows a free passage of runoff, i.e., the surface is exposed to the atmosphere and hence at atmospheric pressure. Closed pipes, not flowing full, are also considered to act as open channels from a hydraulic perspective. Examples are all channels associated with roadway drainage, culverts flowing less than full and storm sewers flowing in a similar manner. Appropriate professionals should be consulted in the determination of channel flow.

F.2 Type of Flow

Flow variations result from changes in runoff rate due to changes in rainfall intensity, snow melt rate or ground water seepage. Similarly, variations in flow depth occur along the length of the channel. Factors accounting for these variations are inflow from the sides and changes in channel characteristics such as roughness, cross-section and bed slope.

In attempting to simplify the approach to hydraulic problems, two states of flow are defined - unsteady and steady. Unsteady flow occurs whenever there is a variation in the quantity of water flowing along the channel.

Steady flow requires the flow rate to be constant with time. Except under controlled laboratory conditions, most flows are unsteady. However, many hydraulic calculations can be simplified by assuming a steady flow state. This steady flow is taken as the maximum flow that the facility can reasonably be expected to handle without incurring excessive costs. For roadway erosion control work, the peak discharge from a 1:10 year storm is typically used when permanent structures are designed. Temporary structures require less stringent conditions for which a 1:5 year storm or even a 1:2 year storm will suffice for the less important ones.

Steady flow is further subdivided into uniform and non-uniform flow modes. With uniform flow, the depth of water and the mean velocity are constant along every section of the channel possessing such a condition. The depth is referred as the normal depth, d_n , shown in Figure F.1.

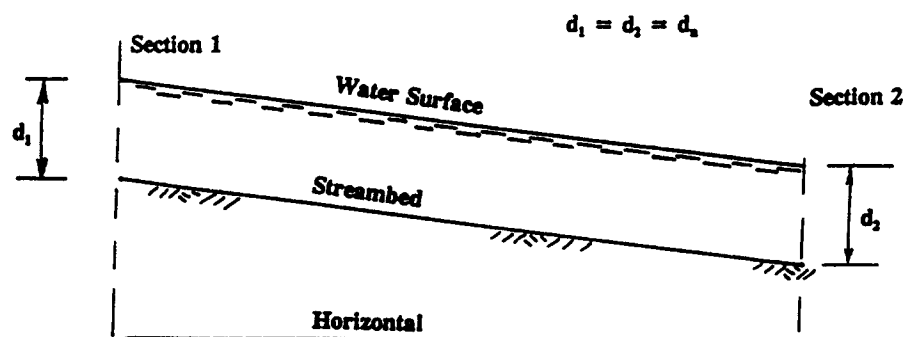

Figure F.1: Water Surface Profile of Channel with Uniform Flow

Uniform flow will occur when the following conditions are satisfied (otherwise the flow will be non-uniform).

- Channel cross-sectional area constant (including bottom width and sideslopes);
- Bed slope constant;
- Channel roughness uniform; and
- Steady flow rate.



Even with the above conditions satisfied, there will still be non-uniform flow in the transition areas at the beginning and the end of the channel section.

While uniform flow conditions are rare, the simplification leads to channel sizes and flow depths that produce realistic design cross-sections and its use is therefore justified. Further, the error incurred as a result of the simplification of the flow is often small compared to errors built into estimating procedures for the other parameters required for design such as peak discharge rate and channel roughness. An appropriate freeboard allowance to road subgrade is typically added to peak channel flow elevations to further ensure flows remain in the channel under design conditions.

F.3 Geometric Properties of Channels

The solution of uniform flow problems and other hydraulic calculations require an input of various geometric properties of the conducting channel such as bottom width, sideslopes, wetted perimeter and hydraulic radius. The properties in frequent use are defined below while Table F.1 provides formulae for the estimation of some of the properties for typical cross-sections.

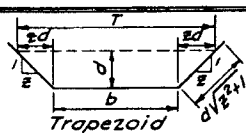
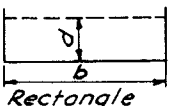
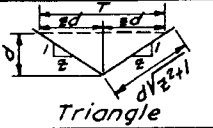
Table F.1: Formulae for the Geometric Properties of Channels

| Section | Area a | Wetted Perimeter P | Hydraulic Radius r | Top Width T |
|--|------------------|-------------------------|--|------------------|
|  <p>Trapezoid</p> | $bd + zd^2$ | $b + 2d\sqrt{z^2 + 1}$ | $\frac{bd + zd^2}{b + 2d\sqrt{z^2 + 1}}$ | $b + 2zd$ |
|  <p>Rectangle</p> | bd | $b + 2d$ | $\frac{bd}{b + 2d}$ | b |
|  <p>Triangle</p> | zd^2 | $2d\sqrt{z^2 + 1}$ | $\frac{zd}{2\sqrt{z^2 + 1}}$ | $2zd$ |
|  <p>Parabola</p> | $\frac{2}{3} dT$ | $T + \frac{8d^2}{3T}$ | $\frac{2dT^2}{3T^2 + 8d^2}$ | $\frac{3a}{2d}$ |

F.4 The Manning Equation for Uniform Steady Flow

A simple equation relating the velocity of flow under uniform conditions to the properties of a channel was developed by Robert Manning. The equation is:

$$V = (1 / n) \times R^{2/3} \times s^{1/2} \quad (\text{Equation F.1})$$

Where: V = velocity of flow (m/s)
n = channel roughness (dimensionless)
R = hydraulic radius, A/P (m)
A = cross-sectional area of flow (m²)
P = wetted perimeter (m)
s = channel bed slope (m/m)

From the above equation, the velocity of flowing water along the channel can be estimated under uniform flow condition. The importance of this estimation lies in the fact that the amount of water flowing along any channel can be evaluated using the cross-sectional area of flow and the estimated velocity.

F.5 Manning Roughness Coefficient, n

This parameter is dependent on the degree of retardance of a channel treatment. Estimates of the parameter have been made on an empirical basis for various materials and values obtained published for design purposes. Table F.2 provides a listing of values in current use for channels with various bed materials except vegetation. Roughness values for vegetation are obtained graphically as discussed below.

For most materials, the roughness value remains virtually constant when the flow depth exceeds 600 mm. However, in erosion control work along roadways, the flow depth is almost always less than 600 mm and appropriate 'n' values which change with flow depth must be used in design. In the case of rock riprap, gravels and many of the manufactured ditch lining materials, the change in n values with the flow depth is very pronounced.

Vegetation adds another dimension to the roughness problem along ditches. Stems projecting into the flow produce roughness as other materials do. The extent to which the vegetation allows the flow to go through varies with the magnitude of the flow and the type of vegetation. Thus the roughness of the ditch changes with the depth of flow through it and the type of vegetation along it.

Manning's n becomes an even more variable quantity with vegetated channels than with non-vegetated ones.

Table F.2: Manning's Roughness Coefficients (n)

| Lining Category | Lining Type | n - value Depth Ranges | | |
|-----------------|--------------------------|------------------------|-----------|----------|
| | | 0-15 cms | 15-60 cms | > 60 cms |
| Rigid | Concrete | 0.015 | 0.013 | 0.013 |
| | Grouted riprap | 0.040 | 0.030 | 0.028 |
| | Stone masonry | 0.042 | 0.032 | 0.030 |
| | Soil cement | 0.025 | 0.022 | 0.020 |
| | Asphalt | 0.018 | 0.016 | 0.016 |
| Unlined | Bare soil | 0.023 | 0.020 | 0.020 |
| | Rock cut | 0.045 | 0.035 | 0.025 |
| Temporary* | Woven paper net | 0.016 | 0.015 | 0.015 |
| | Jute net | 0.028 | 0.022 | 0.019 |
| | Fibreglass roving | 0.028 | 0.021 | 0.019 |
| | Straw with net | 0.065 | 0.033 | 0.025 |
| | Curled wood mat | 0.066 | 0.035 | 0.028 |
| | Synthetic mat | 0.036 | 0.025 | 0.021 |
| Gravel riprap | D ₅₀ = 2.5 cm | 0.044 | 0.033 | 0.030 |
| | D ₅₀ = 5 cm | 0.066 | 0.041 | 0.034 |
| Rock riprap | D ₅₀ = 15 cm | 0.104 | 0.069 | 0.035 |
| | D ₅₀ = 30 cm | ----- | 0.078 | 0.040 |

Note: Values listed are representative values for the respective depth ranges. Manning's roughness coefficient, n, varies with the flow depth.

* Some "temporary" linings become permanent when buried.

Source: Chen & Cotton, 1988 R.L. Cox, et al., 1971
 N. Kouwen, et al., 1980 J.C. McWhorter, et al., 1968
 A.G. Anderson, et al., 1970 K.G. Thibodeaux, 1982-85

To resolve the problems associated with estimates of flow through vegetation-lined channels, the Soil Conservation Service (SCS) of the U.S. Department of Agriculture have identified five classes of vegetation, designated retardance classes A to E as shown in Tables F.3(a) and F.3(b). While Table F.3(a) shows a simplified generic classification, Table F.3(b) indicates the detailed classification proposed by the SCS. All types of vegetation are assigned a classification based on growth height and stand density, and this grouping is used to determine an appropriate roughness value.

Table F.3(a): Vegetation Retardance Classification

| Vegetation Height and Density | Retardance Class |
|-------------------------------|------------------|
| < 50 mm, good stand | E |
| 50-150 mm, fair stand | |
| 50-150 mm, good stand | D |
| 150-250 mm, fair stand | |
| 150-250 mm, good stand | C |
| 250-600 mm, fair stand | |
| 250-600 mm, good stand | B |
| > 600 mm, fair stand | |
| > 600 mm, good stand | A |

Table F.3(b): Classification of Degree of Retardance for Various Kinds of Grasses *

| Retardance | Cover | Condition |
|-------------|--|---|
| A Very high | Weeping love grass | Excellent stand, tall (av. 760 mm) |
| | Yellow bluestem <i>ischaemum</i> | Excellent stand, tall (av. 760 mm) |
| | Kudzu | Very dense growth, uncut |
| | Bermuda grass | Good stand, tall (av. 300 mm) |
| | Native grass mixture (little bluestem, blue gramma and other long and short Midwest grasses) | Good stand, unmowed |
| B High | Weeping love grass | Good stand, tall (av. 510 mm) |
| | <i>Lespedeza sericeus</i> | Good stand, not woody, tall (av. 480 mm) |
| | Alfalfa | Good stand, uncut (av. 280 mm) |
| | Weeping love grass | Good stand, mowed (av. 330 mm) |
| | Kudzu | Dense growth, uncut |
| | Blue gramma | Good stand, uncut (av. 330 mm) |
| | Crab grass | Fair stand, uncut (250 - 1220 mm) |
| | Bermuda grass | Good stand, mowed (av. 150 mm) |
| | Common <i>lespedeza</i> | Good stand, uncut (av. 250 mm) |
| | Grass-legume mixture - summer (orchard grass) | |
| C Moderate | red top, Italian rye grass, and common <i>lespedeza</i> | Good stand, uncut (150 - 200 mm) |
| | Centipede grass | Very dense cover (av. 150 mm) |
| | Kentucky blue grass | Good stand, headed (150 to 300 mm) |
| | Bermuda grass | Good stand, cut to 64 mm height |
| | Common <i>lespedeza</i> | Excellent stand, uncut (av. 110 mm) |
| | Buffalo grass | Good stand, uncut (76 to 150 mm) |
| | Grass-legume mixture - fall (orchard grass) | |
| D Low | Red top, Italian rye grass, and common <i>lespedeza</i> | Good stand, uncut (100 - 130 mm) After cutting to 50 mm height |
| | <i>Lespedeza sericeus</i> | Very good stand before cutting |
| E Very low | Bermuda grass | Good stand, cut to 38 mm height |
| | Bermuda grass | Burned stubble |

Note: Provided for design guidance only.

Source: U.S. Soil Conservation Service, 1986
Chen & Cotton, 1988

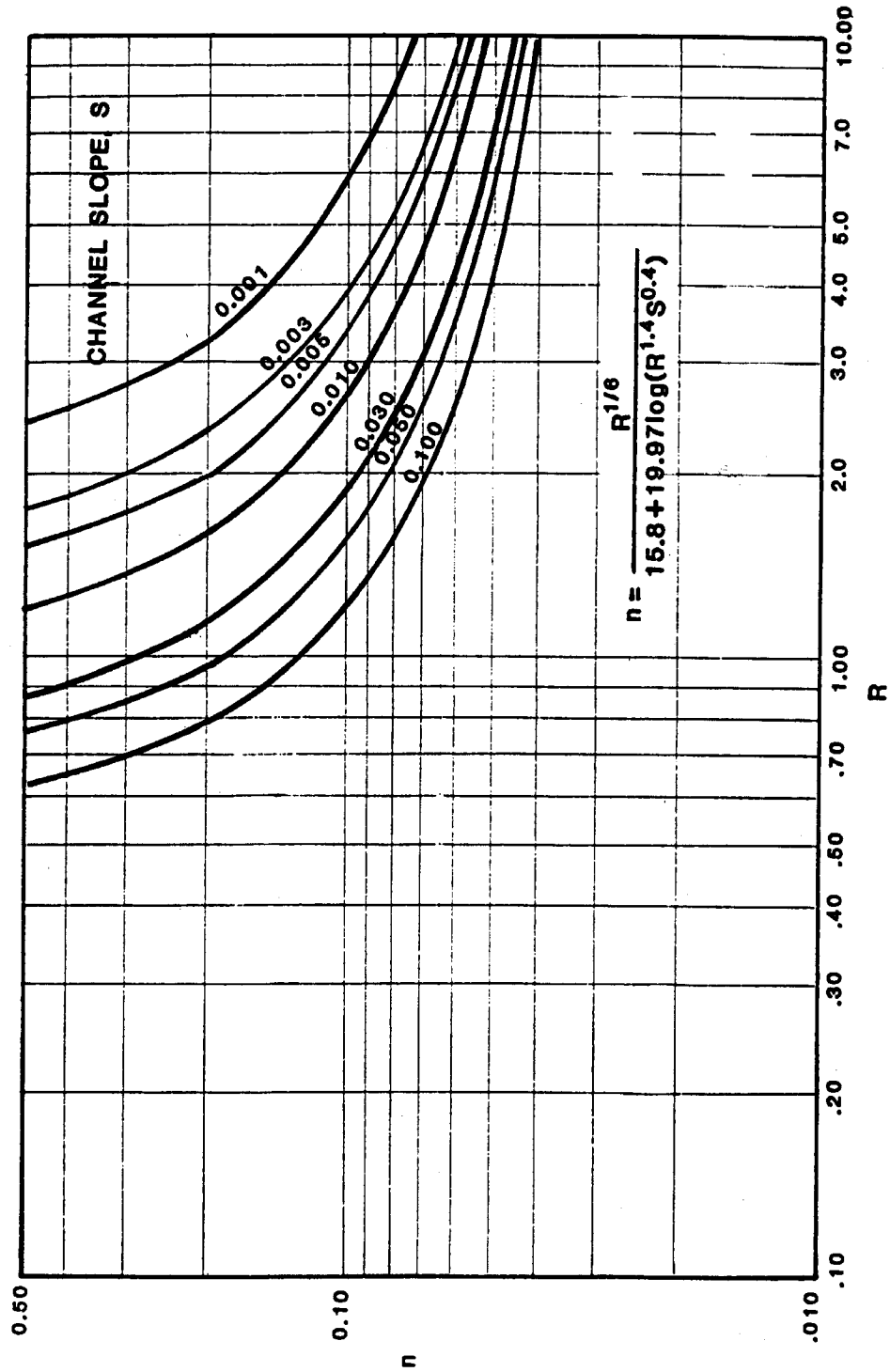

Figure F.2 Manning's n for Class A Vegetation
 (Note: hydraulic depth (R) in feet)

Source: N. Kouwen, et al., 1980

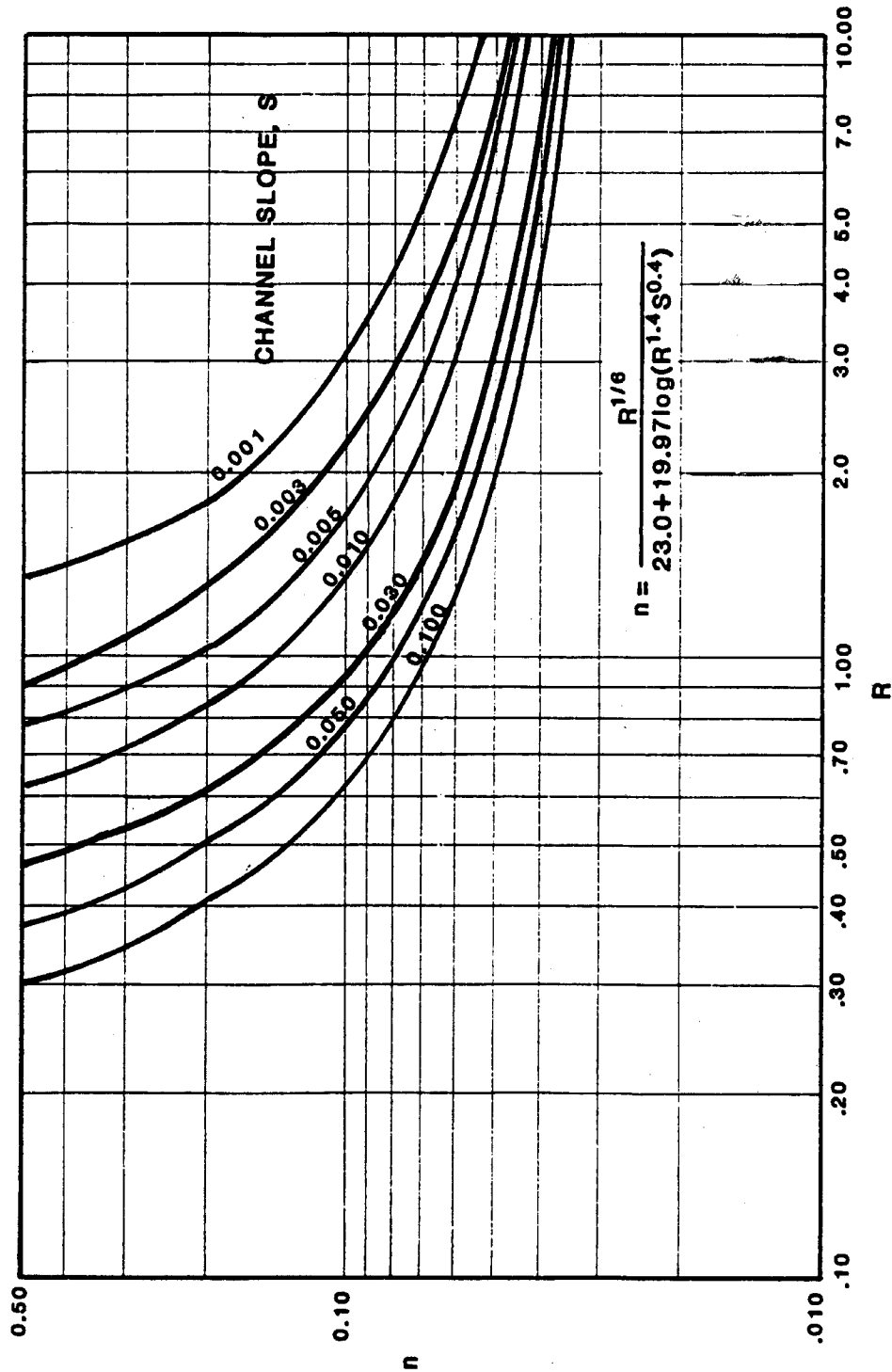

Figure F.3 Manning's n for Class B Vegetation
 (Note: hydraulic depth (R) in feet)

Source: N. Kouwen, et al., 1980

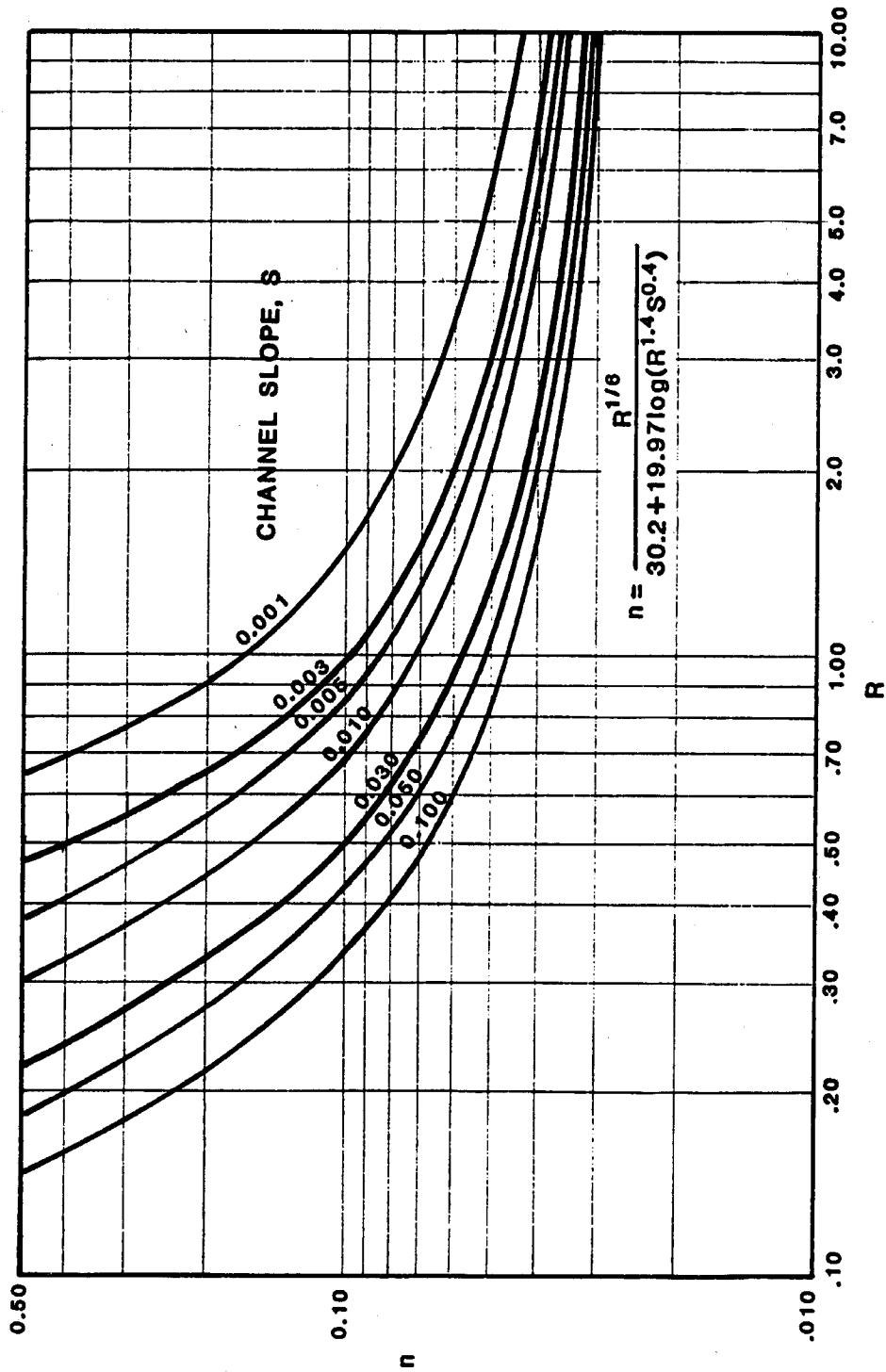

Figure F.4 Manning's n for Class C Vegetation
 (Note: hydraulic depth (R) in feet)

Source: N. Kouwen, et al., 1980

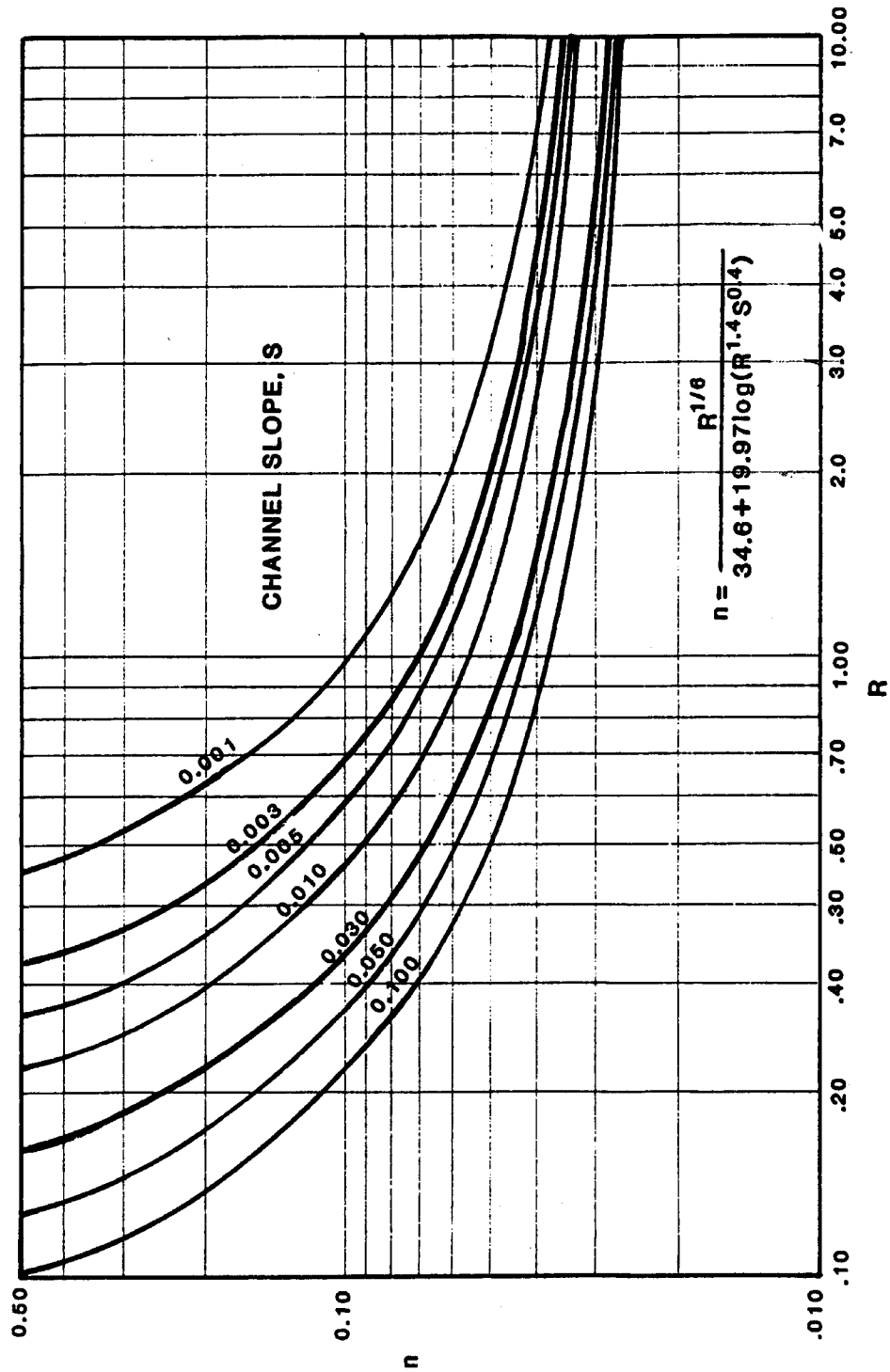

Figure F.5 Manning's n for Class D Vegetation
 (Note: hydraulic depth (R) in feet)

Source: N. Kouwen, et al., 1980

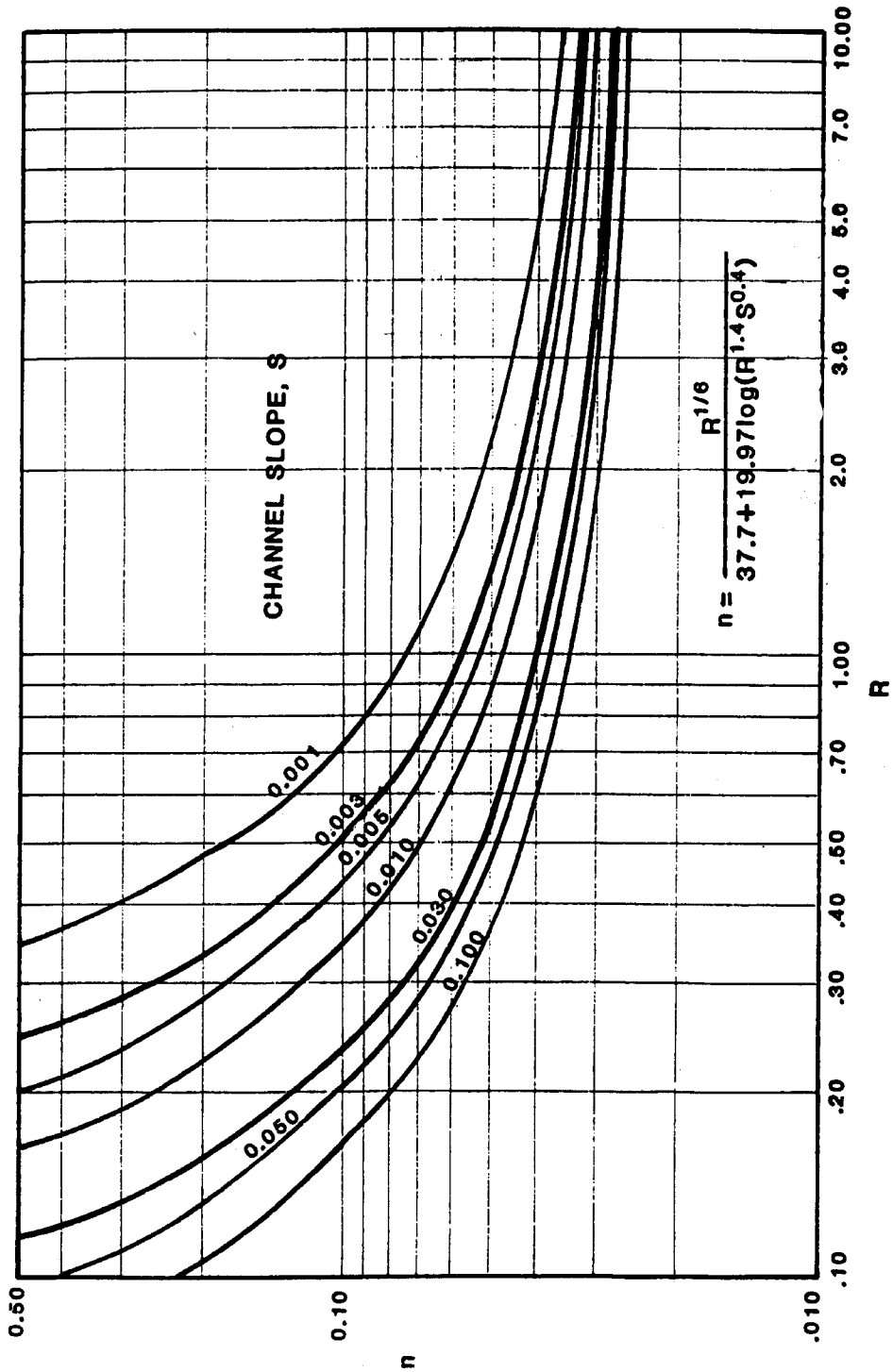

Figure F.6 Manning's n for Class E Vegetation
 (Note: hydraulic depth (R) in feet)

Source: N. Kouwen, et al., 1980

Table F.3(c): Maximum Permissible Shear – Stress Values and Velocities for Various Materials

| Materials | Test Time (hr) | Performance Properties | |
|--|----------------|--|--|
| | | Maximum Permissible Shear Stress (N/m ²) | Maximum Permissible Velocity (m/s) |
| Bare soil ^a (see Figure F.12) (*Table F.3d) | | | |
| Noncohesive (Dia. = 0.1 – 25 mm) | NDG | 1.5 – 20 | 0.46 – 0.76* |
| Cohesive (P.I. = 4 – 50) (see Figure F.11) (Table F.3d) | NDG | 0.5 – 38 | 0.52 – 1.13* 1.8 (hard pan) |
| Gravel riprap ^a (*Table F.3(d)) | | | |
| D ₅₀ = 25 mm (thickness t = 2D ₅₀) | NDG | 15.8 | 0.76 – 1.13* |
| D ₅₀ = 50 mm (thickness t = 2D ₅₀) | NDG | 31.6 | 1.13 – 1.22* |
| Rock riprap ^a (** Table F.3(e)) | | | |
| D ₅₀ = 150 mm (thickness t = 1.5D ₅₀) | NDG | 95.8 | 2.2 ** |
| D ₅₀ = 300 mm (thickness t = 2D ₅₀) | NDG | 191.5 | 3.0 ** |
| Gabion Mattress (***) Table F.3(f)) | | | V _{critical} – V _{limit} |
| thickness = 0.25 m; D ₅₀ = 120 mm | NDG | 200 | 4.5 – 6.1 *** |
| thickness = 0.30 m; D ₅₀ = 150 mm | NDG | 230 | 5.0 – 6.4 *** |
| thickness = 0.50 m; D ₅₀ = 190 mm | NDG | 250 | 6.4 – 8.0 *** |
| Grass (established) ^a (Table F.3g) | NDG | 16.8 – 177.2 | 0.8 – 2.4 |
| Vegetative | | | |
| Class A Retardance | NDG | 177.2 | |
| Class B Retardance | NDG | 100.6 | |
| Class C Retardance | NDG | 47.9 | |
| Class D Retardance | NDG | 28.7 | |
| Class E Retardance | NDG | 16.8 | |
| Fiberglass roving ^a (SOP) | | | |
| Single | NDG | 28.7 | NDG |
| Double | NDG | 40.7 | NDG |
| Straw (loose) covered with net ^a | NDG | 69.4 | NDG |
| EROSION CONTROL MAT (ECM) | | | |
| Coconut material ^c | 0.5 | 143 | 3.0 – 4.6 |
| Wood excelsior material ^a | NDG | 74.2 | NDG |
| Jute net ^a | NDG | 21.5 | NDG |
| Straw blanket with sewn net ^c | 0.5 | 95.7 – 105 | 1.8 – 3.0 |
| Straw/coconut blanket ^c | 0.5 | 120 | 3.0 |
| TURF REINFORCEMENT MAT (TRM) | | | |
| Bare ground conditions ^{a,b} | 0.5 | 239 – 287 | 5.5 – 8.2 |
| | 50 | 95.6 | 2.4 |
| Vegetation established ^b | 0.5 | 100 – 380 | 5.5 |
| growth period ≥ 36 mos. & growth density dependent | 50 | 100 – 239 | 3.0 |
| COMPOSITE TURF REINFORCEMENT MAT (C-TRM) | | | |
| Bare ground conditions ^b | 0.5 | 239 | 3.7 |
| | 50 | 95.6 | 2.1 |
| Vegetation established ^b | 0.5 | 382 | 6.1 |
| | 50 | 239 | 4.3 |

^a From Chen and Cotton (1988)

^b From IECA (1991, 1992, 1995)

^c As reported by manufacturer

Notes:

- i) NDG = No data given
SOP = Spray-on-Product (s.a., mulch)
 V_c = Critical Velocity
 V_l = Limit Velocity
- ii) RECP types include ECM, TRM, C-TRM
For use of RECP products, product certification on performance and physical properties are required from suppliers.
Performance of RECP will depend on Final Density of Vegetation Growth after installation and the growth period specified.
- iii) Relationship of shear stress not linear with flow velocity; select lining based on permissible tractive resistance.
- iv) Performance values given are limited to flow of 1.4 m³/s.

F.6 Channel Discharge Equation

The discharge (Q) of a channel is related to the velocity and the cross-sectional area of flow through the continuity equation:

$$Q = A \times V \quad \text{(Equation F.2)}$$

Where: Q = discharge (m³/s)
A = cross-sectional area of flow (m²)
V = velocity of flow (m/s)

With uniform flow, V in above equation can be replaced by Manning's expression to arrive at the following revised continuity equation for uniform flow.

$$Q = A[(1 / n) \times R^{2/3} \times s^{1/2}] \quad \text{(Equation F.3)}$$

Knowing the geometric shape of a channel and the depth of flow, the cross-sectional area, A, and the hydraulic radius, R, can both be evaluated. Additionally, if the bed slope, s, and the channel roughness, n, are known, the entire right half of the equation can be quantified, providing an estimate for the discharge, Q.

F.7 Design Channel Dimensions

Channel design involves a reverse process to the discharge estimation procedure outlined above. The discharge is known from hydrological calculations and appropriate channel dimensions have to be determined to ensure satisfactory flow conveyance.

Inputting known values of Q , n and s into the revised continuity equation leads to a value of the quantity, $AxR^{2/3}$, which cannot be solved directly to provide flow depth and bed width estimates. Thus the design of channels using Manning's equation requires an iterative process. Briefly the procedure is as follows:

- An appropriate channel shape and bed width is chosen, taking into consideration the geometric and other requirements of the roadway;
- Evaluate channel discharge using Manning Equation (Equation F.1) based on the assumed geometric properties;
- Compare evaluated discharge with design discharge;
- Adjust original geometric parameter assumptions and recalculate channel discharge;
- Continue this procedure until congruence between calculated and design discharges occur.

This procedure is illustrated in Appendix H as design examples H.8 to H.10 and H.12. Various nomographs and computer program are available to assist in solving Manning's equation.

F.8 Approaches to Controlling Soil Erosion

There are two types of design approaches for the design of open channels depending on whether or not siltation or erosion are considerations in design. In the first approach, the material that comprises the channel and sideslopes is assumed to be in dynamic equilibrium with the silt laden water of the stream. A regime state prevails with erosion and deposition occurring at the same rate over the long-term resulting in a stable channel section with no real loss or gain of material. This approach is called the Permissible Velocity Method.

Such an approach is necessary when sediment laden water is required to be handled in earthen channels as unacceptable erosion or deposition of bed material can occur. Typically this approach is applicable to drainage and irrigation systems, and river realignments.

The second approach, called the Tractive Stress Method, assumes that the material that comprises the channel boundary is capable of resisting soil loss through erosion, and the channel size will be determined for carrying the design flow. Most open channels carrying clear water, including roadside ditches, are designed using this approach.

With erodible bed material such as some natural soils, the design is complete by checking the assumption of non-occurrence of erosion. If erosion is found likely to occur, the channel is redesigned using larger channel sizes, gentler bed slope if possible, or armouring along the bed and sideslopes to resist any erosion.

F.9 Permissible Velocity Method

The need to check whether or not soil erosion will occur was recognized early in the design of open channels. Engineers originally approached the problem by defining limiting velocities to which a bed material can be subject to. Channel design proceeded

by limiting the flow velocities along them to values lower than the permissible velocities. Alternatively, protection of the channel was provided using some form of channel lining.

If it is possible to design the channel to flow with a velocity less than the competent mean velocity of the native soil, soil erosion should not be a major problem. However, there may be erosion of the exposed earth due to rainfall and other weathering processes. Due to potential problems with silt that can occur, unlined channels must be regularly maintained.

The permissible velocity method was historically adopted for channel assessment. Recent developments recognized and utilized tractive stress method as an acceptable hydraulic assessment method (see Section F.10).

Table F.4: Competent Mean Velocities for Cohesive Soils*

| Depth of Flow (m) | Soil Scourability ** | | | Remarks Normal Ditch Flow for Highway |
|----------------------|----------------------|-----------------|--------------|---|
| | High (m/s) | Medium (m/s) | Low (m/s) | |
| 1.0 | 0.5 | 0.9 | 1.6 | 0.3 |
| 1.5 | 0.6 | 1.0 | 1.8 | N/A |
| 3 | 0.6 | 1.2 | 2.0 | N/A |
| 6 | 0.7 | 1.3 | 2.3 | N/A |
| 15 | 0.8 | 1.5 | 2.6 | N/A |

Source: RTAC Drainage Manual 1987

Notes:

* Competent velocities should be based on local experience whenever possible, taking into account saturation and weathering.

** It is not considered advisable to relate the tabulated values to soil property indices because of the strong effect of saturation and weathering on the scourability of the soils. However, the following tentative relationship to consistency is offered as a rough guide.

| | |
|---------------------|---|
| High scourability | - very soft to soft clays |
| Medium scourability | - firm to stiff clays |
| Low scourability | - stiff to hard clays, some glacial tills |

See Table F.5 for soil consistency determination.

F.10 TRACTIVE STRESS METHOD

In the 1950's, it was recognized that the permissible velocity approach, though successfully used in the design of open channels, does not reflect the physical phenomenon of soil erosion. It was postulated that erosion occurs as a result of the shear force exerted by water flowing over the bed and sideslopes of a channel. While the velocity of flow bears a relationship to the shear force exerted, the relationship is not linear, i.e., equal increases in velocities does not produce a corresponding increase in shear force.

Attention was then focused on the development of a method for the evaluation of the applied hydraulic shear and to ensure that the bed material is capable of withstanding the applied stress. This led to the development of the Tractive Stress Theory.

The Tractive Stress Theory, as related to open channels, simply states:

$$\text{applied tractive shear stress} \leq \text{critical shear stress}$$

Under uniform flow conditions, the applied tractive stress exerted by flowing water is given by:

$$\tau = \delta \times R \times s \quad (\text{Equation F.4})$$

Where: τ = Tractive stress (kPa)
 δ_w = Unit weight of water (kN/m³)
 R = Hydraulic radius (m)
 s = Bed slope (m/m)

Maximum tractive stress induced by any flow occurs at the point of greatest depth or at the centre of any channel with horizontal bed is given by the equation:

$$\tau_{\max} = \delta_w \times d \times s \quad (\text{Equation F.5})$$

Where: d = Depth of channel (m)

The critical shear stress is a property of the material comprising the channel boundary. It is defined as the limiting hydraulic shear stress that can be applied to a material to initiate significant soil erosion or material failure in the case of ditch linings.

Natural soils possess varying critical shear stress capacity and the process of design involves evaluating this capacity and limiting the tractive stress to a value less than the capacity evaluated. Similarly, various commercially available lining materials have differing critical shear stress capacities and hence the tractive stress must be limited in a similar manner to the critical stress of the lining.

The effect of concentrated flows in channels in terms of their erosion tendency on the materials (natural soil or erosion control lining) comprising the channel bed and sideslopes, is discussed in more detail in Sections F.12 to F.14.

F.11 Distribution of Tractive Stress

F.11.1 Straight Sections with Uniform Flow

In any given channel, the tractive stress is not uniform across the channel bed. Variations occur across the entire cross-section of the channel. Typically, for a trapezoidal channel, the stress variation occurs as shown in Figure F.2. Maximum values occur at the centre of the section and reduce gradually and then abruptly to zero at each corner. Along the sideslopes, maximum values occur at approximately two-thirds the depth of flow with magnitudes of $0.75\tau_{\max}$.

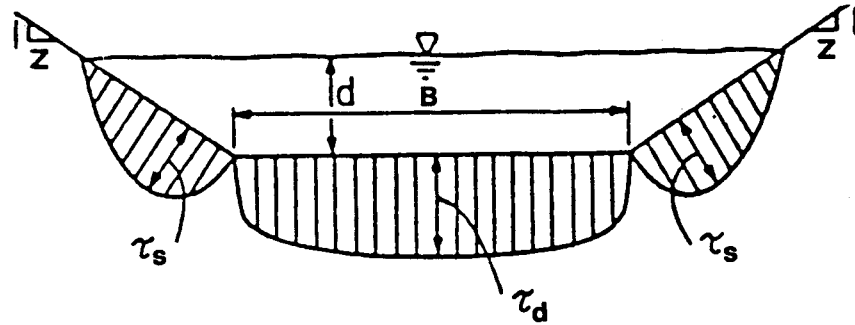

Figure F.7: Typical Shear Stress Distribution on Trapezoidal Channels

Note: $\tau_s = 0.75 \delta d s = 0.75 \tau_{max}$
 $\tau_d = 0.97 \delta d s = \tau_{max}$
 $\delta_w = \text{Unit weight of water}$
 $d = \text{Depth of water}$
 $s = \text{Channel gradient}$

Source: Chow 1959

F.11.2 Bends

The changing flow paths along a bend in a channel induce additional shear stress at the shaded locations shown in Figure F.3. Upstream of a bend, the additional shear occurs along the inside, while downstream, the greater shear moves toward the outside. Downstream, the additional shear persists for some distance beyond the bend. Protection of the channel may be required for some distance, L_p , beyond the bend as given by the equation below.

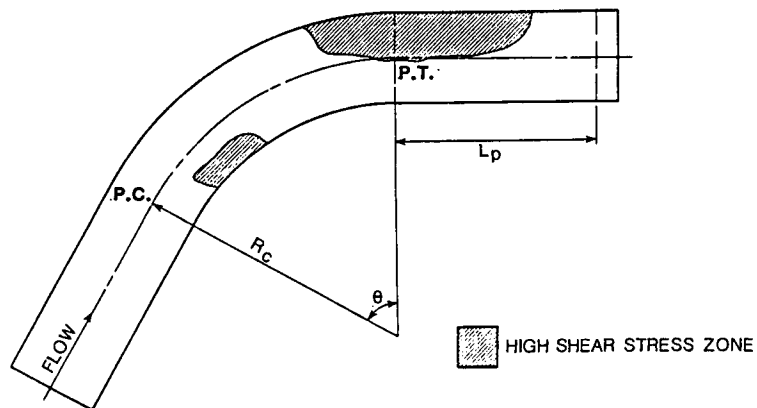

Figure F.8: High Shear Stress Zones in Bends

Source: Nough & Townsend, 1979

$$L_p / R = (0.694 \times R^{1/6}) / n_b \quad (\text{Equation F.6})$$

Where: L_p = Length requiring protection
 R = Hydraulic radius
 n_b = Manning's roughness coefficient in bends

F.12 Resistance of Bare Soil to Erosion from Concentrated Flows

The behaviour of a soil is largely influenced by its composition. Such composition can range from completely granular material such as cobbles, gravel and sands to completely flat, plate-shaped, microscopic clayey particles. Most soils comprise a mixture of granular and clayey particles and the overall behaviour of such a soil will be dependent on the influence of each fraction comprising the soil.

Experience has found it convenient to separate naturally occurring soils into cohesive and cohesionless materials based on particle size distribution and plasticity. The convenience arises from the fact that many characteristics of a soil can be inferred from the plastic behaviour of cohesive soils and the grain size distribution of cohesionless soils.

F.12.1 Permissible Shear Stress

Any soil subjected to the flow of water over it experiences a shear stress along its surface which acts to dislodge soil particles. Initially, with low shear stress, the soil may be capable of resisting the flow. Thus the bed and sideslopes remain stable. With increasing flow depth, there comes a time when the shear stress imposed by the flow on the channel bed is capable of dislodging soil particles into suspension. The shear stress at which this soil loss first occurs is referred to as the Critical Shear Stress and represents the maximum hydraulic shear stress to which the soil can be subjected. For design purposes, the critical shear stress is regarded as the Maximum Permissible Shear Stress.

As an extension of the concept, critical shear also occurs on manufactured channel linings. In this case, the critical shear is interpreted as either the hydraulic shear causing lining failure or rapid soil loss. Permissible shear is similarly taken as the maximum stress to which a lining can be subjected before the onset of failure.

F.12.2 Cohesive Soils

Numerous investigators have looked at the problem of cohesive soil erodibility in attempts to obtain correlations between the critical shear stress and the properties of a soil. Some of the properties identified as influencing soil erodibility are:

- Mineralogical composition
- Chemical composition of the fluid surrounding soil particles
- Sodium Absorption Ratio (SAR)

- Degree of compaction
- Plasticity

At present, no procedure exists for evaluating the critical shear stress that takes into consideration all the identified variables. Even if such a procedure existed, it would not be very valuable for design purposes as the many factors that affect soil erosion are difficult to determine. Cost would be the influencing factor.

An acceptable method using two parameters is available to evaluate the permissible shear stress of a cohesive soil. One of these parameters, the plasticity index, is routinely determined by the designer in their routine soil investigation and testing. The other parameter, compaction, as measured by the blow count, N, on the Standard Penetration Test is not as routinely evaluated. However, an estimate of the N value can be made by the feel of the sample when worked between the fingers. Alternatively, a simple hand-held soil investigation tool called a Pocket Penetrometer can be used as a more accurate determination. In theory, the penetrometer measures undrained shear strength which can be related to the blow count, N, as shown in Table F.6.

In the absence of any data on soil compactness, a subjective evaluation of the N parameter will be required. As a guide, the consistency of the soil can be determined in the field using simple test as given below. Then using Table F.6, an appropriate N value can be selected for use in Figure F.4 to determine the permissible tractive shear stress of the soil.

Table F.5: Field Soil Consistency Determination

| | |
|------------|--|
| Very soft | Easily penetrated several centimetres by the fist |
| Soft | Easily penetrated several centimetres by the thumb |
| Medium | Moderate effort to penetrate several centimetres by the thumb |
| Stiff | Readily indented by the thumb, but penetrated only with great effort |
| Very stiff | Readily indented by the thumb nail |
| Hard | Indented with difficulty by the thumb nail |

Table F.6: Consistency of Cohesive Soils Related to Standard Penetration Test Value, N

| Consistency | Standard Penetration Value, N |
|-------------|-------------------------------|
| Very soft | 0 - 2 |
| Soft | 2 - 4 |
| Medium | 4 - 8 |
| Stiff | 8 - 16 |
| Very stiff | 16 - 32 |
| Hard | > 32 |

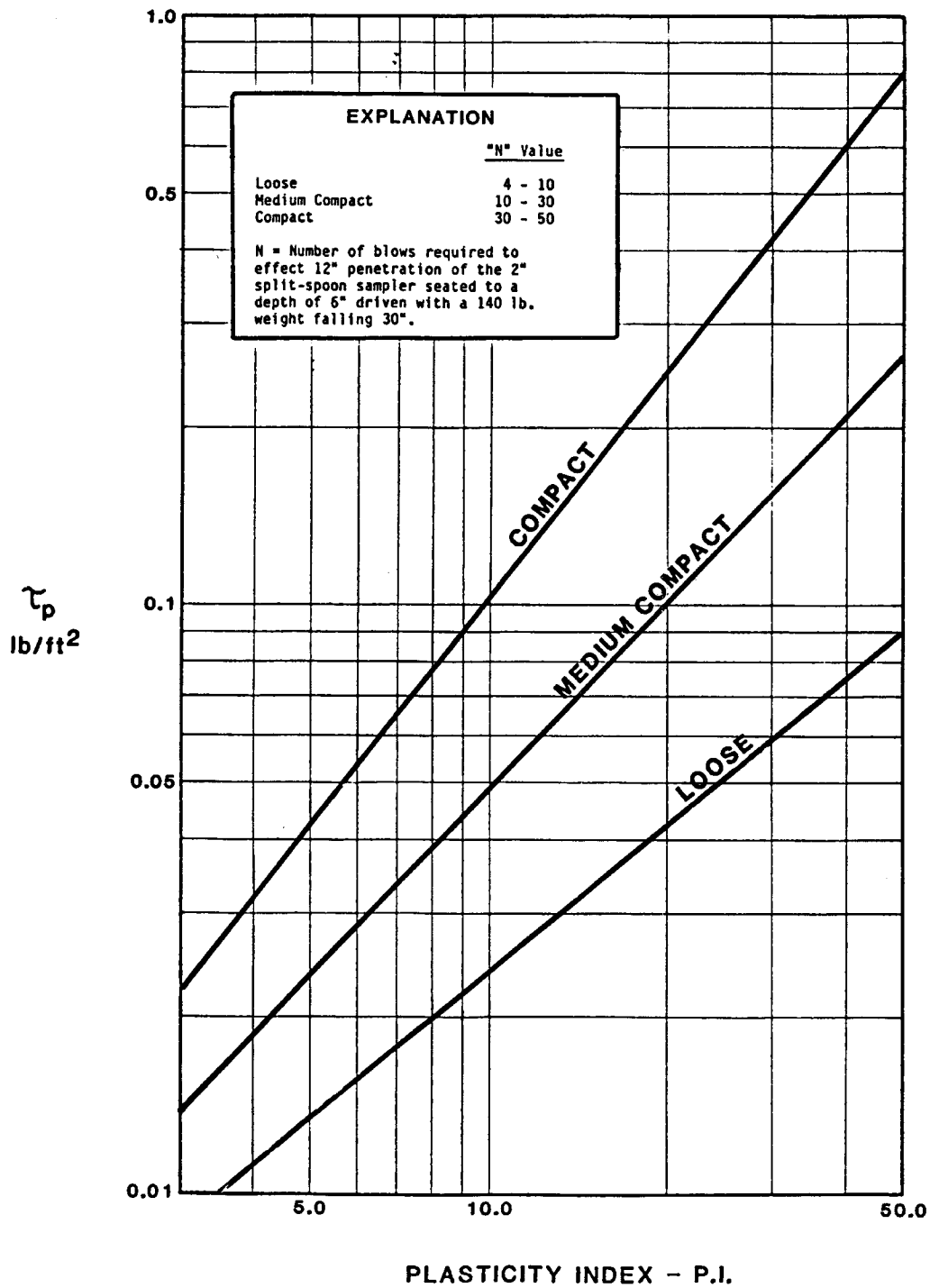

Figure F.9: Permissible Shear Stress for Cohesive Soils

Source: Smerdon & Beaseley, 1959

Note: 1 lb/ft² = 48 N/m²

F.12.3 Cohesionless Soils

With cohesionless soils, the particles are relatively inert and erodibility is dependent mainly on the grain size distribution. Tests carried out on various cohesionless soil samples have shown that the permissible shear stress can be related to the mean particle size of the sample as shown in Figure F.5. Thus it is a simple matter of assessing the mean particle size from a grain size distribution curve to determine the permissible shear stress.

For particles larger than 100 mm, τ_p , can simply be evaluated by the equation:

$$\tau_p = 6.25 \times 10^{-4} D_{50} \quad (\text{Equation F.7})$$

Where: τ_p = permissible shear stress (kPa)
 D_{50} = mean particle diameter (mm)

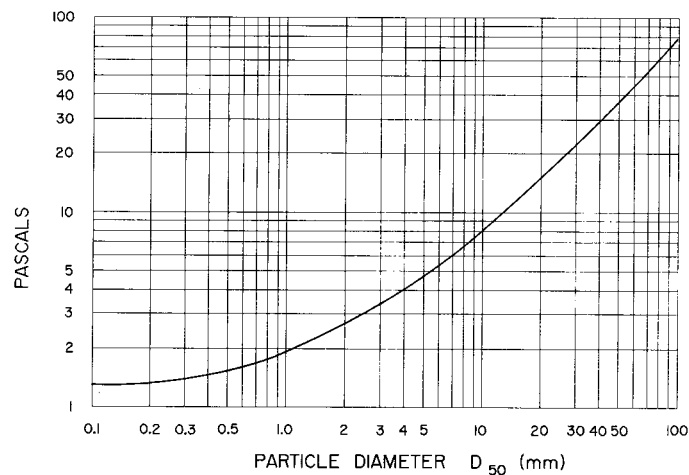

Figure F.10: Permissible Shear Stress for Cohesionless Soils

Source: Thibodeaux 1982-1985

F.13 Resistance of Vegetation to Concentrated Flow

The most widely used method for permanently controlling soil erosion, both on slopes and along ditches is the establishment of vegetation. Because of the relatively low cost, vegetation is the first and sometimes erroneously the only choice among soil erosion control practitioners.

There is a limitation to the extent to which vegetation will be successful in controlling soil erosion along ditches. Unless the limitation is defined, many instances will occur in which vegetation will prove to be inadequate for the function intended.

The determination of the appropriateness of vegetation for soil erosion control along ditches is rather simple. It entails comparing the tractive resistance of the proposed vegetation with the shear stress exerted by the design flow. Vegetation will be adequate if the shear stress of the flow is less than the resistance of the vegetation.

There is one additional complexity in the calculation process introduced by a vegetative lining. The degree of flexibility and variations in growth height of various grasses and legumes normally used for the control of erosion vary with the different species. Further, the mowed height of the vegetation also affects roughness. As such, the roughness coefficient, n , an input into Manning's Equation is not a constant.

F.14 Resistance of Non-Vegetative Linings to Soil Erosion

Non-vegetative ditch linings used for soil erosion control are of two types:

- Temporary; and
- Permanent.

Temporary linings are to be considered for use only at those locations in which vegetation growth is expected to take over the erosion control function in the future. Conversely, in sterile areas or those locations expected to experience larger hydraulic shear stresses than can be handled by vegetation, permanent erosion controls are required.

The approach to designing erosion control in either case is to compare the shear resistance of the lining with the tractive stress of the design flow. The lining selected should have a shear resistance greater than the flow shear stresses. However, when the channel gradient becomes steep (say greater than 10%) and the lining selected is a weighty material (such as gravels and rock riprap), special design procedures are required as the lining on the channel bed and more so on the sideslopes provides an additional de-stabilizing force component down slope. Procedures for such design are given in Section F.18.

Other permanent linings, such as articulating blocks that rely not only on their weight but also on their inter-connection with each other for their stability, must have their design based on the recommendations of the manufacturers. These recommendations will usually be deduced from the results of hydraulic tests carried out on the linings for performance evaluation.

Many manufactured materials are currently available for soil erosion control. Most of them are bio-degradable although some permanent ones are available.

F.15 Flexible Lining Design

Flexible linings, while not always applicable, are capable of handling most of the soil erosion problems along provincial roadways. Additionally, flexible linings are more versatile than rigid linings because of their ability to accommodate minor distortions in the subgrade without leading to failure. This property, in particular, makes them the preferred choice among ditch linings.

A word of caution in the use of lining materials be they rigid or flexible. Linings ought not to be placed onto unstable slopes as the lining material will soon separate at one or more of the crack locations which normally appear when instability occurs on a slope. The gap so created will render the lining ineffective. In fact, the lining may aggravate the instability by conducting water into the unstable mass.

The design procedure is a three step evaluation from which a decision is made at the end of each step regarding the need for the succeeding step. The three steps are given in the following paragraphs.

Step 1: Assess the capability of the in-situ soil to withstand the erosive forces of flowing water. If adequate, use seed, fertilizer, harrow or mulch as required to establish vegetation. Sediment retention structures may be required to control sediment loss to areas beyond right-of-ways.

Proceed to Step 2 if in-situ soil cannot withstand erosion.

Step 2: Assess the capability of vegetation to control soil erosion. If adequate, provide temporary lining to control erosion while vegetation is being established.

Proceed to step 3 if vegetation cannot control the erosion.

Step 3: Design permanent erosion control measure (flexible or rigid), depending on local factors such as economy, ease of installation, availability of materials, maintenance costs, etc. The advantages and limitations of each lining types should be considered for situations of flow, slope, vegetation growth density, and soil type of specific soil conditions.

F.16 Rigid Lining Design

Rigid channel linings, because of cost, are only considered for erosion control when special conditions prevail that would preclude the use of other linings. Examples of such conditions are:

- Steep grade;
- Limited right-of-way;
- Appropriate flexible lining unavailable; and
- Good probability of tampering by the public (i.e., removal of riprap or other measures).

As such, the first step in the design of a rigid lining is to determine the existence of any condition that may adversely affect the performance of the lining. Conditions to look for are:

- Unstable ground;
- Ground water seepage;
- Frost susceptible soil;
- Expansive clays; and
- Hydraulic uplift conditions.

The presence of any of the above will lead to distortions in the channel lining and eventual failure if the problem is not adequately addressed at the design stage. Such conditions may require the services of a hydrotechnical or geotechnical engineer during the design and construction phase.

When non-problematic ground conditions are present, the design is completed by estimating the design discharge and providing an adequate hydraulic section using the principals of open channel hydraulics presented earlier in this section.

The design discharge for permanent installations should correspond to the estimated runoff from an event with a return period of 1:10 years. A larger design event with a return period of 1:25 years or greater may be used in situations where it is judged that a safety hazard exists and that significant disruption of traffic will be caused by a structural failure of the installation.

F.16.1 Other Requirements

Rigid lining design requires considerations of upstream and downstream scour, hydrostatic uplift of the lining, anchorage to the slope and structural cracking. For small drainage areas less than 25 ha, the above requirements can be addressed by the following "rule-of-thumb" provisions:

- Utilize virgin ground or well-compacted fill for subgrade;
- Place a 150 mm thick drainage layer under the region of the downstream outlet;
- Provide a riprap apron with 150 mm diameter rock to a thickness of 225 mm for a length of 2 m;
- Provide cut-off walls at both the upstream and downstream end of the structure. Depth of cut-off should be 0.5 m across the entire width of the transition;
- Ensure structural thickness of the lining is a minimum of 75 mm; and
- Provide adequate freeboard.

F.17 Steep Gradient Channels

Steep gradient channels, defined herein as channels having gradients in excess of 10%, are sometimes required of the conveyance of water from an elevation to another at a significantly lower level. In cases of low flow conditions, a temporary lining will suffice to control any soil erosion until vegetation gets established. However, in situations of moderate flow, there will be the need for a permanent erosion control measure such as random riprap linings.

Permanent flexible linings (i.e., riprap lining) will be capable of handling most of the cases that cannot be resolved by vegetation. Rarely will a piped conduit (downdrain) or a rigid lining be required.

Materials commonly used for permanent flexible linings along steep gradients are riprap and gabions. Gabions include drop structures and mattresses. Hollow precast concrete blocks which interlock may sometimes be used if economy can be achieved. Generally, precast blocks tend to be more costly than riprap options.

For steep channels, drop structures are commonly used for flow control and energy dissipation.

F.17.1 Design Procedure

On steep channel bed slopes, temporary linings, which are usually of the blanket type, can be designed as outlined in Section F.15. Permanent rigid linings are to be designed according to Section F.16. In either case, there is a need to distinguish between a steep gradient and a gentle one.

With permanent flexible linings like riprap, gabion or concrete blocks, there are additional factors that must be taken into consideration when comparing the tractive stress of the design flow with the resistance of the lining. In none of the three types can a single permissible shear stress value be defined for steep gradient channels.

Physical factors to be considered are size and shape of the material comprising of the bed and sideslopes and channel geometry. Other factors are material buoyancy and the weight component down slope.

With proprietary concrete block systems (in which size, shape and surface roughness vary with each type of block), a generalized channel design procedure cannot be presented. Designs incorporating these materials must be completed according to the recommendations of the manufacturer.

However, with riprap and gabions, extensive hydraulic testing and theoretical evaluations have been carried out on material gradation normally used for such purposes and design procedures were evolved which are presented below. A comparison of the relative thickness of riprap versus gabion mattress was once investigated to indicate that a smaller (2 to 3 times) thickness of gabion mattress can be utilized under identical severe hydraulic conditions.

F.17.2 Riprap Design

Investigations into the use of riprap on steep slopes have led to rather complex equations which may not be of practical value in design. By making simplified assumptions regarding the typical gradation of riprap and by conducting hydraulic tests, charts given in Figures F.11 to F.14 have been produced from the complex formulation to simplify the design process. The charts can be used for bed slopes varying between 10% and 25% and bed width increasing from 0 to 1.5 m. Linear interpolation will be required for bed slope and bed width intermediate between the limits given on the charts. These procedures are illustrated in design examples presented in Appendix H as design examples H.10 and H.11.

Riprap used as a ditch lining on either gentle or steep grades needs to be sufficiently thick to ensure minimal loss of the underlying material. Additionally, a filter consisting of a suitably graded granular material or geosynthetic of appropriate weight is required under the riprap to prevent piping failure of the underlying material.

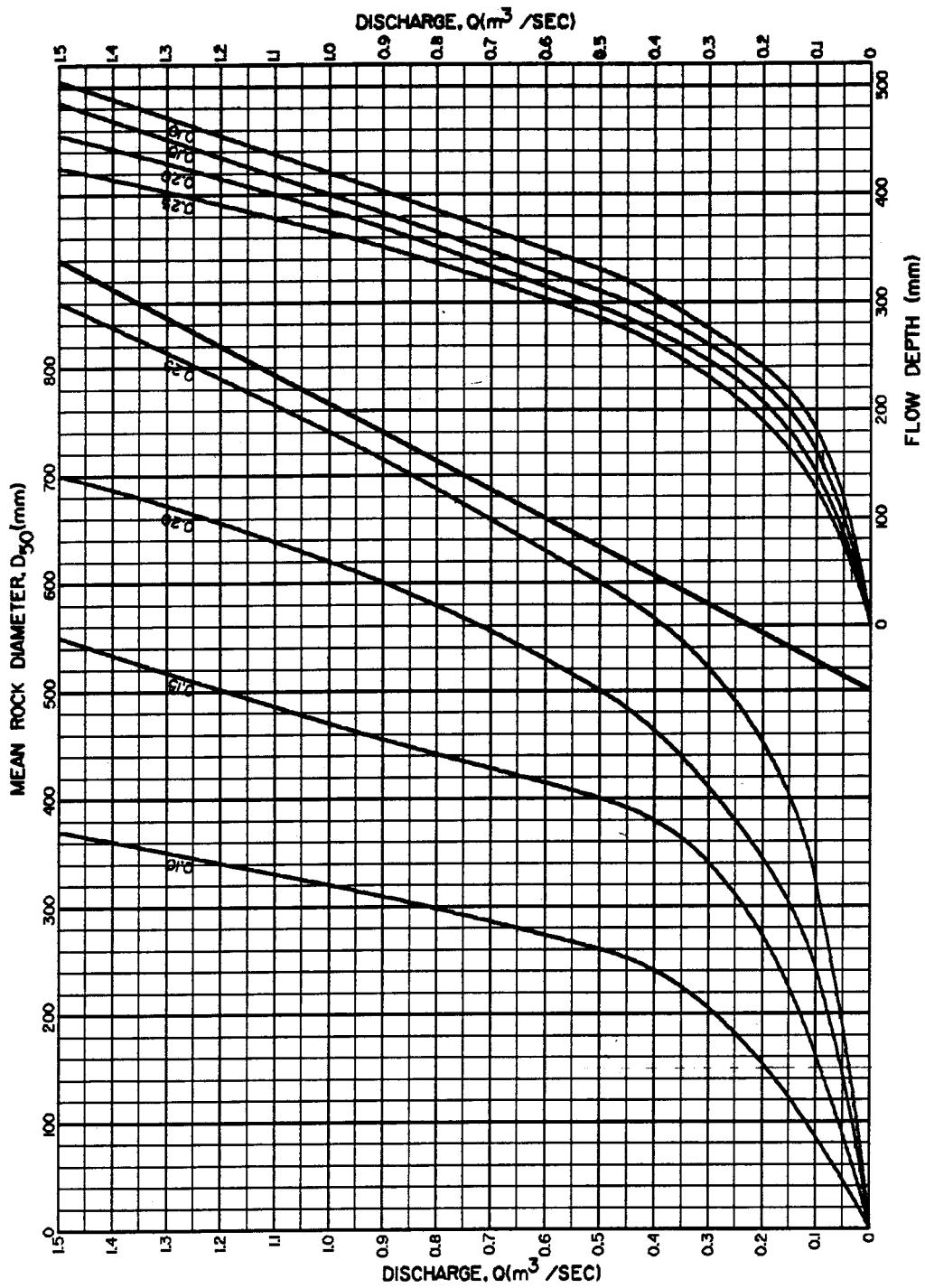

**Figure F.11: Steep Slope Riprap Design
(Bed Width = 0 m, Sideslope = 3:1*)**

Source: Chen & Cotton, 1988

* Typical slopes for a highway construction site in Alberta range from 3:1 to 6:1.

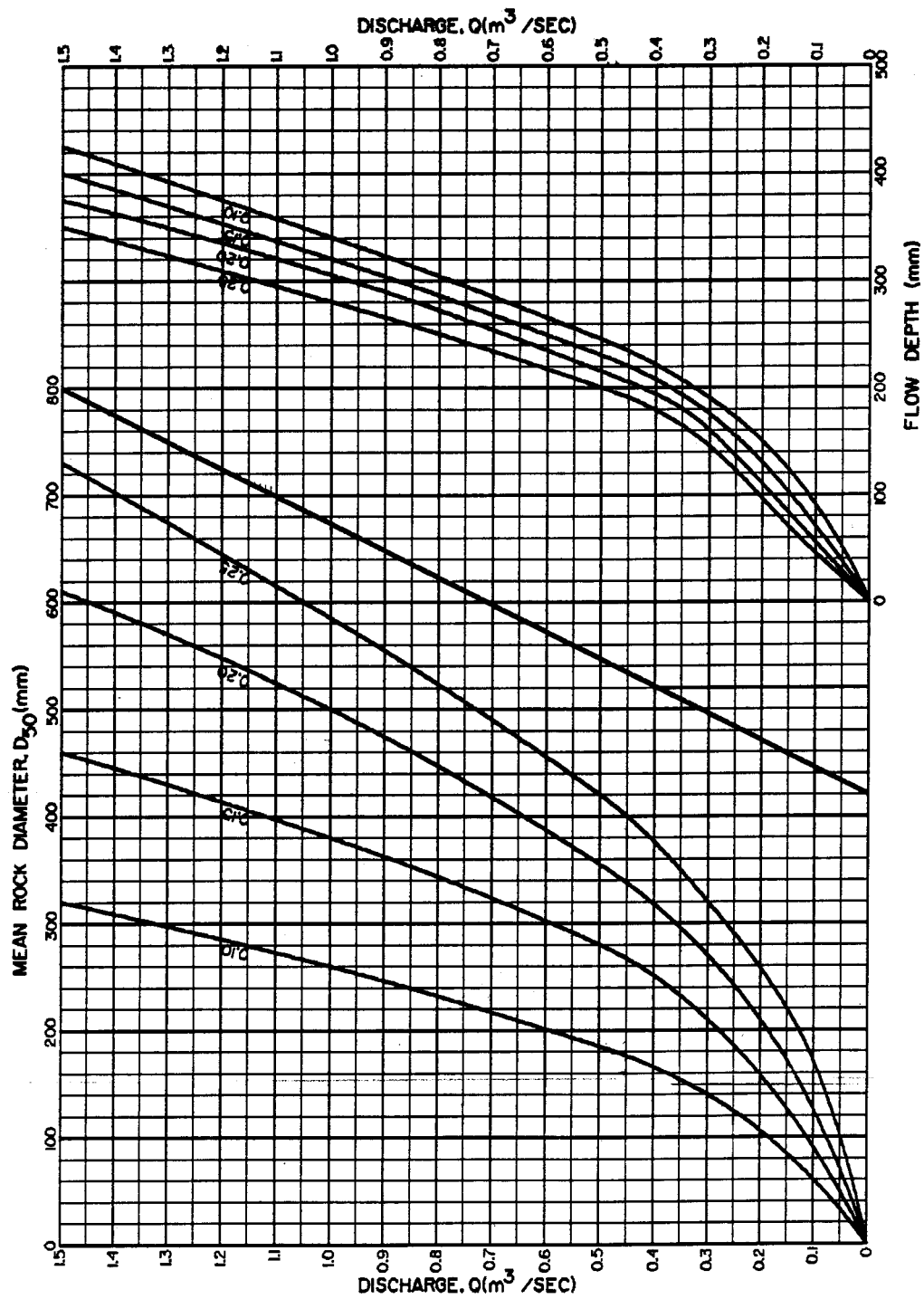

**Figure F.12: Step Slope Riprap Design
(Bed Width = 0.5 m, Sideslope = 3:1*)**

Source: Chen & Cotton, 1988

* Typical slopes for a highway construction site in Alberta range from 3:1 to 6:1.

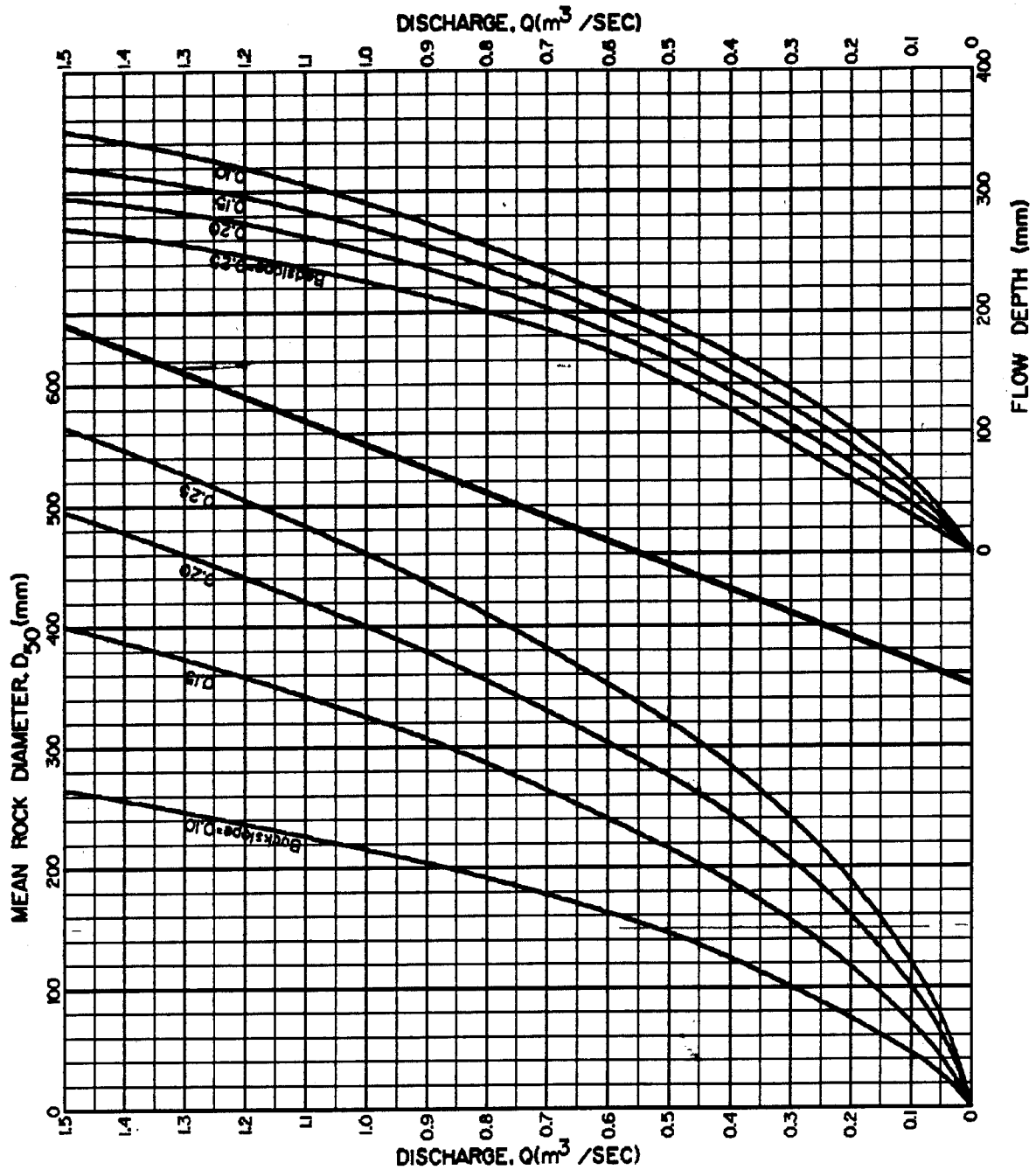

Figure F.13: Steep Slope Riprap Design
(Bed Width = 1.0 m, Sideslope = 3:1*)

Source: Chen & Cotton, 1988

* Typical slopes for a highway construction site in Alberta range from 3:1 to 6:1.

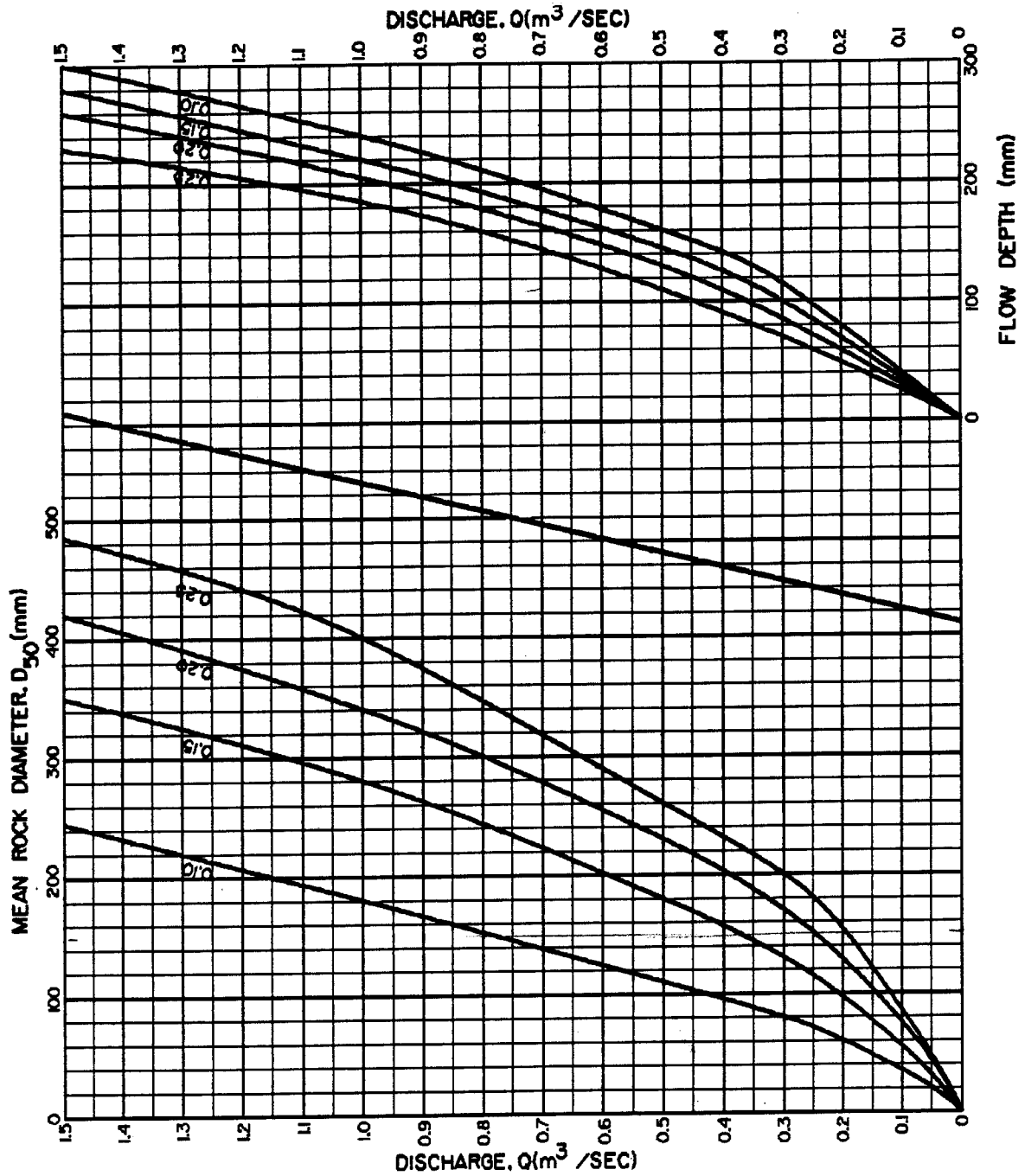

Figure F.14: Steep Slope Riprap Design
(Bed Width = 1.5 m, Sideslope = 3:1*)

Source: Chen & Cotton, 1988

* Typical slopes for a highway construction site in Alberta range from 3:1 to 6:1.

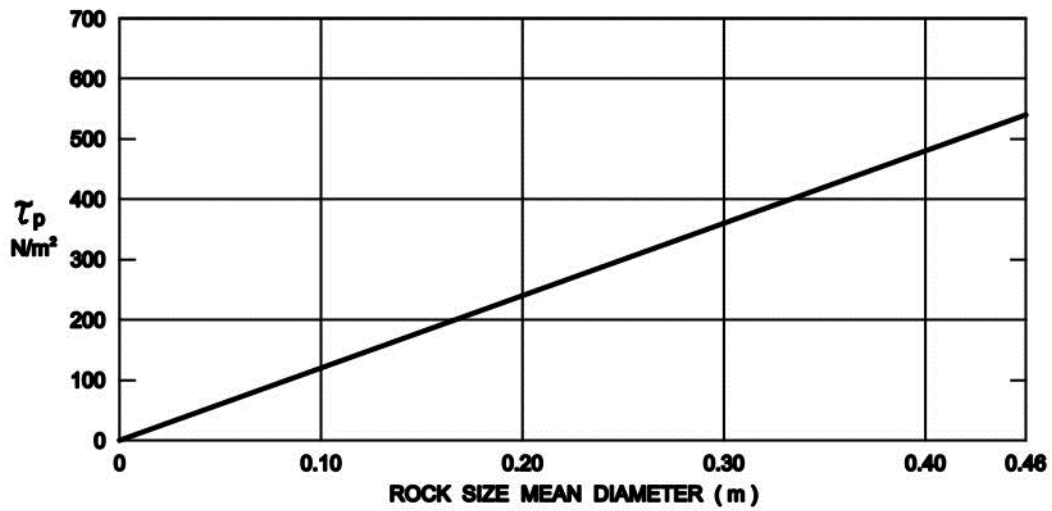

Figure F.15: Permissible Shear of Gabion Mattress vs. Rock Fill Size

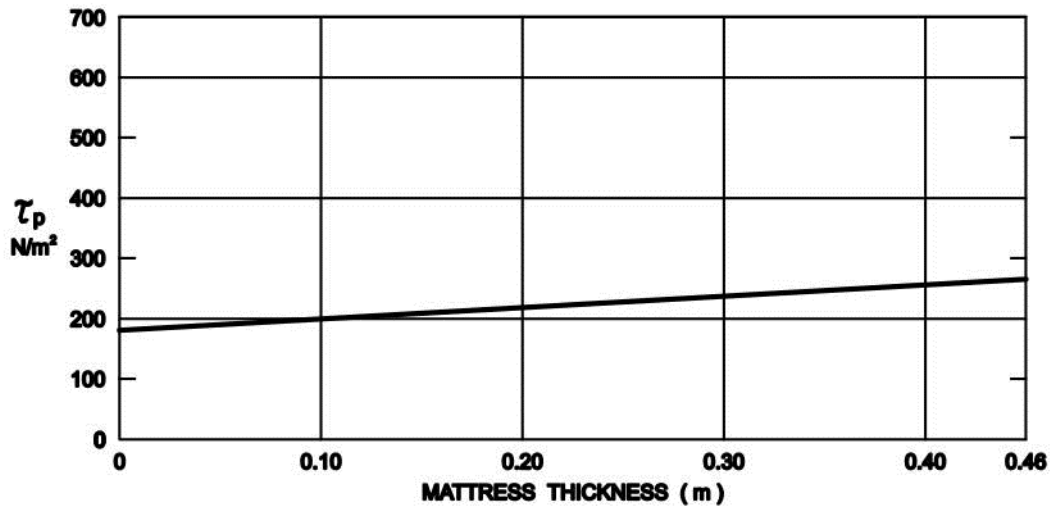

Figure F.16: Permissible Shear of Gabions vs. Mattress Thickness

Source: Chen & Cotton, 1988

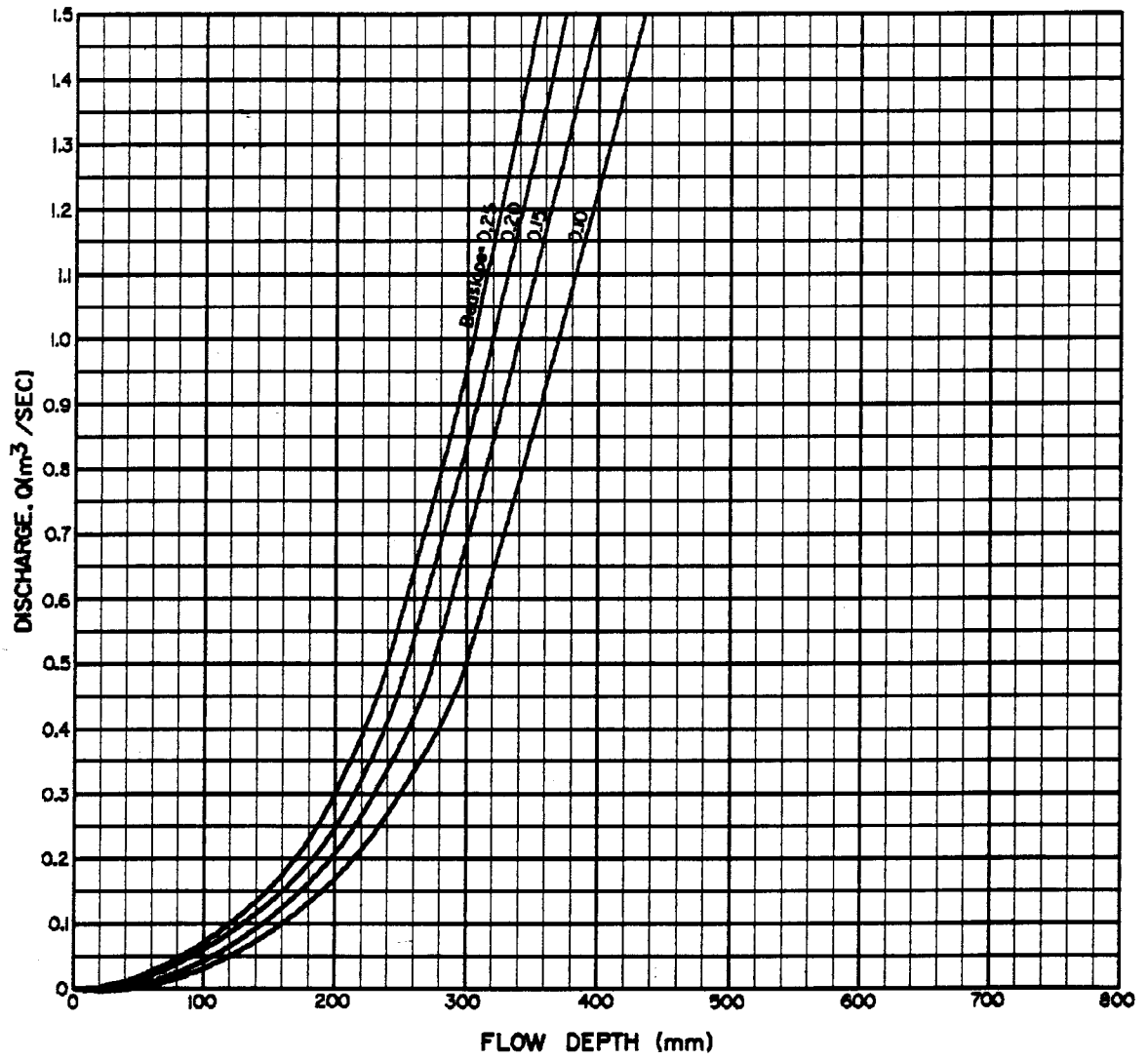

Figure F.17: Steep Slope Gabion Design
 (Bed Width = 0 m, Sideslope = 3:1*)

Source: Chen & Cotton, 1988

* Typical slopes for a highway construction site in Alberta range from 3:1 to 6:1.

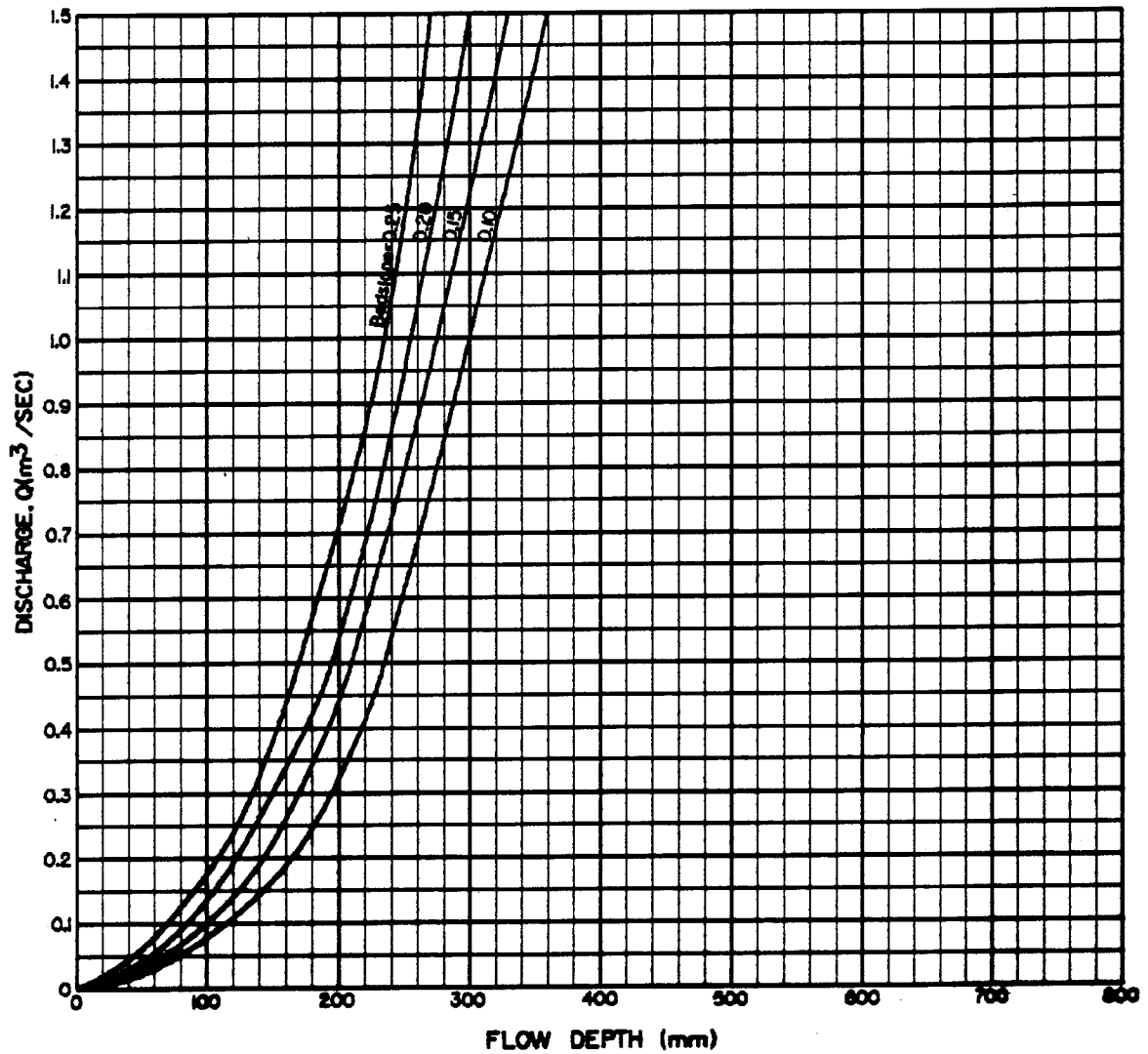
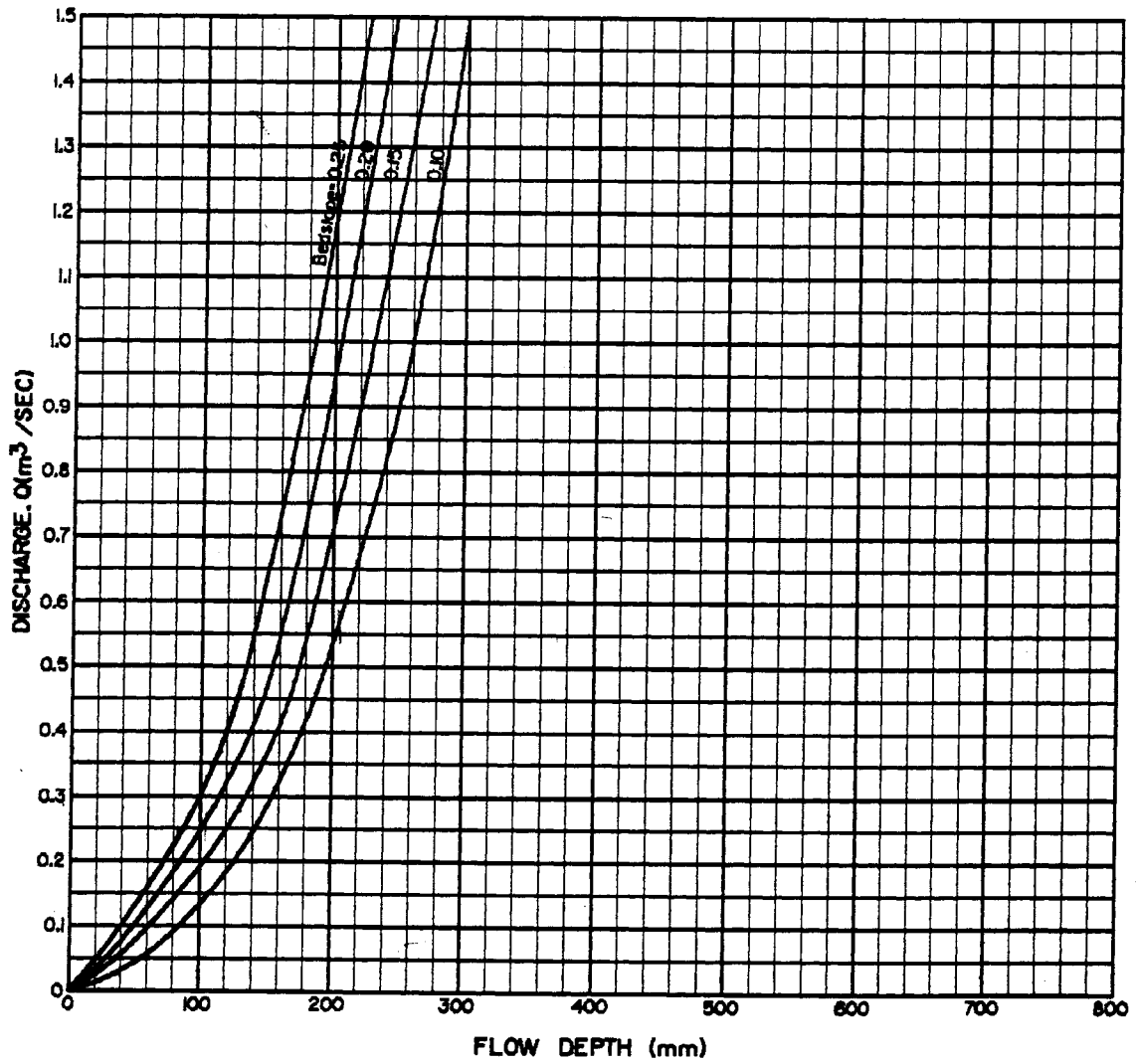

Figure F.18: Steep Slope Gabion Design
(Bed Width = 0.5 m, Sideslope = 3:1*)

Source: Chen & Cotton, 1988

* Typical slopes for a highway construction site in Alberta range from 3:1 to 6:1.



**Figure F.19: Steep Slope Gabion Design
(Bed Width = 1.0 m, Sideslope = 3:1*)**

Source: Chen & Cotton, 1988

* Typical slopes for a highway construction site in Alberta range from 3:1 to 6:1.

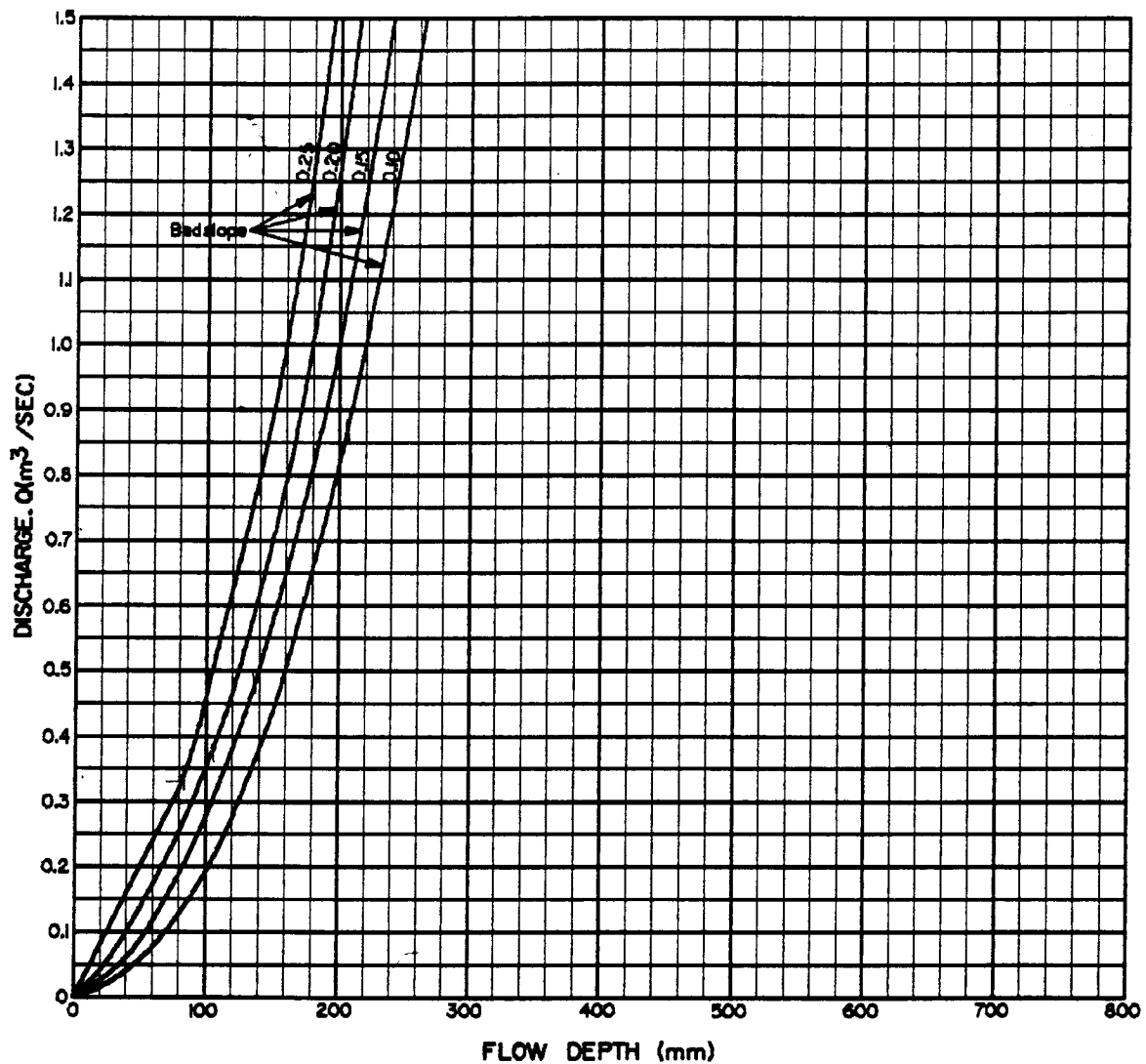

Figure F.20: Steep Slope Gabion Design
(Bed Width = 1.5 m, Sideslope = 3:1*)

Source: Chen & Cotton, 1988

* Typical slopes for a highway construction site in Alberta range from 3:1 to 6:1.

F.17.3 Gabion Design

Gabions are somewhat different from riprap in that the rocks are bound together by a wire mesh. Thus rocks rolling down slope are not considered to be a mode of failure. The gabion structures can accommodate higher discharges than an equivalent-sized riprap channel.

Gabions are commonly used as drop structures for flow control and energy dissipation. Changing the channel slope from steep to mild, by placing drop structures at intervals along the channel reach, changes a continuous steep slope into a series of gentle slopes and vertical drops. Instead of slowing down and transferring high erosion producing velocities into low non-erosive velocities, drop structures control the slope of the channel in such a way that the high, erosive velocities never develop. The kinetic energy or velocity gained by the water as it drops over the crest of each structure is dissipated by a specially designed apron or stilling basin which may be constructed of gabion mattress (FHWA HEC #14).

One probable failure mode though is the rearrangement of the rocks within the gabion structure through the shear action of flowing water. Another mode is the scouring of the material underneath and behind the gabions. Both failure modes must be addressed in design to ensure a functional structure. In this regard, charts given in Figures F.17 and F.18 have been prepared to guide both rock size selection and structure thickness evaluation.

The hydraulics of gabion structures has also been investigated (Chen & Cotton 1988). To assist in design, charts shown in Figures F.17 to F.20 have been prepared which relate discharge with depth of flow and bed slope. Bed widths considered are 0 to 1.5 m and bed slopes varying between 10 and 25% with sideslopes fixed at 3:1.

The charts can be extended to other channels with stable sideslopes by firstly designing an equivalent bed width channel with 3:1 sideslopes. The flow depth in the channel to be designed is then adjusted by equating flow areas. This procedure is presented in the design example presented in Appendix H as Example H.13.

Gabions used as ditch lining on either gentle or steep grades, need to be sufficiently thick to ensure minimal loss of the underlying material. Additionally, a filter consisting of suitably graded granular material or geosynthetic of appropriate weight is required under them to prevent piping failure of the underlying material.

F.17.4 Filter Material

Traditionally, a filter layer comprised of well-graded granular material is placed between the base soil and the riprap or gabion system. The intent is to ensure sufficient permeability to allow seepage to take place out of the underlying soil while at the same time minimizing the size of the voids in the filter to prevent the underlying material from migrating into the armour layer.

In current engineering practice, the granular filter blanket is largely replaced by a geotextile filter which performs essentially the same functions. Specific requirements for each type of filter area are:

Granular Filter:

$$(1) \quad \frac{D_{15}(\text{filter})}{D_{85}(\text{soil})} < 5 < \frac{D_{15}(\text{filter})}{D_{15}(\text{soil})} < 40 \quad (\text{Equation F.8})$$

$$(2) \quad \frac{D_{50}(\text{filter})}{D_{50}(\text{soil})} < 40 \quad (\text{U.S. Army Corps. of Engineers, 1955})$$

- (3) Filter thickness $\geq 1 \times D_{100}$ (filter) or 150 mm minimum thickness, whichever is greater.

Where:

D_{50} = particle size diameter (m/mm) corresponding to 50% passing by mass

Geotextile Filter:

In selecting an engineering filter fabric, the fabric should be able to transmit water from the soil and also have a pore structure that will hold back soil. The following properties of an engineering filter fabric are required to assure that their performance is adequate as a filter under riprap and gabion rock.

1. The fabric must be able to transmit water faster than the soil.
2. The following criteria for the apparent opening size (AOS) must be met:
 - a) For soil with less than 50 percent of the particles by weight passing a 0.075 mm opening (U.S. No. 200) sieve AOS < 0.6 mm (greater than U.S. No. 30 sieve).
 - b) For soil with more than 50 percent of the particles by weight passing a 0.075 mm opening (U.S. No. 200) sieve AOS < 0.297 mm (greater than U.S. No. 50 sieve).

The above criteria only apply to non-severe or non-critical installations. Severe or critical installations should be designed based on permeability and gradient ratio testing.

F.17.5 Lining Thickness

The minimum thickness of gabion or riprap structures should be the size of the largest stone to be used. Obviously, an isolated large stone which is not representative of the overall material should be discarded and not taken as a measure of the structure thickness. For most rocks used for ditch lining purposes, the criterion will translate into the following:

$$\text{Lining thickness} = (2 \text{ to } 3) \times D_{50} \quad (\text{Equation F.9})$$

F.17.6 Gradation

Both riprap and gabion stone should be uniformly graded meeting the requirements below:

$$3 > D_{100} / D_{50} > 1.5; \text{ and} \\ 3 > D_{50} / D_{20} > 1.5 \quad (\text{Equation F.10})$$

The criteria will allow some smaller rock sizes in the armouring which will fill the voids between the larger rocks to form a compact layer.

A further requirement, applicable only to gabion structures, is that the largest rock should not be less than $2/3$ of gabion thickness nor should the smallest rock be smaller than the mesh opening size.

F.18 Design Examples

Simple design examples using the tractive stress theory and permissible velocity theory have been worked out and are illustrated in design examples presented in Appendix H as H.8 to H.14.

APPENDIX G

**SEDIMENT CONTAINMENT SYSTEM
DESIGN RATIONALE**

THIS PAGE LEFT BLANK INTENTIONALLY.

FIGURES

| | |
|-------------|---|
| Figure G.1 | Estimated Runoff from Precipitation Over Different Soils |
| Figure G.2 | Time for Suspended Particles to Fall 1 cm in Water at 0°C (Stokes' Law) |
| Figure G.3a | Model of Drainage Outlet of Sediment Pond |
| Figure G.3b | Flow (Q) through an Outlet Barrier of Various Diameter (D) Rocks in Gabion Basket |
| Figure G.3c | Parameters and Porosity (ρ) of Rocks |
| Figure G.3d | Type I Sedimentation Pond Containment Structure (Sediment Basin Plan) |
| Figure G.3e | Type II Containment Structure (Sediment Trap Plan) |
| Figure G.3f | Simplified Sections of Dyke / Outlet |
| Figure G.4 | Typical Sedimentation Basin/Trap Outlet Permeable Structure with Rock Filter Barrier and Perforated Pipe |
| Figure G.5 | Hydrometer Gradation Curve to Determine PEG |
| Figure G.6 | Concept of Sedimentation Apparent Efficiency (A_{eff}) for Suspended Particles in Zones of Uniform and Turbulent Flows at Permeable Berm of a Containment System Outlet |
| Figure G.7 | Apparent Effectiveness (A_{eff}) of a Sediment Containment System |

TABLES

| | |
|-----------|--|
| Table G.1 | Settling Velocities (V_s) for Suspended particles (Specific Gravity = 2.65) in Water at Different Temperatures, as calculated by Stokes' Law |
|-----------|--|

G.1 Sediment Containment System Design Rationale

The following design rationale is considered reasonable to evaluate the effectiveness of containment system (Type I and II) for use at high to medium risk areas.

- An inflow quantity (Q_i) is assessed based on runoff volume (Q) from a 24-hour intensity rainfall, a 1:2 year storm. (Runoff from a 1:10 year storm will be approximately 2.5 times that for a 1:2 year storm. Thus, it is impractical to provide such large storage volume, especially if revegetation of disturbed area is to be achieved in 1-2 years and deactivation of the basin/trap considered for rural highways.)
- A sediment delivery ratio (SDR ranges from 0 to 1) is a subjective parameter
- $SDR = 1$; when a high risk area is at immediate connectivity downslope of an erosion source

Runoff (Q) and Inflow (Q_i) Estimation (1:2 yr. storm, 24hr intensity rainfall, soil type, area of disturbance)

$$Q_i = SDR \times Q \quad \text{(Equation G.1)}$$

Where: Q_i = Inflow to sedimentation pond (m^3/s)
SDR = Sediment delivery ratio (dimensionless)
 Q = Natural runoff (m^3/sec)

Runoff is estimated using:

- Precipitation of a 24 hour rainfall intensity from a 1:2 year storm;
- Effect of ground absorbency of different soil types affecting runoff. For various soil types, a general relationship between precipitation and runoff per hectare can be assessed. (see Figure G.1);
- Some jurisdictions (such as EPA) assume 25 mm runoff as minimum parameter;
- 150-250 m^3/ha of disturbed land;
- Amount of fine sediment laden runoff close to high risks: $SDR=1$

The quantity of runoff from precipitation is affected by the absorbance, permeability and texture of the surficial soils (Figure G.1).

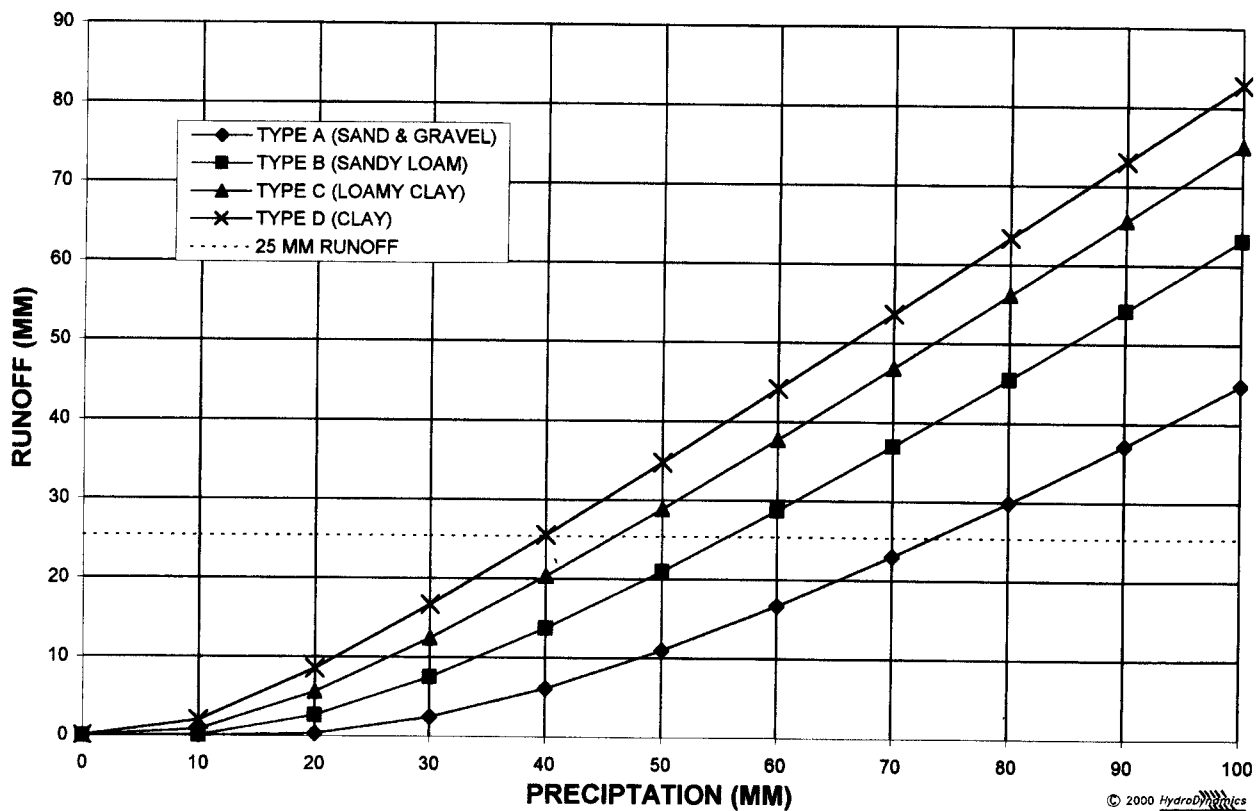

Figure G.1: Estimated Runoff from Precipitation over Different Soils

Source: Fifield, 2001

Settling Velocity (V_s) for Soil Particles

A particular soil particle size (D_s) can be targeted within the sediment laden runoff and its percentage by weight is determined from a hydrometer gradation curve of local soil materials. Different size particles exhibit different settling velocities with smaller particles requiring a longer time to settle. The different settling velocities for sand to silt to clay size particles are presented in Table G.1. The times required for the clay to sand size particles to settle in vertical distances in water are presented in Figure G.2 and it shows that clay size particles require a very long settling time.

The introduction and use of approved coagulants, such as polyacrylamide (PAM), causes the coagulation of small clay particles into larger particles thereby increasing their settling velocity and effectively reducing the settling time for small particle-sized soil.

The settling velocity (V_s) is assessed for a target soil particle size

$$V_s \propto D_s \text{ (Stokes' Law)}$$

Where:

D_s = Diameter of a target particles size (cm)

Stokes' Law

$$V_s = g \times (S - 1) \times d^2 / (18 \times \mu) \quad (\text{Equation G.2})$$

- Where: V_s = Settling velocity (cm/sec)
 g = Acceleration of gravity (981 cm/s²)
 μ = Kinematic viscosity of a fluid (cm²/s²)
 S = Specific gravity of a particle
 d = Diameter of a particle (cm) (assuming a sphere)

Table G.1: Settling Velocities (V_s) for Suspended Particles (Specific Gravity = 2.65) in Water at Different Temperatures, as Calculated by Stokes' Law

| Diameter (mm) | Settling Velocity in Centimetres per Second | | | | | Particle |
|------------------|---|-------|-------|-------|-------|----------------|
| | 0°C | 5°C | 10°C | 15°C | 20°C | |
| 0.01 | 0.005 | 0.006 | 0.007 | 0.008 | 0.009 | Fine Silt |
| 0.02 | 0.020 | 0.023 | 0.027 | 0.031 | 0.035 | Medium Silt |
| 0.03 | 0.044 | 0.052 | 0.060 | 0.069 | 0.078 | |
| 0.04 | 0.078 | 0.092 | 0.107 | 0.122 | 0.139 | Coarse Silt |
| 0.05 | 0.122 | 0.143 | 0.167 | 0.191 | 0.217 | |
| 0.06 | 0.176 | 0.207 | 0.240 | 0.275 | 0.313 | |
| 0.07 | 0.239 | 0.281 | 0.327 | 0.375 | 0.426 | Very Fine Sand |
| 0.08 | 0.312 | 0.367 | 0.427 | 0.490 | 0.556 | |
| 0.09 | 0.395 | 0.465 | 0.540 | 0.620 | 0.704 | |
| 0.11 | 0.488 | 0.574 | 0.667 | 0.765 | 0.869 | |
| 0.11 | 0.590 | 0.694 | 0.807 | 0.926 | 1.051 | |
| 0.12 | 0.703 | 0.826 | 0.960 | 1.101 | 1.251 | |
| 0.13 | 0.825 | 0.970 | 1.127 | 1.293 | 1.468 | Fine Sand |
| 0.14 | 0.956 | 1.125 | 1.307 | 1.499 | 1.703 | |
| 0.15 | 1.098 | 1.291 | 1.501 | 1.721 | 1.955 | |
| 0.16 | 1.249 | 1.469 | 1.707 | 1.958 | 2.224 | |
| 0.17 | 1.410 | 1.658 | 1.928 | 2.211 | 2.511 | |
| 0.18 | 1.581 | 1.859 | 2.161 | 2.478 | 2.815 | |
| 0.19 | 1.761 | 2.072 | 2.408 | 2.761 | 3.136 | |
| 0.20 | 1.952 | 2.295 | 2.668 | 3.060 | 3.475 | |
| | 32°F | 41°F | 50°F | 59°F | 68°F | |

Source: Fifield, 2001

Commonly Used Conversion Factors

- 1.0 cm/sec. = 0.0328 ft/s or 0.3937 in/s
- 1.0 m = 3.281 ft or 39.37 in
- 1.0 in. = 2.54 cm = 25.4 mm
- 1.0 ha = 2.471 ac = 107,637 ft² = 10,000 m²
- 1.0 m³ = 35.3 ft³
- °C = 5/9(°F - 32°)

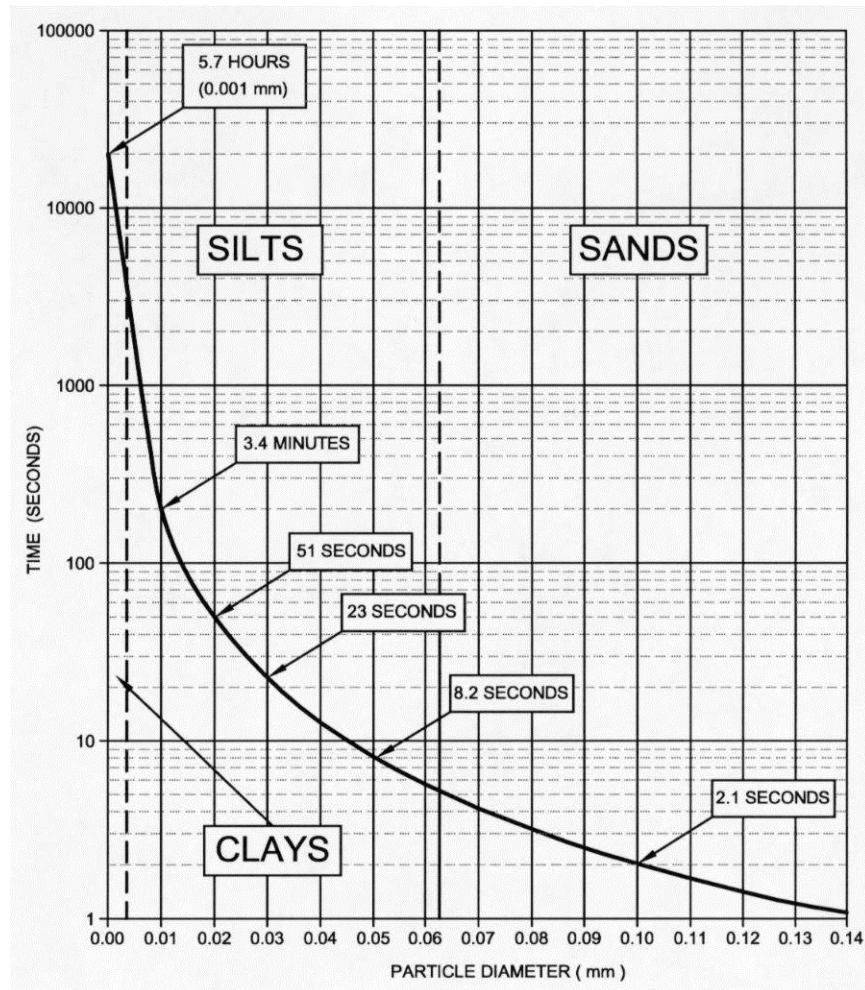

Figure G.2: Time for Suspended Particles to Fall 1 cm in Water at 0°C (Stokes Law)

Source: Fifield, 2001

From Figure G.2, the smaller diameter (D_s) soil particle (such as fine silt and clay) yields a very slow settling velocity (V_s), thus rendering a low efficiency system to settle very fine size clay particles.

The efficiency of a containment system is proportional to the settling velocity (V_s) and the particle size (D_s).

Outflow capacity (Q_o) of the containment system can be designed, based on free-draining properties of an outflow system which normally functions through a seepage or filter drainage outlet of the containment system. The outflow capacity is designed equal to or smaller than the inflow volume. It functions in a pond size configuration to provide sufficient flow path and containment time to effect sedimentation of a target size particle. During the time of containment, the target size particle will have sufficient detention time to settle to the bottom of the pond system. Generally, the outflow design of these systems is a free drainage granular berm, or a combination of perforated pipes, or a riser system functioning as filter/seepage structures and the size/configuration of the system will allow sufficient settling time for sediments to collect within the containment system. An example of the containment systems (Type I and II) is presented in Figures G.3d, G.3e and G.3f , as discussed below.

The general criteria for the selection and functioning of a containment pond system are presented in Section 12.2. The selection is dependent on the size of disturbed land, amount of runoff into the pond (Q_i) and target particle size (D_s) for settlement in order that an assessment of pond size/surface area (SA) can be estimated. The outflow capacity (Q_o) of the pond outlet is a function of structural and permeability design.

Generally, the runoff inflow (Q_i) is determined by a hydraulic or hydrotechnical professional or engineer. For the efficient settling operation of a pond, the inflow (Q_i) is equal to or less than the outflow (Q_o) to allow for sufficient settlement time for a low lateral flow passage within the pond chambers. Therefore, the rationale of settlement pond design assumes inflow (Q_i) equals outflow (Q_o).

$$Q_o=Q_i \qquad \text{(Equation G.3)}$$

Where:

Q_o = Outflow capacity of containment system

Q_i = Inflow

Outflow System

Two options of an outflow system: (1) Riser Outlet Option; (2) Permeable Rock Berm Outlet Option. They are discussed below:

Riser Outlet Option

A riser outlet is a circular overflow spillway that is connected to a culvert that passes through the containment berm. The riser pipe is fabricated from corrugated steel pipe conforming to CSA Standard CAN 5-G401-M81. The outlet pipe passing through the containment berm consists of a horizontal pipe welded to a 45° elbow (mitre joint) connecting to the riser pipe. The riser outlet system is equipped with a trash rack to minimize debris blockage.

100 mm diameter drainage holes are cut in the base of the riser pipe to form a perforated section near the elbow. A steel mesh is tack welded over it to form a screen. The portion of the riser pipe and elbow with the 100 mm diameter drainage holes and

mesh is to be backfilled with gravel. The size of the mesh covering the 100 mm diameter holes should be fine enough to filter granular material but coarse enough not to impede flow. Similar 100 mm diameter drainage holes can be provided along the riser pipe immediately above the elevation of the projected maximum sediment level.

The design of a riser pipe outlet can be completed by a hydrotechnical engineer to ensure the system has adequate capacity to discharge design flows without the risk of overtopping. Furthermore, a geotechnical engineer should design the culvert passing through the containment berm if the risk consequences of berm failure are significant.

Overflow Section System

An overflow section in the sediment containment system is not recommended as the primary means of discharging water due to concern of erosion of the containment berms. However, an overflow section is considered appropriate as an auxiliary outflow system for use in the event that the primary permeable rock outlet system (described in the following paragraph) should become blocked. Erosion protection at the outlet and on the berm slope is to be designed by an engineer. The overflow section is to be dimensioned at a minimum width of 1.5 m per 250 m² of pond area.

Permeable Rock Berm Outlet Option

One type of granular berm system is considered appropriate for use to allow seepage flow to exit from a sediment containment system. The following relationship (Jiang et al., 1998) can be used. The seepage outflow through drainage rock (25 mm to 100 mm diameters) in a gabion basket is modeled and can be applied to a granular berm outlet of a sedimentation pond/trap as illustrated in Figure G.3a and G.3b. The parameters and porosity of drainage rocks are shown in Figure G.3c.

$$Q_o = 0.327 e^{1.5S} (g D_{50} / T)^{0.5} \rho W H^{1.5} \quad (\text{Equation G.4})$$

(Jiang et al, 1998)

Where: Q_o = Outflow capacity of containment system (m³/s)

g = Acceleration due to gravity = 9.8m/s²

D_{50} = Mean diameter of the rock (m)

W = Total width of the barrier (m)

ρ = Porosity of the rock barrier

T = Thickness of the barrier (m)

H = Hydraulic head (m)

s = Slope of channel (%) (generally varies from 0% to 7% for highway gradeline profiles)

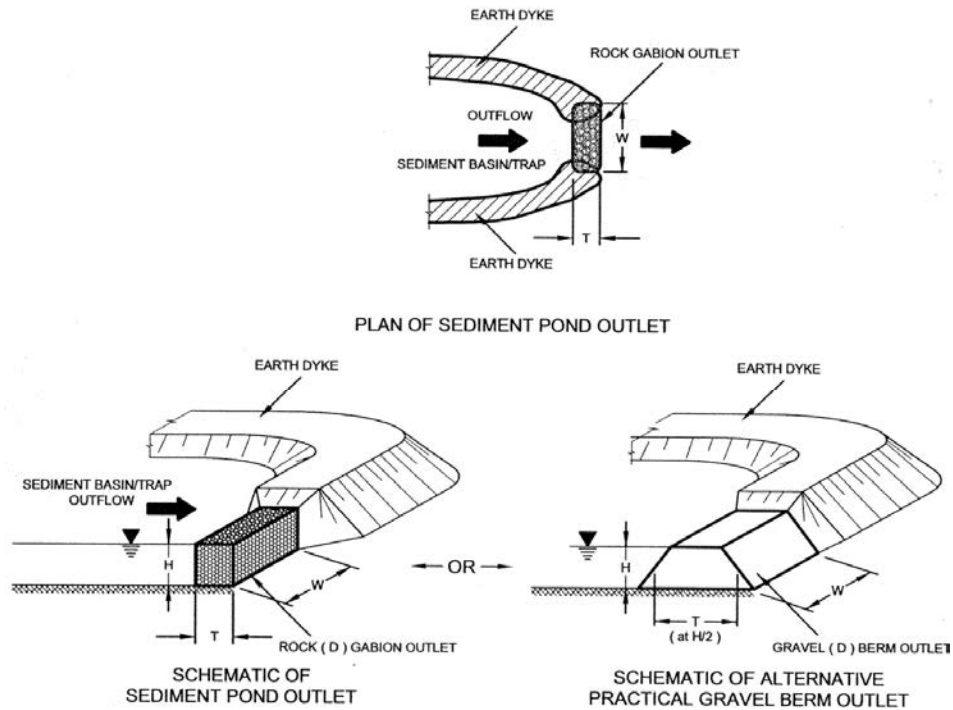

Figure G.3a: Model of Drainage Outlet of Sediment Pond

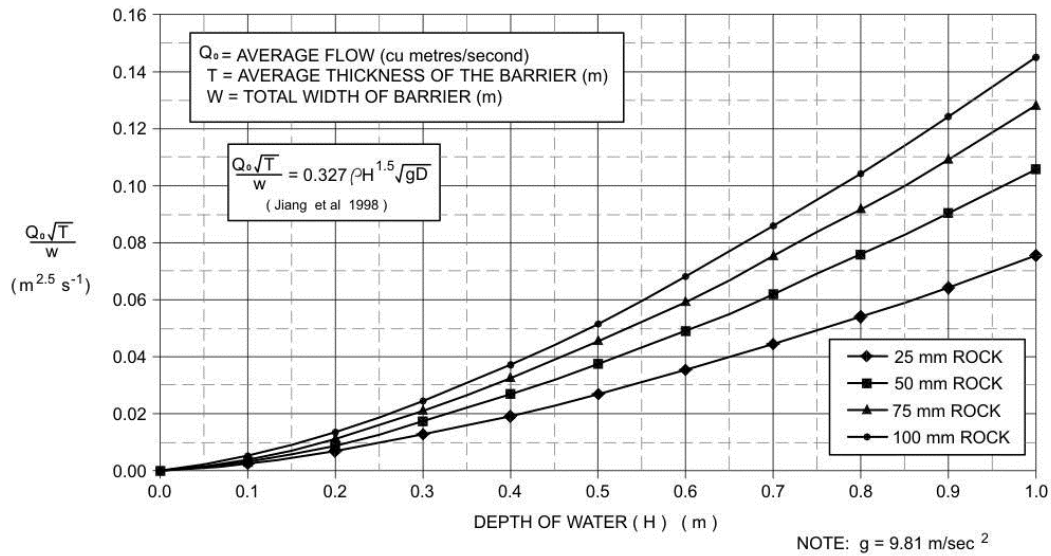
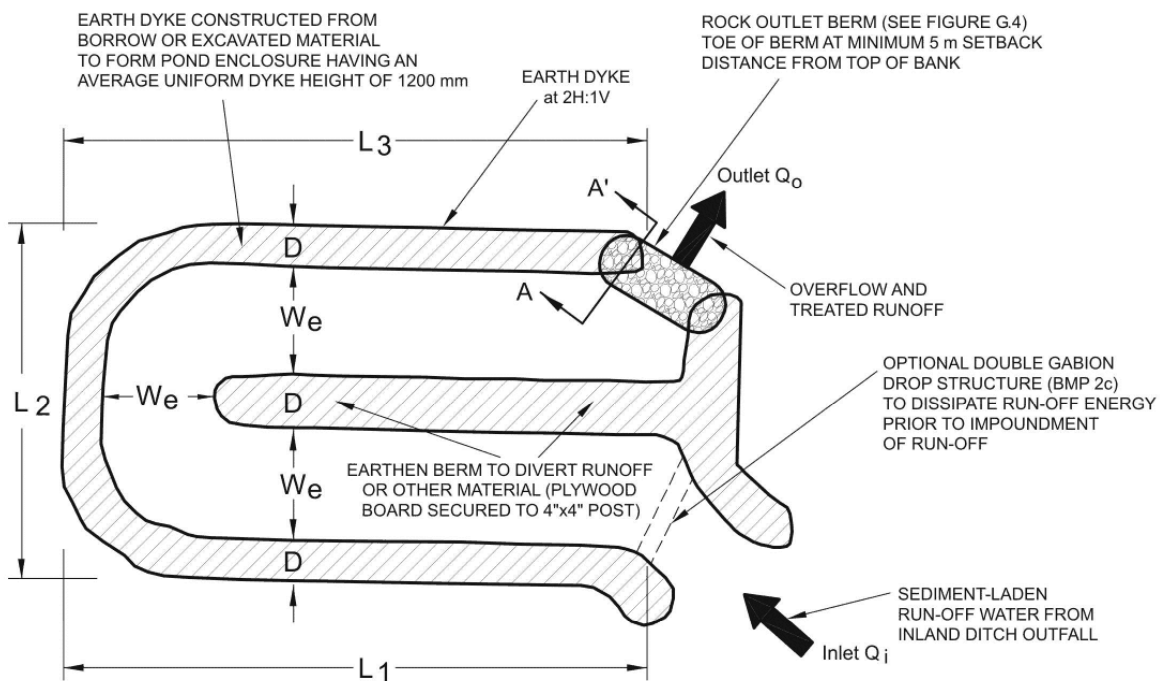

Figure G.3b: Flow (Q) Through an Outlet Barrier of Various Diameter (D) Rocks in Gabion Basket

Source: Fifield, 2001

| Mean Diameter (D) (mm) | Rock Density (kg/m ³) | Bulk Density (kg/m ²) | Porosity of Rock Fill (ρ) |
|-------------------------------|---------------------------------------|---------------------------------------|-------------------------------------|
| 25 | 2648 | 1593 | 0.398 |
| 43 - 50 | 2675 | 1446 | 0.459 |
| 75 - 88 | 2657 | 1461 | 0.450 |
| 100 | N/A | N/A | N/A |

(Source: Jiang et al 1998)

Figure G.3c: Parameters and Porosity (ρ) of Rocks

NOTES:

- CONTRIBUTING RUNOFF AREA CAN BE LARGER THAN 2.0 ha BUT LESS THAN 40.0 ha.
- EFFECTIVENESS APPROPRIATE FOR REMOVING MEDIUM TO COARSE SILT PARTICLES SUSPENDED IN RUNOFF.
- FLOW PATH $L = L_1 + L_2 + L_3$; FLOW WIDTH $W_e = 6$ m MINIMUM
- PROVIDE 1 TO 2 m (1 TO 2% GRADE) ELEVATION DROP BETWEEN INLET AND OUTLET GRADES.
- SHAPE OF POND TO CONFORM TO LAND WITH OUTLET AT MINIMUM 5 m SETBACK FROM TOP OF BANK.
- CONSTRUCTION TO ENSURE SWALES AND BAFFLES ARE TO CHANNEL WATER INTO THE PROPOSED SEDIMENT PONDS.

Figure G.3d: Type I Sedimentation Pond Containment Structure (Sediment Basin Plan)

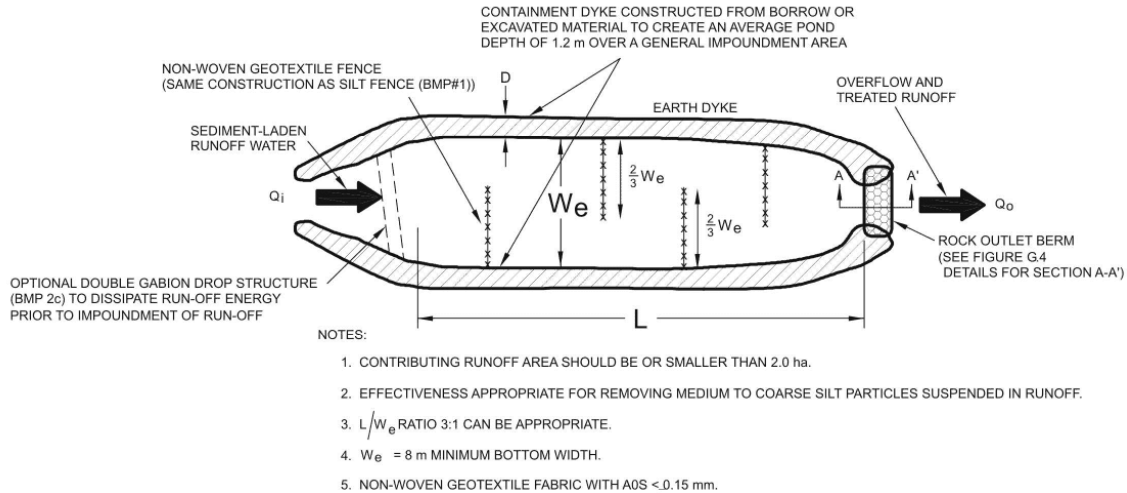

Figure G3.e: Type II Containment Structure (Sediment Trap Plan)

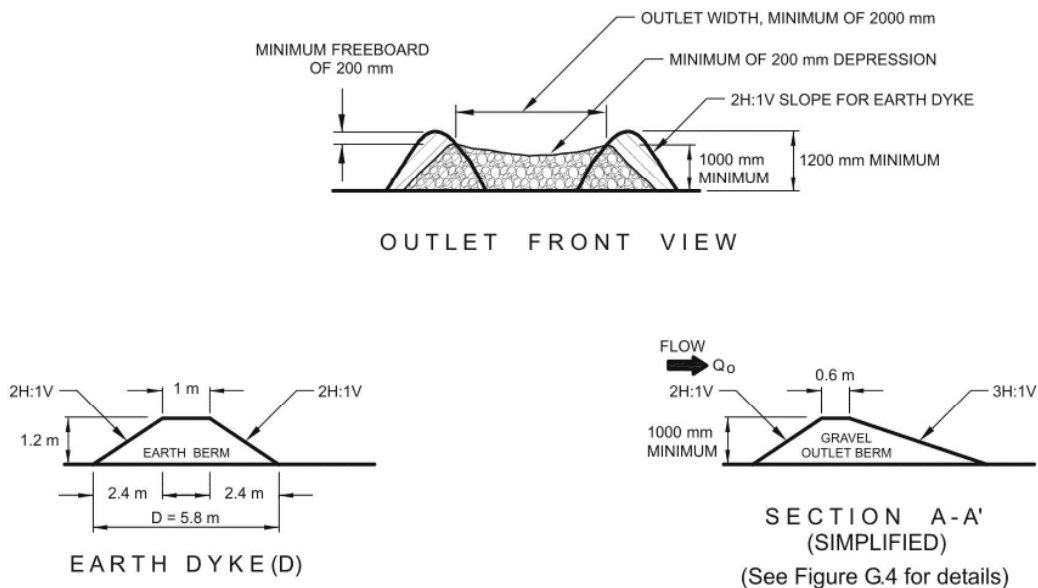

Figure G.3f: Simplified Sections of Dyke/Outlet

Source: Fifield, 2001

The outflow filter capacity of a rock barrier appears not sensitive to channel slopes varying from 0 to 6% (Jiang et al., 1998). The equation (Jiang et al., 1998) can be used for rock checks along channel with properly sized rocks for appropriate flow velocity (a nominal gradation can be: top size 250 mm, average size 150 mm, and bottom size 25 mm diameter) to provide stability to flow impact. A typical permeable outlet structure

(with rock filter and perforated pipe) for sediment basin/trap is presented in Figure G.4 for practical highway constructions.

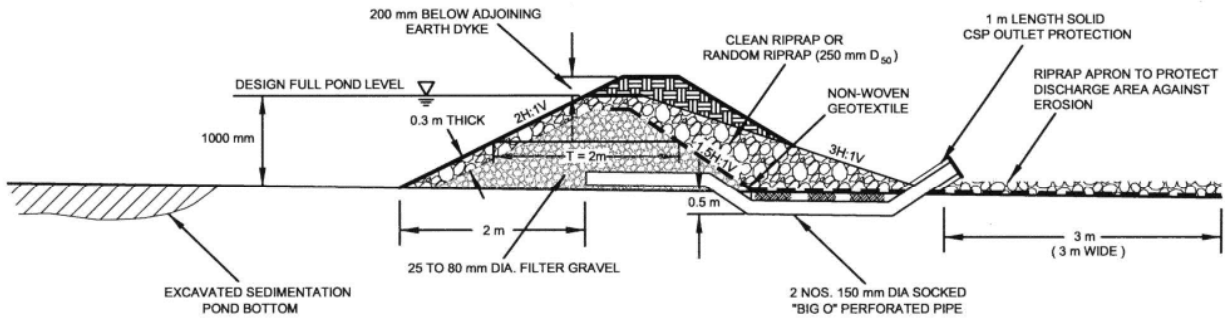

Figure G.4: Typical Sedimentation Basin/Trap Outlet Permeable Structure with Rock Filter Barrier and Perforated Pipe

Pond Area

The pond area (SA) size is based on the outflow capacity (Q_o) of the outlet structure (Figure G.3d and G.3e) and the settling velocity (V_s) of a target size particle. The outflow capacity (Q_o) is designed based on the runoff inflow quantity (Q_i) (Equation G.3).

$$SA = 1.2 Q_o / V_s \quad (\text{Equation G.5})$$

Where:

- SA = Pond area (m^2)
- Q_o = Outflow capacity for an outflow structure (m^3/s)
- V_s = Settling velocity of a target particle size (m/s)
- 1.2 = 20% extra capacity allowed for pond size

Pond Configuration

The size and configuration of a containment system is designed to provide sufficient volume and flow path to allow the target soil particles within the sediment laden runoff to settle during the time of impoundment.

Pond configuration entails length (L) and width (We) can be evaluated from pond area (SA).

$$L = SA / We \quad (\text{Equation G.6})$$

Multiply both sides by L, $L^2 = (SA \times (L / We))$

$$L = (SA \times (L / We))^{0.5} \quad \text{(Equation G.7)}$$

Where:

We = Width of Pond Chamber (m)

L = Length of Pond Chamber (m)

SA = Surface Area of Settling Pond (m²)

L/We = 10 is recommended for 100% apparent efficiency (A_{eff}) to minimize short-circuiting and maximize settling area (Goldman 1986). However, the exact behaviour of L/We in determining 100% A_{eff} can be subjective. The limitation of space does not normally allow a large size pond to be constructed to an L/We ratio of 10. The following pragmatic L/We ratios can be considered appropriate for the following structures:

| Containment Structure | L/We |
|-------------------------|------|
| Sediment Basin (Type I) | 8 |
| Sediment Trap (Type II) | 3 |

Pond Efficiency

The net efficiency (N_{eff}) of the containment system can be assessed based on model suggested by Fifield (Fifield 2001) utilizing the following concepts.

A_{eff} (%): Apparent Efficiency

PEG (%): Particle Size Equal to and Greater than a target size soil particle of a substrate soil (Reverse presentation of hydrometer gradation curve)

A_{eff} is modeled on pond dimensions (Fifield 2001) and the L/We ratios are postulated (Goldman, 1986). The dimensions of a pond to be designed are compared to dimensions of a model pond where 100% A_{eff} can be achieved for a target soil particle size.

PEG is a form of presentation of the gradation curve (hydrometer results of the fines portion) of an erodible substrate soil showing the percentage of coarser particles (Figure G.5) in the runoff that can be settled out in comparison to a target size soil particle (e.g., medium silt of 0.04 mm diameter). The soil tested for sedimentation PEG is usually taken from erodible soil sources of cutslope or borrow material used as fills on highway projects.

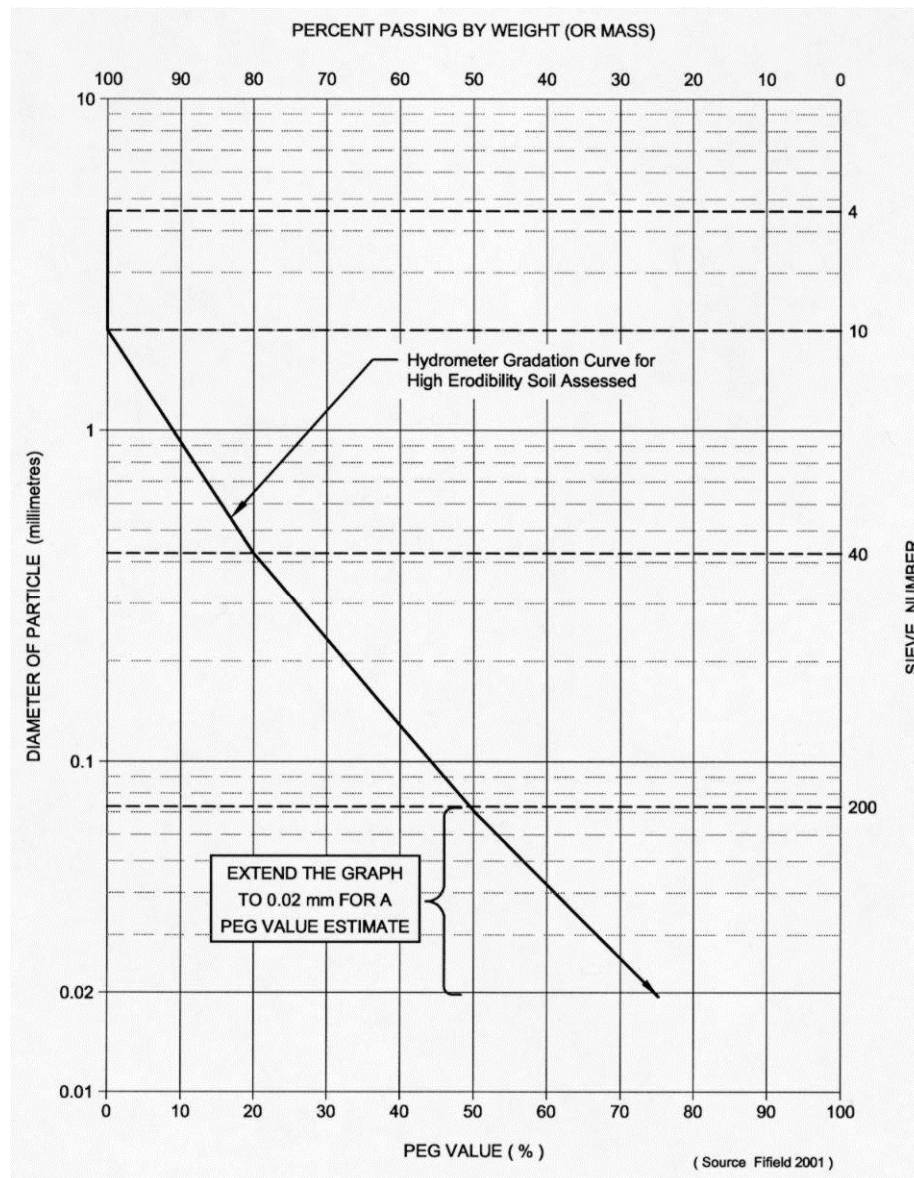

Figure G.5: Hydrometer (Particle Size) Gradation Curve to Determine PEG

Source: Fifield, 2001

Apparent Efficiency (A_{eff}) is modeled from the ratio of a 2-dimensional (length and height of flow area) design pond (A_c) to a model pond (A_{tc}) with an idealized design outfall capacity. A proportionality factor (K) of 0 to 1 is proposed for the ratio of realistic pond area of sediment capture to the model pond area (A_{tc}) of sediment capture. Within the containment pond, the flow path (L) is sized utilizing a lateral flow velocity (V_a) and a vertical settling velocity (V_s) of a target size soil particle allowing sufficient time for the particle to settle within the containment system (Fifield 2001). An illustration of the Apparent Efficiency (A_{eff}) model is presented in Figure G.6. The vertical distance of settlement is suggested by some investigators at 0.67 m for minimum height for a pond dyke. However, for design purposes with a factor of safety of 1.8, it is prudent to use 1.2 m for pond dyke to provide an extra freeboard of 0.2 m above the outlet permeable berm.

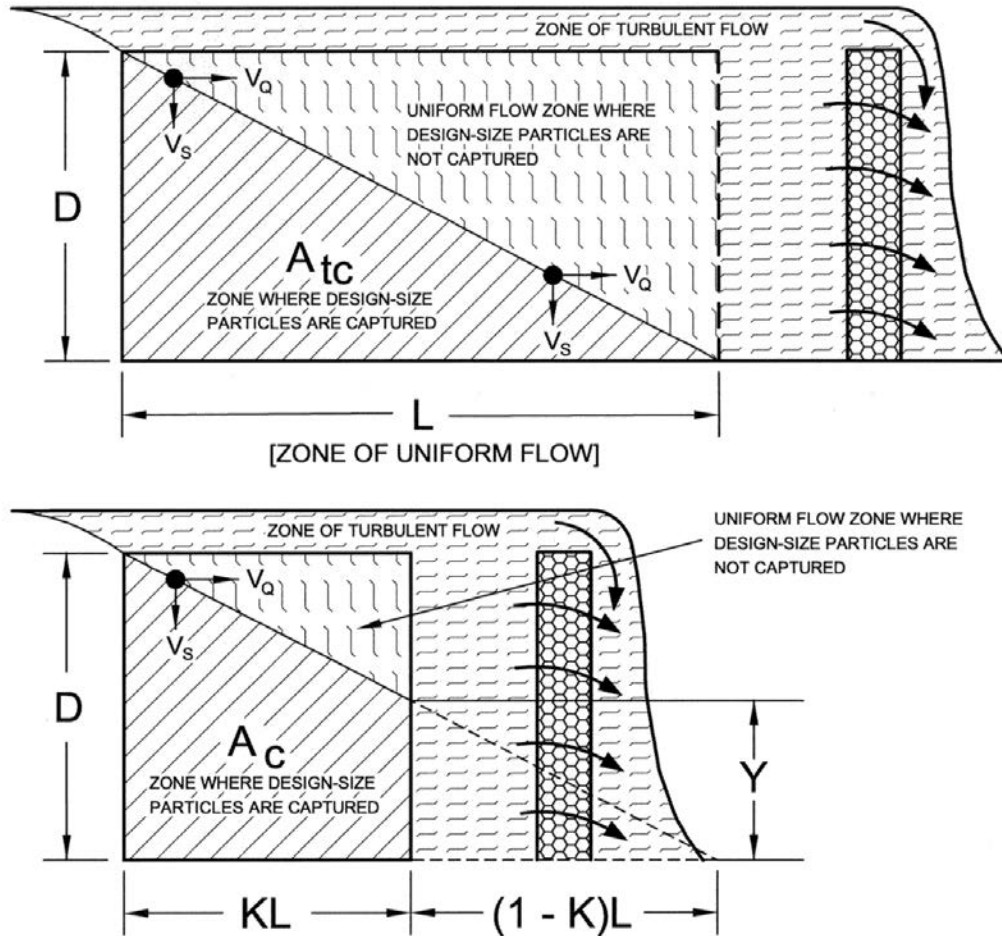

Figure G.6: Concept of Sedimentation Apparent Efficiency (A_{eff}) for Suspended Particles in Zones of Uniform and Turbulent Flows at Permeable Berm of a Containment System Outlet

Source: Fifield, 2001

$$A_{eff} = (A_c / A_{tc}) \times 100 \quad \text{(Equation G.8)}$$

$$A_{eff} = (2K - K^2) \quad \text{(Equation G.9)}$$

$$K = 0.1 (L / We) \quad \text{(Equation G.10)}$$

$$N_{eff} = A_{eff} \times PEG \quad \text{(Equation G.11)}$$

- Where:
- D = particle fall distance
 - A_{eff} = Apparent Efficiency (%)
 - K = A factor of 0.1 to 1, based on L/We ratio of 0 to 10 (10 is 100% A_{eff})
 - N_{eff} = Net Efficiency (%)

PEG = % of Particles Equal to and Greater than a target size particle determined from hydrometer gradation curve (see Figure G.5)

L = Length of a containment (chamber) system

We = Width of a containment (chamber) system

= 8 m bottom width is considered appropriate for highway construction application

Incorporating the above relationship, the A_{eff} can be estimated from the following curve (Figure G.7).

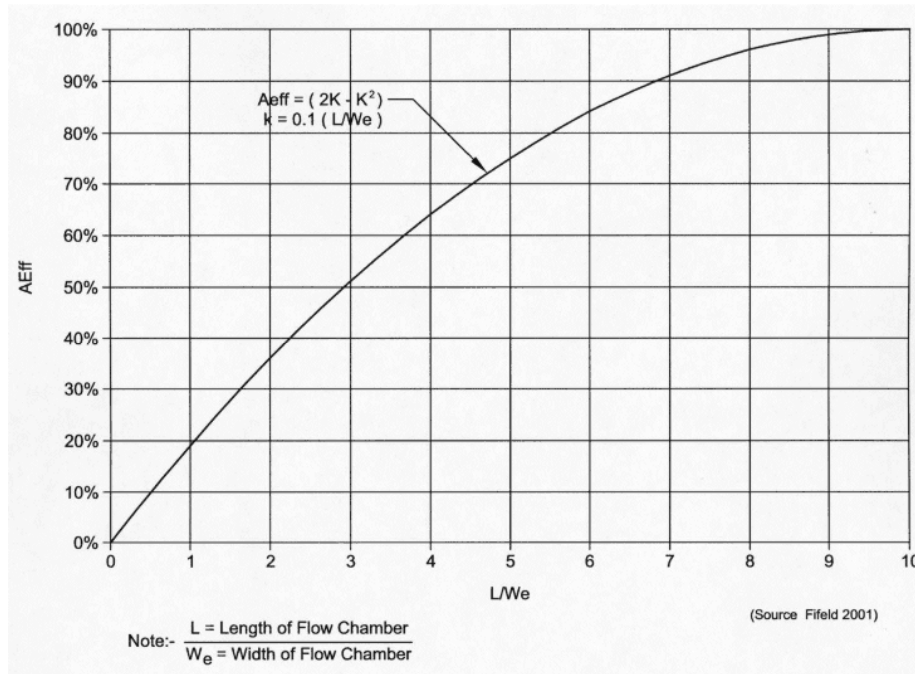

Figure G.7: Apparent Effectiveness (A_{eff}) of a Sediment Containment System

Source: Fifield, 2001

Design Example

A simple design example is presented in Appendix H as H.16.

THIS PAGE LEFT BLANK INTENTIONALLY.

APPENDIX H

DESIGN EXAMPLES

THIS PAGE LEFT BLANK INTENTIONALLY.

H.1 Introduction

In this section, 17 design examples are included to illustrate the successive stages involved in the design of erosion measures required in a grading project.

The different phases of erosion control calculations and design, and the corresponding examples, are shown in the following table.

| Description | | Example |
|--------------------------------------|---------------------------------|----------------|
| Erosion Potential | Single Slope | H.1, H.6 |
| | Irregular (bench) Slope | H.4, H.5 |
| | Low Embankment Slope | H.7 |
| | Variation with Soil Types | H.3a, H.3b |
| | For Varying Site Hazards | H.2 |
| Channel Protection | Vegetative Lining | H.8 |
| | RECP Mat (soil covering) Lining | H.9 |
| | Gravel Lining | H.10 |
| | Riprap Lining | H.11 |
| | Concrete Lining | H.12 |
| | Gabion Mat Lining | H.13 |
| Flow Depth Estimation | | H.14 |
| Sediment Barriers – Storage Capacity | | H.15 |
| Sediment Basin/Trap | | H.16 |

Example H.1 (Erosion – Single Slope)

A highway construction site just north of the city of Edmonton requires the excavation of a large uniform cut-slope approximately 30m in length at a 3H:1V slope (roughly 33%). Excavation and grading of the slope is to occur through the spring and summer (May through August) and the site will be highly disturbed during the course of the construction period. Top soil placement and seeding is scheduled to take place at the end of August.

The exposed soils are expected to be normally consolidated and consist of silty clay. Supporting field investigation information for the soil indicates the following:

| Agriculture Soil Data | Geotechnical Soil Data |
|-----------------------------|----------------------------|
| Classification: CL | Classification CL-ML |
| 50% Silt and Very Fine Sand | Plasticity Index (PI) = 15 |
| 10% Sand >0.1 mm | Plastic Limit (PL) = 27 |
| 0% Organic Matter Content | Moisture Content = 26% |

Using the RUSLE, determine the Site Erosion Potential for this particular construction site.

1. Determine the appropriate Rainfall Factor (R_t) for the Construction Area.

From the Isoerodent Map (Figure B-1) the R-factor for the Edmonton area is 350 ($\text{MJ mm ha}^{-1} \text{ year}^{-1}$) and the corresponding winter adjustment value (Figure B-3) R_s is 20 ($\text{MJ mm ha}^{-1} \text{ year}^{-1}$). The total rainfall factor R_t is therefore 370 ($\text{MJ mm ha}^{-1} \text{ year}^{-1}$).

2. Determine the Monthly Distribution of the Rainfall Factor (R_t).

The monthly distributions are summed for the period of anticipated construction that the soil is expected to be exposed (e.g., without top soil/vegetation). In this example, top soiling and seeding is scheduled to occur at the end of August.

The summed monthly distributions are expressed as a percentage of the total annual value.

From the supporting information (Table B-1 and Figure B-4) shown in Appendix B. The monthly distribution (Figure B-4) of the Rainfall factor for the Edmonton area over the construction months is as follows: May (10%), June (20%), July (25%) and August (15%). Therefore, R_t for this particular site over the period of construction noted is equal to 240 ($\text{MJ mm ha}^{-1} \text{ year}^{-1}$), which is about 70% of the total annual value.

3. Determine the Slope Factor (LS).

The slope factor table, which supports the equation for a uniform slope is shown on Table B-3.

For an average slope length of 30 m with a slope gradient of 33% a corresponding slope factor of approximately 5.4 is interpolated.

Applying the suggested Topographic Adjustment factor (\emptyset_{LS}) of 0.8 (see Section 6.2.3.2) results in an adjusted LS of 4.3.

4. Determine the Soil Erodibility Factor (K) for the Soil to be exposed during Construction.

From Figures B-6 and Figure B-7, Clay Loam has a corresponding Structure Code of 4 and a Permeability Code of 4.

Using the Soil Erodibility Nomograph in Figure B-5 for the given soil structure, permeability and composition, the exposed soil is estimated to have an Erodibility Factor (K) of 0.047.

Applying the suggested Soil Erodibility Adjustment factor (\emptyset_K) of 0.8 (see Section 6.2.2.2) results in an adjusted K of 0.038.

5. Determine Management (C) and Support Practice (P) Factors.

This slope is expected to produce a highly disturbed surface that is relatively compacted and smooth from the excavation and grading process. Furthermore no treatments are being applied to the slope, therefore the C Factor (Table B-6) and P Factor (Table B-7), for this site follow that for a bare soil (packed and smooth) and are both equal to 1.0.

It should be noted that some immediate reduction (from 1.0 to 0.9) can be made to the Support Practice (P) Factor if the slope is roughened during the excavation grading process. Roughening of the slopes is considered a Minimum Measure for all slopes.

6. Calculate the Soil Erosion Potential (Soil Loss) for this Construction Site.

A summary of the RUSLE parameters is as follows:

$$\mathbf{Rt} = 240 \text{ (MJ mm ha}^{-1} \text{ year}^{-1}\text{) (adjusted for construction season 0.70 of annual)}$$

$$\mathbf{K} = 0.038 \text{ (adjusted by } \emptyset_K = 0.8\text{) (MJ mm ha}^{-1} \text{ hour}^{-1}\text{)}$$

$$\mathbf{LS} = 4.3 \text{ (adjusted by } \emptyset_{LS} = 0.8\text{)}$$

$$\mathbf{C} = 1.0$$

$$\mathbf{P} = 0.9 \text{ (with slopes roughened)}$$

Using RUSLE: **Estimated Soil Loss (A) = R x K x LS x C x P**

$$\mathbf{Soil Loss (A) = 35.3 \text{ (tonnes ha}^{-1} \text{ year}^{-1}\text{)}$$

This value represents the estimated soil loss from this site over the period of construction prior to placement of top soil and seeding.

Example H.2 (Erosion Potential and Site Hazard)

1. Determine the Site Erosion Hazard Classification for the soil loss evaluated in Example H.1 where Soil Loss (A) = 29.7 tonne ha⁻¹ year⁻¹.

Based on the estimated site erosion potential for the period of construction noted, and the general hazard classes shown in Table 6.1, a HIGH site hazard class is indicated for this particular slope.

| RUSLE Erosion Hazard Classification | | Site Hazard Evaluation | |
|--|------------------------------|----------------------------|--------------|
| Soil Erosion Potential (A) (tonnes/ha/yr) | Site Hazard Class (RUSLE) | Soil Loss (tonne/ha/yr) | Hazard Class |
| <6 | Very Low | | |
| 6-11 | Low | | |
| 11-22 | Moderate | | |
| 22-33 | High | | |
| >33 | Very High | 35.3 | Very High |

Example H.3a (Variations of Erosion Potential for Soil Types using RUSLE (Section 6.2))

Various Soil Types:

Using the average K values (from Table B-2, Appendix B) for various soil textures and multiply by \emptyset_R , similar evaluation are assessed for varying soils for the similar site condition in Example H.1. The following table provides a summary of various soils types for the same construction site to show the sensitivity of site erosion potential classification to various types of soil.

Table Comparing Various Soils and Erosion Potential (Edmonton Area)

| Soil Type | Average Erodibility Factor (K) x \emptyset_K | Soil Loss Potential (A) | Site Erosion Potential |
|-------------------|---|-------------------------|------------------------|
| Very Fine Sand | 0.057 x 1.0 = 0.057 | 52.9 | Very High |
| Silt Loam | 0.050 x 0.8 = 0.040 | 37.1 | Very High |
| Clay Loam | 0.040 x 0.8 = 0.032 | 29.7 | High |
| Clay | 0.03 x 0.8 = 0.024 | 22.3 | Moderate to High |
| Sandy Loam | 0.017 x 0.8 = 0.014 | 13.0 | Moderate |
| Heavy Clay | 0.02 x 0.8 = 0.016 | 14.9 | Moderate |
| Coarse Sandy Loam | 0.009 x 0.8 = 0.007 | 6.5 | Low to Very Low |
| Sand | 0.001 x 1.0 = 0.001 | 0.9 | Very Low |

Note: Soil Loss Potential (A) in tonnes/ha/year

Note that for the same soil type (e.g., Clay Loam to Sandy Clay Loam) two different erodibility factors and subsequently site erosion potentials are calculated. This demonstrates the sensitivity of the soil class and the importance of determining the proper soil classification based on all available information such as geotechnical assessments and lab testing. It is noted that for sand material, no modifications to Erodibility is applied (i.e., $\emptyset_R=1$). The use of typical values

for determining the soil erodibility factor (K) is only recommended when specific soil information is unavailable or cannot be obtained.

Example H.3b (Variation of Erosion Potential for Sample Alberta Soils – Preliminary Estimate using USCS Chart (Figure 4.3) and Common Soil Testing Data for Highway Construction)

In this example, typical highway soil testing (grading design only) are presented to show that a preliminary measurement of soil erodibility potential can be assessed from plasticity and gradation data. Only a portion of Alberta areas is presented for illustration.

Soil type variations across Alberta are a function of a geological deposition process and geomorphology at the locations of highway construction. Soil investigation surveys for grading construction generally provide the following general and additional soil information for highway designs:

- A) General Information
 - 1. Plasticity Index (PI)
 - 2. Soil Classification (USCS)
 - 3. Field Moisture (M.C.) (%)
 - 4. Estimated Optimum Moisture (OMC) (%)
 - 5. Estimated Proctor Density (kg/m³)
- B) Additional Information (if required)
 - 1. Gradation – coarse granular soil
 - 2. Hydrometer gradation – fine grained and/or cohesive soil

The preliminary assessment of soil erodibility (by USCS chart approach) is presented in Appendix A for soil data obtained for some Alberta sites.

Example H.4 (Erosion Potential of Irregular (benched) Slope)

The effect of slope shape with multiple slope segments in reducing erosion potential is demonstrated in the following example:

- A long slope with narrow benches at the top and in the middle of the excavation is to be constructed at the same site as defined in the above example (i.e., similar soil and location). The total length of the slope is roughly 70 m and is divided into 4 segments with the following geometry.

Slope Description Summary

| Slope Segment * | Slope Length | Slope Gradient |
|-----------------|--------------|----------------|
| 1 – Top Bench * | 5.5 m | 2% |
| 2 – Mid-Slope | 30 m | 33% (3:1) |
| 3 – Mid-Bench | 3 m | 2% |
| 4 – Base Slope | 30 m | 33% (3:1) |

Note * The effect and inclusion of the top bench (Slope Segment #1) as one slope segment can provide an under-estimate of slope erosion potential; therefore the top slope segment is ignored and only 3 segments of slope are considered (#2, 3 and 4).

For each of the three effective slope segments, the slope factor (LS), slope length exponent (m) and appropriate soil loss factor (SLF) needs to be determined. These values can be easily taken from the supporting tables provided in Appendix B. Once a value for each segment has been derived, the actual slope factor (LS) for the separate segments can be determined as shown in the following summary:

Summary of Slope Factors for Slope with 3 Segments of Benched Slope

| Slope Segment # | Slope Factor (LS) Table B-3 | Slope Length Exponent (m) Table B-4 | Soil Loss Factor (SLF) Table B-5 | Segment LS (LS x SLF) |
|---|--------------------------------|--|-------------------------------------|--------------------------|
| 1 – Top Bench (N/A) | 0.2 | 0.24 | 0.71 | 0.14 (N/A) |
| 2 – Mid-Slope | 4.3 | 0.66 | 0.87 | 3.74 |
| 3 – Mid-Bench | 0.2 | 0.24 | 1.11 | 0.22 |
| 4 – Base Slope | 4.3 | 0.66 | 1.50 | 6.45 |
| ∑ Segments (LS) = 10.41 | | | | |
| Benched Slope Average LS = 10.41/3 = 3.5 | | | | |

Once the Slope Factor (LS) has been determined for each of the slope segments, the total LS for the slope is determined by summing the LS Segments (10.41) and dividing it by the number of effective slope segments (3). For this particular benched slope, the averaged LS is about 3.5. In comparison with a base slope of half height (Slope Segment #4, base slope with Segment LS = 6.45), the erosion potential (LS = 3.5) of a benched slope of twice the height is approximately 54% (i.e., LS ratio @ 3.5/6.45). In comparison with the mid-slope (Segment #2) with half height at LS = 3.74, the ratio of erosion potential of the benched slope of twice the height is approximately 93% (i.e., LS ratio @ 3.5/3.74).

This example shows the benefit of irregular slope configurations with intermediate benching can effectively reduce the erosion potential close to the equivalent of a single slope at the top half of the bench slope. It also shows that the lower portion of a benched high slope have higher erosion potential (LS = 6.45) compared with the top portion of the benched high slope (LS = 3.74).

Example H.5 (Erosion Potential of Benched Slope)

It is proposed to reduce the soil erosion on a 15 m high simple 3:1 slope by providing a 3 m wide berm at midslope (Fig. H.5). Estimate the percentage reduction in sediment yield for:

- single slope vs. benched slope
- single slope (15 m height) vs. single slope (7.5 m height)

Is benching of slope more advantageous to reducing slope height?

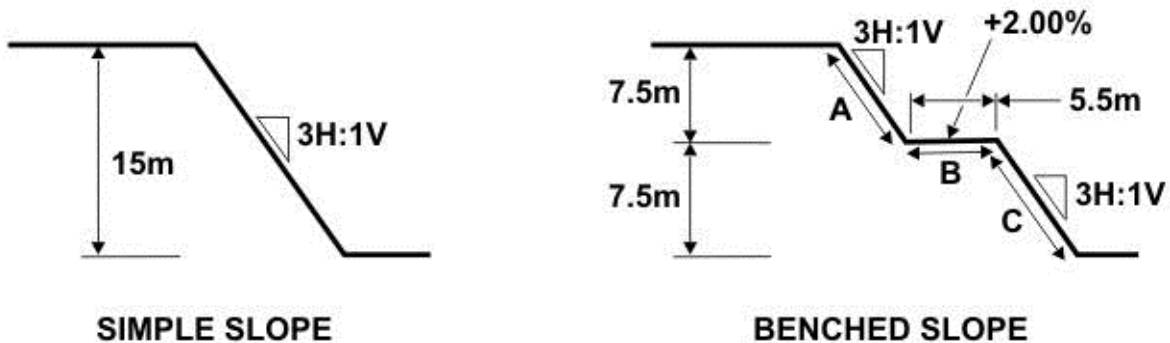

Figure (Example H.5): Cross-section with and without a bench

Step 1: Topographic Soil Loss Factor (LS) from un-benched simple slope

Length along the slope face, $L = 15 \times 3.2 = 48$ m

For $L = 48$ m and slope = 33.33%, $LS = 7$ (from Table B-3, Appendix B)

Step 2: Topographic Soil Loss Factor (LS) from benched slope

| Slope Segment | Vertical Height (m) | Inclined Length Along Slope (m) | Slope (%) | LS Factor (Table B-3 App. A) | m Factor (Table B-4 App. A) Moderate | SLF (Table B-5 App. A) | LS x SLF |
|---------------|---------------------|---------------------------------|-----------|------------------------------|--------------------------------------|------------------------|-----------------|
| A | 7.5 | 23.7 | 33.3 | 4.7 | 0.66 | 0.5 | 2.35 |
| B | 0.0 | 3.0 | 2 | 0.18 | 0.24 | 1.02 | 0.18 |
| C | 7.5 | 23.7 | 33.3 | 4.7 | 0.66 | 1.46 | 6.86 |
| | | | | | | | $\Sigma = 9.39$ |

$$\text{Bench Slope} = \frac{9.39}{3} = 3.1$$

Step 3:

Compare two cases:

a) Single slope vs. benched slope

Percentage soil loss from benched slope = $LS \text{ bench slope} / LS \text{ single slope} = 3.1/7 = 53\%$

LS percentage reduction = $(100\% - 53\%) = 47\%$ reduction of soil loss (slope design component)

b) Single slope (15 m high) vs. single slope (7.5 m high)

Percentage soil loss from low height single slope = $LS \text{ lower slope} / LS \text{ high single slope} = 4.7/7 = 67\%$

LS percentage reduction = $(100\% - 67\%) = 33\%$ of soil loss (slope design component) reduction.

Step 4:

In comparison with a single long slope (3H:1V), the benching of slope (full 15 m height) yields a 47% reduction in sediment yield; whereas the reduction of slope height (to 1/2 height at 7.5 m) only yields a 33% reduction in sediment yield. The benching of slope is more effective in reducing the percent erosion and sediment yield in comparison with reducing slope height.

Example H.6 (Erosion Potential of a Low Cutslope – Seasonal)

A simple 3:1 backslope in Grande Prairie is to be constructed in a medium plastic (CI) clay having the grain size distribution given. If the configuration of the slope is as shown in Figure (Example H.6), estimate the mean annual soil loss. What would the soil loss during the construction season from July to October?

Grain size distribution:

| Fraction | Percentage |
|--------------------------------|------------|
| Sand (2 - 0.1 mm) | 7 |
| Very fine sand (0.1 - 0.05 mm) | 10 |
| Silt (0.05 - 0.002 mm) | 49 |
| Clay (< 0.002 mm) | 34 |

Organic Content = 0%

Sand Structure = Blocky Platy Massive

Permeability = Slow

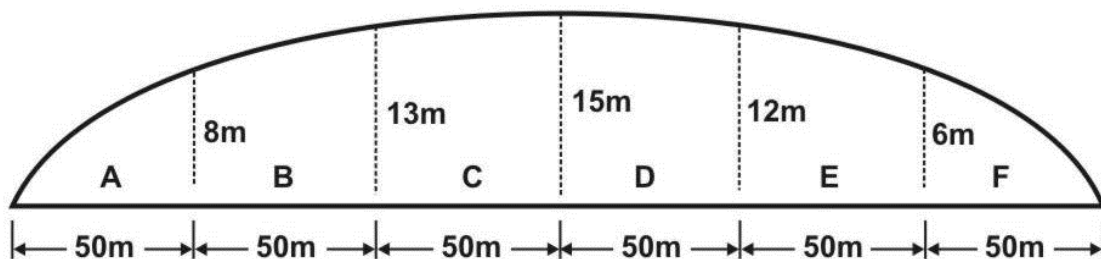

Figure (Example H.6): Elevation of Slope

Solution:

| | |
|-----------------------|--|
| Soil loss | = R.K.LS.C.P (from Equation 6.1) |
| R | = 385 (from Figures B-1, Appendix B) |
| K | = 0.032 (clay from Table B-2, Appendix B) |
| \emptyset_K | = 0.8 (highway modification factor suggested for K) |
| K_{highway} | = $0.8 \times 0.032 = 0.026$ |
| CP | = 1.0 (from Tables B-6a and B-7) |
| LS | = variable with each slope segment = $LS_{\text{average}} = 4.8$ |
| \emptyset_{LS} | = 0.8 (highway modification factor suggested for LS) |
| LS_{highway} | = $0.8 \times 4.8 = 3.8$ |
| Area | = Length x average slope length = $50 \text{ m} \times (4+10.5 \times 14+13.5+9+3) \text{ m}$ = $50 \text{ m} \times 54 \text{ m} = 2700 \text{ m}^2 = 0.27 \text{ Ha}$ |

| Slope Segment | Mean length along the slope face (m) | Slope (%) | LS factor (Fig. 6.4) |
|---------------|--------------------------------------|-----------|----------------------|
| A | 12.6 | 33.3 | 2.6 |
| B | 33.2 | 33.3 | 6 |
| C | 44.3 | 33.3 | 6.5 |
| D | 42.7 | 33.3 | 6.5 |
| E | 28.5 | 33.3 | 5.0 |
| F | 9.5 | 33.3 | 2.6 |
| Average: | 28.5 | 33.3 | 4.8 |

Note: 1 Ha = 100 m x 100 m = 10,000 m²

$$\begin{aligned}
 \text{Mean annual soil loss} &= R.K.CP.LS.Area \text{ (} K = K_{\text{highway}}; LS = LS_{\text{highway}} \text{)} \\
 &= 385 \times 0.026 \times 1.0 \times 3.8 \times 0.27 \text{ Ha} \\
 &= 10.3 \text{ tonnes/yr}
 \end{aligned}$$

Referring to Figure B-3, Appendix B (monthly rainfall distribution) for Grande Prairie.

Total percentage of soil loss from July to October = 14 + 18 + 10 + 5 = 47%.

Hence, expected soil loss from July to October = 0.47 x 10.5 = 4.8 tonnes.

Example H.7 (Erosion Potential of a Low Fill Embankment)

A soil classified as a low plastic silt (ML) according to the Unified Soil Classification System is used to construct a secondary highway embankment construction (Example H.7). Estimate the mean annual soil loss from typical low fill (1m @ 4H:1V) embankment in the Edmonton area and the grain size distribution is as given below:

| Fraction | Percentage |
|---------------------------------|------------|
| Sand (2.0 – 0.10 mm) | 22% |
| Very fine sand (0.10 – 0.05 mm) | 5% |
| Silt (0.05 – 0.002 mm) | 54% |
| Clay (<0.002 mm) | 19% |
| Organic | 0% |

- To Find Soil Erodibility $k = 0.064$
 - Use of Erodibility Nomograph (Figure B-5, Appendix B)
 - % Sand + % Silt = 59%
 - % Sand = 22%
 - % Organic = 0%
 - Soil Structure = blocky, platy, massive (4)
 - Permeability = Slow to Moderate (4)
- To Find Soil Erodibility Rating (use Figure 4.2, Section 4.4.3)
 - USCS Soil: ML – Erodibility Rating = High

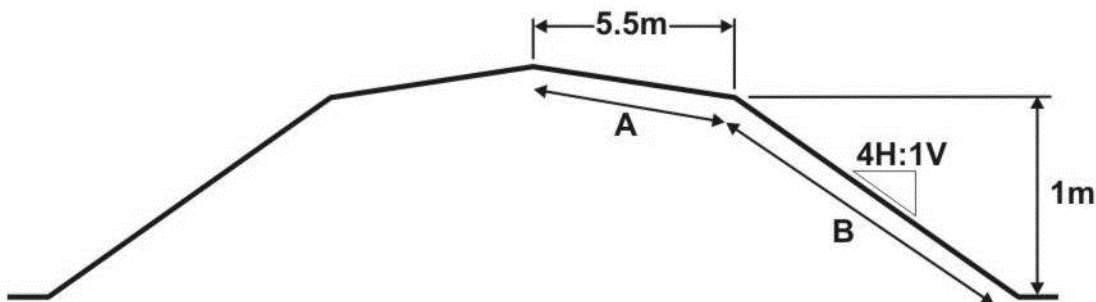

Figure (Example H.7): Secondary Highway Embankment Cross-Section

Solution:

Soil loss/hectare (A) = R K LS CP (from Equation 6.1)

R = 350 (from Figures B-1 and B-2, Appendix B)

K = 0.064 for the given soil information (Figure B-4, Appendix B)

CP = 1.0 (from Tables B-6a and B-7, Appendix B)

Equivalent LS value calculations (for half of the road cross-section):

| Slope Segment | Vertical Height (m) | Inclined length Along Slope Face (m) | Slope (%) | LS factor (Table B-3) (Appendix B) | Remarks |
|---------------|---------------------|--------------------------------------|-----------|------------------------------------|---|
| A | 0.0 | 5.5 | 2 | 0.12 (N/A) | Treated as simple slope, neglect the top segment. |
| B | 1.0 | 4.12 | 25 | 1.77 | This LS value is for a simple slope. |

Hence, Soil Loss = R.K.LS.CP

= 370 x 0.064 x 1.77 x 1.0 = 41.9 tonnes/ha/yr (agriculture soil loss)

Therefore, Soil Erosion Potential (41.9 tonne/ha/yr) is very high (Table 6.1) in agriculture practice.

Hence, for highway construction, apply suggested highway modification factor (\emptyset_K and \emptyset_{LS}) for K and LS:

$\emptyset_K = 0.8$ to K

$\emptyset_{LS} = 0.8$ to LS

Soil Loss (highway) = 41.9 t/ha/yr x 0.8 x 0.8 = 26.9 tonne/ha/yr ↔ High Erosion Hazard

Therefore, Soil Erosion Potential (26.9 tonne/ha/yr) is high (Table 6.1) in the highway construction practice. Erosion control measures such as scheduling can be adopted to effect completion of short sections of roadway in a few months followed by speedy topsoiling and seeding. This will reduce the soil erodibility for the whole year (370 tonne/ha/year) to part of a year (240 tonne/ha/year) as shown in Example H.1. Thus, with speedy construction scheduling, it will reduce the Soil Erosion Potential to Moderate for 17.4 tonne/ha/half year period (i.e., 240/370 of 26.9 tonne/year).

Example H.8 (Channel Protection – Vegetation Lining)

A roadside ditch having the geometric properties listed below is required to discharge 1 in 10 year storm estimated at $0.1 \text{ m}^3/\text{s}$ (Figure Example H.8). Determine whether unmowed, full grown Kentucky Bluegrass having a height of 250 mm will be adequate as a ditch lining.

Bed width = 3.5 m Sideslope = 4:1

Backslope = 3.1 Ditch grade = 5% = 0.05

Solution:

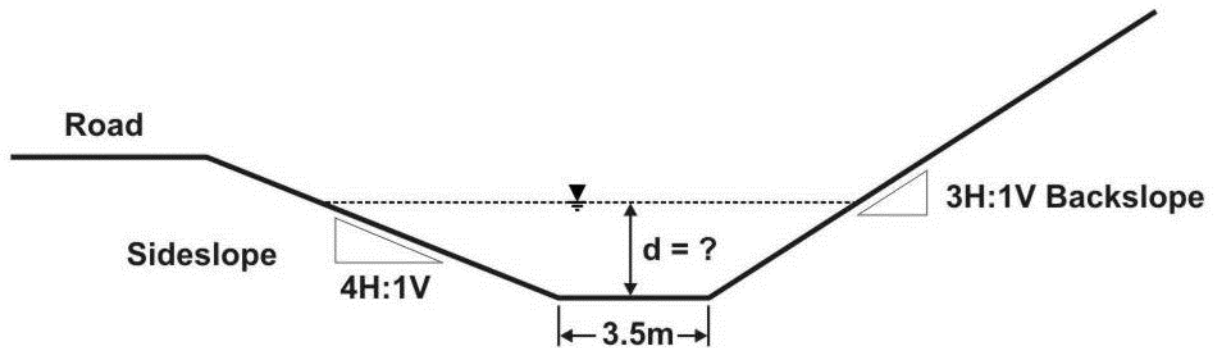

Figure (Example H.8): Typical Cross-Section

Step 1: Find the classification for the grass.

From Table F.3(a), vegetative retardance class could be either upper end of Retardance C or lower end of B; assume Retardance C.

Step 2: Estimate the depth of flow.

Trial 1:

Assume flow depth, $d = 0.075 \text{ m}$

Top width of flow = $3.5 + 4 \times 0.075 + 3 \times 0.075 = 4.025 \text{ m}$

Cross-sectional area, $A = 0.5 \times 0.075 (3.5 + 4.025) = 0.282 \text{ m}^2$

Wetted perimeter, $P = 3.5 + 0.075 (3.162 + 4.123) = 4.046 \text{ m}$

Hydraulic radius, $R = A/P = 0.282/4.045 = 0.0697 \text{ m}$

From Figure F.4, for $R = 0.228 \text{ ft}$, slope = 0.05, Manning's $n = 0.28$ (for Vegetation C)

$$\begin{aligned} \text{Discharge, } Q &= (1/n) A R^{2/3} s^{1/2} \text{ (from Equation F.3)} \\ &= (1/0.28) (0.282) (0.0697^{2/3}) (0.05^{1/2}) \\ &= 0.038 \text{ m}^3/\text{s} < 0.100 \text{ m}^3/\text{s, required} \end{aligned}$$

Hence, increase assumed flow depth.

Trial 2:

Revised flow depth, $d = 0.10$ m

Top width flow area = $3.5 + 4 \times 0.1 + 3 \times 0.1 = 4.2$ m

Cross-sectional area, $A = 0.5 \times 0.1 \times (3.5 + 4.2) = 0.385$ m²

Wetted perimeter, $P = 3.5 + 0.1 (3.162 + 4.123) = 4.228$ m

Hydraulic radius, $R = A/P = 0.385/4.228 = 0.091$ m = 0.298 ft

From Figure F.4, for Vegetation Class C, $R = 0.298$ ft, slope = 0.05, Manning's $n = 0.18$

$$\begin{aligned} \text{Discharge, } Q &= (1/n) A R^{2/3} s^{1/2} \text{ (from Equation F.3)} \\ &= (1/0.18) (0.385) (0.091^{2/3}) (0.05^{1/2}) \\ &= 0.096 \text{ m}^3/\text{s} < 0.100 \text{ m}^3/\text{s, required} \end{aligned}$$

The estimated discharge and the required discharge are very close and a flow depth of 0.1 m is o.k.

Step 3: Check the shear resistance of the grass lining.

Tractive shear stress of flow, $\tau_p = \rho d s$ (from Equation F.5)

$$= 9.81 \times 0.100 \times 0.05$$

$$= 0.049 \text{ kPa}$$

(since, $s =$ slope of channel = 0.05

$d =$ depth of flow = 0.100m

$\delta_w =$ unit weight of water = 9.81 kN/m³)

Shear resistance of Vegetation Class C = 0.048 kPa (from Table F.3(c))

Hence, the Kentucky Bluegrass lining is considered adequate.

Example H.9 (Channel Protection – Mat (soil covering) Lining)

Design a temporary ditch lining for the channel conditions in Example H.8. Assume the exposed natural ground in the ditch is incapable of resisting soil erosion in the ditch (Figure Example H.9).

Channel geometry: Sideslope = 4:1 Backslope = 3:1
 Bed width = 3.5 m Ditch grade = 5% = 0.05
 Discharge = 0.100 m³/s

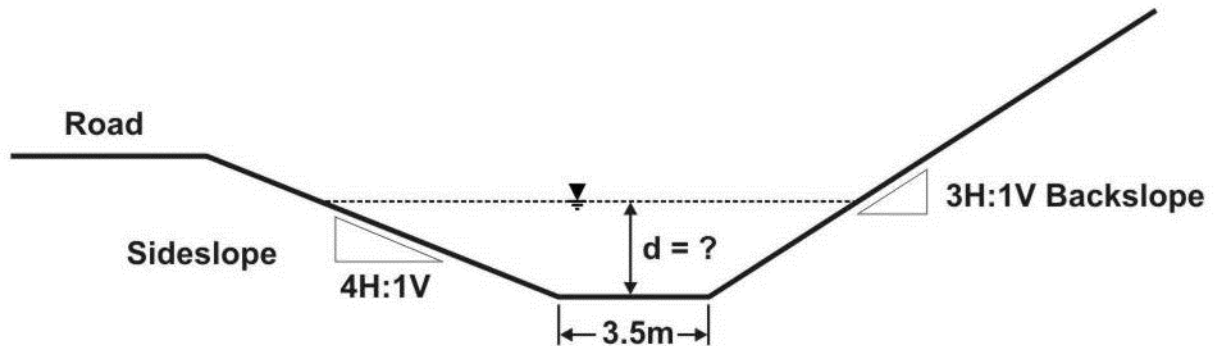

Figure (Example H.9): Typical Cross-Section

Solution:

Assuming use of a straw or wood excelsior mat

Manning's $n = 0.065$ (from Table F.2)

Step 1: Estimate the depth of flow.**Trial 1:**

Assume depth of flow = 0.075 m

Top width of the flow = $3.5 + 4 \times 0.075 + 3 \times 0.075 = 4.025$ m

Cross-sectional area, $A = 0.5 \times 0.075 \times (3.5 + 4.025) = 0.282$ m²

Wetted perimeter, $P = 3.5 + 0.075 (3.162 + 4.123) = 4.045$ m

Hydraulic radius, $R = A/P = 0.282/4.045 = 0.0697$ m

$$\begin{aligned} \text{Discharge, } Q &= (1/n) A R^{2/3} s^{1/2} \text{ (Equation F.3)} \\ &= (1/0.065) (0.282) (0.0697^{2/3}) (0.05^{1/2}) \\ &= 0.161 \text{ m}^3/\text{s} > 0.100 \text{ m}^3/\text{s} \end{aligned}$$

Hence, revise the depth of flow to a lower value, say, $d = 0.060$ m

Trial 2:

Top width of the flow = $3.5 + 4 \times 0.060 + 3 \times 0.060 = 3.92$ m

Cross-sectional area, $A = 0.5 \times 0.060 (3.5 + 3.92) = 0.222$ m²

Wetted perimeter, $P = 3.5 + 0.060 (3.162 + 4.123) = 3.93$ m

Hydraulic radius, $R = A/P = 0.222/3.93 = 0.0564$ m

$$\begin{aligned}\text{Discharge, } Q &= (1/n) A R^{2/3} s^{1/2} \\ &= (1/0.066) (0.222) (0.0564^{2/3}) (0.05^{1/2}) \\ &= 0.112 \text{ m}^3/\text{s} > 0.100 \text{ m}^3/\text{s}\end{aligned}$$

Hence, the depth of flow is close to 0.060 m, may be like 0.058 m.

Step 2: Check the shear resistance of the erosion control mat.

Tractive shear stress of flow, $\tau_p = \delta d s$ (Equation F.5)

$$= 9.81 \times 0.060 \times 0.05$$

$$= 0.029 \text{ kPa} = 29 \text{ Pa}$$

Permissible shear stress of manufactured mat (such as Excelsior mat) = 74 Pa (from Table F.3(c)).

Hence, curled wood mat (Excelsior mat) is more than adequate as a temporary ditch lining.

Example H.10 (Channel Protection – Gravel Lining)

A roadside ditch, similar in cross-section in Example H.9, is required to carry a 1 in 10 year storm discharge of $0.15 \text{ m}^3/\text{s}$ (Figure H.7). Determine the mean diameter of granular material that is required to permanently control soil erosion.

Ditch cross-section information:

Bed width = 3.5 m Sideslope = 4:1

Backslope = 3:1 Grade = 5%

Solution:

Assume using rock riprap, $D_{50} = 150 \text{ mm}$

Corresponding value of Manning's $n = 0.104$ (from Table F.2)

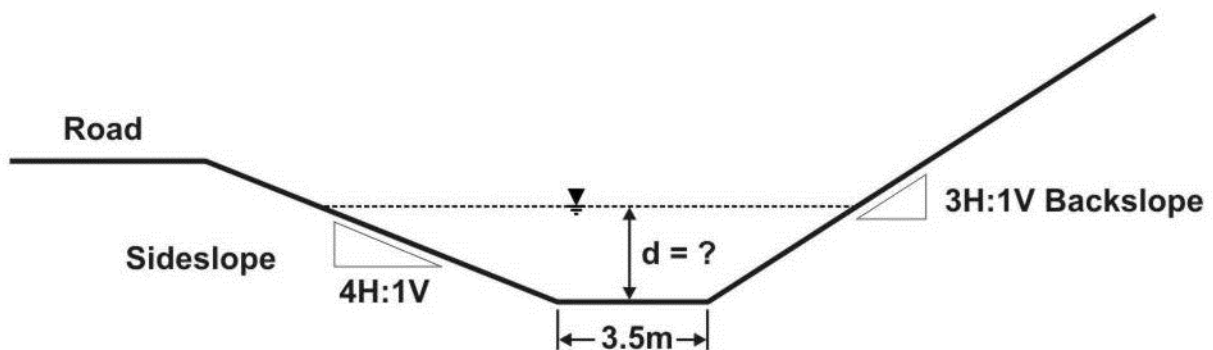

Figure (Example H.10): Typical Cross-Section

Step 1: Estimate the depth of flow.**Trial 1:**

Flow depth (say) = 0.10 m

Top width of flow area = $3.5 + 4 \times 0.1 + 3 \times 0.1 = 4.2 \text{ m}$

Cross-section area, $A = 0.5 \times 0.1 (3.5 + 4.2) = 0.385 \text{ m}^2$

Wetted perimeter, $P = 3.5 + 0.1 (3.162 + 4.123) = 4.228 \text{ m}$

Hydraulic radius, $R = A/P = 0.385/4.228 = 0.091 \text{ m}$

$$\begin{aligned} \text{Discharge, } Q &= (1/n) A R^{2/3} s^{1/2} \text{ (from Equation F.3)} \\ &= (1/0.104) (0.385) (0.091^{2/3}) (0.05^{1/2}) \\ &= 0.167 \text{ m}^3/\text{s} > 0.15 \text{ m}^3/\text{s, required} \end{aligned}$$

Try another depth slightly smaller than 0.10 m.

Trial 2:

Flow depth (say) = 0.09 m

Top width of flow area = $3.5 + 4 \times 0.09 + 3 \times 0.09 = 4.13$ m

Cross-section area, $A = 0.5 \times 0.09 (3.5 + 4.13) = 0.343$ m²

Wetted perimeter, $P = 3.5 + 0.09 (3.162 + 4.123) = 4.155$ m

Hydraulic radius, $R = A/P = 0.343/4.155 = 0.082$ m

$$\begin{aligned} \text{Discharge, } Q &= (1/n) A R^{2/3} s^{1/2} \\ &= (1/0.104) (0.343) (0.082^{2/3}) (0.05^{1/2}) \\ &= 0.139 \text{ m}^3/\text{s} < 0.15 \text{ m}^3/\text{s, required} \end{aligned}$$

Hence, the actual depth of flow would be in between 0.09 m and 0.10 m. Take 0.10 m for simplicity in further calculations.

Step 2: Check the shear resistance of the gravel lining.**Trial 1:**

$$\begin{aligned} \text{Tractive shear stress of flow, } \tau_p &= \delta d s \\ &= 9.81 \times 0.10 \times 0.05 \\ &= 0.049 \text{ kPa} = 49 \text{ Pa} \end{aligned}$$

Permissible shear stress of 150 mm diameter rock riprap = 0.096 kPa = 96 Pa (from Table F.3(c)).

Hence, $D_{50} = 150$ mm diameter riprap is more than adequate.

Try using smaller rock size riprap if possible from cost-effective considerations.

Trial 2:

Assume riprap $D_{50} = 50$ mm = 0.050 m, corresponding Manning's $n = 0.066$ (from Table F.2)

Assume depth of flow = 0.075 m

Top width of the flow = $3.5 + 4 \times 0.075 + 3 \times 0.075 = 4.025$ m

Cross-sectional area, $A = 0.5 \times 0.075 \times (3.5 + 4.025) = 0.282$ m²

Wetted perimeter, $P = 3.5 + 0.075 (3.162 + 4.123) = 4.045$ m

Hydraulic radius, $R = A/P = 0.282/4.045 = 0.0697$ m

$$\begin{aligned} \text{Discharge, } Q &= (1/n) A R^{2/3} s^{1/2} \\ &= (1/0.066) \times 0.282 \times 0.0697^{2/3} \times 0.05^{1/2} \\ &= 0.166 \text{ m}^3/\text{s} > 0.150 \text{ m}^3/\text{s, required} \end{aligned}$$

$$\text{Tractive shear stress of flow, } \tau_p = \delta d s$$

$$= 9.81 \times 0.075 \times 0.05$$

$$= 0.036 \text{ kPa} = 36 \text{ Pa}$$

Permissible shear stress of 50 mm diameter rock riprap = 0.031 kPa = 32 Pa (from Table F.3(c)).

Hence, $D_{50} = 50$ mm riprap does not satisfy the limiting permissible shear stress values marginally.

Trial 3:

Try using riprap with slightly higher $D_{50} = 60$ mm.

To find permissible shear stress for $D_{50} = 60$ mm size rock, interpolate between the permissible shear stress values of 50 mm and 150 mm size rock (from Table F.3(c)).

$$\tau_p = 32 + (96 - 32) (60 - 50) / (150 - 50) = 38.4 \text{ Pa}$$

Hence, riprap with $D_{50} = 60$ mm is adequate.

Thickness of riprap lining = (1.5 to 2.0) D_{50}

$$= 90 \text{ to } 120 \text{ mm}$$

Use thickness of 100 mm of riprap with $D_{50} = 60$ mm

(Note: 100 mm is assumed since it is a simple fraction of a metre)

Example H.11 (Channel Protection – Riprap Lining)

Estimate the mean riprap diameter that will adequately convey a discharge of $0.5 \text{ m}^3/\text{s}$ down a channel having 15% slope (Figure Example H.11). Assume the channel bed width is 1 m and the sideslope is 3:1. Also estimate the flow depth.

Solution:

Discharge, $Q = 0.5 \text{ m}^3/\text{s}$ Bed slope, $s = 0.15 \text{ m/m}$

Bed width, $w = 1.0 \text{ m}$ Sideslopes = 3:1

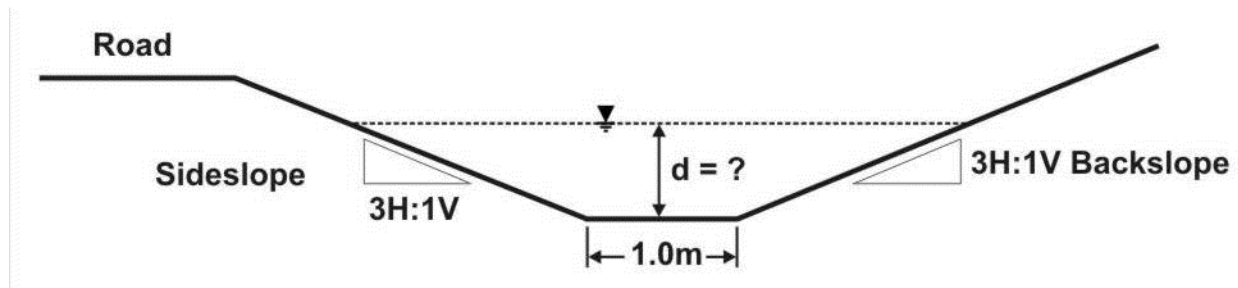

Figure (Example H.11): Typical Cross-Section

Enter Chart of Figure F.13, for, $Q = 0.5 \text{ m}^3/\text{s}$

Flow depth = 180 mm

Riprap mean diameter $D_{50} = 220 \text{ mm}$

Example H.12 (Channel Protection – Concrete Lining)

Design a concrete lining for a channel to carry a discharge of $1.5 \text{ m}^3/\text{s}$ down a steep stable slope of 3H:1V (Figure Example H.12).

Solution:**Step 1: Find the depth of flow.****Trial 1:**

Assume channel dimensions: Bed width = 1.0 m, Sideslope = 2:1, Flow depth = 0.3 m

Manning's $n = 0.013$ (from Table F.2) for 30 cm flow depth for concrete

Top width of flow area = $2 \times 0.3 + 1.0 + 2 \times 0.3 = 2.2 \text{ m}$

Flow cross-sectional area, $A = (\frac{1}{2}) (0.3) (1.0 + 2.2) = 0.48 \text{ m}^2$

Wetted perimeter, $P = 1.0 + 2 \times 0.3 \times 2.236 = 2.34 \text{ m}$

Hydraulic radius, $R = A/P = 0.48/2.34 = 0.205 \text{ m}$

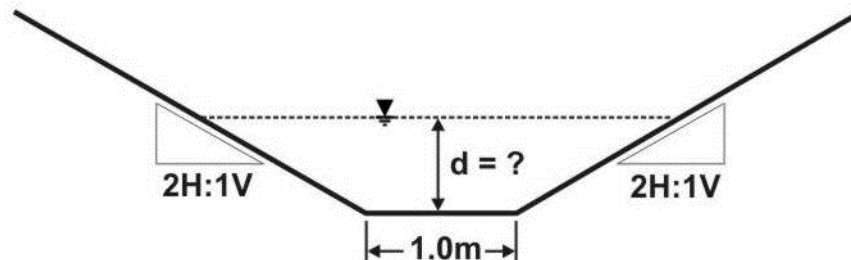

Figure (Example H.12): Typical Cross-Section

Discharge, Q (from Manning's equation)

$$\begin{aligned} Q &= (1/n) A R^{2/3} s^{1/2} \text{ (Equation F.3)} \\ &= (1/0.013) (0.48) (0.205^{2/3}) (0.33^{1/2}) \\ &= 7.38 \text{ m}^3/\text{s} \end{aligned}$$

This section is too large for the desired discharge, hence revise bed width and flow depth.

Trial 2:

Assume, Bed width = 0.5 m Flow depth = 0.2 m

Top width of flow area = $2 \times 0.2 + 0.5 + 2 \times 0.2 = 1.3$ m

Cross-sectional area, $A = (\frac{1}{2}) (0.2) (0.5 + 1.3) = 0.18$ m²

Wetted perimeter, $P = 0.5 + 2 \times 0.2 \times 2.236 = 1.39$ m

Hydraulic radius, $R = A/P = 0.18/1.39 = 0.129$ m

$$\begin{aligned} \text{Discharge, } Q &= (1/n) A R^{2/3} s^{1/2} \\ &= (1/0.013) (0.18) (0.129^{2/3}) (0.33^{1/2}) \\ &= 2.04 \text{ m}^3/\text{s} > 1.5 \text{ m}^3/\text{s}, \text{ required by a slight margin} \end{aligned}$$

Hence, bed width = 0.5 m and Flow depth = 0.2 m are adequate.

Add freeboard = 0.2 m (equal to depth of flow), hence, required total depth of channel = 0.4 m

Example H.13 (Channel Protection – Gabion Mat Lining)

Estimate the rock size and gabion thickness required to discharge of $0.3 \text{ m}^3/\text{s}$ down a channel with a 20% gradient (Figure Example H.13). Assume the bed width of the channel = 1.5 m and sideslopes = 3:1.

Solution:**Step 1: Find depth of flow.**

Discharge, $Q = 0.3 \text{ m}^3/\text{s}$ Bed slope, $s = 0.20 \text{ m/m}$
 Bed width, $w = 1.5 \text{ m}$ Sideslopes = 3:1

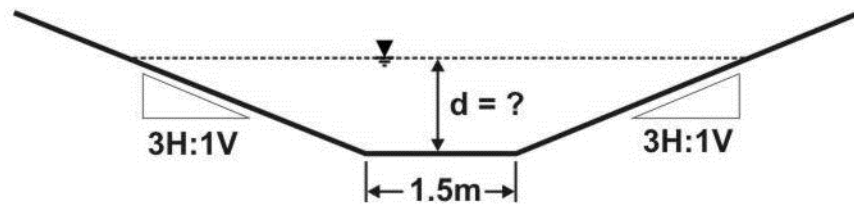

Figure (Example H.13): Typical Cross-Section

Enter Chart of Figure F.20, for $Q = 0.3 \text{ m}^3/\text{s}$, and Flow depth = 90 mm

Step 2: Determine the size of gabion filling rock.

Tractive shear stress of flow, $\tau_p = \delta d s$

$$\begin{aligned}\tau_p &= 9.81 \times 0.090 \text{ m} \times 0.20 \\ &= 0.176 \text{ kPa} = 3.676 \text{ lbs/ft}^2 \text{ (assume } 1 \text{ kPa} = 20.886 \text{ lbs/ft}^2\text{)}\end{aligned}$$

From Figure F.15, for $\tau_p = 0.176 \text{ kPa}$, mean rock size diameter = 0.5 ft = 150 mm

Step 3: Find thickness of gabion mattress:

a) From Figure F.16, for $\tau_p = 0.176 \text{ kPa}$

Minimum thickness = 0.25 ft = 0.076 m

b) From the guidelines mentioned in Section F17.1

Mattress thickness = (2 to 3) times D_{50}
 $= 300 \text{ mm to } 450 \text{ mm if } D_{50} = 150 \text{ mm rock used}$

c) Gabion mattress thickness as manufactured is from 0.25 m to 0.45 m

Hence, adopt 0.30 m thickness, which is close to 2 times D_{50} .

Example H.14 (Flow Depth Estimation)

What would be the flow depth in Example H.11, if the sideslope is 4H:1V (Figure Example H.11)?

Solution:

From Example H.11, flow depth = 180 mm = 0.180 m bed width = 1.0 m

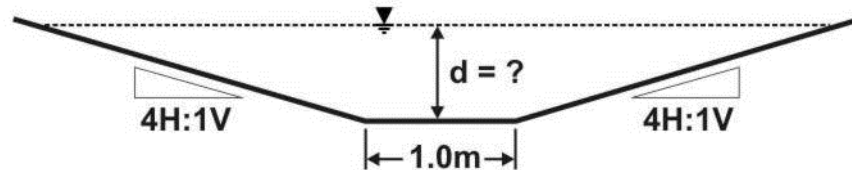

Figure (Example H.14): Typical Cross-Section

Top width of flow area = $1.0 + 3 \times 0.180 + 3 \times 0.180 = 2.08$ m

Area of flow = $0.5 \times 0.180 (1.0 + 2.08) = 0.277$ m²

Let d be the depth of flow, then top width of flow = $1.0 + 4d + 4d = 8d + 1$

Area of cross-section = $0.5 \times d \times (8d + 1 + 1) = 4d^2 + d$

Equating the areas of 3:1 and 4:1 sideslope of the ditch configurations, $4d^2 + d = 0.277$ m²

Solving the equation for d , $d = 0.163$ m < 0.180 m, marginally

Example H.15 (Sediment Storage Capacity for Sediment Barriers)

Assume a typical secondary highway roadside ditch section with the geometric properties given below (Figures Example H.15a and H.15b). Determine the appropriate ditch barrier spacing to control the sediment loss from the site. Assume a mean annual sediment yield of $40 \text{ m}^3/\text{ha}$.

Bed width = 3.5 m Barrier height = 0.5 m Backslope = 3:1 (horiz : vert)
 Ditch grade = 4% Ditch depth = 1 m Sideslope = 4:1 (horiz : vert)

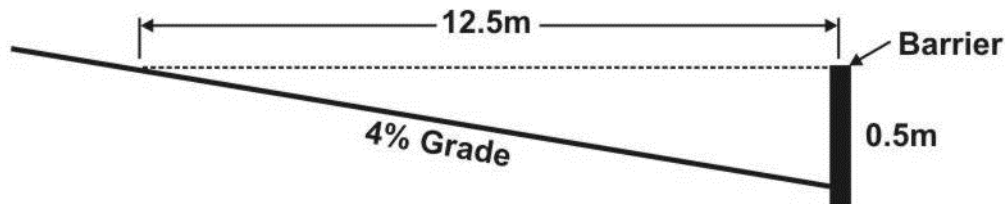

Figure (Example H.15a): Longitudinal Profile

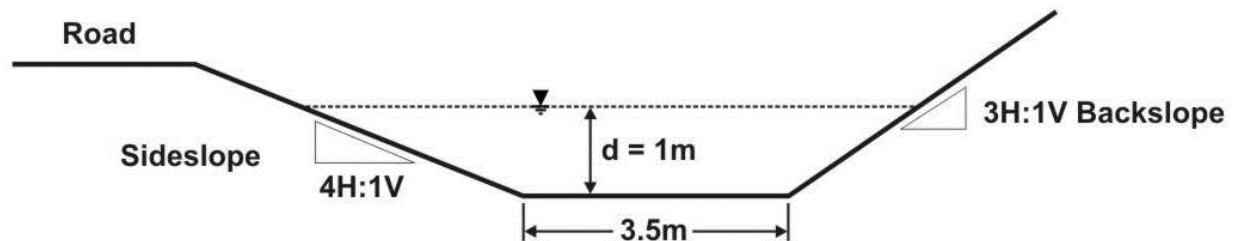

Figure (Example H.15b): Cross-Section

Solution:

Step 1: Calculate the length of sediment spread behind a barrier.

Since the ditch grade is 4% and the height of a barrier is 0.5 m, the sediment will be stored over a ditch length of 12.5 m behind the barrier.

Also, note that, while calculating the likely sediment volume behind a barrier, the cross-section of the deposited sediment changes from one location to another within this 12.5 m distance.

Step 2: Calculate the volume of sediment storage behind a barrier.

From Figure H.15a,

Top width of the storage area at the barrier = $3.5 + 4 \times 0.5 + 3 \times 0.5 = 7 \text{ m}$

Top width of storage at 12.5 m away from and behind the barrier = 0 m

Area of cross-section at the barrier = $0.5 \times 0.5 \times (3.5 + 7.0) = 2.625 \text{ m}^2$

Area of cross-section 12.5 m behind the barrier = 0.0 m^2

Hence, volume of storage (assuming a linear variation between the two locations)

$$= 0.5 \times (2.625 + 0) \times 12.5 = 16.4 \text{ m}^3$$

Assume only half of this volume is allowed to be filled up by sediment. Reason: the remaining will be like a buffer space for erosion during unanticipated very heavy rainfall seasons or, if cleaning is done in alternate years.

Hence, sediment volume likely to be deposited behind a barrier = 8.2 m^3

Area served by one barrier = $8.2/40 = 0.205 \text{ ha}$

Likely width of disturbed area = $6 + 4 \times 1 + 3.5 + 12.6 = 26.1 \text{ m}$ (from Figure H.15c), assuming the ground is disturbed up the backslope by a distance of 12.6 m.

Note: $1 \text{ ha} = 10,000 \text{ m}^2$

Hence, spacing = $0.205 \times 10,000/26.1 = 78.5 \text{ m}$, say, 75 m spacing for convenience of construction. For practical and conservative purposes, a spacing of 60 m (every 3 stations of 20 m) can be considered.

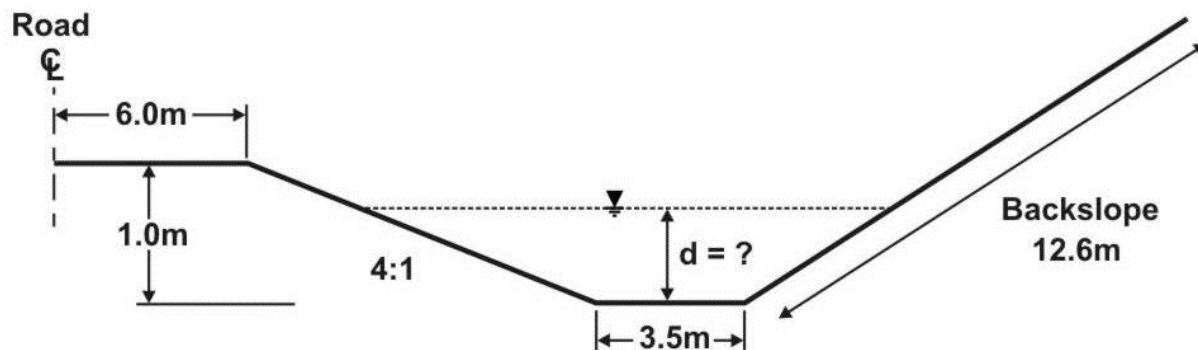

Figure (Example H.15c): Cross-Section Profile up the Backslope

Example H.16 (Design of Sedimentation Pond/Trap)

In the Peace River area, the construction of a highway alignment down a river valley exposed a cutslope of 3 hectare area of bare soil surface. The average cutslope is a single slope at 3H:1V and 25 m length. The cutslope was stipulated for surface texturing with track walking up/down slope. The contractor will schedule to excavate the slope to follow with topsoiling and seeding within the 3 months of July, August and September. The alignment traverses the river course and there is direct connectivity to a fish bearing stream of high environmental sensitivity. The soil types of the area consist of 60% silty low plasticity clay (ML to CL) and 40% high plasticity clay (CH). No rainfall gauge station is available for the immediate area and the hydraulic/hyrotechnical engineer's assessment on inflow runoff quantity into the sedimentation pond is not available. Soil sampling of the ML soil was undertaken at mid height of cutslope and a hydrometer gradation analysis of the ML soil was carried out in preliminary recognition of the erodibility of the ML material.

Hydrometer Gradation (see Figure Example H.16c)

| Soil Particles | Percent | Other USCS Properties (Figure 4.1) | |
|----------------|---------|------------------------------------|----------|
| Clay | 14 | Plasticity Index | PI = 10% |
| Silt | 43 | Liquid Limit | LL = 24% |
| Sand | 41 | ML to CL material | |
| Gravel | 2 | | |

Note: This design follows the design approach of Fifield 2001 with engineering modifications.

Questions:

- 1) **What is preliminary soil erodibility assessment?**
- 2) **What is the amount of erosion sediment from the cutslope?**
- 3) **What is the hazard rating of the site; appropriate action if required?**
- 4) **If sedimentation pond is required, what storage volume of sediment laden runoff can be anticipated?**
- 5) **How to develop the requirement for the design of a sedimentation pond?**
- 6) **Design of sedimentation control (as a perimeter control measure adjacent to high risk area).**

Question (1): Evaluate the preliminary soil erodibility:

Determine preliminary Soil Erodibility based on USCS from Figure 4.2.

For CH soil, soil erodibility is considered LOW – no concern

For ML soil, soil erodibility is considered HIGH – concern

Answer: For ML soil, erodibility is considered **HIGH** (Figure 4.2) and of concern
Hydrometer gradation analysis is necessary

Question (2): What is the amount of erosion sediment (SOIL LOSS) from the cutslope?

Construction Conditions:

- a) Erodible Soil Distribution Area: 60% of the area is ML soil of high erodibility
 b) Construction Schedule 3 months: Soil Erodibility (K) reduction by 35%

(July + Aug + Sept = 41 + 17 + 7 = 65% of annual Erodibility Factor (R))

SOIL LOSS (A): evaluate using RUSLE formula (Equation 6.1) with highway modification factorsRUSLE_{highway}

$$A = R \times K_{\text{highway}} \times LS_{\text{highway}} \times C \times P \quad (\text{Equation 6.1})$$

$$= 325 \times 0.07 \times 4.1 \times 1 \times 0.9$$

$$= 84 \text{ tonne/ha/yr} \quad \text{Soil Loss Hazard: very high (Table 6.1)}$$

x 0.6 erodible soil distribution area in (a)

x 0.65 construction schedule time distribution per year in (b)

Therefore,

$$A_{\text{construction period}} = 84 \times 0.6 \times 0.65$$

$$= 32 \text{ tonne/ha/construction period} \quad \text{Soil Loss Hazard} = \text{high (Table 6.1)}$$

Where:

$$R = 325 \text{ MJ mm ha}^{-1} \text{ h}^{-1} \text{ y}^{-1} \quad (\text{Figure B-1; Appendix B})$$

$$K_{\text{agriculture}} = 0.088 \text{ MJ}^{-1} \text{ mm}^{-1} \text{ tonne hr} \quad (\text{Figure B-5; Appendix B})$$

$$K_{\text{highway}} = 0.070 \quad (K_{\text{agriculture}} \times 0.8 \text{ (highway modification factor } \emptyset_K) \text{ see Section 6.2.2.2)}$$

% silt + sand = 84 (use 70%; maximum value in Figure B-5; overestimation of K is possible)

% sand = 41

% OM = 1 (assume 1 for using Figure B-5)

Soil Structure = 4 (blocky, platy, massive)

Permeability = 3 (slow to moderate)

$$LS_{\text{agriculture}} = 5.2 \quad (\text{Table B-3; Appendix B})$$

$$LS_{\text{highway}} = 4.1 \quad (LS_{\text{agriculture}} \times 0.8 \text{ (highway LS modifier factor } \emptyset_{LS}) \text{ see Section 6.2.3.2)}$$

Single slope

33% Slope (3H:1V)

Slope length = 25 m

$$C = 1 \quad (\text{Table B-6a; bare soil with no mulch})$$

$P = 0.9$ (Table B-7; bare soil freshly rough)

Answer: SOIL LOSS (A)

$A_{\text{annual}} = 84 \text{ tonne/ha/yr}$

$A_{\text{construction period}} = 32 \text{ tonne/ha/construction period}$

Question (3): What is the hazard rating of the site?

Answer:

$A_{\text{annual}} = 84 \text{ tonne/ha/yr}$ Soil Loss Hazard: Very High (Table 6.1)

$A_{\text{construction period}} = 84 \times 0.6 \times 0.65$
 $= 32 \text{ tonne/ha/construction period}$ Soil Loss Hazard: High (Table 6.1)

Answer:

The rating of soil loss hazard per year is very high:

- Therefore scheduling of construction to minimize bare soil exposure and speedy topsoiling and seeding are required to lower the annual soil loss hazard rating.
- The rating of soil loss hazard per construction season is still high after scheduling of the construction.
- Therefore the design of sediment pond at perimeter of site is required.

Question (4): If sedimentation pond is required, what storage volume of sediment laden runoff can be anticipated? How to develop the requirements of a sedimentation pond?

If available runoff estimate is not available, it is appropriate to use 250 m³/ha of disturbed soil areas for estimating storage volume of sedimentation pond. This is based on 25 mm runoff per hectare (EPA requirements; (Fifield 2001)). The 25 mm runoff per hectare is appropriate for 40 to 45 mm precipitation over loamy clay (Type C) to clay (Type D) (see Figure 4.5).

In areas of severe land constraint, a minimum size of sedimentation pond at 150 m³/ha of disturbed land may be considered in accordance with the risk level of the site. Thus, a pond size of 450 m² may be a minimum requirement for 3 ha of land disturbed.

Answer:

A 750 m³ storage volume as preliminary estimate is appropriate for 3 ha of disturbed area.

Question (5): How to develop the requirement for the design of a sedimentation pond?

The following parameters should be available.

Steps to determine:

- 1) Target size particle (D_s) for settlement performance
- 2) Settling velocity (V_s) of target size particle (D_s)
- 3) Outflow (Q_o) performance and capacity of outflow structure of Sedimentation Pond

- 4) (i) Inflow (Q_i) Runoff Estimation based on affected area, and (ii) Estimate of Width (W) requirement of outflow structure
- 5) What is surface area (SA) of sedimentation pond using 1m retention depth?
- 6) What is gradation (PEG) of the material coarser than the target size particle for sedimentation?
- 7) What is the efficiency of the sedimentation pond?

Step 1: Target size particle (D_s) for settlement

$D_s = 0.03$ mm medium size silt is targeted for sedimentation.

Step 2: Settling velocity (V_s) of target size particle

Result:

$V_s = 0.06$ cm/s for $D_s = 0.030$ mm size medium silt particles @ 10°C water temperature (Table G.1)

Step 3: Outflow performance and outflow capacity (Q_o) of Sedimentation Pond

The outflow capacity (Q_o) of sedimentation seepage flow from outflow structure of a sedimentation pond can be more accurately assessed with the use the following properties of construction material and design geometry (Refer to Figure G.3a for pictorial of the following dimensional properties).

- 1) porosity (ρ) and permeability of filter system
- 2) average rock diameter (D) of gravel berm
- 3) width (W) of permeable berm
- 4) flow length (T) through filter system
- 5) height (H) of water under retention

Equation G.4 (proposed by Jiang et al., 1998) on relationship on outflow performance provides reasonable results for a permeable berm outlet system was considered appropriate for use in sedimentation retention (Fifield, 2001). See Section 12 for details.

$$Q_o = 0.327 e^{1.5S} (g D_{50} / T)^{0.5} \rho W H^{1.5} \quad (\text{Equation G.4})$$

(Jiang et al., 1998)

Where:

Q_o = Outflow capacity of containment system (m^3/s)

g = Acceleration due to gravity = 9.8 m/s^2

D_{50} = Mean diameter of the rock (m); for this equation

- W = Total width of the barrier (m)
 ρ = Porosity of the rock barrier
 T = Thickness of the barrier (m)
 H = Hydraulic head (m)
 S = Slope of channel (%) (generally varies from 0% to 7% for highway gradeline profiles)

The concept of Equation G.4 is presented in Figure G.3 and a typical detail of permeable gravel outlet berm option is presented in Figure G.4.

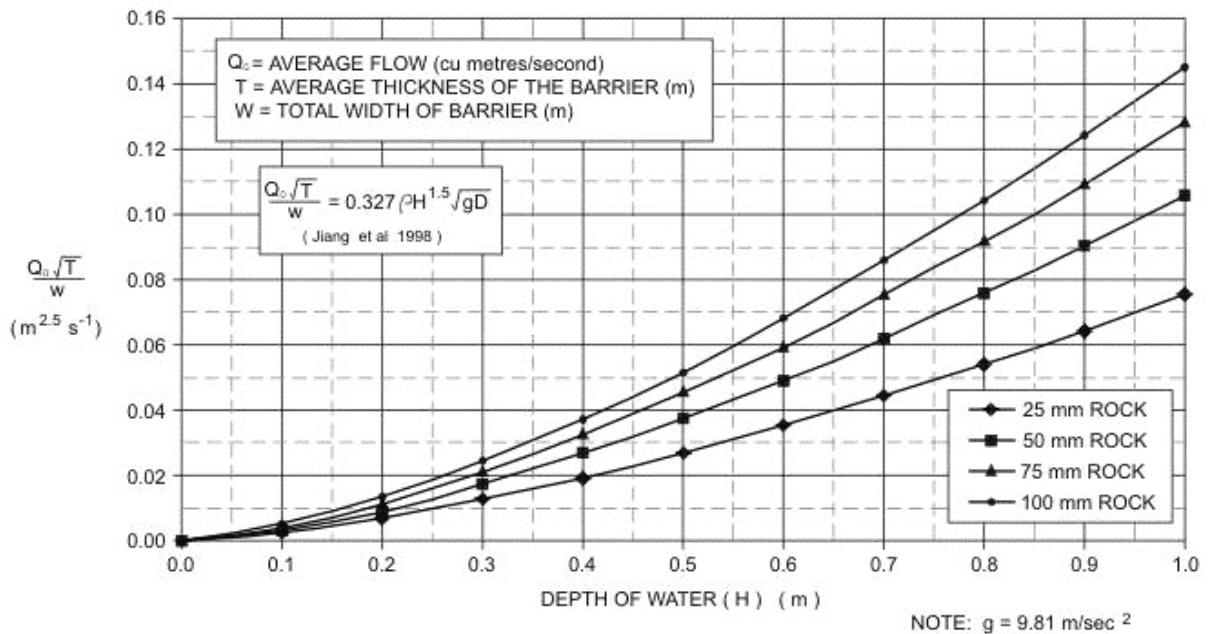

Figure (Example H.16a)

Figure G.3b: Flow (Q) through an Outlet Barrier (g) of various Diameter (D) Rocks in Gabion Basket

Step 4: i) Inflow runoff estimation based on affected area**ii) Estimate of width requirement of outflow structure**

The hydrologist or hydrotechnical engineer should assess the terrain drainage and the affected area of construction to assess the amount of sediment laden inflow runoff (Q_i) into the sedimentation pond area. The inflow is compared with the estimate outflow capacity (Q_o) of the permeable outlet to design the width (W) of the permeable outlet.

use: $Q_i = 0.5 \text{ m}^3 \text{ s}^{-1}$ (assumed)

at full storage: $Q_o = Q_i = 0.5 \text{ m}^3 \text{ s}^{-1}$

then for: $Q_o = 0.08W$

$W = 6.3 \text{ m}$

Results:

For pragmatic design consideration for permeable outlet, a practical outlet width ($W = 6.3 \text{ m}$) can be considered to provide an outflow capacity ($Q_o = 0.5 \text{ m}^3/\text{s}$).

Step 5: What is surface area of sedimentation pond

It is appropriate to consider:

- 1) inflow (Q_i) equal to outflow (Q_o) (in Step 4)

$$Q_i = Q_o \quad (\text{Equation G.3})$$

- 2) and/or minimum storage volume of 250 m^3 /ha disturbed land for design of sedimentation pond

Thus, Inflow Runoff Volume (Q_o) = $0.5 \text{ m}^3 \text{ s}^{-1}$ (from step 4), then find surface area of pond (SA)

Pond Surface Area:

$$\begin{aligned} \text{SA} &= 1.2 Q_o \div V_s && (\text{Equation G.5}) \\ &= 1.2 (0.5 \text{ m}^3 \text{ s}^{-1}) \div 0.0006 \text{ cm/s} \\ &= 1000 \text{ m}^2 \end{aligned}$$

Where: $V_s = 0.06 \text{ cm/s} = 0.0006 \text{ m/s}$ (see step 1)

Step 6: What is Percentage Material Equal to or Greater (PEG) (i.e., gradation of the material coarser than the target size particle for sedimentation)

From hydrometer gradation curve results (see Figure Example H.16c) for:

Where:

$D_s = 0.03$ mm medium to fine size silt as target size particle

PEG = 55% (or 45% smaller in hydrometer gradation curve)

Step 7: What is the efficiency and design of the sedimentation pond?

Apparent efficiency (A_{eff}) can be determined by configuration of sedimentation using L/We ratio concepts.

Net efficiency (N_{eff}) is the combined effect of pond configuration settling velocity of target size particle as assessed in PEG.

$$\begin{aligned} N_{\text{eff}} &= A_{\text{eff}} \times \text{PEG} && \text{(Equation G.11)} \\ &= 0.92 \times 0.55 \\ &= 50\% \end{aligned}$$

Where : $A_{\text{eff}} = 92\%$ using $L/We = 7$ (Figure G.7)

PEG = 55% for $D_s = 0.03$ mm (medium to fine silt) (Step 6)

EBA Engineering *FIGURE EX 14.16 PEG (GRADATION) ASSESSMENT*

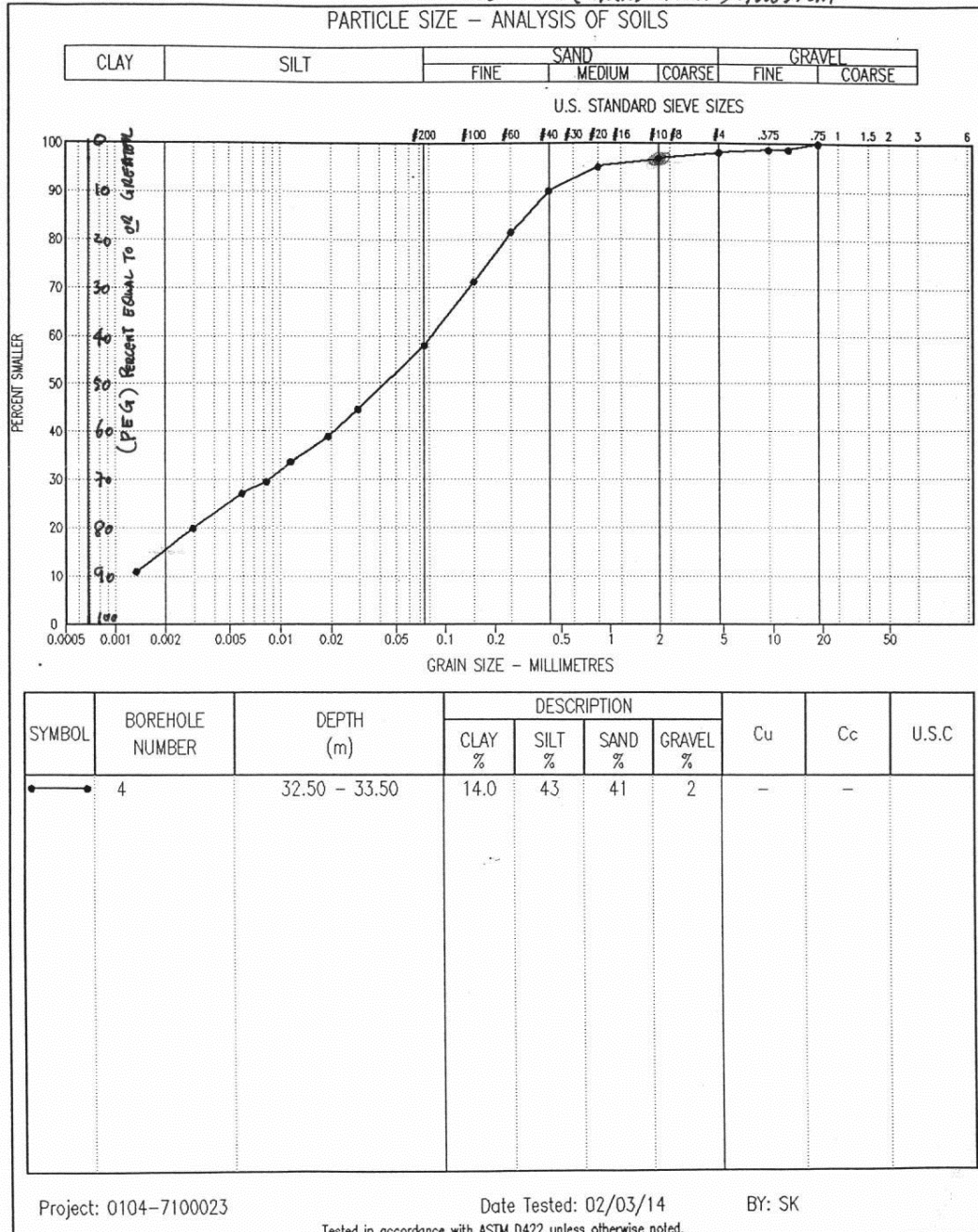

Data presented hereon is for the sole use of the stipulated client. EBA is not responsible, nor can be held liable, for use made of this report by any other party, with or without the knowledge of EBA

Tested in accordance with ASTM D422 unless otherwise noted.
The testing services reported herein have been performed by an EBA technician to recognized industry standards, unless otherwise noted. No other warranty is made. These data do not include or represent any interpretation or opinion of specification compliance or material suitability. Should engineering interpretation be required, EBA will provide it upon written request.



Figure (Example H.16c): PEG (Gradation) Assessment

Results:**Design of Sedimentation Pond (Figures 12.1, G.3a and G.4)**

- 1) Medium size silt ($D = 0.03$ mm) as design particle for settlement efficiency goal
- 2) L/W_e ratio = 7 (Figure 12.1)
- 3) Pond area = 1000 m²; flow chamber width (W_e) = 12 m; chamber length (L) – 84 m (Figure 12.1)
- 4) Earth dyke height = 1.2 m (Figure G.3a and G.4)
- (5a) Outlet berm height = 1.0 m (Figure G.3a and G.4)
- (5b) Outlet berm width (W) = 6.3 m
- 6) Outlet berm average thickness = 2 m (Figure G.4)
- 7) Outlet berm average rock size (D) 100 mm diameter
- 8) Apparent Efficiency (A_{eff}) = 92%
- 9) Net Efficiency (N_{eff}) = 50%