

Enhance Energy Inc. and North West Redwater Partnership

KNOWLEDGE
SHARING
REPORT

DIVISION B:
DETAILED REPORT
Calendar Year 2012

Submitted on:
March 28, 2013



Sun Ray Reflection, by Mathew Wong, a local Alberta painter



ACTL

**Government
of Alberta** ■



Disclaimer

NOTICE OF COPYRIGHT & PROPRIETARY RIGHTS

© 2014, North West Redwater Partnership. © 2014, Enhance Energy Inc. All rights reserved.

This document contains the information of, and is the sole property of, North West Redwater Partnership ("NWR"), Enhance Energy Inc. ("Enhance") and their respective licensors and shall not be used, reproduced, copied, disclosed, published, distributed, sold, leased, lent, altered, transmitted in any form or by any means, or otherwise exploited for any purpose other than the limited purpose(s) for which it is furnished to the Province of Alberta and in accordance with NWR's and Enhance's respective written agreements with the Province of Alberta, except with the written permission of NWR and/or Enhance, as the case may be. For greater certainty, the diagrams, flowcharts and technical descriptions included herein are for information purposes only and may not be used for any other purpose.

While reasonable efforts were undertaken so that the information contained in this document was accurate at the time of printing, neither NWR nor Enhance assume any liability for errors or omissions. Changes and corrections to the information in this document may be incorporated in future versions hereof. Except as may be otherwise expressly agreed to in writing by NWR and/or Enhance, as the case may be, the information contained in this document is provided without any express, statutory, or implied representations, warranties or conditions, all of which are hereby disclaimed, and none of the authors, NWR, Enhance or their respective licensors will be liable for any damages or liability arising from or caused by any use or reliance upon this documentation. Neither NWR nor Enhance is responsible for any modifications, additions or deletions to the original version of this documentation provided by NWR and Enhance to the Province of Alberta, unless such modifications, additions, or deletions were performed by NWR and/or Enhance as the case may be.



Certification on behalf of Enhance Energy Inc.

CERTIFIED on behalf of the Enhance Energy Inc., named in the “CCS Funding Agreement – The Alberta Carbon Trunk Line Project”, to be true, accurate and complete, to the best of my knowledge, based on reasonable inquiry and due diligence, as of the date of this certification.

This Certification applies to the information supplied by Enhance Energy Inc. only and does not imply certification of information supplied by other Recipients.

A handwritten signature in blue ink, appearing to read "SC", is written over a horizontal line.

Per: Enhance Energy Inc.

Susan Cole
President
Enhance Energy Inc.

A handwritten date "May 15/12" in blue ink is written over a horizontal line.

Date



Certification on behalf of North West Redwater Partnership

CERTIFIED on behalf of the North West Redwater Partnership, named in the "CCS Funding Agreement – The Alberta Carbon Trunk Line Project", to be true, accurate and complete, to the best of my knowledge, based on reasonable inquiry and due diligence, as of the date of this certification.

The Certification applies to the information supplied by North West Redwater Partnership only and does not imply certification of information supplied by other Recipients.

Per: 
Larry Vadori
Senior Vice President
Operations & Development

Date: May 15/2012

SECTION 1 CAPTURE		
Section 1.1 Pre-capture composition and conditioning		
Description: Boundary conditions for the capture facility must be clearly defined. Depending on the capture technology, different pre-treatment stages prior to the CO ₂ capture process are often required to adjust the temperature and/or pressure to the design conditions of the capture process and/or removing compounds that affect the performance of the capture technology.		
Purpose: To sharing the input design parameters		
Reporting Requirements:	Quantitative Data/Information	Qualitative Knowledge
During Concept and Design phase	Mass flow rate of source CO ₂ streams Expected chemical composition of source CO ₂ streams, including but not limited to: <ul style="list-style-type: none"> - CO₂ - water - ammonia - hydrogen - any other trace elements Expected source CO ₂ stream pressure and temperature. Although pre-conditioning is not initially envisioned in the Project, if conditioning is found to be necessary information related to the process shall include: <ul style="list-style-type: none"> - raw and treated gas mass flow rate - basic block flow diagram of process - gas conditioning stages and technology description - equipment dimensions and capacity 	Commentary on any changes in source stream composition

The NWR CO₂ stream does not require gas conditioning. The Agrium CO₂ stream is saturated and will undergo dehydration using a liquid desiccant such as triethylene glycol (TEG), which is the most commonly used process for such streams in the natural gas industry in Alberta.

Please refer to [Appendix i](#) for the Agrium block flow diagram

Please refer to Section 1.4 for a description of the dehydration equipment used at Agrium

Please refer to Section 1.10 for a more detailed description of the dehydration process at Agrium

Quantitative

Agrium Stream

CO₂ Agrium		
BULK PHASE	Units	
Vapor Mole Frac		1.0000
Temperature	°C	96.1
Pressure	kPag	48
Total Mole Flow	kgmole/h	2008.1
Total Mass Flow	kg/h	55,796
Volume Flow	m ³ /h	42839.6
Total Heat Flow	kW	6,735
VAPOUR PHASE		
Vapor Mole Flow	kgmole/h	2008.1
Vapor Mass Flow	kg/h	55,796
Vapor Actual Volume Flow	m ³ /h	42839.6
Vapor Std. Volume Flow	sm ³ /h	47572.3
Vapor Molecular Weight		27.79
Vapor Mass Density	kg/m ³	1.30
Vapor Viscosity	cP	0.014
Vapor Specific Heat	kJ/kg-K	1.318
Vap. Thermal Conductivity	W/m-K	0.025
Vapor Z Factor		0.9920
Vapor Cp / Cv		1.306
MOLE FRACTION VAPOUR PHASE		
Vap. CO ₂ (carbon dioxide)	%	37.72
Vap. H ₂ (hydrogen)	%	0.29
Vap. N ₂ (nitrogen)	%	0.11
Vap. H ₂ O (water)	%	61.88
Vap. C ₂ H ₆ O ₂ (ethylene glycol)	%	0.00
Vap. NH ₃ (ammonia)	%	0.00
Vapor Total	%	100.00

North West Redwater Stream

The North West Redwater Partnership (“NWRP” or “NWR”) carbon dioxide (CO₂) capture system is heavily integrated into the base design of the gasification hydrogen (H₂) supply unit. The gasification unit uses the unconverted petroleum bottoms (asphaltene) from the residual hydrocracker unit as a feedstock to produce synthesis gas (syngas). Petroleum bottoms are heavy hydrocarbons that are an unavoidable waste by-product of bitumen upgrading. The technology selected to condition the syngas is an acid gas removal process licensed from Lurgi called Rectisol[®].

Under normal operating conditions, the expected mass flow rate of captured CO₂ is 3,613 tonnes per day. A basic block flow diagram of the NWR-Enhance CO₂ capture process is shown in Figure 1.1.1. The Rectisol[®] mass balance is shown in Table 1.1.1.

Figure 1.1.1 – Basic Block Diagram of NWR-Enhance Energy CO₂ Capture Process

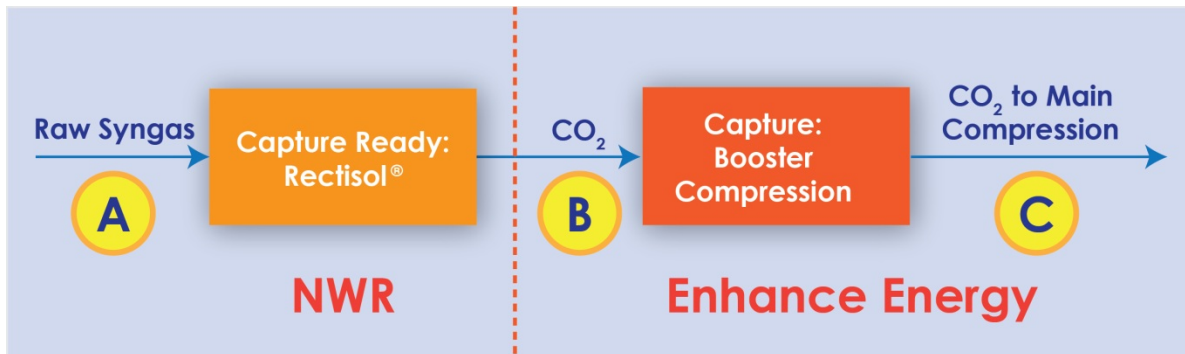

Table 1.1.1 –Mass Flow, Chemical Composition and Conditions of Source CO₂ Streams

Stream ID	A		B		C		
Description	Raw Syngas		CO ₂ to Booster Compression		CO ₂ to Main Compression		
Phase	Vapour		Vapour		Vapour		
Total flow	kmol/h	9706		3435.1		3435.1	
Total flow	kg/h	173454		150553		150553	
		Liquid	Vapour	Liquid	Vapour	Liquid	Vapour
Vol. flow	m ³ /h		-		-		-
Norm. vol. flow	Nm ³ /h	-	217552	-	76994	-	76994
Mass flow	kg/h		173454		150553		150553
Mole flow	kmol/h		9706.1		3435.1		3435.1
Mol weight	kg/kmol		17.871		43.828		43.828
Eff. density	kg/m ³		36.5		2.09		26.9
Norm. density	kg/Nm ³	-	0.797	-	1.955	-	1.955
Spec. heat cap.	J/(kg K)		1929		846		946
Viscosity	cP		0.017		0.014		0.016
Ther. conductivity	W/(m K)		0.049		0.016		0.019
Mole fraction	%		100.00		100.00		100.00
Mass fraction	%		100.00		100.00		100.00
Temperature	°C	50.00		18.25		39.73	
Pressure	kPa[g]	5365		22		1397	
Component	MW	kmol/h	mol%	kmol/h	mol%	kmol/h	mol%
H ₂	2.02	5939.5	61.194	11.1	0.322	11.1	0.322
CO	28.01	114.8	1.183	2.9	0.083	2.9	0.083
CO ₂	44.01	3520	36.266	3416.6	99.461	3416.6	99.461
CH ₄	16.04	32.7	0.337	3.7	0.106	3.7	0.106
N ₂	28.01	17.2	0.177	0.2	0.006	0.2	0.006
AR	39.95	6.6	0.068	0.2	0.005	0.2	0.005
H ₂ S	34.08	44.9	0.463	0.0	0.000	0.0	0.000
COS	60.08	0.0	0.000	0.0	0.000	0.0	0.000
NH ₃	17.03	0.0	0.000	0.0	0.000	0.0	0.000
HCN	27.03	0.1	0.001	0.0	0.000	0.0	0.000
MEOH	32.04	0.0	0.000	0.5	0.016	0.5	0.016
H ₂ O	18.02	30.1	0.310	0.0	0.000	0.0	0.000

Qualitative

Commentary Agrium Stream

There are no changes in the Agrium CO₂ stream to report on.

Commentary on NWR Stream (from Rectisol[®])

Changes in Source Stream Composition

Gasification to Produce Raw Syngas

The syngas is created in the Lurgi Multi-Purpose (MPG[®]) Gasifier reactor. This is accomplished by a non-catalytic partial oxidation of the asphaltene feedstock which is carried out at an approximate temperature and pressure of 1420 °C and 6400 kPa abs. The feedstock is routed to the reactor together with oxygen and steam where syngas is created under the following gross reactions:

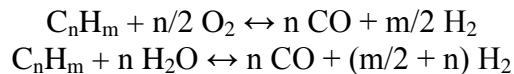

Raw Syngas Pre-Treatment

The hot syngas from the gasification reactor consists primarily of raw H₂ and carbon monoxide (CO) which is immediately cooled by direct injection of water in the Quench System. Ash and soot are then removed rendering the syngas ready for CO shift conversion.

Raw Gas Shift

The sour gas shift conversion process is based on a homogeneous water gas reaction where CO and steam are converted to CO₂ and H₂ in the presence of a catalyst according to the following exothermic equilibrium reaction:

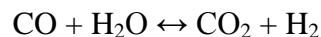

Part of the heat content recovered from the converted gas is used to pre-heat the raw gas and the remainder of the heat is removed in Gas Cooling.

Gas Cooling

The converted raw syngas is cooled by a generation of Medium Pressure (MP) steam. The resulting condensate is recycled to the process. The converted syngas is sent to the Rectisol[®] sub-unit.

Process Water Recovery

The soot slurry from the Quench System is filtered and the filtrate water is recycled and preheated before being returned to Gas Scrubbing. The produced filter cake is sent to landfill.

Rectisol[®]

The cooled raw syngas is separated into streams of H₂, CO₂ and Acid Gas (concentrated H₂S). A more detailed description of the Rectisol[®] process is provided in Section 1.4.

SECTION 1 CAPTURE		
Section 1.2 Specifications and formulation of chemicals – design		
Description:	The energy requirement of the capture process is strongly related to the performance of the solvent. Moreover, Health, Safety and Environmental (HSE) properties of solvents, and degradation products formed within the process itself, or if released to the atmosphere, is another important performance parameter for solvents. A lot of R&D work has been put into solvent development. Capture of CO ₂ is mainly achieved by either using a chemical or physical solvent. Some solvents need different types of additives in order to enhance their performance, <i>e.g.</i> , related to reaction rate (activators) or corrosivity (inhibitors). All chemicals used in the process should be described.	
Purpose:	The value of getting detailed information on this would benefit the advancement of CCS technology. Today, the major capture vendors have licensed their solvents. Knowledge of solvent compositions would also be valuable to assess lifecycle performance in terms of energy and environmental impacts of the CCS value chain. Also, HSE issues related the release of substances originating from the solvents would educate the public, and potentially increase the trust in CCS.	
Reporting Requirements:	Quantitative Data/Information	Qualitative Knowledge
During Concept and Design phase	Proposed composition of solvent. Expected CO ₂ removal efficiency. Expected solvent performance. Description of any additives to be used. Rationale for technology selection.	Design rationale Design details

Solvents will be used at the NWR plant but not the Agrium plant. Therefore the section below will only cover “specifications and formulation of chemicals” relating to the design for the NWR plant and the Rectisol[®] process.

Quantitative

Rectisol[®] is a physical absorption process carried out at low temperatures and high pressures using refrigerated methanol (CH₃OH or MEOH) as the solvent medium for physical absorption. Methanol is a liquid organic polar solvent that has significant advantages as a physical absorbent. It has strong solubility with CO₂, hydrogen sulphide (H₂S) and other undesirable trace compounds. It is highly stable and, unlike chemical solvents, its effectiveness does not deteriorate over time. Finally, it is inexpensive and supply is readily available in the Alberta Industrial Heartland.

The undesirable components of the raw syngas are physically absorbed in methanol allowing CO₂ and H₂S to be selectively removed based on differing solubility. Since the solubility of trace components such as HCN, NH₃ and sulfur compounds like mercaptans are much higher than H₂S it is possible to remove them separately using a very small solvent rate in an H₂S absorption prewash stage.

Composition of Solvent

Methanol (CH ₃ OH)	not less than 99.85 wt%
H ₂ O	max 0.1 wt%
Free HCOOH	max 15 ppm
Free Ammonia (NH ₃)	max 2 ppm
HCOH	max 20 ppm
Ethanol	max 0.01 wt%
Residue after evaporation	max 10 ppm

Expected CO₂ Removal Efficiency

The expected CO₂ removal efficiency is 97.06% as shown in Table 1.2.1. The losses remain with the other gas streams, primarily with the acid gas stream sent to the Sulphur Recovery unit.

Table 1.2.1 – CO₂ Removal Efficiency

Component	CO₂ Removal
CO ₂ Rectisol [®] Feed Rate	154,913 kg/hr
CO ₂ Capture Rate	150,362 kg/hr
CO ₂ Removal Efficiency	97.1%

Expected Solvent Performance

The Rectisol[®] process is based on the difference between the solubility of CO₂ and H₂S and other compounds in methanol, which allows for the regeneration of highly pure H₂ and CO₂ streams. This differs from the use of amine solvents, for example, which are used in chemical absorption processes. The absorption coefficient (also called the “equilibrium loading capacity”) of CO₂ in MeOH depends on the partial pressure of CO₂ and the operating temperature. For example, the absorption coefficient of CO₂ in MeOH is 10 Nm³-CO₂/m³-MeOH*bar at -20°C (e.g., 1 m³ of MeOH is needed to absorb 10 Nm³ of CO₂ at 1 bar (abs) and -20°C). Examples of absorption coefficients of CO₂ and H₂S in methanol are shown in Table 1.2.2. The process is flexible, allowing it to be tailored to a large number of selective applications.

Table 1.2.2 – Methanol Absorption Coefficients

Compound	Co-efficient (1 bar)	
	-10°C	-30°C
CO ₂	8	15
H ₂ S	41	92

As a general rule, the colder the solvent, the greater is the solubility of CO₂. The required methanol flow rate is determined by feed gas flow rate, operating pressure and temperature such that methanol flow rate decreases with:

- Lower feed gas rate
- Higher feed gas pressure

- Lower feed gas temperature

There are two forms of solvent regeneration in the Rectisol[®] process:

- Cold (Main Wash) regeneration – Methanol is recovered by using pressure reduction (flash regeneration).
- Hot (Fine Wash) regeneration – Methanol is regenerated by stripping the H₂S laden methanol in reboilers.

Because the syngas is purified with Methanol (as a physical absorption process) and there is no chemical reaction, its solvent performance does not decline over time. Methanol is recirculated for its regeneration as explained above. As Rectisol[®] is operated at very low temperatures, solvent losses with the product streams are minimized due to the very low vapor pressure. The methanol is regenerated continuously and losses are refilled every few days. Losses of approximately one tonne per day are expected at normal operation. The on-site methanol holding tank capacity is 400 m³.

Expected Energy Use for Solvent Regeneration

Solvent regeneration within the Rectisol[®] unit is expected to require 7,452 kW from external sources; 2,484 kW from medium pressure (MP) steam and 4,968 kW from low pressure steam (LP) to produce methanol vapors in the hot regeneration section. The heat input is supplied to the reboilers of the Hot Regenerator and the Methanol Water column. Further discussion of the Rectisol[®] unit energy consumption and the NWR CO₂ energy of capture is found in Section 1.5 below.

Capacity of Solvent to Recover CO₂

The solvent capacity is related to the absorption coefficient of CO₂ in MeOH. The normal rate at which CO₂ is washed and captured is 76,994 Nm³/h. The CO₂ offgas is expected to contain 99.5 mol% CO₂.

Description of Additives to be Used

Additives and catalysts are not used and do not require disposal.

Qualitative

Rationale for Technology Selection

The criteria for technology selection of the recovery process was based on the need to:

- use commercially proven technologies and vendors with low and known risks;
- integrate with the refinery processes;

- minimize CO₂ and sulphur emissions;
- minimize power and water usage;
- minimize environmental footprint; and
- minimize capital costs.

The selection of gasification technology to produce the H₂ required for upgrading and refining operations provides long-term combined operating and economic benefits to the project. Gasification provides a superior environmental solution for refining bitumen because it renders a complete destruction of the unconverted petroleum bottoms while producing useful industrial gases. It eliminates the need for delayed coking, thus averting the downstream use of petroleum coke as a combustion fuel and reduces waste disposal, land reclamation and other environmental remediation costs. These combined benefits, which endure over the full project life cycle, provide an economic alternative to conventional H₂ production and coking technologies.

The selection of the most suitable gas purification process is typically based on the specifications of the feedstock, raw syngas, and product streams. Rectisol[®] is the process of choice for chemical synthesis and is also often beneficial for other applications. The major criterion for an appropriate process selection was the requirement for an extremely high level of H₂ purity. Rectisol[®] removes all sulphur components with a guaranteed total sulphur content of less than 0.1 ppmv (equal to 100 ppbv). In addition, a pure and dry CO₂ stream with very low sulphur content is generated, suitable for urea production, beverages, carbon sequestration or atmospheric venting.

Rectisol[®] was selected above other well proven acid gas removal technologies including Amine, Selexol and Purisol for three primary reasons:

1. Chilled methanol has higher solubility than the alternatives, which means significantly less solvent is required, in turn allowing for smaller equipment, reduced energy requirements and lower costs. Other solvent advantages include no degradation, no foaming tendency, low price, good availability and, due to low operating temperatures, low solvent losses and emissions.
2. In conjunction with the selection of Lurgi as the technology vendor, it allowed for the integration of the Gasification and Rectisol[®] units in one package.
3. NWR management has direct design knowledge and operational experience with the technology.

SECTION 1 CAPTURE		
Section 1.3 Process heat integration and configuration – design		
Description:	The energy requirements of the capture process can be reduced by optimizing heat integration of unit processes and streams within the capture facility.	
Purpose:	Sharing this information could trigger increased awareness, and new ideas, of potential energy saving process integration concepts.	
Reporting Requirements:	Quantitative	Qualitative
	Data/Information	Knowledge
During Concept and Design phase	Identify all heat recovery streams (either into or out of the capture process) that are used for process heat integration. Provide a basic design flow diagram and describe the heating and cooling processes in the capture and separation processes. Stream properties (temperature, pressure, enthalpy) of these streams. Heat recovery efficiency (heat transfer or electricity generation). Solvent regeneration method (pressure swing/temperature swing configuration). Process flow diagrams.	Design rationale

Considerations regarding process heat integration and configuration in the design phase were primarily considered for the NWR plant. This is due to the fact that the CO₂ capture component at the NWR site is integrated into a new facility and thus processes could be designed at inception with optimized heat integration. For the CO₂ compression train, heat integration is not feasible because the heat value is low grade and uneconomic to recover. There is no requirement for heat integration at the Agrium plant as the CO₂ stream is currently vented from an existing plant process.

Quantitative

Heat Recovery Streams

The Rectisol[®] process streams used for heat recovery are:

- raw syngas;
- methanol;
- crude H₂;
- acid gas;
- CO₂ offgas; and
- cooling water.

A basic heat integration design flow diagram is shown in Figure 1.3.1. A general description of the heating and cooling processes of the primary Rectisol[®] sub-processes is provided in the following Section 1.4.

Stream Properties

Due to intellectual property rights the stream property measurements (e.g., temperature, pressure and enthalpy) in the Rectisol[®] heating and cooling processes are excluded.

Heat Recovery Efficiency

The Rectisol[®] process incorporates numerous heat exchangers for purposes of heat integration, refrigeration, water cooling, air cooling and MP and LP steam. The heat recovery efficiency related to heat integration of the Rectisol[®] process is 65.2% as shown in Table 1.3.1.

Table 1.3.1 Rectisol[®] Heat Recovery Efficiency

Component	CO₂ Removal
Heat Integration ^{1,3}	137,618 MJ/hr
Total Heat Duty ^{2,3}	210,944 MJ/hr
Heat Recovery Efficiency	65.2%

Notes:

- 1) Energy required to operate heat exchangers at normal operation (100% case)
- 2) Energy to operate all Rectisol[®] heat exchangers at normal operation plus net energy balance
- 3) To be updated during detailed engineering

Solvent Regeneration Method

The solvent regeneration method is Rectisol[®] or cold methanol which was described in Section 1.2.

Figure 1.3.1 – Basic Heat Integration Design Flow Diagram

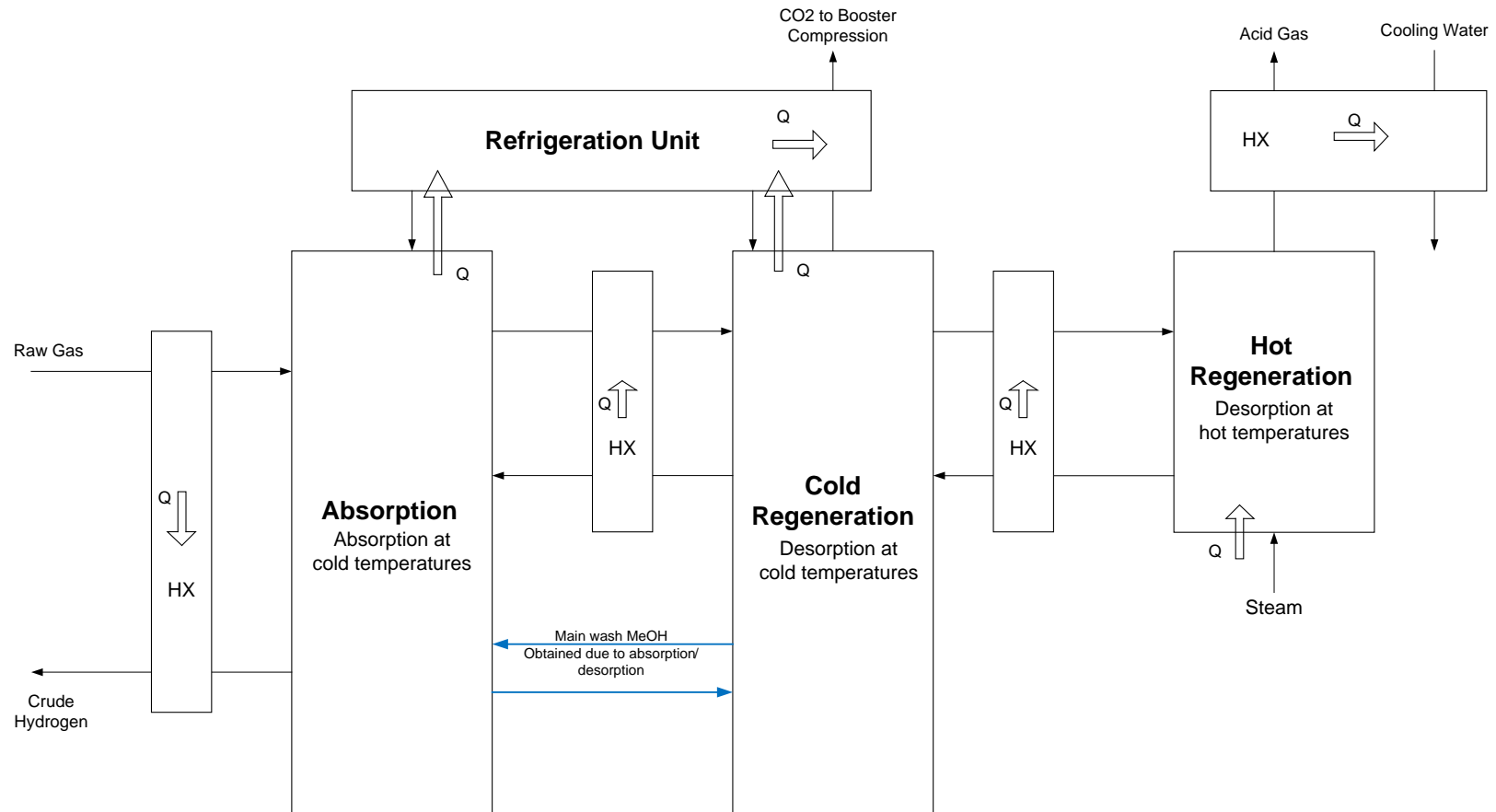

HX: Heat exchangers
 Q: Heat flux
 Steam: LP and MP steam

Rectisol® Heat Integration Design Rationale

The Rectisol® process is based on the difference between the solubility of CO₂ and H₂S in methanol. It is a highly integrated process optimized for pressure, energy and temperature and has numerous design advantages as described in Section 1.2. The high solubility of CO₂ in chilled methanol reduces the amount of solvent required, allowing for smaller equipment and lower costs.

SECTION 1 CAPTURE		
Section 1.4 Process design		
Description:	Detailed process design description of the capture, compression and dehydration facilities.	
Purpose:	This process design information enables an increased understanding of state-of-the art process design	
Reporting Requirements:	Quantitative Data/Information	Qualitative Knowledge
During Concept and Design phase	Process Block Flow Diagram for capture, compression and dehydration facilities as applicable. General description of major pieces of equipment Material balance showing process unit design capacities Show reference points for data collection, analysis and interpretation purposes.	Design rationale Updated rationale for design

Quantitative

Agrium CO₂ Recovery Facility (“Agrium CRF”)

Block Flow Diagram

For the Agrium Block Flow Diagram see *Appendix i*

Description of Major Pieces of Equipment

The Agrium process produces a hot CO₂/water vapor stream (see Appendix ii Heat and Material Balance for specifications of the stream composition). The CO₂ is recovered by cooling the hot stream with chilled glycol, separating the CO₂ stream from the condensed water in an inlet separator, compressing the stream to a pressure of 3,800 kPag [550 psig]. After compression the CO₂ is dehydrated using TEG (triethylene glycol) dehydration process. The dry CO₂ is then cooled using an ammonia refrigeration system to allow the vapor CO₂ to condense into the liquid state. Once the CO₂ is in liquid state it is pumped up to pipeline pressure using a multistage centrifugal pump. Cold liquid CO₂ is then used to pre-cool the hot, dry CO₂ gas stream from the dehydration. High pressure transfer pumps deliver the liquid CO₂ through a metering system at a pipeline inlet pressure of 17,926 kPag [2,600 psig].

The equipment required for this design is listed below.

Process Equipment

Inlet Cooling

- a) Two plate and frame inlet condensers.

Separation

- b) One carbon steel inlet separator complete with a produced water transfer pump.

Compression

- c) One six-stage electrically-driven, centrifugal, CO₂ gas compressor with, interstage scrubbers and shell and tube inter/aftercoolers that are cooled by ethylene glycol.

Dehydration

- d) One 300# ASME class, CO₂ Tri-Ethylene glycol dehydration package with all stainless steel equipment and piping equipped with a water analyzer to ensure dry CO₂ gas is routed to the refrigeration unit.

Refrigeration

- e) One 300# ASME class, carbon steel, process package to condense and liquefy the dry CO₂ stream. The process skid houses a CO₂ pre-cooler, one CO₂ Chiller, one low temperature separator and one CO₂ booster pump, one CO₂ metering package and one CO₂ transfer pump.
- f) One carbon steel refrigeration compressor package with an economizer consisting of a refrigerant/liquid CO₂ sub-cooler, lube oil separator, refrigerant suction scrubber, condenser and accumulator.

Utility Equipment

- a) One carbon steel CO₂ knock-out drum and one carbon steel CO₂ vent stack.
- b) Carbon steel produced water (“PW”) pipeline. PW is pumped from the Enhance CO₂ recovery site into the process water drain system at the Agrium site.
- c) One ethylene glycol cooling system consisting of an outdoor aerial cooler system, consisting of six bays to cool the process heat from the inlet condensers and the compressor coolers. Each bay is cooled by two fans. Process cooling system consist of a surge drum, two EG circulation pumps and a piping system.
- d) One fuel gas scrubber package to supply fuel gas for the dehydration unit and for all building heaters. Fuel gas is metered and supplied from the local natural gas distribution system.
- e) One instrument air package: two instrument air compressors, wet air receiver, instrument air dryer, particulate and moisture filters and a dry air receiver.
- f) Provision for an emergency generator to provide back-up power for asset protection from freezing in the event of an extended power outage in winter months.

Heat and Material Balance

For the Agrium Heat and Material Balance see *Appendix ii*

Measurement Schematic

For the Agrium measurement schematic see *Appendix iii*

Gasifier Process Description

As discussed in Section 1.1, the NWR CO₂ capture system is a highly integrated sub process of the Gasification unit using asphaltene as a feedstock to produce syngas. The technology selected to condition the syngas is the Rectisol[®] acid gas removal process licensed from Lurgi. The CO₂ offgas will be initially compressed within the Gasifier site at the Enhance Energy CO₂ Booster Compression Unit where it is pipelined offsite to the Enhance Energy Main Compressor Station.

The hydrocracker residue feedstock will be gasified and conditioned in the Rectisol[®] unit to produce:

- Crude H₂ for the Methanation unit to produce pure H₂ for the upgrader hydroprocessing units;
- CO₂ offgas for geological storage; and
- Acid gas (concentrated H₂S) for sulphur recovery.

The gasification unit consists of:

- Feedstock pumping;
- MPG[®] gasifier reactors where the feedstock reacts with oxygen in the presence of steam under high pressure and temperature conditions;
- Quench – superheated raw syngas is cooled by direct injection of water;
- Gas Scrubbing and Ash Recovery – ash and soot are removed;
- Raw Gas CO-Shift Conversion;
- Gas Cooling;
- Rectisol[®] – conditioning and purification of H₂, CO₂ and H₂S; and
- Methanation – further H₂ conditioning and purification.

Raw syngas is produced in the MPG[®] gasifier reactor and raw H₂ and CO₂ are produced in the CO-Shift conversion and cooled as described in Section 1.1. In the Rectisol[®] unit, H₂, CO₂ and H₂S are separated using Methanol as a solvent based on the difference between the solubility of CO₂ and H₂S in methanol. At this point the CO₂ is typically vented to the atmosphere. In the case of the North West Sturgeon Refinery, the CO₂ will be captured, compressed and transported to an injection site where it will be geologically stored.

The NWR CO₂ capture process stages can be understood as:

1. Raw syngas pre-treatment: MPG[®] Gasification, raw gas shift and gas cooling;
2. Capture Ready: Rectisol[®]; and
3. CO₂ Compression.

The process block flow diagram for the Gasification unit is shown in Figure 1.4.1.

Figure 1.4.1 – Gasifier Unit Process Block Flow Diagram

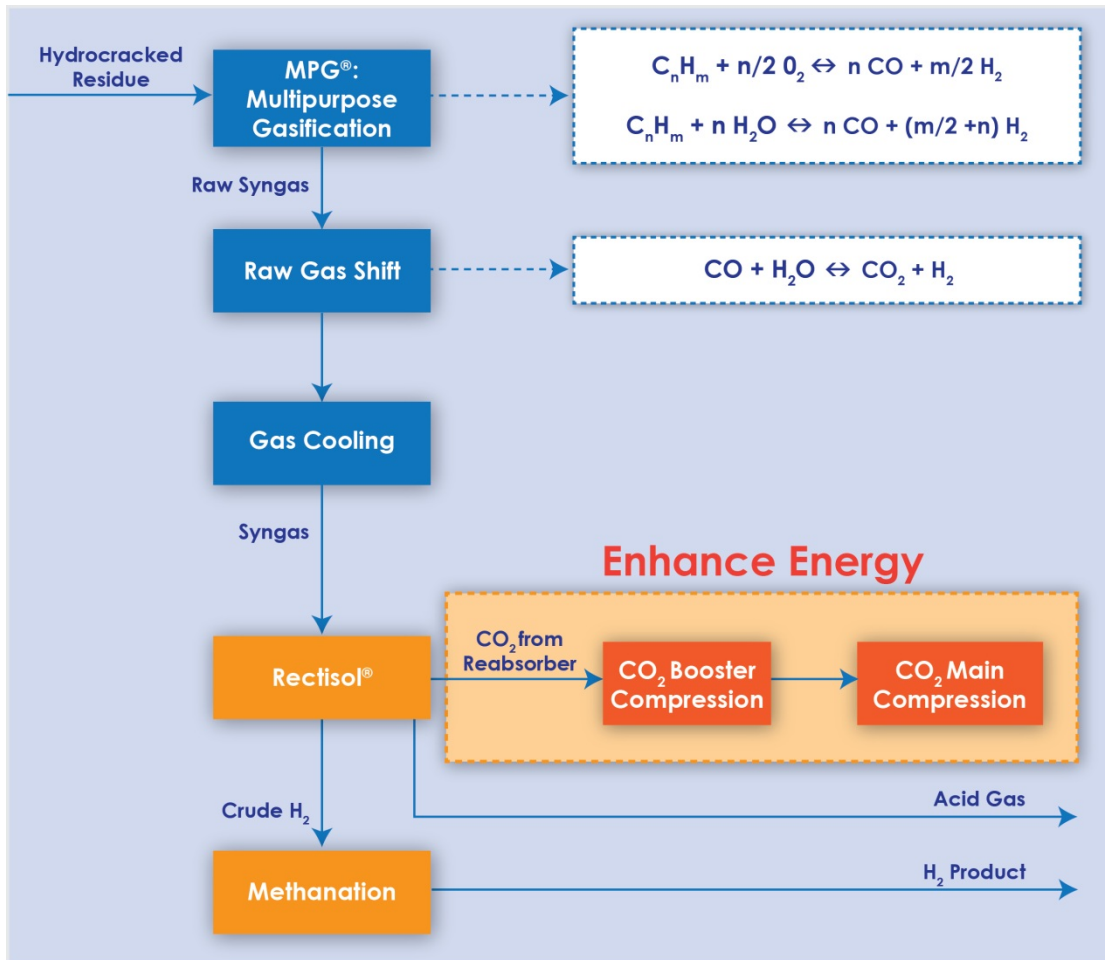

Rectisol® Process Description

The Lurgi Rectisol® unit is a licensed acid gas separation process consisting of industrial equipment in a highly integrated configuration.

Significantly less steam-heat is required for methanol solvent regeneration than with chemical solvents.

The Rectisol® equipment consists of:

1. columns and vessels;
2. compressors and pumps;
3. tanks; and
4. heat exchangers (including refrigerators and air coolers).

The primary Rectisol[®] sub-processes are:

1. Raw syngas cooling;
2. H₂S Absorption;
3. CO₂ Absorption;
4. Cold Regeneration;
5. Hot Regeneration;
6. CO₂ Off Gas Scrubbing;
7. Methanol Makeup and Recovery

While difficult to see from a simplified flow chart Rectisol[®] is a highly complex and integrated process with numerous separated syngas streams going to multiple places in order to optimize heat recovery, cooling and pressure. The process block flow diagram for the Rectisol[®] unit is shown in Figure 1.4.2. The Material balance for the Rectisol[®] unit is shown in Figure 1.5.1.

Raw Syngas Cooling

Raw syngas from the Gas Cooling Sub-unit is fed to the Rectisol[®] plant and further cooled in a series of heat exchangers against crude H₂ and propylene evaporation (refrigeration). The raw gas is then passed through a separator and the resulting condensate (water) is discharged to the process water recovery system. To prevent water freezing a small stream of methanol is injected into the raw gas. The raw syngas is further cooled against cold crude H₂ and the stream of raw gas is sent to the H₂S Absorber.

H₂S Absorption

The syngas stream passes into the pre-wash section of the H₂S Absorber, where trace components are absorbed and captured with a small stream of CO₂ laden methanol from the CO₂ Absorber. The syngas stream is routed into the main washing section of the H₂S Absorber where H₂S is scrubbed out with sub-cooled CO₂ saturated methanol from the CO₂ Absorber. CO₂ laden methanol is fed at the top of the H₂S Absorber column. The main part of the H₂S laden methanol is routed to the MP Flash Column where the pressure is dropped and H₂S and CO₂ are released. The prewash methanol from the bottom section is sent to the Hot Regenerator. The sulphur free syngas then enters the CO₂ Absorber.

CO₂ Absorption

In the CO₂ Absorber, the syngas is washed with cold, flash regenerated methanol serving as the main wash methanol and with cold, fine wash methanol that has been chilled through Hot Regeneration. After undergoing fine wash, the methanol has been heated up considerably on its way down the CO₂ Absorber column due to the physical absorption process. In the lower section of the column the syngas is scrubbed with CO₂ laden methanol. In the top of the column crude H₂ is obtained. After heat exchange with incoming raw syngas, the crude H₂ is routed to the Methanation unit.

Figure 1.4.2 – Rectisol® Unit Process Block Flow Diagram

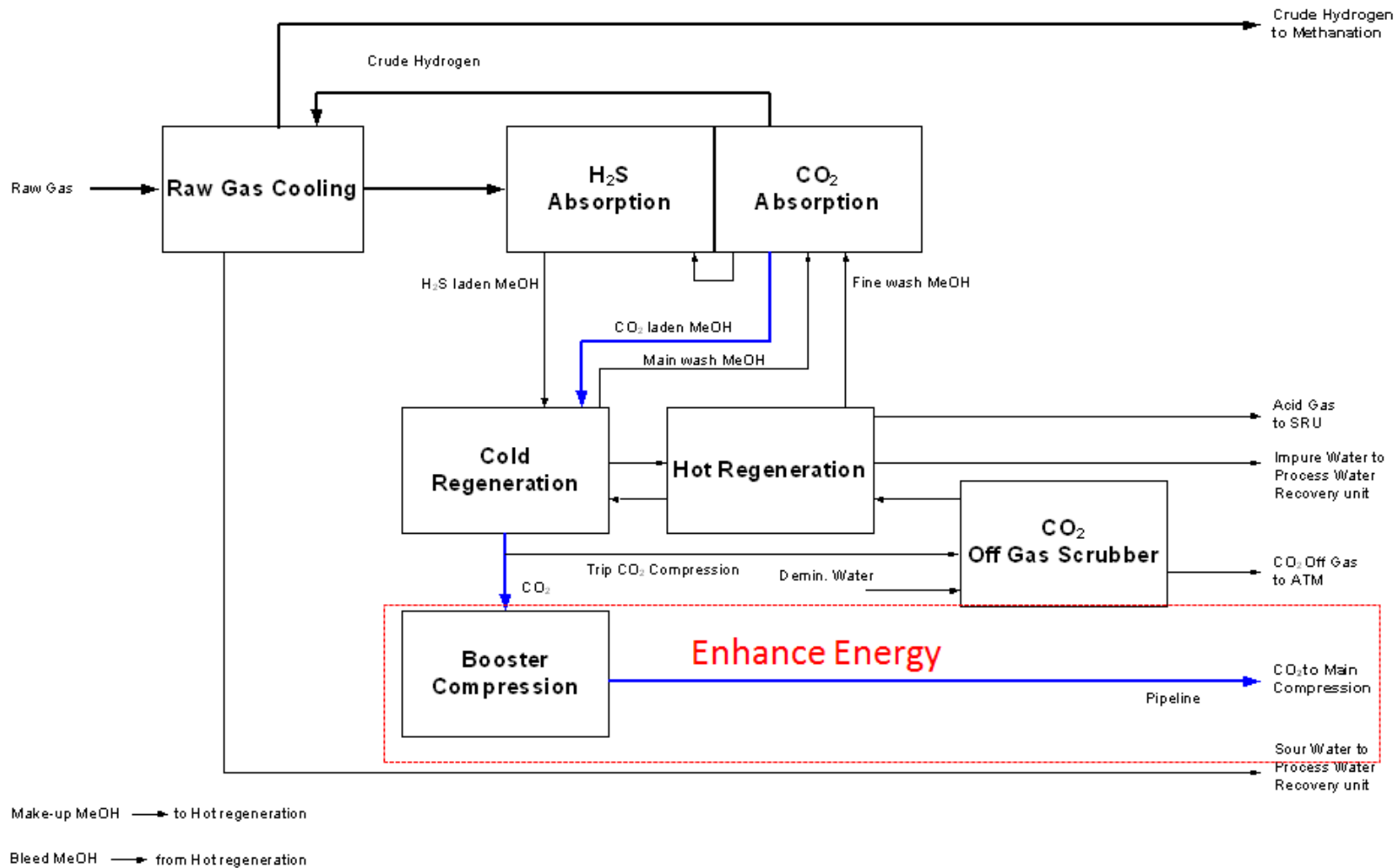

Cold Regeneration

Part of the CO₂ laden methanol from the CO₂ Absorber is routed to the top of the H₂S Absorber. The other part is diverted to the upper section of the MP Flash Column. There it is flashed, removing part of the CO₂ as well as any remaining dissolved H₂ and CO which is routed to the lower section of the column for CO₂ reduction. CO₂ laden methanol from the H₂S Absorber flows to the lower section of the MP Flash Column where the remaining H₂ and CO together with part of the CO₂ are flashed out. To lower the amount of gas to be recompressed the bulk of this flashed CO₂ is reabsorbed by a small, cold methanol stream and recompressed in a single stage. Subsequently it is cooled and recycled to the raw gas.

The CO₂ laden methanol from the upper MP Flash Column is sub-cooled and routed to the top section of the Reabsorber column, where it is flashed and highly pure CO₂ is obtained. This first stream of CO₂ off gas is reheated in the heat exchangers and routed to the Enhance CO₂ Booster Compression unit. Part of the flashed methanol is routed to the second section of the Reabsorber and the remainder is used as main wash methanol for the CO₂ Absorber. The sulphur laden methanol from the lower stage of the MP Flash Column is fed to the second section of the Reabsorber where most of the remaining CO₂ to be captured is released. This second stream of CO₂ off gas is also routed to the Enhance CO₂ Booster Compression unit.

The CO₂ off gas streams are joined together at a rate of approximately 3,613 tonnes per day and routed to the Enhance CO₂ Booster Compression unit at approximately 22 kPag and 18°C.

In the lower two sections of the Reabsorber, small amounts of highly pure CO₂ is released by flashing at vacuum conditions and routed to the vacuum compressor where it is recycled. The sulphur laden methanol stream is sent to the Hot Regeneration column.

Hot Regeneration

The sulphur-enriched methanol streams generated in the Reabsorber are fed to a hot flash at the top of the Hot Regenerator column. The released gases of the hot flash are cooled with cooling water and CO₂ off gas and fed back to the Reabsorber to enhance CO₂ recovery.

The H₂S laden methanol is hot regenerated by stripping with methanol vapors and passed through a number of heat exchangers to condense the methanol. The condensate is captured and the concentrated H₂S acid gas stream is reheated and discharged to Sulphur Recovery elsewhere in the refinery. The fully regenerated methanol is then cooled in heat exchangers and returned to the top of the CO₂ Absorber to be used as fine wash methanol. The water enriched methanol drawn off the bottom of the Hot Regeneration column is routed to the Methanol Water column. Here, the water and methanol is distilled to keep the water content in the main methanol circuits at a low level. The bottom product of this column is impure water, which is cooled and discharged to the process water recovery system.

CO₂ Off Gas Scrubbing

When the CO₂ pipeline is unable to take delivery of CO₂ offgas, the Enhance CO₂ Booster Compressor will be tripped off. During this type of upset condition, the Rectisol[®] unit is still required to continue operations and the CO₂ product streams must be immediately diverted to the CO₂ Offgas Scrubber. The scrubber uses demineralized water to reduce the methanol content of the combined CO₂ streams before venting to the atmosphere. The requirement for the CO₂ Offgas Scrubber is currently under review and may be deleted from the final design.

Methanol Makeup and Recovery

Due to continuous minor losses of methanol, a small make-up stream is provided into the Hot Regenerator column. Additionally, residual methanol is drained at several low points in the system and recycled back to the Rectisol[®] process.

Data Collection Reference Points

The syngas and CO₂ offgas are monitored continuously for surge control. Reference points for flow, pressure and temperature measurement as well as composition sampling are shown in Figure 1.4.3.

Figure 1.4.3 – CO₂ Measurement Schematic

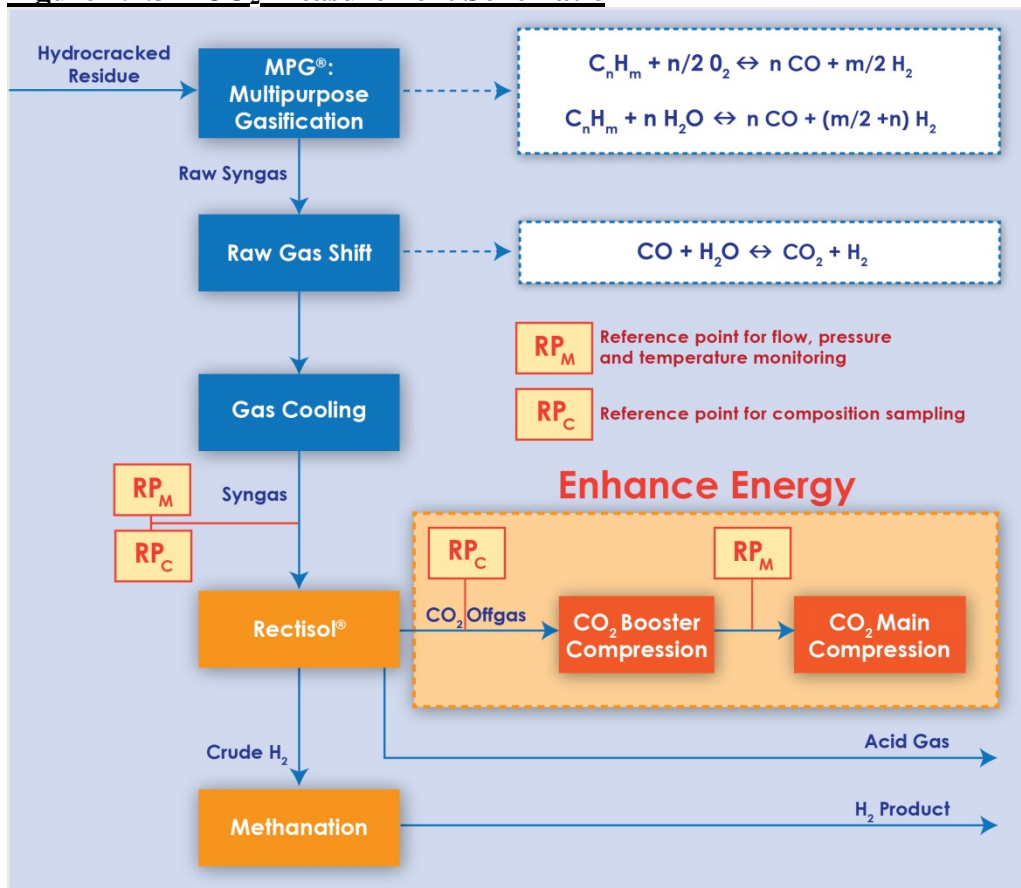

NWR CO₂ Recovery Facility (“NWR CRF”)

Enhance Energy CO₂ Booster Compression Process Description

The Enhance Energy CO₂ Booster Compression unit is part of the Enhance Energy project scope of work but it is physically located within the Gasifier unit boundary limits and is integrated into the Rectisol[®] unit design. It will be operated by NWR on behalf of Enhance Energy. At this time, the Enhance Energy CO₂ Booster Compression design process is underway. The following description is based on the design scope currently under consideration.

The Enhance Energy CO₂ Booster Compression unit is expected to be located within the north east corner of the Gasification unit boundary limit. At the inlet, the captured CO₂ conditions are expected to be approximately 22 kPag and 18 °C. The CO₂ outlet conditions at the Gasification unit boundary limit are expected to be approximately 1400 kPag and 40°C. Once compressed, the CO₂ is measured and sent to the Enhance Energy Main Compression facility where it is further compressed and transported in the Alberta Carbon Trunk Line (“ACTL”) pipeline.

The CO₂ Booster Compression unit is adjustable in a wide range of operating conditions. It will include all required equipment, instrumentation, piping and safety devices necessary for compression of the CO₂ according to the given specification, which was provided in Section 1.1.

The CO₂ Booster Compression unit will consist of the following components:

Multi-stage Compressor

The compressed CO₂ should be cooled down after each compression stage. Cooling will be done using air coolers. The design air inlet temperature for heat exchanger sizing is 34°C.

Control System

- Control valve and bypass are located in the discharge line of the compressor for anti-surge control
- Flow indicator in the suction line of the compressor
- Temperature control in every air cooler
- Level indicator in the suction drum

Enhance Energy CO₂ Main Compression Process Description

The Enhance Energy Main Compression unit will be located several kilometres away from the NWR facility. The CO₂ from the Enhance Energy Booster compressor will be pipelined to the Enhance Energy Main Compression site. The pipeline will be a low pressure line designed to minimize pressure drop between the Booster and Main compression units.

The Main Compression unit will be very similar to the Booster Compression system, as the CO₂ is dry and does not require dehydration. The compressor will be a six stage electrically driven

unit used to compress the CO₂ from 1,160 kPag (168 psig) to the ACTL pipeline pressure of 17,926 kPag (2,600 psig). The compressor will be designed to operate over as large a capacity range as possible. Its best efficiency point will be 3,500 tonnes per day, and it will have the capability to compress up to 4,200 tonnes a day.

The CO₂ will be cooled between compression stages by air cooled exchangers. By removing the heat generated during the compression stage, this cooling stage ensures maximum compression efficiency. The air cooled exchangers will be designed to operate in the variable seasonal conditions that exist in the Fort Saskatchewan region.

The CO₂ Main Compression unit will consist of the following components:

Multi-stage Compressor

The compressor will be in six stages and is driven by a directly coupled electrical motor. The compressor type and model have not been finalized.

Air Cooler

The compressed CO₂ should be cooled down after each compression stage. Cooling will be done using air coolers.

Control System

The control system is comprised of two main components:

- A control valve and bypass, located in the discharge line of the compressor for anti-surge control; and
- Temperature control, located in each air cooler.

Qualitative

Agrium CRF

The design basis for the new Agrium Capture facility is for economic recovery of CO₂ from the fertilizer CO₂ emission streams. The streams pass through inlet cooling, separation, compression, dehydration, and refrigeration. These processes produce liquefied CO₂ that is then pumped into the ACTL at a pressure of 17,926 kPag (2,600 psig).

The design was created in this manner so as to recover the highest percentage of CO₂ from the incoming feed stream. Various process options were discussed before arriving at the proposed process design. This current design utilizes a “fit for purpose” philosophy by incorporating typical oilfield/industrial technology, sourced and serviced locally.

NWR Rectisol[®]

Rectisol[®] Process Design Rationale

As shown in Figure 1.4.4, Rectisol[®] accomplishes in one step several tasks that are usually necessary in conventional gas treatment set-ups, eliminating the need for separate process steps:

1. Complete Purification – Rectisol[®] directly delivers syngas qualities with extremely low total sulphur content eliminating the need for further gas purification. Removal of all sulfur components including H₂S, COS, mercaptans, down to 0.1 ppmv (100 ppbv) can be guaranteed.
2. Trace Contaminant Removal – A key advantage of the Rectisol[®] process is the complete removal of trace contaminants contained in the raw gas from the gasification unit, such as COS, HCN, NH₃, mercaptans, mercury, Fe- and Ni-carbonyls, and BTXs. Because the COS is removed together with the H₂S, the need for a COS hydrolysis reactor upstream of a Rectisol[®] unit is eliminated.
3. Dry CO₂ – Since the CO₂ offgas is completely dry there is no need for additional dehydration.
4. Sulphur Recovery – Rectisol[®] produces H₂S-rich acid gases even from raw gases with very high CO₂ to H₂S ratios, typically found in post-CO shift units.
5. Low Energy – Rectisol[®] is especially well suited for the economical removal of bulk CO₂ and carbon capture and storage. Due to the physical nature of the absorption process, the energy required to remove large amounts of CO₂ depends only on the total gas flow and gas pressure but not on the CO₂ concentration in the feed gas.

Figure 1.4.4 – Advantages of Rectisol[®] Acid Gas Purification and Conditioning

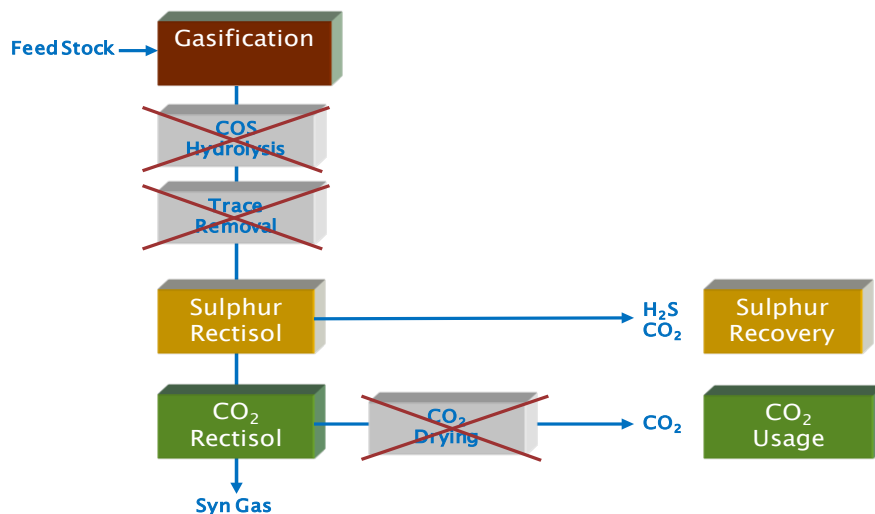

NWR CRF

The design basis for the new NWR Capture facility is structured around the economic recovery of CO₂ from the Rectisol[®] process. The CO₂ stream is capture ready, so no additional processing other than compression is required to deliver it into the ACTL for transportation. The compression process and technology used at the NWR CRF have been employed in industries worldwide and were recently used for a similar project in southern Saskatchewan.

The compression process was split into a booster and main compressor to allow easy integration into the NWR refinery. Space is always a constraint inside industrial facilities, and the footprint required for CO₂ compression is very large, mainly due to the size of the air coolers. The booster was designed to minimize the footprint within the Rectisol[®] unit boundaries, and to allow for

effective transportation via a low pressure pipeline to the main compression unit, located a few kilometers from the North West Sturgeon Refinery property.

The additional stages and cooling located within the Enhance Energy Main Compression site are easily accommodated as the site is specifically designed to compress CO₂. This allows for “Fit for Purpose” design for the CO₂ compression unit, and for future equipment sparing and integration of other potential CO₂ volumes.

With the compression requirements split between the booster and main compressor units, the electrical requirements for starting and operating are easier to integrate into the electrical infrastructure in the Alberta Industrial Heartland area.

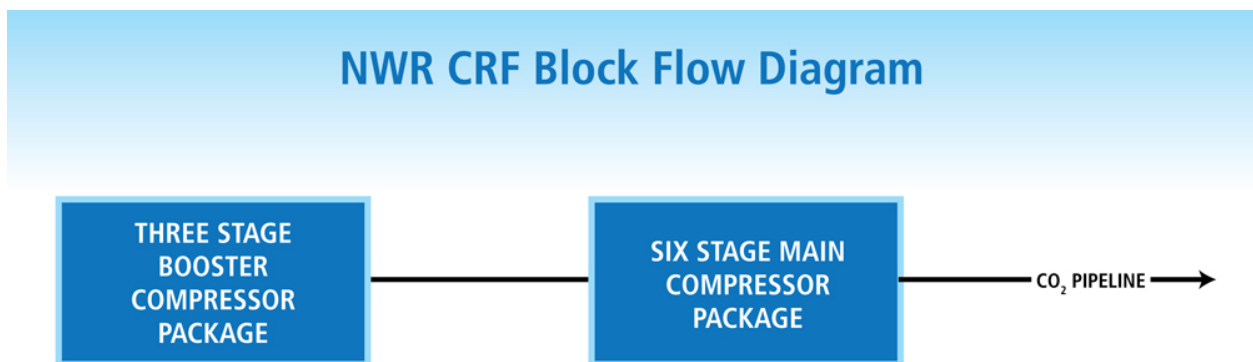

SECTION 1 CAPTURE		
Section 1.5 Energy consumption (energy penalty of capture) - performance		
Description:	The boundaries for the energy balance will be submitted based on the Project Plan and an overall figure for the energy of capture should be reported as MJ/kg of CO ₂ captured.	
Purpose:	There is a lack of real data for energy consumption, and information would be valuable for benchmarking performance and as a driver for developing more energy efficient processes. The energy balance is a useful comparison to other process approaches for CO ₂ capture.	
Reporting Requirements:	Quantitative Data/Information	Qualitative Knowledge
Before Operation	Estimates of energy of capture expressed as MJ/kg of CO ₂ captured. Mass and energy balance as provided in PFD	Benchmarking estimate

Quantitative

Estimate of energy of capture expressed as MJ/kg of CO₂ captured

Enhance (Agrium CRF and NWR CRF)

The following table highlight Enhance's estimates for the energy of capture. As the project is still in its design phase only estimates, and not actual energy used, can be reported at this point.

Facility	Energy of Capture	Units
Agrium CRF - Energy Consumption	0.60	MJ/kg CO ₂
Enhance Booster Compressor- Energy Consumption	0.25	MJ/kg CO ₂
Enhance Main Compressor - Energy Consumption	0.16	MJ/kg CO ₂

Mass and energy balance

The mass and energy balance for Agrium can be found in [Appendix ii](#)

NWR Rectisol[®] **Rectisol[®] Unit**

The energy footprint of the Rectisol[®] unit is allocated to production of H₂ and is outside the energy for capture boundary.

Figure 1.5.1 – Rectisol® Process Block Flow Diagram including Mass Balance

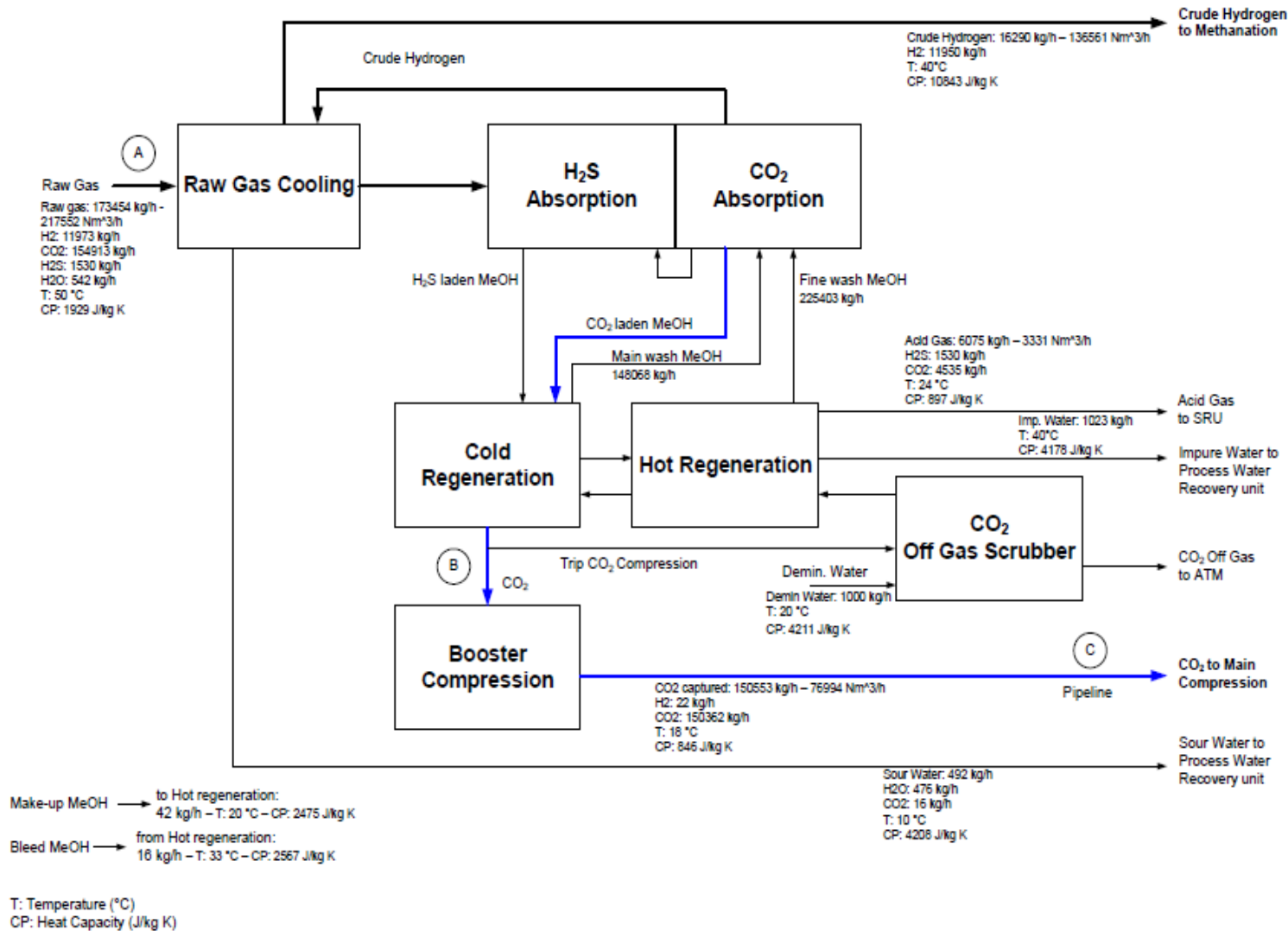

SECTION 1 CAPTURE		
Section 1.6 CO₂ capture ratio - performance		
Description:	The performance of the process in terms of amount of CO ₂ captured should be reported by reference to the CO ₂ capture ratio, which is defined as the fraction of the formed CO ₂ which is captured, on an annual basis, taking the availability of the plant into account.	
Purpose:	This is valuable for the purpose of benchmarking technologies.	
Reporting Requirements:	Quantitative Data/Information	Qualitative Knowledge
Before Operation	Estimates on the fraction of the formed CO ₂ which is captured, on an annual basis. Provide an overview of the design basis and mass and energy balance.	Benchmarking estimate

Quantitative

Agrium CRF

CO₂ capture ratio metrics do not apply to the fraction of formed CO₂ from the Agrium process. The Agrium process does not use an additional process to separate the CO₂ from their main fertilizer process, as the CO₂ is a by-product that is presently being vented to the atmosphere. The CO₂ that is produced at the Agrium facility is a by-product of the fertilizer manufacture process, and this process emits a wet, pure CO₂ stream. The CO₂ emitted from the process is compressed and dehydrated for transportation in the ACTL pipeline with no additional capture technology being used.

The CO₂ capture ratio for the Agrium CO₂ stream is strictly a function of overall plant availability. The anticipated plant availability is 99%, therefore the anticipated CO₂ capture ratio is 99%.

Refer to [Appendix ii](#) for the mass and energy balance

NWR CRF

CO₂ capture ratio metrics applying to the fraction of formed CO₂ that is captured during the Rectisol[®] process is discussed below.

The CO₂ capture ratio for the NWR CRF will be a function of the fraction of formed CO₂ and plant availability. The anticipated plant availability (both the Booster and Main compression) is 99%, and the CO₂ removal efficiency of the Rectisol[®] is 97.1%. Therefore the overall capture ratio is expected to be 96%.

Refer to Section 1.1 for the mass balance.

Refer to Section 1.4 for an overview of the design basis.

Refer to Section 1.5 for the energy balance.

Qualitative

Benchmarking Estimate

The benchmarking estimate for the CO₂ capture ratio is 99% for the Agrium CRF.

The benchmarking estimate for the CO₂ capture ratio is 96% for the NWR CRF CO₂ stream.

SECTION 1 CAPTURE		
Section 1.7 Reliability - performance		
Description:	The reliability of the capture process and operational interference with the base facility is important information. Downtime information should be given for all relevant components affecting the overall reliability of the capture facility.	
Purpose:	Reliability data should be provided to inform relevant stakeholders of the operational risks caused by CO ₂ capture. The information provided will be completed at a detailed level, in order to provide failure rate data on a process unit level. This will enable new projects to optimize their selection of facilities, systems, and equipment. It will also help with risk analyses or maintenance and spare-parts planning.	
Reporting Requirements:	Quantitative Data/Information	Qualitative Knowledge
Before Operation	Estimated annual availability for process units Availability should be based on planned operational downtime.	Rationale for estimated availability Summary of lessons learned from operational experience

Quantitative

Agrium CRF

Estimated annual availability for process units

The estimated annual availability for the process units are listed below:

Process Units	Availability – first year of Operation	Availability – subsequent years
Inlet Area/Separation	95%	98%
Compression	95%	98%
Dehydration	95%	98%
Refrigeration / Pumping / Metering	95%	98%

The reduced availability in year one takes into account startup/commissioning activities, process upsets, testing, tuning and other miscellaneous process interruptions. After this initial year of operation, availability will improve as the process is streamlined.

NWR Rectisol[®]

It is estimated the gasifier will not be in service due to planned turnaround and other operational downtime within the refinery for on average of 27 days each year. Because the refinery will operate on a four year cycle of planned turnarounds, the expected planned availability will vary significantly from year to year. Therefore the planned average availability is 92.6% over a four

cycle. As discussed in Section 1.6, CO₂ is not formed when the Gasifier is not in service, therefore refinery downtime will not result in increased CO₂ emissions.

The estimated operational reliability of the Gasifier unit is 98.8% exclusive of planned maintenance.

NWR CRF

Estimated annual availability for process units

The estimated annual availability for the process units are listed below:

Process Units	Availability – first year of Operation	Availability – subsequent years
Compression (Booster and Main)	95%	98%

The reduced availability in year one takes into account startup/commissioning activities, process upsets, testing, tuning and other miscellaneous process interruptions. After this initial year of operation, availability will improve as the process is streamlined.

Qualitative

Agrium CRF

Rationale for estimated availability

The Agrium CRF, with its related ancillary equipment, is designed to operate as a remote, unmanned facility. The design was further centred around ensuring high quality material standards, smoothly integrating process design, and following strict design standards as dictated by applicable ABSA, CSA and ANSI.

The compressor is a critical component of the process. Accordingly, a centrifugal compressor was chosen over a reciprocating compressor as it offers superior efficiency, oilfree compression, operates at higher speeds and requires less maintenance leading to longer intervals between major servicing. Additionally, the unit is manufactured to applicable API 617 standards to ensure rugged and reliable operation.

The site layout and modular design of the facility provides for ease of access to critical components in each of the units. This ensures accessibility for maintenance, repairs, and safety in an effort to extend the mean time between failures.

The control system is comprised of two components: Basic Process Control System (“BPCS”) and metering/measurement (“MMS”). The BPCS will oversee the process control and safety needs of the facility, mitigating releases to the environment and maintaining the integrity of equipment assets and infrastructure. The MMS will take care of plant balance, measurement and ERCB reporting functions.

The BPCS and MMS components of the control system are to support an un-manned philosophy with a desired on-line in-service availability of 99.98%. BPCS and MMS are designed so that monitoring and control functions can be conducted both locally at the facility by field operations and remotely at designated distant remote locations. Remote locations will include Calgary corporate head office, other Enhance offices, field technician service laptops using wireless interface, field support technician workstations located at their home residence(s) and approved third party entities as determined by Enhance. BPCS and MMS product platforms will be selected to support close integration of platforms so that data exchange between systems is readily achievable.

The control system will be built using product platform(s) that have proven to be acceptable by other local industry owners, are readily available in the local marketplace and have demonstrated to be reliable in similar industry applications. A key selection criterion is availability of skilled technical workforce resources that have sufficient training and experience to locally support the operational life phase once the system is installed, commissioned and fully deployed by the Enhance.

The MMS will be designed with products and technologies that meet “Custody Transfer” specifications as required by ERCB and Measurement Canada as well as the principles defined in ERCB’s EPAP publication.

NWR Rectisol[®] **Benchmark Estimate**

The estimated benchmark for planned average availability is 92.6% over a four year cycle.

Outage Scenarios

Three operating scenarios that result in full or partial curtailment of CO₂ deliveries and which may result in increased CO₂ emissions to the atmosphere have been identified:

Scenario 1 –Enhance Energy CO₂ Booster Compression Trip

In the event of a curtailment of storage activities, the Enhance Energy CO₂ Booster Compression unit will trip off or reduce throughput and all or part of the CO₂ offgas will be vented to the atmosphere for the duration of the outage. In this scenario, the CO₂ capture ratio is directly impacted.

Scenario 2 – Rectisol[®] unit outage

In the event of an unplanned Rectisol[®] outage and depending on the type of outage, CO₂ may be sent to the Enhance Energy CO₂ Booster Compression unit at a reduced rate. In this scenario, the CO₂ capture ratio is directly impacted.

Scenario 3 – Gasifier or Methanation unit outage

In the event of a gasifier outage, production of syngas will shut down, the syngas in the system will be reduced and the CO₂ emitted is expected to be inconsequential. If the Methanation unit trips off, CO₂ may be sent to the Enhance Energy CO₂ Booster Compression unit at a reduced rate, and the CO₂ emitted is expected to be inconsequential. In this scenario, there is no impact to the CO₂ capture ratio.

NWR CRF

Rationale for estimated availability

The rationale for both the booster and main compressors within the NWR CRF is essentially the same. The NWR CRF, with its related ancillary equipment, was designed to be operated as a remote, unmanned facility. The design was further centred around ensuring high quality material standards, smoothly integrating process design, and following strict design standards as dictated by applicable ABSA, CSA and ANSI.

The compressors are critical components of the process. With respect to the main compressor site, a centrifugal compressor was chosen over a reciprocating compressor as it offers superior efficiency, oil free compression, operates at higher speeds and requires less maintenance leading to longer intervals between major servicing. Additionally, the unit is manufactured according to applicable API 617 standards to ensure rugged and reliable operation.

The site layout and modular design of the facility provides for ease of access to critical components in each of the units. This ensures accessibility for maintenance, repairs, and safety in an effort to extend the mean time between failures.

The control system is comprised of two components: Basic Process Control System (“BPCS”) and metering/measurement (“MMS”). The BPCS will oversee the process control and safety needs of the facility, mitigating releases to the environment and maintaining the integrity of equipment assets and infrastructure. The MMS will take care of plant balance, measurement and ERCB reporting functions.

The BPCS and MMS components of the control system are to support an un-manned philosophy with a desired on-line in-service availability of 99.98%. BPCS and MMS are designed so that monitoring and control functions can be conducted both locally at the facility by field operations and remotely at designated distant remote locations. Remote locations will include Calgary corporate head office, other Enhance offices, field technician service laptops using wireless interface, field support technician workstations located at their home residence(s) and approved third party entities as determined by Enhance. BPCS and MMS product platforms will be selected to support close integration of platforms so that data exchange between systems is readily achievable.

The control system will be built using product platform(s) that have proven to be acceptable by other local industry owners, are readily available in the local marketplace and have demonstrated to be reliable in similar industry applications. A key selection criterion is availability of skilled

technical workforce resources that have sufficient training and experience to locally support the operational life phase once the system is installed, commissioned and fully deployed by Enhance.

The MMS will be designed with products and technologies that meet “Custody Transfer” specifications as required by ERCB and Measurement Canada as well as the principles defined in ERCB’s EPAP publication.

SECTION 1 CAPTURE		
Section 1.8 Emissions to air, soil or water - performance		
Description:	All regulated emissions (non-CO ₂), to air, soil and water caused by the introduction of the CO ₂ capture process should be identified and reported, with identification of the ultimate waste products. Any substances that might have harmful environmental or HSE effects if released to atmosphere should be identified.	
Purpose:	Providing this information may allow technology developers to know the emissions from a process, in order to focus on developing improved new processes, from both a HSE and cost perspective, and to provide valuable information to other project developers that are considering different methods for waste handling.	
Reporting Requirements:	Quantitative	Qualitative
	Data/Information	Knowledge
Before Operation	<p>Expected emissions to be included in mass and energy balances</p> <p>Estimated quantities of non-CO₂ emissions to air, soil and water (ppm) including, but not limited to:</p> <ul style="list-style-type: none"> - emissions off the dehydration processes - water disposal extracted from dehydration, - any emissions that were unexpected will be reported 	<p>Identify substances that may have environmental or HSE effects</p> <p>Report properties and potential consequences of emissions from capture facility</p> <p>Report summarizing emissions and potential negative consequences for the environment</p>

Quantitative

Agrium CRF

Expected emissions to be included in mass and energy balances¹

Non-Condensable vapour off the LTS	Volume	Unit	Volume	Unit	As % of total ACTL capture volume
Std Volume Flow	0.01	MMSCFD	-	tCO ₂ /d	-
Std Volume	0.2	10 ³ m ³ /d	-	tCO ₂ /d	-
Molefrac CO ₂	75.7%	Mole %	0.079739136	tCO ₂ /d	0.19%
Molefrac H ₂	21.3%	Mole %	0.0010281	tCO ₂ /d	0.00%
Molefrac N ₂	2.8%	Mole %	0.001888012	tCO ₂ /d	0.00%
Molefrac O ₂	0.16%	Mole %	0.000122544	tCO ₂ /d	0.00%

¹ Specific Gravity conversion information – http://www.engineeringtoolbox.com/specific-gravities-gases-d_334.html

Emissions off the dehydration processes

The emissions from the combustion of natural gas in the dehydration process are estimated to be 580 tonnes CO_{2e} a year.

Quantities Water disposal extracted from dehydration

The moisture extracted from the dehydration process is directed to the inlet knockout drum. All the produced water from the CO₂ stream is pumped back to the source plant for disposal.

Produced Water

The following table details the amounts of produced water from the process:

	Flow Rate kg/hr	% Total
Carrier Pipe KO Pot	0	0
Inlet Area / Separation	21,422	95.6
Compression	951	4.2
Dehydration	39	0.20
Refrigeration / Metering / Pumping	0	0
	22,412	100

The volumes shown above are extracted from the facility Heat and Material Balance, assuming typical operating conditions. In very cold weather, some condensing would be expected to collect in the carrier pipe knock out pot, thus reducing the loading on the inlet condensers. But the overall volumes would remain the same. The water extracted from the various steps of the overall dehydration process is directed to the inlet knockout drum. All the produced water from the CO₂ stream is pumped back to the source plant for disposal. The inlet knockout drum is not vented to atmosphere as it connected to the suction side of the CO₂ compressor, thus there are no emissions to the atmosphere in this process.

The analysis depicting the quality of the produced water can be found in [Appendix v](#). This water will be directed back to the Agrium processing facility to be blended with their process water stream. In the future, it is contemplated that this water may be further treated to improve the quality enough to find an additional use or directed to a disposal well.

Any unexpected emissions

At this point, there are no unexpected emissions that need to be reported.

NWR Rectisol[®]

Air Emissions

Under normal operating conditions there are no air emissions from the Rectisol[®] unit and Enhance Energy CO₂ Booster Compression unit as shown in Table 1.8.1.

Table 1.8.1 – Contribution to Regional Criteria Air Contaminants

Emissions Source (tonnes/day)	SO ₂ (t/d)	NO _x (t/d)	CO (t/d)	PM _{2.5}
Rectisol [®]	0.00	0.00	0.00 ¹	0.00

In the case of a CO₂ compression trip, the CO₂ offgas is vented to the atmosphere. In this backup scenario the expected air emissions (100 % case) are as shown in table 1.8.2.

Table 1.8.2 – Expected Non-CO₂ Air emissions in Event of CO₂ Compression Trip

Emissions Source	CO (t/d)	CH ₄ (t/d)	H ₂ (t/d)	MeOH (ppm v)	H ₂ S (ppm v)
Rectisol [®]	1.9	1.4	0.5	8	1

Soils Emissions

The Rectisol[®] unit has no soils emissions. Topsoil will be stripped, salvaged and stockpiled in a stable location prior to development. Appropriate erosion control measures, including vegetative cover on soil stockpiles, will be implemented to prevent wind and water erosion. Subsoil compaction may occur during construction and operation of the project. However, the impacts are localized and reversible through reclamation. In the event of an unplanned chemical release, spill response, containment and remediation measures will ensure that impacts on the sub-soil resource are localized and reversible.

Water Emissions

The Rectisol[®] unit has no water emissions. The impure water and sour water process streams are sent to the Gasifier's process water recovery unit and are either reused in the Gasifier's Gas Cooling unit or sent to the Refinery's Water Treatment unit.

NWR CRF

There are no emissions from the NWR CRF Booster or Main facility other than fugitive emissions from fittings and connections. These emissions will be calculated once the detailed engineering design has been completed.

Qualitative

Identify substances that may have environmental or HSE effects

There are no substances emitted from the Project's capture process that may have environmental or HSE effects.

Report properties and potential consequences of emissions from capture facility

Since there are no harmful substances emitted from the process, there exist no properties of such substances, nor are there potential consequences to be disclosed.

Report summarizing emissions and potential negative consequences for the environment

During normal operation, the only emissions from the Agrium CRF and NWR CRF will be minute quantities of non-condensable vapours that are generated in the CO₂ liquefaction. These impurities originate in the process areas of the fertilizer plant from which the CO₂ stream was captured. As shown in the heat and material balance, this vent stream off the Low Temperature Separator is mainly comprised of Hydrogen, Nitrogen, and Oxygen that will be dispersed with a small stream of CO₂. The CO₂ is used to dilute these compounds and provide a means of dispersion out the vent stack.

SECTION 1 CAPTURE		
Section 1.9 Land Use – Plot Plan		
Description:	The footprint of the capture facility will determine the feasibility of the capture concepts for “brown field” projects, where there is limited available space. Information on typical layout and land use, taking the utility requirements into account.	
Purpose:	This will provide valuable information for other CCS project developers. The plot plan will provide valuable information with respect to the total footprint of the capture process	
Reporting Requirements:	Quantitative Data/Information	Qualitative Knowledge
During Concept and Design phase	A plot plan should include: <ul style="list-style-type: none"> - identification of all process units - identification of all access roads - general piping layout - placement of CO₂ export system (compressors, etc.) - site dimensions 	

Agrium CRF

The plot plan for Agrium CRF can be found in *Appendix vi*

Site Dimensions

The Agrium CRF site is 150 meters by 100 meters.

NWR Rectisol[®]

A plot plan of the NWR Refinery showing access roads and the placement of the CO₂ discharge piping is provided in Figure 1.9.1. A plot plan of the Gasifier unit showing the CO₂ piping layout within the Rectisol[®] unit is provided in Figure 1.9.2. Additional 3-D views of the Gasifier and Rectisol[®] units showing the location of major sub-process units and general piping layouts are provided in Figure 1.9.3, Figure 1.9.4, Figure 1.9.5 and Figure 1.9.6.

Space Requirements

The area required for the Rectisol[®] unit and the Enhance Energy CO₂ Booster Compression unit is approximately 1.4 hectares (3.5 acres).

NWR CRF

The Enhance Energy CO₂ Booster Compression unit is provided in Figure 1.9.2. The plot plan for NWR CRF Main Compressor has not yet been finalized.

Figure 1.9.1 – NWR Sturgeon Refinery Plot Plan

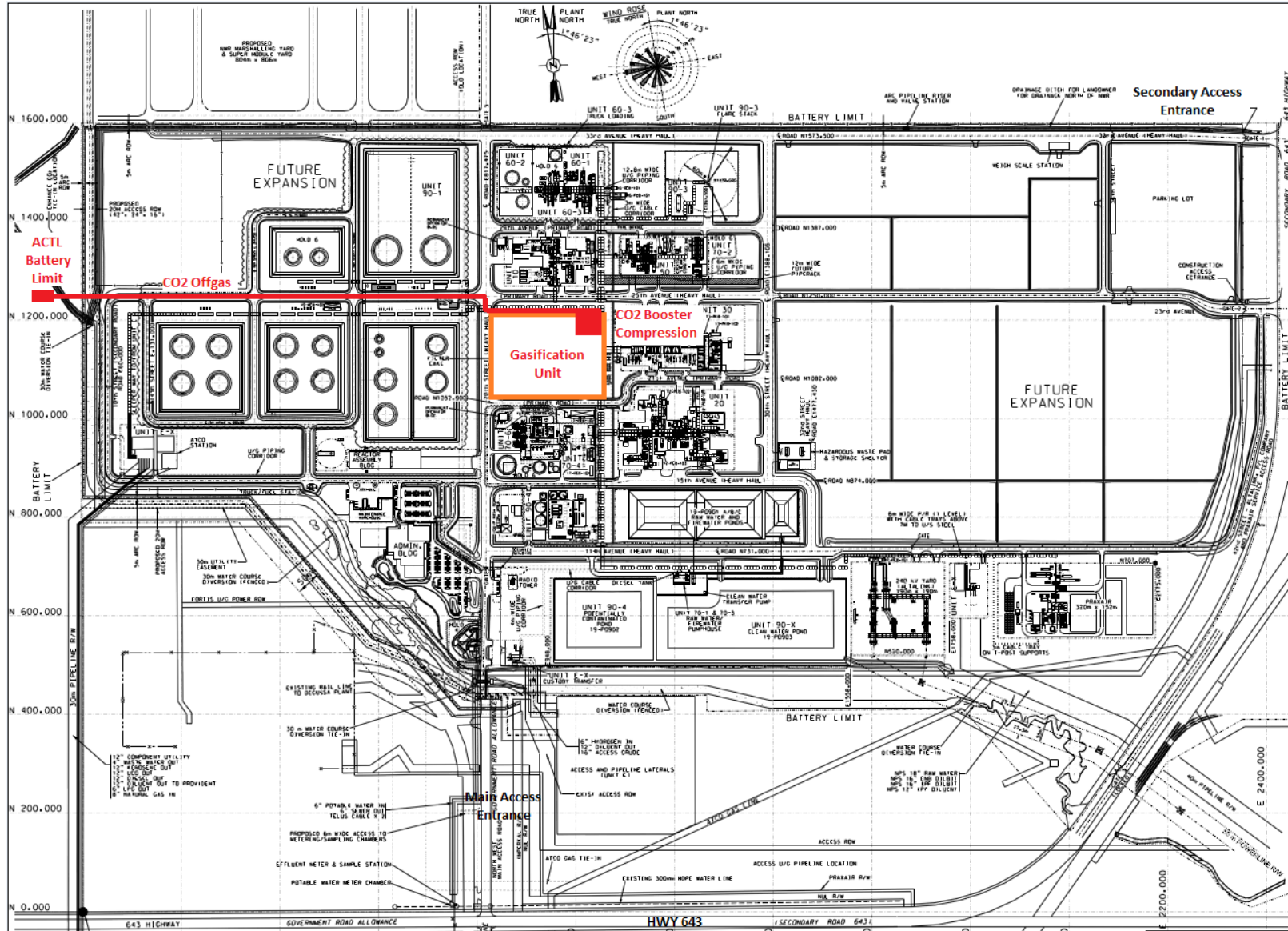

Figure 1.9.2 – Gasifier Unit Plot Plan

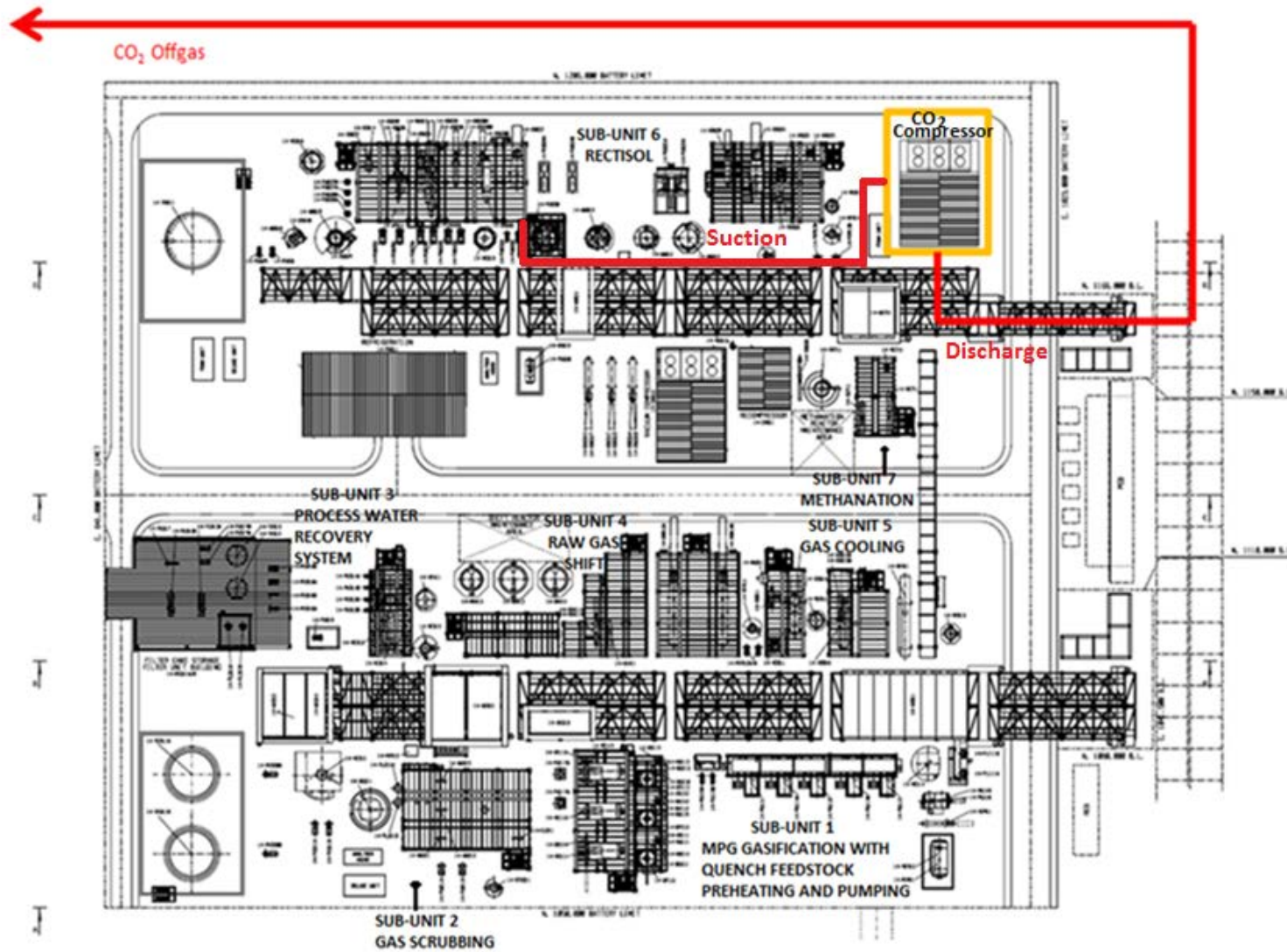

Figure 1.9.3 – Gasifier Unit 3D Plan View

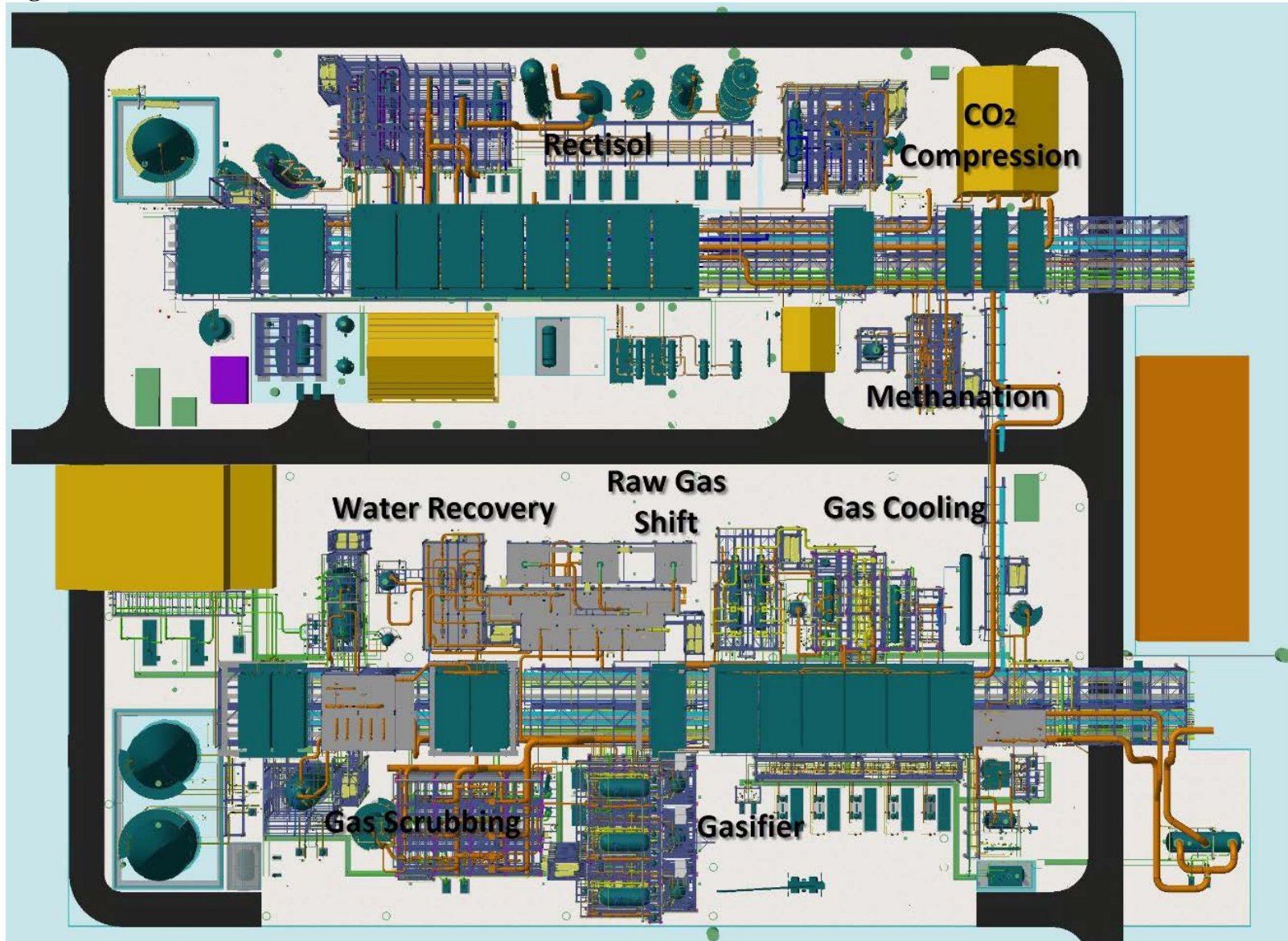

Figure 1.9.4 – Gasifier Unit – 3D NW View

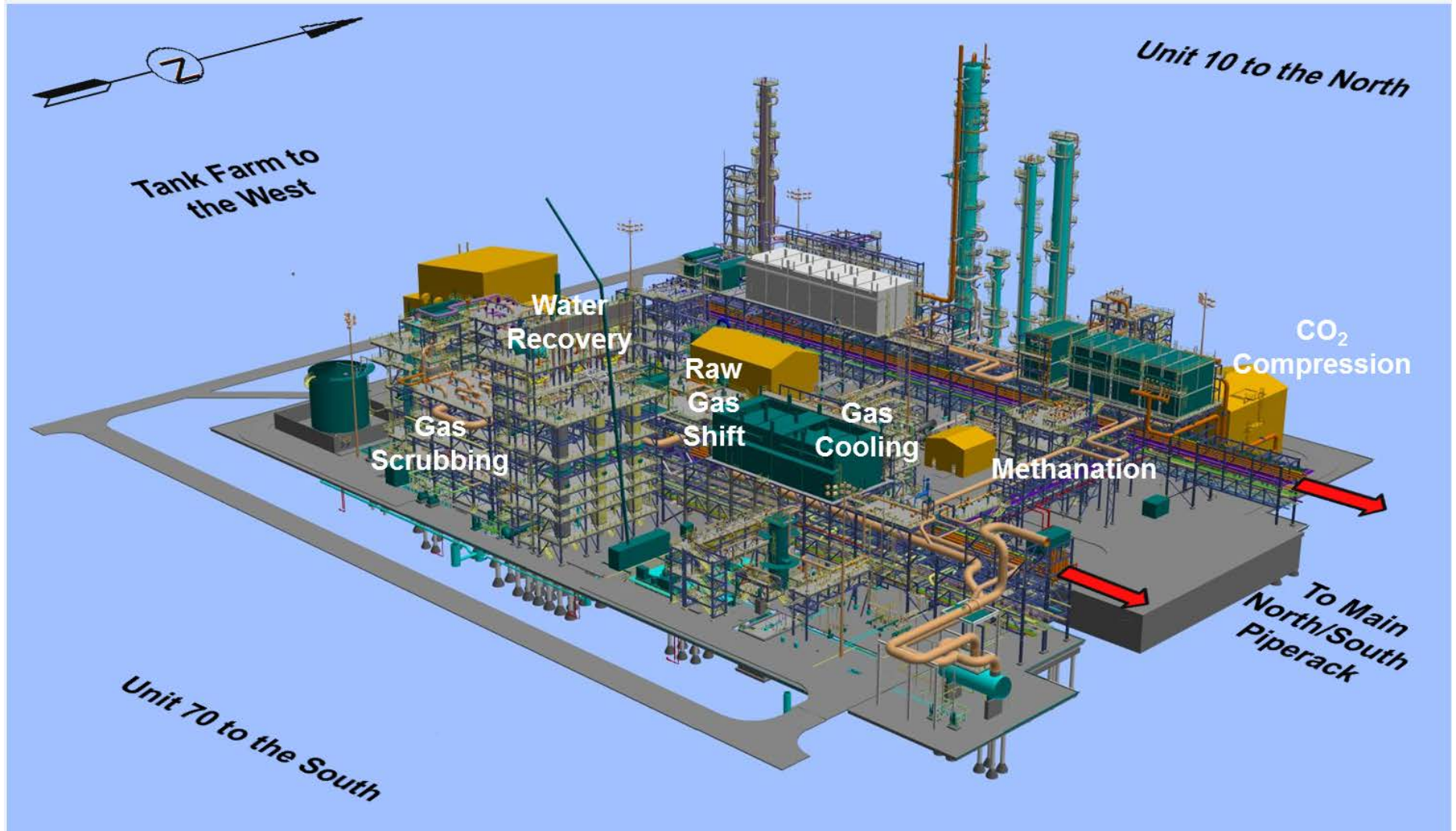

Figure 1.9.5 – Rectisol® and CO₂ Booster Compression Units – 3D Front View of General Piping Layout

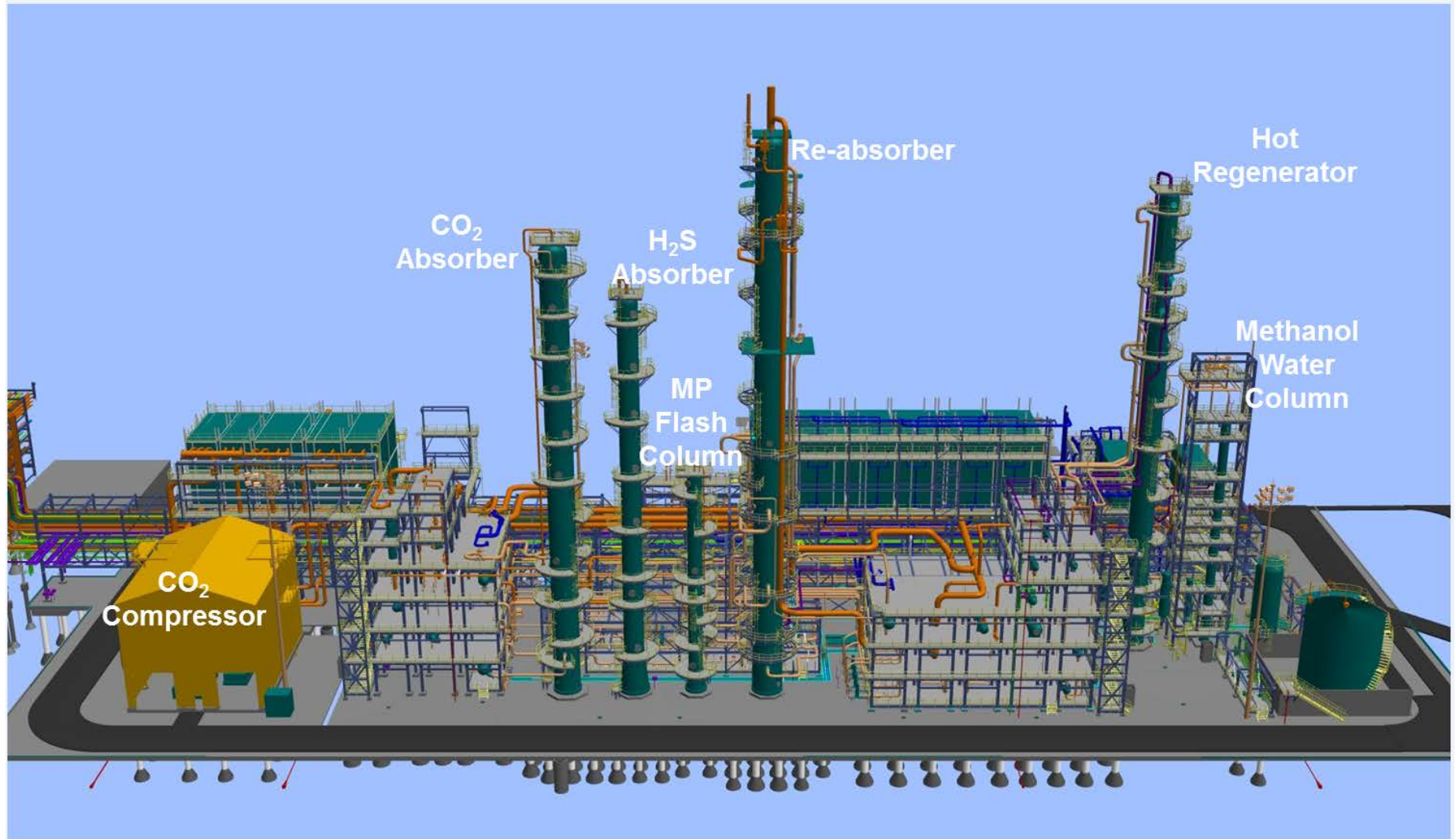
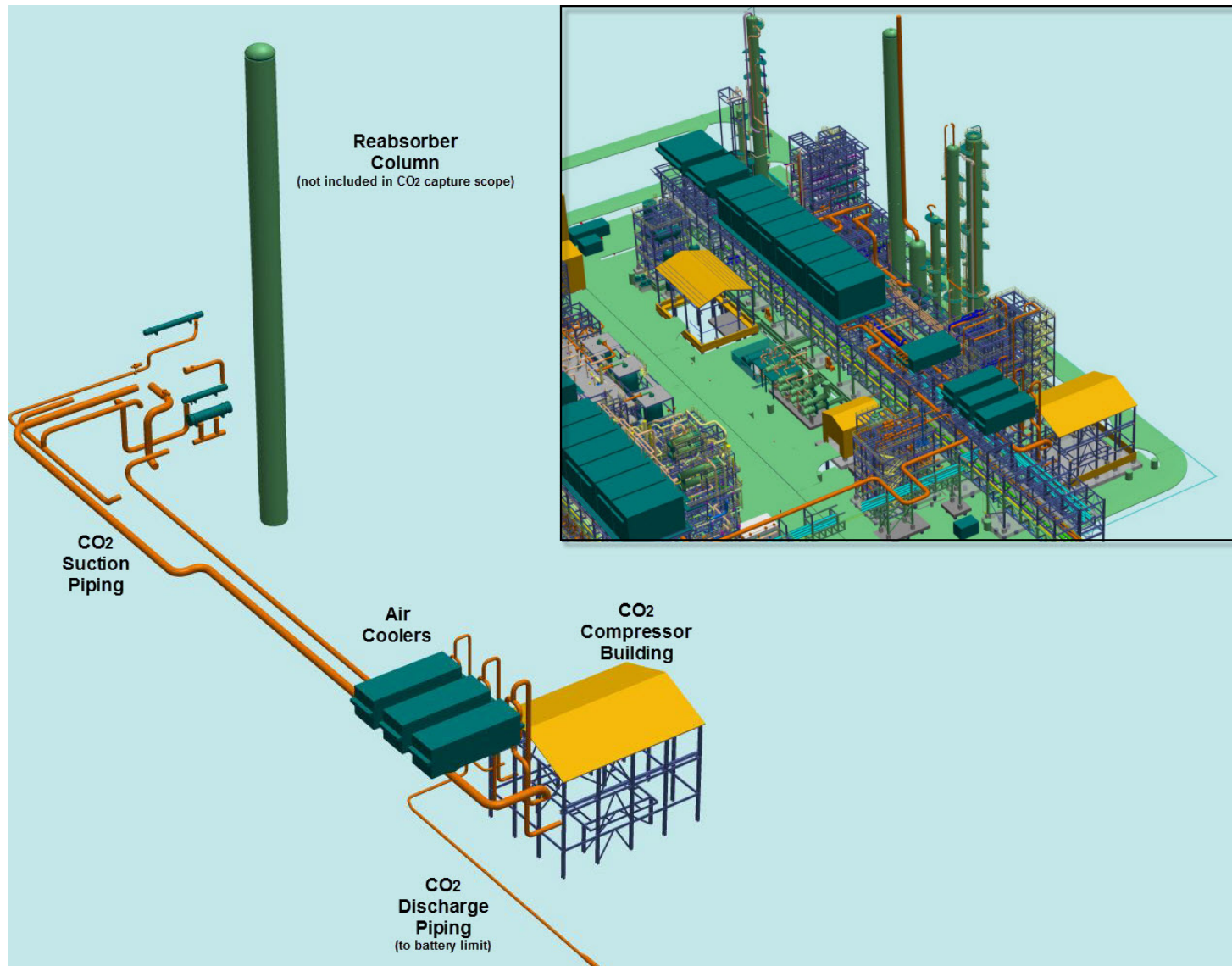

Figure 1.9.6 –3D NW View of CO₂ Piping Layout



SECTION 1 CAPTURE		
Section 1.10 CO₂ Dehydration technology - approach		
Description:	Keeping the level of water at a minimum level prior to entering the pipeline is essential for corrosion control. Documentation of the process steps to achieve specification CO ₂ would be valuable.	
Purpose:	Sharing of best available technologies and knowledge on this issue is valuable for future CCS projects, in order to choose cost efficient and dependable solutions.	
Reporting Requirements:	Quantitative Data/Information	Qualitative Knowledge
Before Operation	Describe the drying technology. Total level of drying required (ppm water). Level of drying expected for each stage (ppm water).	Rationale for chosen dehydration technology and level of drying required Evaluation of selected technology Lessons learned

Quantitative

An advantage of the Rectisol[®] process is that it produces extremely dry CO₂ off gas with water content less than 1 ppm wt., within the design specifications of the pipeline and storage facilities or for use in enhanced oil recovery operations. Since no dehydration is required at the NWR site, the description below is focused on the dehydration process at the Agrium plant.

Description of the drying technology (including levels of drying – per stage and total)

The Agrium CO₂ stream is saturated, with water at 401,224 PPMW, and requires various processing steps to achieve dense phase pressure for entry into the pipeline. Moisture removal is facilitated at each of the process stages.

- The first step of moisture removal takes place in the inlet area where the CO₂ stream passes through plate and frame heat exchangers, contacted with chilled glycol. Approximately 95.6% of the moisture is removed at this phase, under typical operating scenarios. In colder operating conditions, condensing will also take place in the overhead CO₂ carrier pipe and is collected.
- The second step of moisture removal takes place during compression of the CO₂ stream. In the suction scrubber and the inter-stage suction scrubbers, an additional 4.2% moisture is removed, bringing down the moisture level to 1,287 PPMW.
- The last step of moisture removal takes place in the glycol dehydrator. Absorption of water vapor in Triethylene glycol (TEG) is a very common method of moisture removal from process gas. The natural gas industry has been using this technology for decades,

and a lot has been learned about process design, materials selection and operating characteristics. The wet CO₂ gas is brought into contact with dry glycol in an absorber. Water vapour is then absorbed in the glycol and consequently its dew point is reduced. The wet rich glycol then flows from the absorber to a regeneration system in which the entrained gas is separated and fractionated in a column and reboiler. The heating allows boiling off the absorbed water vapour and the water dry lean glycol is cooled (via heat exchange) and pumped back to the absorber. About 0.20% of the remaining water is removed in this process, thereby achieving a moisture level less than 208 PPMW prior to entering the pipeline.

A reliable moisture metering system is an integral part of the dehydration system. It will be configured to ensure that the process flow meets the high level set point of 84 PPMW or less at all times (quality set points). If a high moisture content is detected, the system flow is diverted to a vent until the upset condition is stabilized or the process issue is rectified thereby ensuring no wet CO₂ ever enters the pipeline.

The final target level of drying required is a maximum of 10 pounds per million standard cubic (lbs/MMSCF) or 0.16 kg/ 10³ m³ in order to ensure no material water in the system.

Qualitative

Rationale for chosen dehydration technology and level of drying required

Enhance will employ the Triethylene glycol (“TEG”) method, as this technique is commonly used in industry – notably in the processing of natural gas and natural gas liquids. Most natural gas producers use TEG to remove water from the natural gas stream in order to meet the pipeline quality standards. This process is required to prevent hydrate formation at low temperatures, as well as corrosion problems due to the presence of water along with carbon dioxide or hydrogen sulfide (regularly found in natural gas).

This dehydration technology is well established, and has been proven effective in many installations. This technology has widespread use in CO₂ EOR in the United States and has been used for over 40 years dehydrating CO₂ for use in EOR. Water vapour is removed from the gas by reducing the inlet water dew point (temperature at which vapour begins to condense into a liquid) to the outlet dew point temperature, which will contain a minimum amount of water. The technology is transferable and effective in pure CO₂ streams as well, and thus applicable to ACTL since the CO₂ is being transported in its dense phase in the pipeline. Based on its widespread success, Enhance will be using the dehydration technology for its project.

SECTION 1 CAPTURE		
Section 1.11 Scale-up experience and methodology – approach		
Description:	One of the largest technological risks of building a commercial scale CO ₂ capture system relates to the lack of experience with design and operation of CCS-scale plants. These risks are normally handled by a combination of pilot-scale testing and modelling. It would be valuable to share the scale-up philosophy applied and the experience gained during process development, such as modelling tools used for verification of piloting, reference plants, lab-tests, mock-up studies, use of scale-up correlations, use of rules of thumb for scale-up, dimension analysis, principles of similarities.	
Purpose:	Sharing information regarding scale-up experience could help reduce project lead time for other CCS projects.	
Reporting Requirements:	Quantitative Data/Information	Qualitative Knowledge
Before start-up	Describe the scale-up methodology used for arriving at the full scale plant design, including references to all relevant test activities used to gain confidence in the functionality of the technology. Identify the current largest scale use of chosen technology.	

Quantitative

Commercial Scale-up

More than 50 Lurgi Rectisol[®] plants are in successful operation around the world. Since 2000, Lurgi has licensed 34 Rectisol[®] units for different applications and sizes. As a mature acid gas separation and conditioning technology that has been in commercial operation around the world since the 1950s, the scale up methodology for Rectisol[®] is not relevant for carbon capture.

The largest scale Rectisol[®] applications in the world to date are two coal – methanol to propylene (MTP) plants that achieved commercial operation in 2011. They were developed by the Shenhua Ningxia Coal Industry Group Co., Ltd. in Yinchuan, Ningxia Hui Autonomous Region, China, and by the Datang International Power Generation Co. Ltd. in Erdos, Inner Mongolia Autonomous Region, China. Each plant has a nameplate capacity of 18,130,000 Nm³/day, over three times the capacity of the NWR Rectisol[®] unit.

In 2012, Shenhua Ningxia Coal Industry Group Co., Ltd. awarded a contract for the purification of syngas for a Coal to Liquid (CTL) plant to Lurgi. With a processing design capacity of more than 105,000,000 Nm³/day in four trains, when built, this plant will be the world’s largest Rectisol[®] installation.

Refer to Table 1.11.1 for an overview of recent Rectisol[®] units designed and licensed by Lurgi. A complete list of Lurgi Rectisol[®] applications is provided in the attached Reference List.

Table 1.11.1 Lurgi Rectisol® Applications from 2000 to 2010

Application	Number of Projects	Country
Coal to fertilizer plants	11	China
Coal to methanol plants	9	China
Coal to DME via methanol	1	China
Coal to Propylene via methanol	2	China
Refinery residue to hydrogen and/or power	3	China, Canada, Germany
Coal to steel reduction gas	1	India
Petroleum coke to hydrogen and methanol	2	China, USA
Petroleum coke to SNG	1	USA
Coal to liquid (FT-Synthesis)	4	China

Lurgi Gasification – A World Wide Success Story

- Differentiated by the ability to remove acid gas and trace contaminants, the Lurgi Rectisol® gas purification process has a dominant market share around the world.
- According to the Gasification Technologies Council, 75 % of the syngas produced from coal, heavy oil and wastes are purified in Rectisol® units.
- Rectisol® units produce 90% of the syngas produced for chemical synthesis (e.g., without gasification) such as for the production of ammonia and methanol.
- Lurgi delivers lump sum turnkey projects including the complete syngas and synthesis train, as well as licensing and basic engineering packages.

History of Rectisol® Technology

- Rectisol® was invented by Lurgi/Linde more than half a century ago, in 1949.
- The first Rectisol® installation was started up in Sasolburg, in the Republic of South Africa, in 1955 from coal gasification to produce synthetic oil. In the following decades, Rectisol® paved the way for world scale ammonia and Fischer-Tropsch synthesis.
- In the 1970’s and 1980’s, oil residue gasification proved to be another field of application. Rectisol® remains unique in reaching synthesis gas quality in one single process and is the only coal and oil residue gasification process capable of removing all raw gas contaminants.
- A worldwide surge in coal based gasification installations since 2000 has significantly increased the number and track record of Rectisol® plants in operation. Nearly all of the coal gasification units for production of ammonia, methanol, hydrogen or syngas is or will be equipped with a Rectisol® gas purification system.
- The purification of syngas produced by gasification of heavy oil residue from recovery of oil sands or shale oil is a new field of application.

Reference List

Rectisol[®] - Lurgi Technology

Reference List

Rectisol® - Lurgi Technology

Award date	Plant name	Country	Capacity [Nm ³ /d]	No. of units	Feedgas	Main Product
2013	Yitai Ganqanbao CTL	China	48.000.000	2	ECUST Coal POX	Fischer-Tropsch Synthesis Gas
2012	CNOOC Huizhou Refinery & Petrochemicals Project	China	10.705.400	1	E-Gas Coal + Petcoke POX (COP)	Hydrogen, Oxogas
2012	Shanxi Lu'an Group CTL	China	27.023.000	2	Shell Coal POX	Fischer-Tropsch Synthesis Gas
2012	Shenhua Xinjiang CTO Project	China	19.500.000	2	GE Coal POX (Texaco)	Methanol
2012	Sino-Kuwait Guangdong / Sinopec Zhanjiang Petrochemical	China	9.818.000	1	GE Coal + Petcoke POX (Texaco)	Hydrogen
2012	Shenhua SNCG CTL - Rectisol	China	105.600.000	4	Siemens Coal POX (formerly GSP)	Fischer-Tropsch Synthesis Gas, Methanol
2012	China Power Investment Yinan	China	39.144.000	2	Siemens Coal POX (formerly GSP)	SNG Syngas
2012	Yitai Yili CTL Rectisol	China	25.432.000	2	ECUST Coal POX	Fischer-Tropsch Synthesis Gas
2011	Sinopec Nanjing Nanhua	China	5.636.000	1	GE Coal POX (Texaco)	Hydrogen, NH ₃
2011	Qinghai Salt Lake DMTO	China	9.426.000	1	ECUST Coal POX	Methanol
2011	Yanchang Petroleum Yanan	China	6.071.000	1	GE Coal POX (Texaco)	Methanol
2011	Ningxia Baofeng	China	12.329.000	1	GSP Coal POX	Methanol
2011	Sinopec Maoming Petrochemical	China	9.181.000	1	GE Coal + Petcoke POX (Texaco)	Hydrogen
2011	AL TGI/SCJ	China	5.184.000	1	GE Coal POX (Texaco)	NH ₃
2010	Luoyang MEG	China	2.400.000	1	WHG POX	Mono Ethylene Glycol
2010	Henan Yongchen Longyu Coal Chem. Co.	China	3.874.000	1	WHG POX	NH ₃ , Ethylene Glycol
2008	Zhongyuan Dahua Hebi	China	6.250.000	1	Shell Coal POX	Syngas
2008	Hulunbuir New Gold Co.	China	6.600.000	1	BGL Slagger(Coal POX)	NH ₃ , Urea
2008	Confidential	United States	19.180.000	1	Siemens Coal POX (formerly GSP)	Synthetic Natural Gas (SNG)
2007	Confidential	United States	19.400.000	1	GE, Petcoke, POX	Hydrogen
2006	Shenhua Ningxia Coal Industry Group Co., Ltd. Yinchuan	China	6.515.000	1	Siemens Coal POX (formerly GSP)	Methanol, DME

Reference List

Rectisol® - Lurgi Technology

Award date	Plant name	Country	Capacity [Nm ³ /d]	No. of units	Feedgas	Main Product
2006	Shenhua Ningxia Coal Industry Group Co., Ltd. Yinchuan	China	18.130.000	1	Siemens Coal POX (formerly GSP)	Methanol, MTP
2006	Conoco Phillips Refinery Wilhelmshaven	Germany	9.960.000	1	Shell Oil POX	Hydrogen
2005	Fujian Petrochemical Co., Ltd.	China	7.860.000	1	Shell Oil POX	Hydrogen
2005	Jindal Steel & Power Ltd.	India	7.560.000	1	Lurgi Coal Gasification	Reduction Gas
2005	Datang International Power Generation Co. Ltd. Erdos Inner Mongolia	China	18.130.000	1	Shell Coal POX	Methanol, MTP
2005	Yanzhou Coal Mining C&E Co. Ltd.	China	6.970.000	1	GE Coal POX (Texaco)	Syngas
2005	North West Upgrading Inc. Sturgeon County	Canada	4.920.000	1	Lurgi MPG (Oil POX)	Hydrogen
2004	Zhongyuan Dahua Pujang	China	5.515.000	1	Shell Coal POX	Syngas
2004	Yongcheng C&E Group	China	5.600.000	1	Shell Coal POX	Syngas
2003	Sinopec Hubei	China	4.770.000	1	Shell Coal POX	CO ₂ for Urea Synthesis
2003	Sinopec Anqing	China	5.510.000	1	Shell Coal POX	NH ₃ Synthesis
2003	YanKuang Group	China	5.230.000	1	GE Coal POX (Texaco)	Syngas
2001	Sinopec Baling	China	6.380.000	1	Shifted Gas ex Coal Gasification	NH ₃ Synthesis
1998	EXXON Kawasaki	Japan	8.510.000	1	Texaco Oil POX	IGCC Fuel Gas
1998	DEA Wesseling	China	1.600.000	1	Texaco Oil POX	Methanol Synthesis Gas
1997	Air Products Baytown	United States	3.000.000	1	Texaco Oil POX	Various Synthesis Gases via HyCo Cold Box
1994	CNTIC Henan	China	1.860.000	2	Lurgi Coal Gasification	Town Gas
1994	LG-Chemical Yochon	South Korea	410.000	1	Shell Oil POX	Oxo Synthesis Gas
1994	CNTIC Kaiyuan Shanxi	China	1.500.000	1	Lurgi Coal Gasification	NH ₃ Synthesis
1993	Sinopec Jiujiang	China	2.100.000	1	Shell Oil POX	NH ₃ Synthesis
1993	Sinopec Lanzhou	China	2.100.000	1	Shell Oil POX	NH ₃ Synthesis
1992	Shell Pernis	Netherlands	4.660.000	1	Shell Oil POX	Hydrogen
1992	CNTIC Hohhot	China	2.100.000	1	Shell Oil POX	NH ₃ Synthesis
1983	SAR Oberhausen	Germany	1.900.000	1	GE Coal POX (Texaco)	Hydrogen, Oxogas
1981	VEB Erdölraffinerie Mider Total Leuna Werke	Germany	7.200.000	2	Shell Oil POX	Syngas
1980	Dakota Gasification Company Beulah	United States	15.600.000	2	Lurgi Coal Gasification	Reduction Gas
1979	Sasol Transvaal	South Africa	39.600.000	4	Lurgi Coal Gasification	Fischer-Tropsch Synthesis Gas

Reference List

Rectisol® - Lurgi Technology

Award date	Plant name	Country	Capacity [Nm ³ /d]	No. of units	Feedgas	Main Product
1979	Union Kraftstoff Wesseling	Germany	1.000.000	1	Shell Oil POX	Methanol Synthesis Gas
1979	Quimical Lavradio	Portugal	2.400.000	1	Shell Oil POX	NH ₃ Synthesis
1978	CNTIC Tai-Yuan	China	2.880.000	1	Lurgi Coal Gasification	NH ₃ Synthesis
1978	Petrobas Curitiba	Brazil	2.700.000	1	Shell Oil POX	NH ₃ Synthesis
1977	Sasol Transvaal	South Africa	39.600.000	4	Lurgi Coal Gasification	Fischer-Tropsch Synthesis Gas
1977	Fertilizer Comp. of India Haldia	India	1.800.000	1	Shell Oil POX	NH ₃ Synthesis
1976	Fertilizer Comp. of India Ramagundam	India	2.400.000	1	Koopers Coal Gasification	NH ₃ Synthesis
1976	Fertilizer Comp. of India Panipat	India	2.100.000	1	Shell Oil POX	NH ₃ Synthesis
1976	Werke (Mider)	Germany	7.200.000	1	Shell Oil POX	NH ₃ Synthesis
1976	BP VEBA Chemie AG Gelsenkirchen	Germany	3.800.000	1	Shell Oil POX	NH ₃ Synthesis
1976	Fertilizer Comp. of India Talcher	India	2.400.000	1	Koopers Coal Gasification	NH ₃ Synthesis
1976	Fertilizer Comp. of India Bhatinda	India	2.100.000	1	Shell Oil POX	NH ₃ Synthesis
1976	Fertilizer Comp. of India Sindri	India	2.100.000	1	Shell Oil POX	NH ₃ Synthesis
1975	Fertilizer Comp. of India Nangal	India	2.100.000	1	Shell Oil POX	NH ₃ Synthesis
1975	Sasol Transvaal	South Africa	5.300.000	1	Lurgi Coal Gasification	Fischer-Tropsch Synthesis Gas
1975	Union Kraftstoff Wesseling	Germany	1.700.000	1	Shell Oil POX	Methanol Synthesis Gas
1975	Hydro Agrar (VEBA)	Germany	4.500.000	4	Vacuum Residue	Syngas NH ₃
1973	National Fertilizer Ltd.	India	2.100.000	3	Bunker-C-Oil	Syngas NH ₃
1971	ANG Beuhla	United States	14.900.000	2	Lurgi Coal Gasification	Synthetic Natural Gas (SNG)
1971	British Gas Westfield	UK	280.000	1	Lurgi Coal Gasification	Synthetic Natural Gas (SNG)
1971	BP VEBA Chemie AG Gelsenkirchen	Germany	4.000.000	1	Shell Oil POX	Syngas
1969	VEBA-Ruhröl	Germany	4.300.000	4	Vacuum Residue	Syngas NH ₃ +MeOH
1968	Chemopetrol Litinov	Czech Republic	3.600.000	6	Heavy Fuel Oil	Syngas NH ₃
1967	Union Kraftstoff Wesseling	Germany	1.300.000	1	Shell Oil POX	Methanol Synthesis Gas
1967	Strojimport Vresova	Czech Republic	5.800.000	2	Lurgi Coal Gasification	Town Gas
1967	Invest-Import Velenje	Slovenia	2.500.000	2	Lurgi Coal Gasification	NH ₃ Synthesis
1966	Brooklyn Union Gas	United States	320.000	1	Natural Gas	Natural Gas Peak Shaving
1965	Strojimport Most	Czech Republic	2.400.000	2	Lurgi Coal Gasification	Town Gas
1965	Invest-Import Kosovo	Serbia	2.200.000	1	Lurgi Coal Gasification	NH ₃ Synthesis
1964	Sasol Transvaal	South Africa	2.800.000	1	Lurgi Coal Gasification	Town Gas

Reference List

Rectisol® - Lurgi Technology

Award date	Plant name	Country	Capacity [Nm ³ /d]	No. of units	Feedgas	Main Product
1964	Borden Chemical Comp. Geismar	United States	450.000	1	Raw Gas	Syngas
1964	Rohm and Haas Comp. Deerpark	United States	340.000	1		Hydrogen

Built up to 1964 29 units with a capacity of 6.000.000 Nm³/d from Coal and Oil Gasification in Czech Republic, Germany, South Africa and Russia for town gas, NH₃ and Fischer-Tropsch synthesis.

SECTION 2 TRANSPORTATION		
Section 2.1 General description of CO₂ pipeline system phases		
Description:	Describe the pipeline system; including the ERCB Baseline map (or equivalent) and description of the leak detection system. Identify who the owner of the pipeline system is and who is liable for operation and maintenance of the pipeline system.	
Purpose:	This information is relevant for industry and R&D to build competence in pipeline transportation of CO ₂ . Some of this information is also relevant for building public awareness on pipeline transport of CO ₂ .	
Reporting Requirements:	Quantitative Data/Information	Qualitative Knowledge
During Concept and Design phase	Provide a description of the pipeline design, including but not limited to the following: <ul style="list-style-type: none"> - the phase in which CO₂ is transported - line pipe specification - pipeline valve seals (type, e.g., elastomers) - block valves (number and location/spacing) - other types of valves (number and location/spacing) - vent stations (number and location/spacing) - pigging stations (number and location/spacing) - external coating (and internal coating if any) of the pipeline - cathodic protection system (impressed current cathodic protection, sacrificial anode or others) - pipeline routing, shown with the ERCB Baseline map (or equivalent) - pipeline burial and depth of cover - schematic of battery limits (capture and storage) - description of leak detection system - risk analysis, as per ERCB application - maximum operating pressure - Any special considerations for crossings - pipeline integrity management system Measurement schematic, showing reference points for data collection analysis and interpretation purposes	

ERCB base map – see Appendix vii

Pipeline design, including but not limited to the following:

The phase in which CO₂ is transported

The CO₂ is transported in its dense state above the supercritical point.

Line pipe specification

The line pipe is a Nominal Pipe Size (NPS) 16 inch diameter, Grade 448 at 14.3 mm wall thickness.

Pipeline valve seals (type, e.g., elastomers)

The pipeline valve seals are made of a Teflon Product (type PTFE), this type of seal is not an elastomer. The fully welded ball valves are double acting, which is they have both upstream and downstream sealing.

Block valves (number and location/spacing)

There are 15 block valves assemblies at a nominal 15 kilometers spacing along the pipeline (see [Appendix viii](#) for schematic).

Other types of valves (number and location/spacing)

There are no additional valves required for the pipeline.

Vent stations (number and location/spacing)

Each mainline block valve assembly has two cross-over and/or blow down valves included.

Pigging stations (number and location/spacing)

There is a provision for one launcher at the North End (Ft. Saskatchewan) and one receiver at the South End (Clive). The launchers will be portable units, as pigging will only be required for initial baseline (smart pigging) and approximately every 5 years after initial operation.

External coating (and internal coating if any) of the pipeline:

The pipeline external coating will be with any one of several industry-accepted standard coatings. The most likely coatings to be used will include either fusion bond epoxy extruded polyethylene or an extruded epoxy coating system. Both of these coating would be applied in accordance with the requirements of CSA Z245.21 – External Polyethylene Coating for Steel Pipe. The decision as to which coating will be determined through the detailed design process. Internal coatings will not be applied to the pipe. The pipelines are designed for internal smart pigging, as part of the pipeline integrity management system. No special considerations are required for CO₂ transportation design.

Bored or Horizontal Directional Drill (“HDD”) crossings will have an additional external abrasion resistant coating with multi-layer pipe sleeves used on the joints when required to prevent damaging the coating when pulling the pipe through the drilled hole. All pipe bends that are fabricated using an induction method will be coated with an epoxy type coating following the bending process. All joints shall be field coated according to the coating manufacturer’s recommendations as well as Enhance specifications.

Cathodic protection system (impressed current cathodic protection, sacrificial anode or others)

A cathodic protection system will be installed as part of the corrosion reduction program. The design of this system will be undertaken as a part of the detailed design for the project. The system will incorporate the following criteria:

- Length of system and segments

- Coating specifications
- Locations of block valves
- Soil analysis and resistivity data
- Water table
- Proximity to other utilities

A DC potential will be imposed on the pipeline where required, in order to maintain a minimum negative potential between the steel pipe and the soil. The system will consist of a rectifier coupled to either horizontally or vertically-installed ground beds. Vertical deep well ground beds can be drilled to an appropriate depth, thereby reducing the amount of ground disturbance required. The size of the rectifier and number of anodes required will depend on the cathodic current requirements and types of soil encountered. Impressed current supply and anode beds will be designed for the pipeline to ensure that protection is effective.

The pipeline will require cathodic protection test stations to be installed along the route of the pipeline at regular intervals. The pipeline will be fitted with insulating flanged gaskets at each end of the system.

The carbon dioxide water dew-point specification is less than 162mg/m³ (10 lbs/mm³scf); therefore, free water is not present during normal operating conditions, and corrosion due to the formation of Carbonic acid cannot occur. Post hydrostatic testing procedures are to be incorporated to ensure the pipeline is dry prior to commissioning and operation. In the event the water dew-point is exceeded at the source, an on line hydrometer signals an ESDV to close diverting the off spec gas to vent.

Pipeline routing, shown with the ERCB Baseline map : attached in *Appendix vii*

Pipeline burial and depth of cover

The minimum depth is 1.2 metres. At all crossings (road, railroad, other pipelines and at water and environmentally sensitive areas the depth of cover can be considerably deeper. The depth of cover under the left bank of the North Saskatchewan River will be 60 metres. Under the bed of the Battle River the earth cover will be 20 metres. Since the minimum depth of cover in the ditch of a road will be 1.4 metres, the bury depth under the road can be considerably deeper depending on the road grade height. There is a combination crossing of both a road (HWY 21) and a railway (CNR) between NE ¼ 29-048-21 W4 and SW ¼ 33-048-21 W4 where the depth of cover will be 30 m. There are numerous foreign pipeline crossings where the depth of cover will be considerably deeper because in addition to going under all foreign pipes there is also a minimum separation of 1/3 of a metre (300mm) required.

Schematic of battery limits (capture and storage):

The schematic of the battery limit is shown in the diagram on the following page.

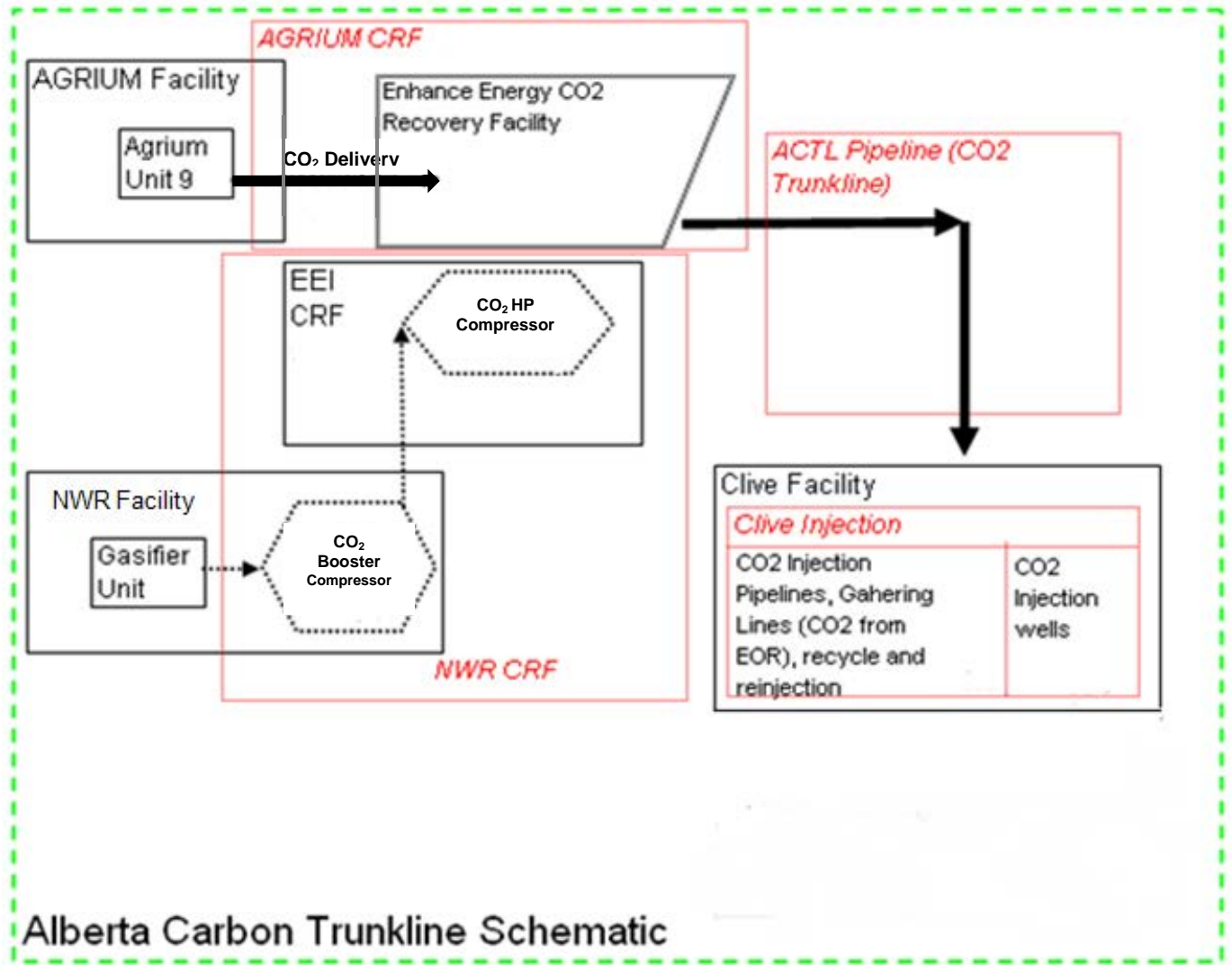

Description of leak detection system:

Leak detection requirements, as specified in the *Alberta Pipeline Act* and Regulations, will be implemented for the proposed carbon dioxide system, following the “Recommended Practice for Liquid Hydrocarbon Pipeline System Leak Detection” as shown in Annex E of CSA Z662-07. Enhance will incorporate a remote monitoring or SCADA system as part of the pipeline integrity program and if a leak is found, the Project-Specific Emergency Response Plan will be implemented. The system will be designed to be a fail-safe system to provide personnel safety, automatic control, equipment shutdown, and alarm annunciation during a malfunction or abnormal operating condition.

The complete comprehensive leak detection system is currently being developed, and will be in place before operations.

Enhance will incorporate a SCADA system as part of the pipeline integrity program which will require development of infrastructure, hiring and training of personnel, as well as the purchase of hardware, software, and the development of an operational system. Leak Detection Systems for High Vapour Pressure (“HVP”) pipelines usually work on two levels:

- First, a material balance is performed by metering the product into and out of the system and doing a line pack calculation based on the pressures seen in the system. If there is a calculated imbalance an alarm is generated.
- The other level of detecting a problem is to monitor the flowing pressure and temperature of each block valve. The monitored pressures and temperatures are compared to the expected temperatures and pressures as calculated by the system. When an anomaly is found, an alarm is generated and all the automated valves along the system are closed. The pressure in each isolated segment of the line is observed to identify if pressure is falling. If a leak is found, the Emergency Response Plan is implemented.

The pipeline system will be monitored and controlled from the Enhance pipeline control center. The system will be designed to be a failsafe system to provide personnel safety, automatic control, equipment shutdown, and alarm annunciation during a malfunction or abnormal operating condition.

Enhance will use a real time transient model type of computational pipeline monitoring system. The system will comply with both API RP1130 and CSA Z662 Annex E. PipelineManager® will be the simulation platform used to access and monitor the data. PipelineManager® is a field-proven pipeline simulation platform that provides the perfect environment to implement advanced pipeline applications related to simulation, systems operations, facility planning, training, and support of the commercial business environment.

Risk analysis, as per ERCB application

Enhance is currently conducting the risk assessment for the project. As this process is still underway, a complete list of risks and corrective and/or preventive measures is not available at this time. The ERCB framework being used to determine these measures is detailed in section 2.6.

Maximum operating pressure

The maximum operating pressure is 17,926 kPag (2,600 psig).

Any special considerations for crossings

All environmentally sensitive areas and water crossings are crossed by the trenchless, horizontal directional drilling (HDD) method.

Pipeline integrity management system

The pipeline integrity management plan is described fully in section 2.6 “Integrity Management Plan.”

Crack arrestors, pump stations and check valves

The pipeline material design is such that crack arrestors are not required.

The initial pipeline supply volumes result in minimal pressure drop and does not require supplementary pump stations to provide additional pressure to offset pipeline hydraulic or pipeline hydrodynamic pressure losses. Check valves are typically located at the discharge end of pumping stations and these are not required for the initial pipeline supply volumes.

Measurement schematic, showing reference points for data collection analysis and interpretation purposes

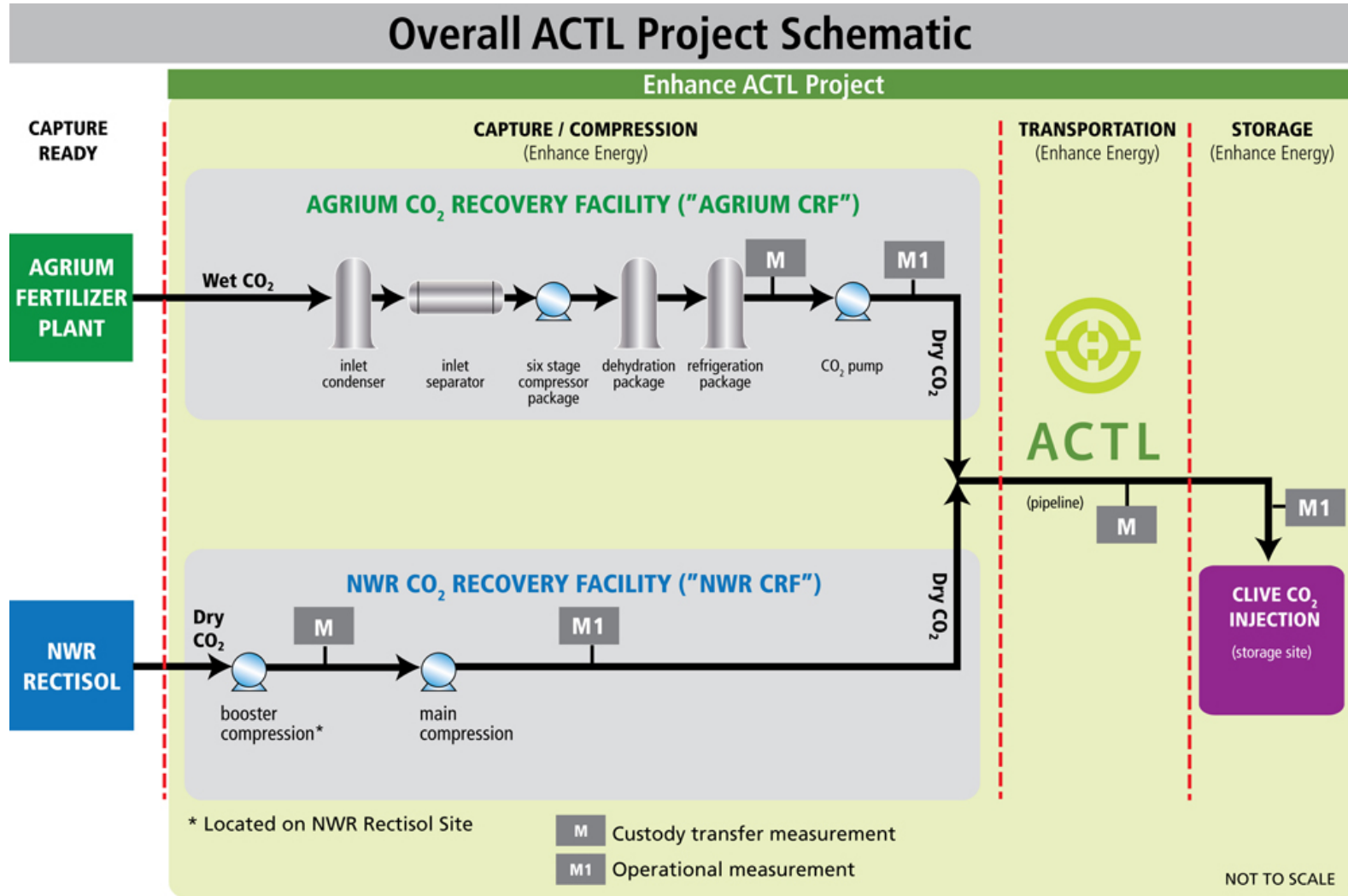

SECTION 2 TRANSPORTATION		
Section 2.2 Capacity		
Description:	Describe the capacity requirements for steady state and/or cyclic (known as transient operation for pipelines) depending on the operation of the plant and the chosen transport solution, and describe the design capacity, actual capacity and ultimate expansion capacity. <ul style="list-style-type: none"> - Start up procedures - Design capacity vs. realized capacity 	
Purpose:	This information is relevant for building competence in industry on pipeline transport of CO ₂ .	
Reporting Requirements:	Quantitative	Qualitative
	Data/Information	Knowledge
During Concept and Design	Reports from FEED and detailed design of the CO ₂ pipeline should include, but not limited, to the following: <ul style="list-style-type: none"> - full capacity of the pipeline - volumetric and mass flow rates expected - operating pressures - operating temperatures - fluid composition (% by volume) 	Design details

Quantitative

Data from FEED and detailed design of the CO₂ pipeline

Full capacity of the pipeline: 14.6 million tonnes a year

Volumetric and mass flow rates expected: 5,200 – 10,500 T/d (100 – 200 mmscfd)

Operating pressures: 7,100 kPag (1,030 psig) – 14,800 kPag (2,147 psig)

Operating temperatures: -18°C to 60°C

Fluid composition (% by volume): as shown in table below

INLET STREAM TABLE				
Component	AGRIUM		NWR	
	kg/hr	mmscfd	kg/hr	mmscfd
	Carbon Dioxide	64,473	29.80	144,281
Carbon Monoxide	0	0.00	73	0.03
Water	0	NA	0	0.00
Hydrogen	230	0.11	682	0.32
Nitrogen	230	0.11	2	0.00
Argon	0	0.00	2	0.00
Methane	115	0.06	87	0.04
Methyl Hydroxide	0	0.00	29	0.01

Qualitative

Design details

The pipeline system is designed to transport CO₂ in dense phase to minimize the energy lost during transportation. Transporting CO₂ in vapour phase results in significant pressure drop per km of line, and results in excessive compression requirements to transport the CO₂.

The maximum designed flowrate for the pipeline system is 40,000 t/d. However, that will require the addition of pumping stations and potentially twinning certain sections of the line depending on the source and sink locations.

The valve stations located every 15 km have been designed so that additional pumping capacity can be installed as CO₂ supplies into the system increase. The initial volume of 4,300 t/d does not require any additional pump capacity to ensure delivery of the CO₂ to Clive at 2,000 psig (17,926 kPag).

The source that feeds into the inlet of the system must be able to deliver the CO₂ at 2600 psig to ensure that as volume is increased, they will be able to feed into the line. The original concept had the sources in the AIH delivering CO₂ at 1,500 psig, but it has been determined that concept is uneconomic due to the additional pumping that would be required to boost to 2,600 psig

The graph below shows the different hydraulic curve modelling for the pipeline, illustrating how the pressure in the pipeline will change along the line. The graph shows three scenarios CO₂ load scenarios, 5,000 t/d, 10,000 t/d and 15,000 t/d.

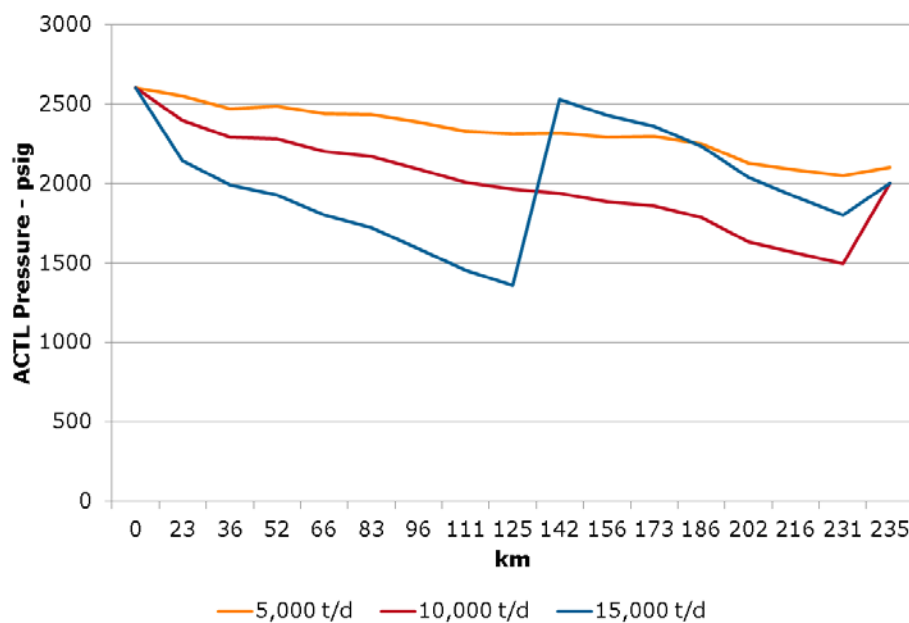

SECTION 2 TRANSPORTATION		
Section 2.3 Characteristics of transported CO₂		
Description:	<p>Characteristics of the transported CO₂ should be stated, since the characteristics may change because of integrated networks. In operational phase these characteristics should be monitored since this may change over time.</p> <p>The Project Plan anticipates an integrated network (<i>e.g.</i>, use as trunk line). The CO₂ composition from the different sources will be measured as part of the contracted inlet requirements. The specifications to enter the pipeline will be set by the trunk pipeline operator.</p>	
Purpose:	<p>This information is relevant for building competence in industry on pipeline transport of CO₂. This information is also relevant for other CCS or EOR projects in Alberta, mainly for planning purposes.</p>	
Reporting Requirements:	Quantitative Data/Information	Qualitative Knowledge
During Concept and Design	<p>Reports from basic and detailed design should include, but not limited, to the following:</p> <ul style="list-style-type: none"> - the required CO₂ specification for the pipeline - expected composition (% by volume or molar %) of the CO₂ stream (<i>e.g.</i>, impurities) of different sources, - expected impurity types and impurity limits allowed in the trunk line (identifying maximum acceptable levels of various impurities), - mass flow rate - temperature - pressure - water content (specified in terms of parts per million on mass bases) 	

The required CO₂ specifications for the pipeline:

- 95 mol percent minimum CO₂
- No more than 2 mol% hydrocarbons with a dewpoint not exceeding -20°F
- No more than 3 lb/mmscf of glycol or amines or ammonia or methanol
- No more than 10 lb/mmscf of water
- No more than 4 ppm H₂S by volume
- No more than 16 ppm total Sulphur by volume
- Less than 1.0% N₂, H₂, CO, AR, or CH₄ each and total inerts less than 4% by volume
- Less than 0.1% O₂
- Less than 100 ppm SO_x or NO_x by volume
- Less than 1 ppb Hg by volume
- No solid particles
- No free liquids including lube oils or glycol

CO₂ shall be delivered at:
Less than 25°C (77°F) and 17,926 kPag (2,600 psig)

Expected composition (% by volume or molar %) of the CO₂ stream (e.g., impurities) of different sources:

NWR CO₂ Stream		
MOLE FRACTION	Units	
H ₂ (hydrogen)	(mol%)	0.295
CO (carbon monoxide)	(mol%)	0.073
CO ₂ (carbon dioxide)	(mol%)	99.507
CH ₄ (methane)	(mol%)	0.098
N ₂ (nitrogen)	(mol%)	0.005
AR (argon)	(mol%)	0.004
CH ₃ OH (methanol)	(mol%)	0.016
H ₂ O (water)	(mol%)	0.000
H ₂ S (hydrogen sulfide)	(mol%)	0.000

Agrium CO₂ Stream (before CRF processing)		
MOLE FRACTION VAPOUR PHASE	Units	
Vap. CO ₂ (carbon dioxide)	%	37.72
Vap. H ₂ (hydrogen)	%	0.29
Vap. N ₂ (nitrogen)	%	0.11
Vap. H ₂ O (water)	%	61.88
Vap. C ₂ H ₆ O ₂ (ethylene glycol)	%	0.00
Vap. NH ₃ (ammonia)	%	0.00
Vapor Total	%	100.00

Expected impurity types and impurity limits allowed in the trunk line (identifying maximum acceptable levels of various impurities)

The general pipeline design parameters are based on a system that will transfer a product that is greater than 95% carbon dioxide, containing trace amounts of H₂S content smaller than 0.004 mol/kmol (<4ppm), and no other impurities.

Mass flow rate

NWR: average 3,500 tonnes of CO₂ per day

Agrium: average 800 tonnes of CO₂ per day

Temperature and Pressure

The Pipeline gathering and transmission system design parameters are noted as follows:

Description	Value
Maximum Operating Pressure on Gathering System	10,340 kPag
Maximum Operating Pressure on Transmission System (MOP)	17,930 kPag
Minimum Delivery Pressure at Sales Point	13,790 kPag
Minimum Design Operating Temperature for Gathering / Transmission Pipeline Systems	-18 °C
Maximum Design Operating Temperature Gathering / Transmission Pipeline Systems	60 °C

Water content

As calculated based on the pipeline specification, water content in the pipeline is 10 lbs/mmscfd.

The pipeline system has a CO₂ specification and minimum CO₂ delivery pressure for all supply volumes. Thus there are neither material fluctuations of composition over time, nor changes in operational process due to several sources. Also, since there are no pump stations in the current design, considerations surrounding changes to the CO₂ as it passes through pump stations is not applicable to the project.

SECTION 2 TRANSPORTATION		
Section 2.4 Emissions from transportation		
Description: Describe fugitives and fuel emissions during transportation. This is required to determine the total system emissions reduction.		
Purpose: This allows sharing of data with industry for benchmarking purposes.		
Reporting Requirements:	Quantitative	Qualitative
	Data/Information	Knowledge
Before Operation	Based on basic/detailed design, estimate the fugitives and fuel emissions during transportation. Estimated CO ₂ emissions (tonnes).	

Since there are no pump stations located along the pipeline, the only material emissions for transportation are fugitive emissions.

Once pipeline design has been finalized, Enhance will provide an estimate of the fugitive emissions of the pipeline system.

SECTION 2 TRANSPORTATION		
Section 2.5 Energy consumption		
Description: Describe the energy used during the transportation. This data is used to align with the requirements of the capture portion.		
Purpose: This allows for the sharing of data within industry for benchmarking purposes.		
Reporting Requirements:	Quantitative	Qualitative
	Data/Information	Knowledge
Before Operation	<p>Based on basic/detailed design the energy used during the transportation should be described. This data is used to align with the requirements of the capture portion.</p> <p>In the case that pump stations are necessary, the energy for these stations should be included.</p> <p>Report total estimated energy consumption.</p>	Benchmarking estimate

Pump stations comprise the only material energy consumption on a pipeline such as the ACTL. Being as there are no pump stations currently planned, there is no material energy consumption to report at this stage.

SECTION 2 TRANSPORTATION		
Section 2.6 Integrity management plan		
Description:	In order to competently manage integrity and safety aspects of the pipeline system, the pipeline will be regularly monitored and inspected. Describe the integrity management plan of the pipeline prior to start-up and during operation	
Purpose:	This information is relevant for building competence in industry on pipeline transport of CO ₂ .	
Reporting Requirements:	Quantitative	Qualitative
	Data/Information	Knowledge
Before Operation	Describe the following programs: <ul style="list-style-type: none"> - integrity management process (risk assessment, inspection, maintenance programs, monitoring, testing, mitigations, interventions, repairs, contingency plans, etc.) - results from in-line-inspection of the CO₂ pipeline - emergency preparedness plans - company policy on pipeline safety and maintenance - operational controls and procedures - safety reporting and communication processes - information management process - corporate and site emergency response plan 	

Integrity management process (risk assessment, inspection, maintenance programs, monitoring, testing, mitigations, interventions, repairs, contingency plans, etc.)

A full-scale integrity management process, including risk assessment, inspection, maintenance programs, monitoring, testing, mitigations, interventions, repairs, and contingency plans, is currently being developed, and will be in place before operational start-up.

Results from in-line-inspection of the CO₂ pipeline

In-line inspections of the CO₂ pipeline will be conducted once the pipeline construction is complete. Results from these tests, will be analyzed and lessons learned from them will be incorporated into the project’s risk mitigation plan before operation.

Emergency preparedness plans:

Enhance will have its final emergency preparedness plan before operations. This plan is based on the framework set out by the ERCB in Directive 071 *Emergency Preparedness and Response Requirements for the Petroleum Industry*. The directive outlines the ERCB regulatory system, and is based on the three following core principles:

- 1) The ERCB regulatory system ensures that appropriate emergency response plans (ERPs) are in place to respond to incidents that present significant hazards to the public and the environment.
- 2) The ERCB regulatory system ensures that there is an effective level of preparedness to implement ERPs.

- 3) The ERCB regulatory system ensures that there is the capability in terms of trained personnel and equipment to carry out an effective emergency response to incidents.

Enhance has designed a framework for its ERP, but it will only be completed immediately before the project is operational so that it remains up to date with the most current personnel and final processes used. The scope of Enhance's ERP is to provide policies, practices and procedures, which will be implemented in whole, or in part, if an emergency situation occurs at the Enhance site. The purpose of the ERP is to:

- Protect the health, safety, and welfare of the public, as well as workers responding to the emergency situation;
- Minimize potential adverse effects to the environment;
- Assist personnel in determining the appropriate responses to emergency situations;
- Provide personnel with established procedure and guideline to:
 - Notify and communicate with the appropriate Enhance emergency response team members and government agencies, as well as additional emergency support services;
 - Respond to the emergency situation;
 - Safely evacuate residents to pre-arranged hotels or shelters;
 - Manage media/public enquiries;
 - Notify the next of kin, if applicable;
 - Minimize the effects that disruptive events can have on company operations by reducing recovery times and costs; and
 - Be utilized as a training tool for emergency response exercises and tabletop drills.

Company policy on pipeline safety and maintenance

Enhance is in the process of developing the required operating and maintenance manual.

The pipeline will be designed, built and operated in accordance with the CSA Z662-11 Code. While the requirements outlined by the abovementioned code will be in place before operations, they are currently still being developed.

The safety and loss management system will include the following elements:

- (a) clearly articulated policy and leadership commitment;
- (b) an organizational structure with well-defined responsibilities and authorities that support the effective implementation of the safety and loss management system;
- (c) a process for the management of resources, including:
 - i. the establishment of competency requirements;
 - ii. an effective training program; and
 - iii. contractor selection and performance monitoring;
- (d) a communication plan that supports the effective implementation and operation of the safety and loss management system;
- (e) a document and records management process for the effective operation of the safety and loss management system;

- (f) operational controls, including the development of procedures for hazard identification and risk management, design and material selection, construction, operations and maintenance, pipeline system integrity management, and security management;
- (g) a management of change process; and
- (h) a continual improvement process, including
 - a. performance monitoring for the ongoing assessment of conformance with the requirements of the safety and loss management system, and the mechanism for taking corrective and preventive measures in the event of nonconformance;
 - b. development of measurable objectives and targets; and
 - c. periodic audits and reviews to evaluate the effectiveness of the safety and loss management system in achieving objectives and targets.

Operational controls and procedures

Supervisory Control and Data Acquisition (“SCADA”) will be by a Cellular Phone Trunkline Backbone System. The system acquires data at all mainline block valves and from both end points of the pipeline system. The data and information gathered includes temperature, pressure and volume conditions of the CO₂ product contained within the pipeline conduit. In addition to these pressure, temperature, and volume datum, all ambient conditions as well as ground temperatures are monitored, acquired and reported. This product and ambient information is transmitted in real time via the select cellular phone network. This information is used to supervise and control the pipeline system.

Safety reporting and communication processes

The preliminary safety reporting and communication process is as per the Enhance Energy Corporate Health & Safety Manual.

Information management process: The information management process will be finalized within the required pipeline operating and maintenance manual.

Corporate and site emergency response plan

Enhance is currently working with an ERP consulting company, in order to upgrade and update its Corporate Emergency Response Plan to include this Project, and is preparing an ERP that is specific to this Project. This ERP will be in place before start-up, as required by the ERCB.

SECTION 3 STORAGE		
Section 3.1 Screening criteria		
Description:	List the specific criteria used for evaluating potential Storage Sites.	
Purpose:	This knowledge allows for industry and R&D capacity-building within methodologies for screening of storage sites. This is important information in developing methodologies for screening potential storage sites.	
Reporting Requirements:	Quantitative Data/Information	Qualitative Knowledge
Before Operation	Type of geological formation. Capacity (see Section 3.2). Injectivity. Pressure and temperature. Containment, including possibility of multiple barriers. Conflict with other subsurface users. Impact of population density to site selection as determined by company. Knowledge of well locations including old, abandoned wells. Ability to be monitored. Data access (well log information, geological description, subsurface structure, geological and flow models, 2D and/or 3D seismic).	
	Data capture frequency	Annually and updated as necessary

Type of geological formation

The Plains CO₂ Reduction (PCOR) Partnership’s report, *Factors Affecting the Potential for CO₂ Leakage from Geological Sinks*, states that: “potential sites for geologic CO₂ sequestration are depleted petroleum reservoirs, deep saline aquifers, deep unminable coal seams, and mined salt caverns” (page 3). However, since EOR is an integral component of Enhance’s project, the only storage sites considered were depleted petroleum reservoirs.

In their 2002 article in the Journal of Canadian Petroleum Technology, *Screening, evaluating, and Ranking of Oil Reservoirs Suitable for CO₂-Flood EOR and Carbon Dioxide Sequestration*, Jerry Shaw and Stefan Bachu describe acceptable ranges for fields that would be well suited for CO₂-flood EOR. Enhance followed these evaluation criterion (describe in the table below) when screening its potential storage sites.

Screening Criteria	Acceptable Ranges
Reservoir Temperature	31°C – 121°C
Reservoir Pressure	>10.3 MPa
Pressure/Minimal Miscibility Pressure	>0.95
Oil Gravity	27°API - 48°API
Fraction of Remaining Oil Before CO₂ Flooding	S ₀ > 0.25
Reservoir Permeability	> 5 x 10 ⁻¹⁵ m ²
Injectivity	4 – 20 million mcf/injector

Containment and ability to be monitored

As depleted hydrocarbon reservoirs have securely contained fluids for millions of years, these reservoirs are very well suited for containment and safe storage of injected CO₂. The nature of EOR operations utilizing CO₂ is of voidage replacement, i.e. produced oil and gas is replaced on a one to one basis with the injected CO₂. Hence such operations never exceed the original reservoir pressure and temperature regimes. As well, depleted hydrocarbon reservoirs have typically undergone waterflood operations whereby water has been used to replace produced hydrocarbons. The injectivity of CO₂ is typically estimated to be the same as injectivity of water at reservoir conditions.

Conflict with other subsurface users

Under CO₂ EOR operations, the operator of the CO₂ injection scheme also holds the mineral leases for the same horizon, as such there are typically no conflicts with other subsurface users.

Impact of population density to site selection

Population density is also a consideration for site selection, while it does not impact containment of CO₂ it does play a significant role in the ability to conduct field operations and in the public's perception of safety.

Knowledge of well location and data access

The Energy Resources Conservation Board (ERCB) database can be used to determine location and status of all wellbores including complete well history, i.e. drilling, completion, production and ultimate abandonment, well tests, well logs, subsurface fluid and soil samples and cores. Such data may be used to provide an assessment of the subsurface mapping of aquifers and aquitards, seals and barriers and potential pathways for leaks.

SECTION 3 STORAGE		
Section 3.2 Methodology for calculating capacity		
Description: Describe the methodology for estimating storage capacity.		
Purpose: This knowledge allows for industry and R&D capacity-building within methodology for screening of storage sites. This is important information in developing methodologies for screening potential storage sites.		
Reporting Requirements:	Quantitative	Qualitative
	Data/Information	Knowledge
Before Operation	Capacity calculated. Output from reservoir simulation software and discussion of assumptions. Sensitivity to different injectivities, injection strategies, well type (vertical/horizontal) in a multi-well system. Pressure management strategy.	
	Data capture frequency	

Capacity Calculated

(Including output from from reservoir simulation software and discussion of assumptions)

In determining the capacity of its storage fields, Enhance, once again, looked to established scientific research in determining its methodology. Specifically, Enhance focused on at Stefan Bachu’s report entitled *Evaluation of CO₂ Sequestration Capacity in Oil and Gas Reservoirs in the Western Canada Sedimentary Basin*. Here, Bachu provides valuable definitions for CO₂ sequestration capacity. The one most useful to Enhance’s project is that of theoretical capacity. Bachu defines this concept as a capacity calculating that: “assumes that all the pore space (volume) freed up by the production of all recoverable reserves will be replaced by CO₂ at in situ conditions” (page 13).

Enhance used Bachu’s formula for calculating theoretical capacity. This theoretical capacity formula is:

$$M_{CO_2} = \rho_{CO_2res} \cdot [R_f \cdot A \cdot h \cdot \phi \cdot (1 - S_w) - V_{iw} + V_{pw}]$$

Where,

M_{CO₂} : capacity (CO₂)

ρ_{co2res}: density of the CO₂ in the reservoir

A: area

h: thickness

φ: porosity

(1- S_w): oil saturation

V_{iw}: volume of injected water

V_{pw}: volume of produced water

The terms to the right of the CO₂ density is the volumetric size of the reservoir. As Clive consists of two reservoirs, the Nisku and the Leduc, this calculation is aggregated to represent both reservoirs.

The volumetric oil capacity of the Nisku is 69 million barrels (mmbbls) and the Leduc is 97 mmbbls, for total original oil in place volumes of 166 mmbbls.

Reservoir simulation results suggest an ultimate oil recovery factor of 60%. This volume is replaced by CO₂. This is approximately 100 mmbbls (15.9 10⁶ m³) of oil recovered.

1 m³ of recovered oil occupies a subsurface volume of 1.45 m³ due to liberation of solution gas during production operations.

The temperature and pressure of the Clive reservoir is 69°C (156°F) and 1,813 psig (12,500kPag). At these conditions the density of CO₂ is 382 kg/m³.

Incorporating the above factors, the replacement of produced oil in the Clive reservoir with CO₂ provides storage capacity of:

$$15.9 \cdot 10^6 \text{ m}^3 \cdot (1.45) \cdot (382 \text{ kg/m}^3) / (\text{tonne}/1000\text{kg}) = 8.9 \text{ MT CO}_2$$

The volumetric gas capacity of the Nisku is 36 Bcf and the Leduc is 19 Bcf, for a total original gas in place of 55 Bcf.

Reservoir simulation results suggest an ultimate gas recovery factor of 80%. This volume is also replaced by CO₂. This is approximately 44 Bcf (1,250 10⁶ m³) of gas recovered.

1 m³ of recovered gas occupies a subsurface volume of 0.0074 m³.

Incorporating the above factors, the replacement of produced gas in the Clive reservoir with CO₂ provides storage capacity of:

$$1,250 \cdot 10^6 \text{ m}^3 \cdot (0.0074) \cdot (382 \text{ kg/m}^3) / (\text{tonne}/1000\text{kg}) = 3.5 \text{ MT CO}_2$$

The total CO₂ storage capacity at Clive due to replacement of produced oil and gas is 12.4 MT.

If the current pressure of the Clive reservoir of 1,813 psig is increased to its original discovery pressure of 2,407 psig, the density of CO₂ increases from 382 kg/m³ to 579 kg/m³, or an increase of 51.6%. Thus, the CO₂ storage capacity of Clive is increased from 12.4 MT to 18.8 MT.

Sensitivity to different injectivities, injection strategies, well type (vertical/horizontal) in a multi-well system

The scheme for the storage of CO₂ at Clive is for replacement of oil and gas initially occupying the pore space with CO₂ at abandonment.

The injection rate of CO₂, or the rate of replacement of these fluids with CO₂, is not a consideration to the efficiency of displacement process.

The well type (vertical or horizontal) is a function of injection rate and areal or vertical displacement of the injected fluids within the reservoir. Such considerations (i.e. CO₂ rate and CO₂ placement) are a matter of project economics and do not impact storage capacity.

The injection strategy will be dominated by factors such as CO₂ supply, reservoir geology (structure, porosity, permeability, and hydrocarbon saturations) and capital efficiency.

Pressure management strategy

As the project will be operated at a voidage replacement ratio of one, i.e. fluids produced from the reservoir will be replaced by an equal volume of injected CO₂, therefore the pressure will be unchanged in the system.

SECTION 3 STORAGE		
Section 3.3 Storage sites selection		
Description:	Comparison of the selected storage site to the selection criteria described in Sections 3.1 above. A justification for the candidate selection should be given.	
Purpose:	This information allows for industry and R&D capacity-building within methodology for screening of storage sites.	
Reporting Requirements:	Quantitative Data/Information	Qualitative Knowledge
Before Operation	Comparison of selected storage site to the selection criteria. Summary of reasons for selecting the final site to be further explored: <ul style="list-style-type: none"> - geographical and practical suitability for implementing the whole CCS chain - potential EOR benefits, if considered - governmental regulations/requirements 	Justification for the selection

Quantitative

Comparison of selected storage site to the selection criteria

A summary of publicly available static screening criteria for CCS EOR site selection is shown in the table below. A comparison to Clive is also provided. Such screening criteria are a first step in the site selection process and Clive meets or exceeds all criteria for a suitable site.

Screening Criteria	Acceptable Ranges	Clive Leduc Horizon (selected site)
Reservoir Temperature	>31°C – 121°C	69°C
Reservoir Pressure	>10.3 MPa	13 MPa
Pressure/Minimal Miscibility Pressure	>0.95	1.0
Oil Gravity	27°API - 48°API	38°API
Fraction of Remaining Oil Before CO₂ Flooding	S ₀ > 0.25	0.35
Reservoir Permeability	> 5 x 10 ⁻¹⁵ m ²	>50 md (4.9346165e-14 m ²)
Injectivity	4 – 20 million mcf/injector	>4 million mcf/injector

Summary of reasons for selecting the final site

Practical suitability

There are many practical reasons which make Clive a suitable storage site for CO₂. The Clive reservoirs are mature waterflooded oil reservoirs. In this context, they provide:

- Containment for CO₂ due to the fact that they have contained hydrocarbons for millions of years,
- Capacity for CO₂ storage due to significant production of oil and gas providing voidage,

- Injectivity for CO₂ due to substantial water injection operations for five decades, and
- Residual oil production to provide for economic support of large scale CO₂ sequestration

The Clive reservoirs are also unitized, enabling common ownership and royalty interests across the reservoirs. This provides the opportunity to take advantage of the unique geology, with minimal complications due to competitive ownership interests, in order to maximize oil recovery and maximize sequestration of CO₂.

Geographical suitability

The storage site was also attractive due to its geographic location. As Clive is not adjacent to large residential developments, it makes it easier for surface access to design, build and operate a CCS EOR project with minimal disruptions to residents.

Potential EOR benefits

The potential EOR benefits of CO₂ sequestration sites are an important criteria for consideration in the site selection process. This is due to the fact that the economic gains associated with EOR, and specifically the sale of incremental oil production, will financially support the cost of an expensive CCS scheme.

The EOR benefits extend beyond Enhance. Albertans benefit from this project through increased royalties to the province and job creation. It is estimated that the project will create \$19 billion in royalty revenue for the Alberta government over the next 30 years.

Additional social benefits are created through revitalization of economic activity in a near abandonment oil and gas field. Job creation for the initial ACTL project is estimated at 2,000 direct jobs during peak construction and an additional 8,000 indirect jobs over the life of the project. To date, it is estimated that approximately 132,000 man-hours have been expended by suppliers, contractors and internal efforts. On-going job creation as the ACTL system expands is forecasted to run in the tens of thousands.

Government Regulations and Requirements

The primary regulation that applies to a CCS EOR scheme is ERCB's Directive 065, *Resources Applications for Oil and Gas Reservoirs*. This application is set up to ensure that those wishing to develop oil and gas pools establish a sound technical basis for extraction of such mineral resources. The applicant's plan is reviewed by the ERCB to "ensure that the appropriate level of reservoir engineering and geological science is applied in managing pool wide depletion and that potential impacts on other stakeholders are identified and dealt with fairly."² The Clive CCS EOR project will be subject to such review for approval of its scheme.

Qualitative

Justification for the selection

Clive was chosen as Enhance's CCS site because it met all the above technical criteria as well as economic criteria.

² ERCB Directive 065, page 5

SECTION 3 STORAGE		
Section 3.4 Screening and characterization results		
Description: Site specific data collected to finalize selection of storage site.		
If applicable, describe the exploration activities performed at the selected storage sites along with a discussion as to their purpose, and provide the results of these activities. These activities include data acquisition and interpretation as well as modelling.		
Purpose: This information provides for industry and R&D capacity-building within methodologies for screening of storage sites. Access to data from storage projects is useful for R&D purposes and other analysis. This information is also relevant to stakeholders (local communities, NGOs). In describing the geological storage site, this data is of general interest.		
Reporting Requirements	Quantitative Data/Information	Qualitative Knowledge
During Concept phase/storage site screening	Maps, data and discussion of the selected sites including: <ul style="list-style-type: none"> - well locations and strategy - reservoir location (top depth) and thickness - pressure and temperature - porosity - permeability - injectivity - estimate of the storage potential General geological description of target formation and cap rock. Locations of planned wells/facilities as well as design plan, including injection and monitoring wells and other facilities.	Summary of rationale for site selection If applicable, report describing the exploration activities performed at the selected storage site and characterization results
Data capture frequency	Data captured during the characterization activities Annually and updated as necessary.	

Quantitative

Reservoir Lithology and Mineralogy

The geological description of the Clive reservoirs is taken in part from the Petroleum Society of CIM Paper 83-34-24 Innisfail-Clive-Nevis reef chain revisit by Tsang and Springer.

The Bashaw-Duhamel reef complex is founded on a platform of fragmental limestone of the Cooking Lake formation as shown in a location map later in this section. Slight topographic highs on the platform, possibly caused by localized shoaling, provided focal points for the Leduc D-3 reef growth. The underlying Cooking Lake platform likely provides the common connection for the D-3 pools in the reef complex.

The Leduc formation is a biothermal dolomite, medium to coarse crystalline with large vugs. Porosity is apparently well developed within the reef build-up facies, particularly throughout the reef rim.

Dolomite is a carbonate mineral composed of calcium magnesium carbonate.

The Leduc D-3 is overlain by the impermeable limy green shale of the Ireton formation. The Ireton formation between the Leduc D-3 and the Nisku D-2 zones varies from a thickness of 150m off the reef edge to only a metre.

The Nisku D-2 formation is a dolomitized biostrome reef draped over the underlying Ireton formation and the Leduc reef mass. The hydrocarbon pay zones are comprised of fine to medium crystalline facies, with minor anhydrite and shaly bands. The better porosity development is coincident with the underlying Leduc D-3 reef rim areas, and hydrocarbon accumulations occur in those instances where a trap is formed.

Dolomite is a carbonate mineral composed of calcium magnesium carbonate. The Leduc D-3 is overlain by the impermeable limy green shale of the Ireton formation. The Ireton formation between the Leduc D-3 and the Nisku D-2 zones varies from a thickness of 150m off the reef edge to only a metre.

The Nisku D-2 formation is a dolomitized biostrome reef draped over the underlying Ireton formation and the Leduc reef mass. The hydrocarbon pay zones are comprised of fine to medium crystalline facies, with minor anhydrite and shaly bands. The better porosity development is coincident with the underlying Leduc D-3 reef rim areas, and hydrocarbon accumulations occur in those instances where a trap is formed.

Cap Rocks and Secondary Barriers

A number of formations are considered to be cap rocks and secondary barriers to upward migration of CO₂. As described above, the Leduc D-3 is overlain by the impermeable limy green shale of the Ireton formation. The Nisku is overlain by the impermeable shales of the Calmar formation.

These impermeable cap rock shales are further capped by a very thick Colorado group to Lea Park sediments, consisting of fine grained siliclastics. These laterally continuous cretaceous formations also contain thick and laterally extensive coal zones in the Mannville, Belly River and Horseshoe Canyon formations. These cretaceous sediments and coals act as secondary barriers to CO₂ migration.

Cap Rock Lithology and Minerology

The cap rocks of the Leduc reservoir and Nisku reservoir are the shales of the Ireton and Calmar formations respectively. The sediments of the the Ireton and Calmar are composed of terrigenous clays and silts combined with fine carbonate derived from scattered reefs throughout the area.

Clays are aluminium phyllosilicates or sheet silicates with varying amounts of iron and other cations like calcium, magnesium, potassium, radium, barium etc.

Well location and strategy

Enhance has yet to determine the specific location of its injection wells. However, as stated previously, at the temperature and pressure of the Clive reservoir of 69°C (156°F) and 1813 psig (12,500kPag) respectively, the density of CO₂ is 382 kg/m³ and the density of Clive oil is approximately 715 kg/m³. It is anticipated that gravitational forces will dominate the migration of CO₂.

Therefore, Enhance will locate CO₂ injection wells at the crest of the reservoir in order to maximize its contact with residual oil.

A map showing the structural elevations of the Clive Nisku and Clive Leduc reservoirs is included under the heading of Depth in this section which provides a relative indication of location of injection wells, i.e. at structural highs.

Depth – Reservoir location (top depth)

The Clive reservoir is part of the Devonian Innisfail-Clive-Nevis reef chain. The attached pictorial depicts the relative location of these hydrocarbon bearing pools and the stratigraphy above the Cooking Lake platform.

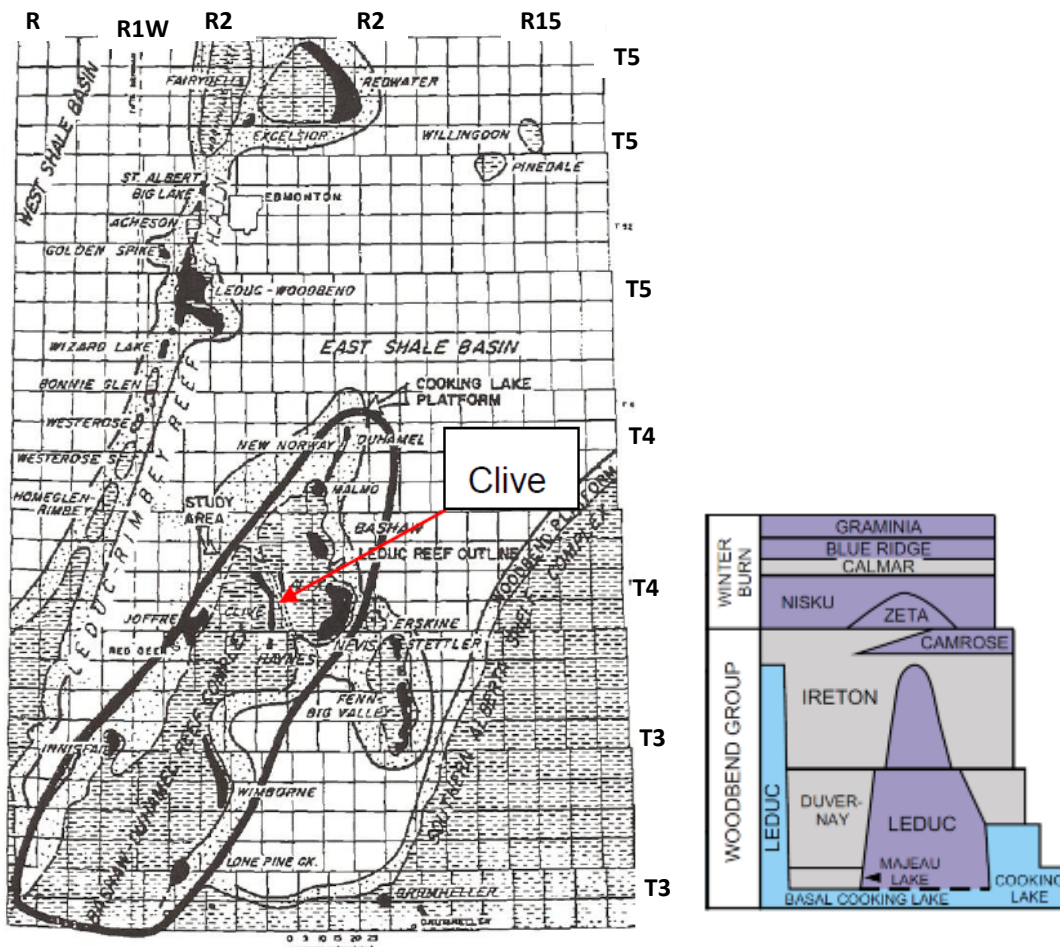

Tsang, G. and Springer, S.J. —Innisfail-Clive-Nevis Reef Chain Revisited, CIM Paper 83-34-24, presented at the 34 ATM of the Petroleum Society, May 10-13, 1983, Banff.

A typical well log in the Clive reservoir is shown below.

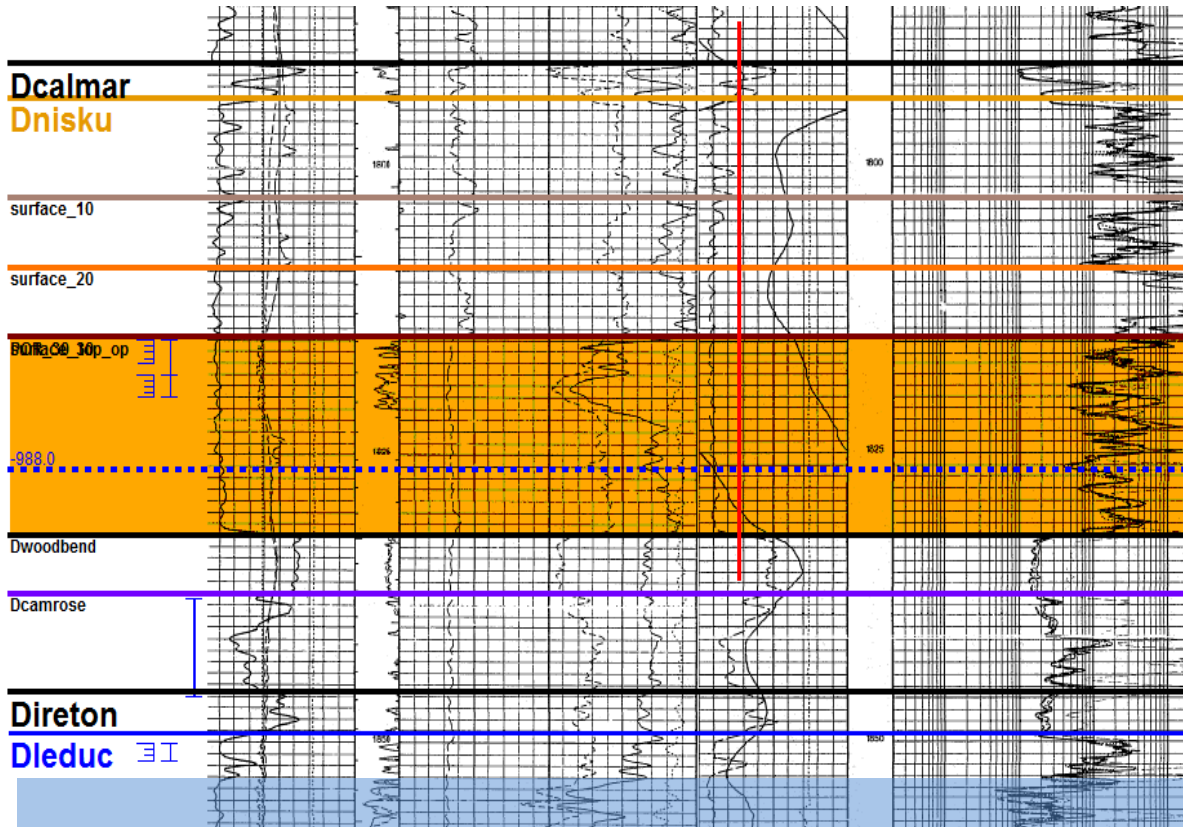

An interpretation of the formation porosity tops results in the following maps:

Nisku Depth Structure

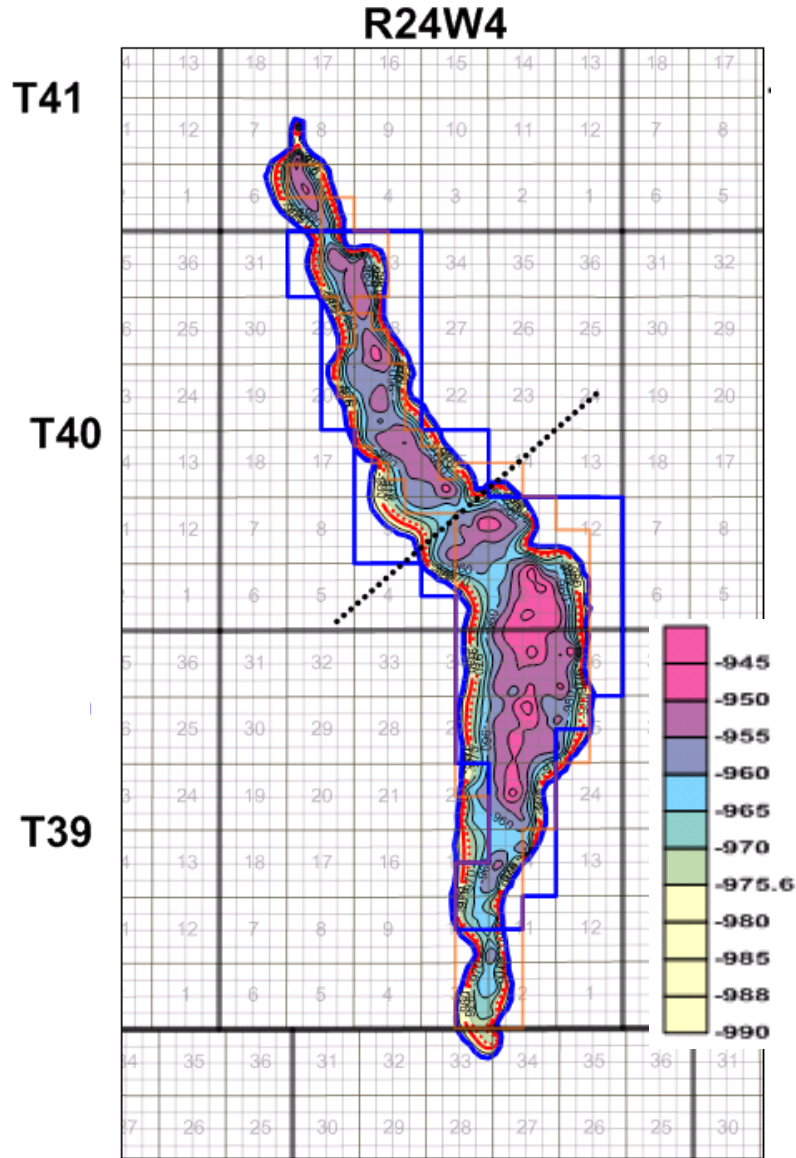

(Units are metres subsea)

Leduc Depth Structure

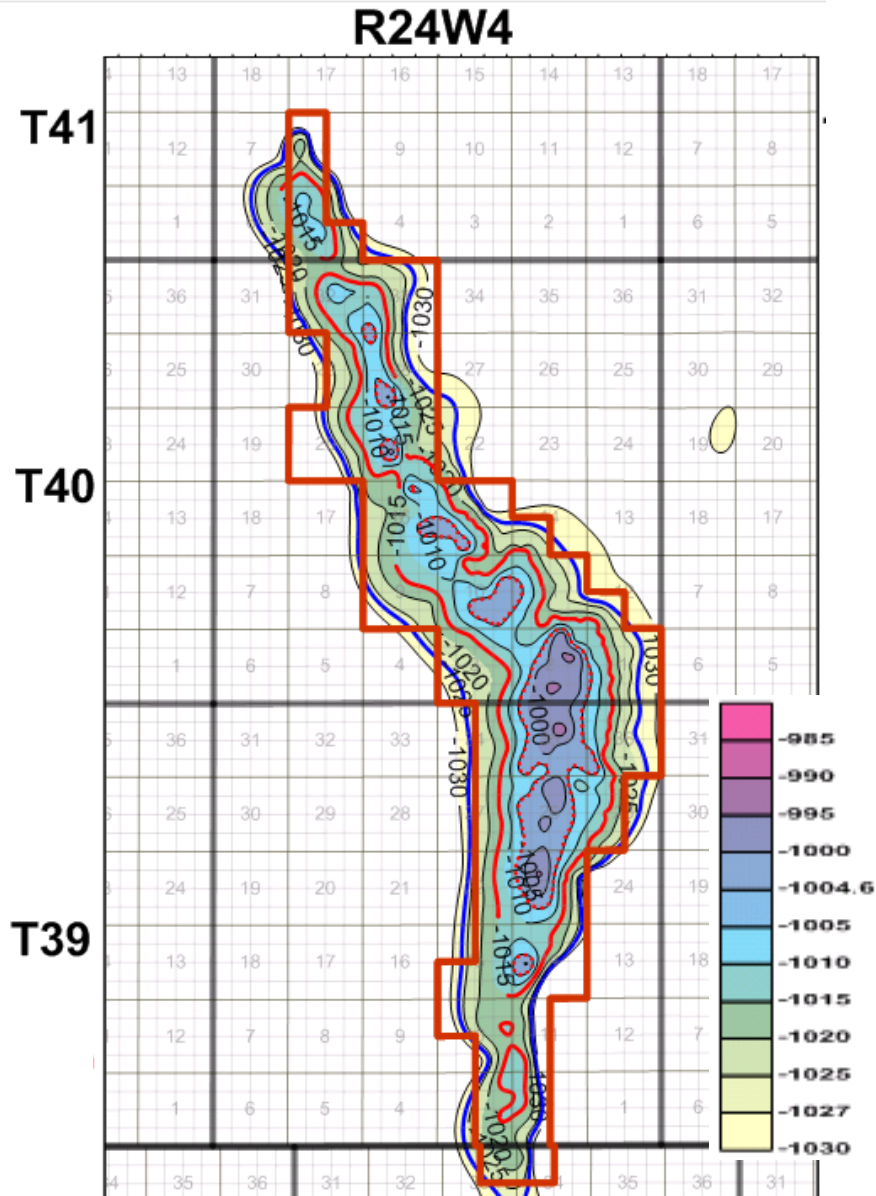

(Units are metres subsea)

Thicknesses

The type log provided under the previous section of 'Depth' was also used to interpret the thickness of the Nisku and Leduc reservoirs and as graphically illustrated below.

Nisku Hydrocarbon Thickness

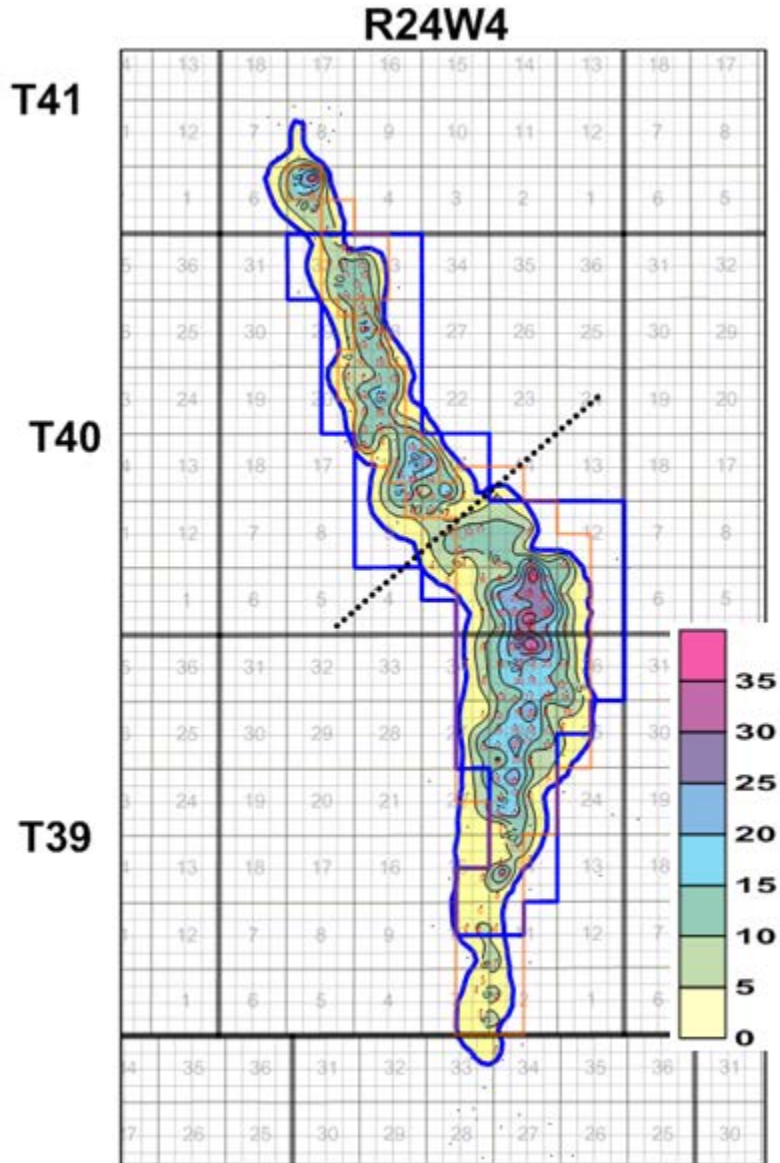

(Units are in metres)

Leduc Hydrocarbon Thickness

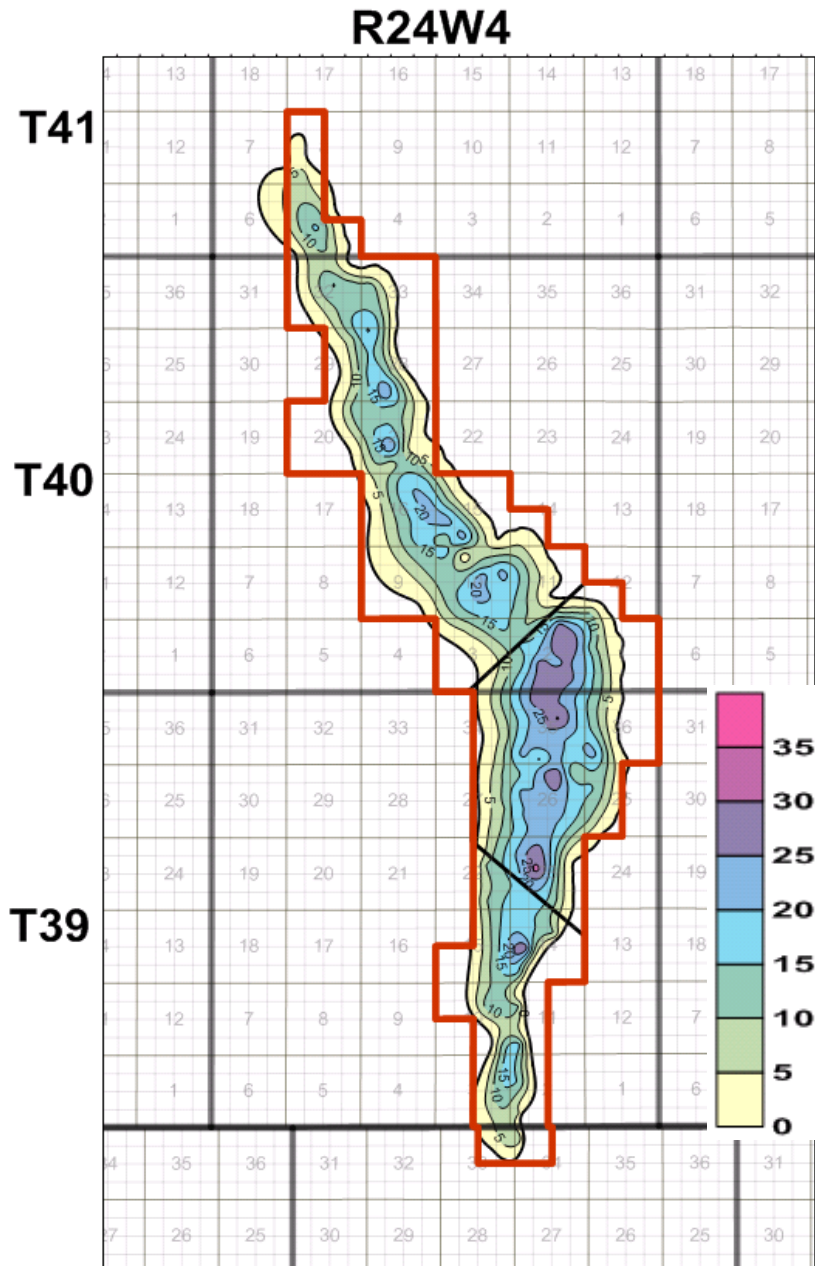

(Units are metres)

Reservoir Pressure and Temperature

The initial reservoir pressure of the Clive Nisku reservoir and the Clive Leduc reservoir was 17,100 kPag (2,480 psig) and 17,500 kPag (2,538 psig) respectively, both at a temperature of 69°C (156°F).

With significant oil and gas production from the Innisfail-Clive-Nevis chain Devonian reefs over the past six decades, the reservoir pressure has declined at constant reservoir temperature as the Cooking Lake aquifer has not been able to provide sufficient influx of water to replace the produced hydrocarbons.

The table below provides a summary of average well pressures obtained in March 2010 from three wells producing from the Leduc and six wells producing from the Nisku.

Clive Pressure Survey March 2010		
Data		
<i>Pressure Survey Zone</i>	<i>Count of Status</i>	<i>Average of Reservoir Pressure (kPag)</i>
Leduc	3	12,892
Nisku	6	12,560
Grand Total	9	12,660

Thus it can be stated with a reasonable degree of confidence that the current reservoir pressure in the Clive Nisku reservoir is 12,560 kPag (1,822 psig) and in the Clive Leduc reservoir is 12,892 kPag (1,870 psig).

Porosity and Permeability

Enhance had contracted a study of the Clive reservoirs in 2008 and in part, an examination was undertaken to determine the porosity, permeability and its interdependence for the Nisku and Leduc reservoirs. The following two graphs are a representation of this analysis.

Nisku Permeability and Porosity Crossplot

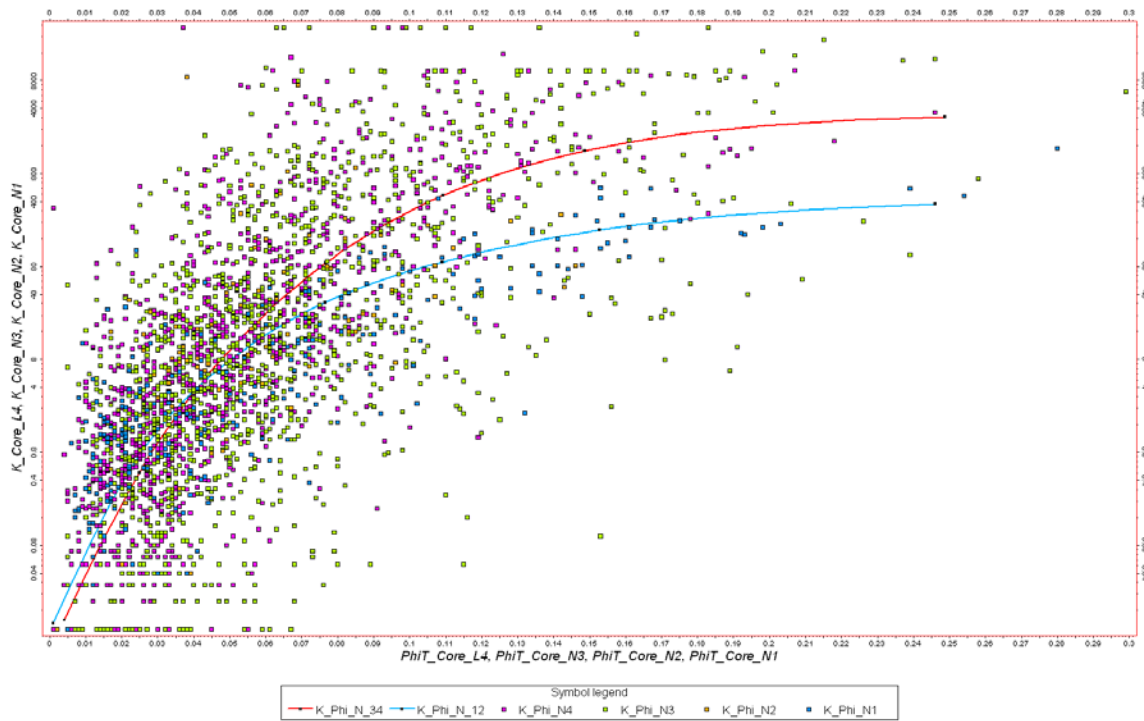

Leduc Permeability and Porosity Crossplot

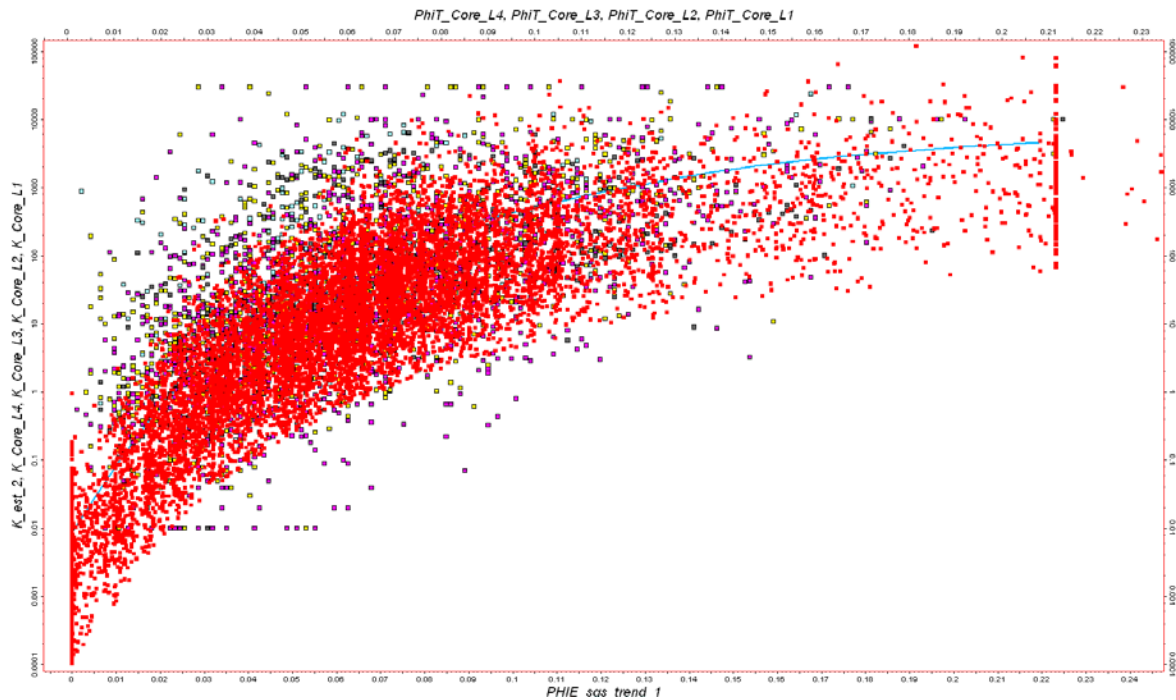

Injectivity

Injectivity of CO₂ is derived from historical injectivity performance of water. Both the Clive Nisku and Leduc reservoirs have shown tremendous capacity for water injectivity. Typical determination of injectivity is based on equivalent volumes at the same reservoir pressure and reservoir temperature.

Generally, 1 m³ of injected surface water occupies a subsurface volume of 1 m³ due to the incompressibility of water. The density of water is therefore approximately 1000 kg/m³. (Note that 1000 kg is equivalent to 1 tonne.)

The temperature and pressure of the Clive reservoir is 69°C (156°F) and 12,500kPag (1,813 psig). At these conditions the density of CO₂ is 382 kg/m³.

To occupy a subsurface volume of 100 m³, the mass of water and CO₂ would thus be 100 tonnes and 38 tonnes respectively. It can be seen from this example that expected CO₂ surface injection rates would be reduced to 40% of the rate observed during water injection operations.

However, water injection wells for the Clive reservoirs have not seen any rate limitations as they have been able to take water on vacuum. Thus, CO₂ injectivity at any Clive reservoir is not expected to be constrained by reservoir parameters but may be impacted by wellbore configuration or surface facility design.

Water Chemistry and Salinity

The following is typical of Clive produced water chemistry and salinity

WATER ANALYSIS					
Analysis 1 of 2					
Well ID:	100/05-28-040-24W4/00	Well Status:	ABD OIL	GL:	857.7m
Well Name:	B.A. CLIVE 5-28-40-24			KB:	861.7m
Dominant Fluid:				TVD:	1898.3m
Formation:	LEDUC FM	Fm Age:	UPPER DEVONIAN (FRASNIAN)	MD:	
Lab :	BRITISH AMERICAN OIL CO LTD			Lab #:	530-63
Date Sampled:	1963/11/19	Received:		Reported:	1964/1/2
Interval A:	1875.7m/1883.7m	Interval B:		Interval C:	
Sample Point:		Description:	OTHER	Test Type:	DST
Sample Pres.:		Rec. Pres.:			
Water Type: Possible formation water acceptable TDS					
Recovery Description: 644' OIL					
TDS 110C:		Density:	1.131@16.00C	Refractive Index:	
TDS 180C:		pH:	6.7	Resistivity of Water:	0.050ohm@25.00C
TDS Ignition:					
TDS Calculated:	196.940Kg/m3				
Organics:					
Remarks:					
APPEARS TO BE FORMATION WATER. ANALYSIS SIMILAR TO OTHER D-3WATERS IN THIS AREA.					
Water Analysis					
Ion	mg/l	MEQ/L	Ion	mg/l	MEQ/L
Na	53099.0	2309.68	Cl	115710.0	3263.76
K			Br	303.0	3.79
Ca	16505.0	823.60	I		
Mg	3565.0	293.36	HCO3	658.0	10.78
Ba			SO4	7100.0	147.82
Sr			CO3		
Fe			OH		
Bo			H2S g/m3		
Mn					

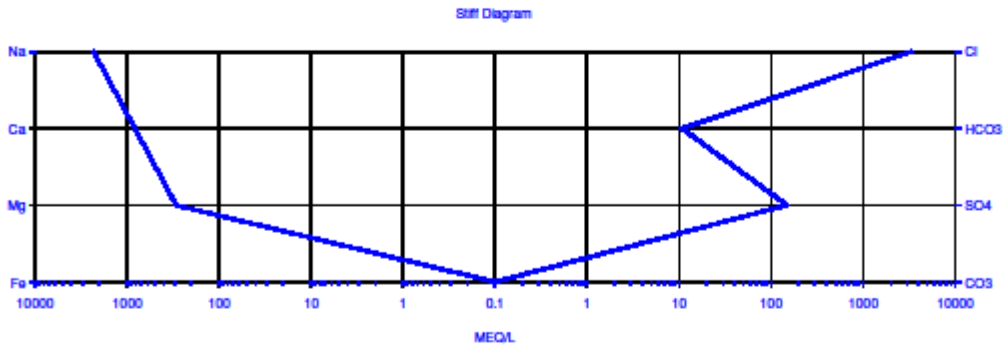

Copyright © 1991-2012, geoLOGIC systems ltd.

Presence of Hydrogen Sulfide

The following is typical of hydrogen content of produced gas from the Clive reservoirs

GAS ANALYSIS									
Analysis 1 of 2									
Well ID:	100/05-28-040-24W4/00	Well Status:	ABD OIL	GL:	857.7m	TVD:	1898.3m		
Well Name:	B.A. CLIVE 5-28-40-24	Meas. Lig. Prod:		KB:	861.7m	MD:			
Dominant Fluid:		Fm Age:	UPPER DEVONIAN (FRASNIAN)						
Formation:	LEDOC FM								
Lab:		Lab File #:		Lab #:					
Date Sampled:	1964/2/3	Received:		Reported:					
Interval A:	1880.0m/1880.6m	Interval B:		Interval C:					
Sample Point:		Description:	OTHER	Test Type:					
Sample Type:		Gas/Liq. Ratio:							
Sample Comment:									
Recovery Description:									
Container ID:		Field Analysis Method:		H2S:	266.2205g/m3				
Loc of H2S Meas.:		Gauge Pressure Separator:		Field H2S:					
Gauge Pressure Received:		Gauge Pressure Treater:		Lab H2S:					
		Mole Free	44.05MJ/m3	Mole & Acid Free	49.531MJ/m3				
		NHV @15C & 101.325kPaA:	40.12MJ/m3		45.057MJ/m3				
		Pseudo Critical Pressure:	5350kPaA/260.2K		6683kPaA/325.0K				
		Relative Density:	0.900		0.825				
		Relative Mole Mass:	0.9002	Vapour Pressure:	109.6kPaA				
		C7+ Fraction:		Density:					
				Mole Weight:					
Gas Composition									
COMP	Air Free	Acid Free	COMP	Air Free	Acid Free	COMP	Air Free	Acid Free	
He	0.02%	0.02%	C2	12.02%	15.02%	C6	0.12%	0.15%	
N2	4.96%	6.20%	C3	8.01%	10.01%	C7	0.08%	0.10%	
CO2	1.42%		iC4	0.89%	1.11%	C8			
H2S	18.53%		nC4	2.07%	2.59%	C9			
H2			iC5	0.35%	0.44%	C10			
C1	51.22%	63.99%	nC5	0.31%	0.39%	Total	100.00%	100.00%	

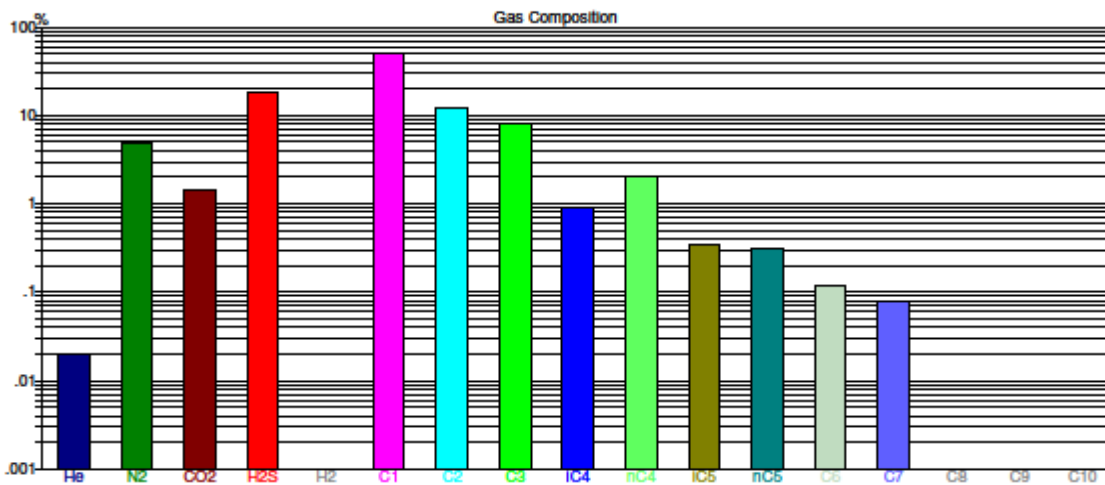

Copyright © 1991-2012, geoLOGIC systems ltd.

Presence of free gas or oil

As the Clive reservoirs are hydrocarbon bearing reservoirs, both the Nisku and the Leduc were discovered at saturation pressure and thus had associated free gas caps overlying the oil bearing strata and underlain, in part, by the cooking lake aquifer. With over 50 years of production and injection operations, the free gas has been produced and replaced by the invading oil and water phases.

Estimate of the storage potential

The CO₂ storage potential at Clive is 18.8 MT, at the discovery pressure of 2,407 psig (16,596 kPag). Please see Section 3.2 for detailed analysis.

Locations of planned wells/facilities as well as design plan

(including injection and monitoring wells and other facilities)

The strategy for location of the CO₂ injection wells will be along the ridge at the top of the structure. Surface processing facilities including CO₂ recycle compression will be located at the Clive battery.

An MMV plan, which will be in place before startup, will be formulated to determine relevant parameters for quantification of safe storage of CO₂. Upon acceptance of this plan and its implementation, the reservoirs may require either shallow and/or deep CO₂ observation wells.

Qualitative

Summary of rationale for site selection

See section 3.3

The exploration activities performed at the selected storage site and characterization results (if applicable)

These activities are not applicable as the site is well developed and a mature oil and gas reservoir.

SECTION 3 STORAGE		
Section 3.5 Baseline monitoring results for shallow groundwater aquifers, soil and air		
<p>Description: These measurements provide a reference that future measurements can be compared against. Description of the monitoring method.</p> <p>The monitoring techniques potentially include:</p> <ul style="list-style-type: none"> - surface gas fluxes and chemical/isotopic composition - soil gas flux and chemical/isotopic composition - ecosystem surveys - groundwater quality (chemical and isotopic composition) - atmospheric quality and composition <p>There are a number of “shallow” geophysical and other techniques that may be appropriate. Depending on the location or season, not all monitoring methodologies may be possible. The selection of measurement techniques are made as part of the MMV process described in 3.11. They may be made in conjunction with the deep baseline measurements. These measurements are made prior to and independently of the monitoring activities described in 3.12.</p> <p>Purpose: This is an essential baseline for measuring any changes in the local environment from CO₂ storage and is important in building confidence in CO₂ storage as safe and without (major) negative effects locally.</p>		
Reporting Requirements:	Quantitative	Qualitative
	Data/Information	Knowledge
Early in characterization of the storage site	Results from baseline monitoring.	Report describing the monitoring techniques

Enhance is currently conducting comprehensive geological and geomechanic studies on the rock (from the bottom of the well to the well head). Once these studies have been completed and analyzed, Enhance will then determine what needs to be monitored and the best techniques to monitor them with.

SECTION 3 STORAGE		
Section 3.6 Baseline monitoring results for the injection horizon		
<p>Description: These measurements provide a reference that future measurements can be compared against. There are four primary suites of measurements: (1) Pressure (and temperature); (2) fluid (water and gas/oil if present) composition; (3) surface imaging (different geophysical methods); and (4) well based imaging (RST, bond logs, etc.). Depending on the monitoring method, a full suite of chemical (mass and/or fraction) and isotopic measurements may be required. Depending on the specific geological structures, aquifers below the injection horizon may have to be sampled/imaged. Under certain circumstances, lateral variation of the data may have to be established.</p> <p>CCS activities include data acquisition and interpretation as well as modelling. Examples of results are:</p> <ul style="list-style-type: none"> - geology/ geophysics/geomechanics/petrophysics/geochemistry/ microbiology - simulation of pressure front migration - use of analogue data - interpretation of monitoring data <p>Depending on the location or season, not all monitoring methods may be possible or cost effective. The selection of measurement techniques are made as part of the MMV process described in 3.11</p> <p>Purpose: This is another essential baseline for measuring injected volume/mass/location of CO₂ in the injection formation. It is important for verification to establish carbon credits or something similar. It is also an essential baseline for measuring any changes in the surrounding environment from CO₂ storage. This is important in building confidence in CO₂ storage as safe and without (major) negative effects locally.</p>		
Reporting Requirements:	Quantitative	Qualitative
	Data/Information	Knowledge
Early in characterization of the storage site	<p>Results from baseline monitoring.</p> <p>Seismic characterization.</p> <p>Initial structural model.</p>	Report describing the monitoring techniques

This requested data is not yet available as Enhance has yet to complete these activities.

SECTION 3 STORAGE		
Section 3.7 Injectivity and draw down tests		
Description: Provide well test description and interpretation.		
Purpose: Industry and R&D competence-building within methodologies for characterizing storage sites is aided by this information. Access to data from storage projects is useful for R&D purposes.		
Reporting Requirements:	Quantitative	Qualitative
	Data/Information	Knowledge
During characterization of storage site	Well test data and information: <ul style="list-style-type: none"> - injected fluid/water/tracer volume, rate and duration for test if necessary - initial pressure build up curve - pressure drop off curve - connected pore volume estimate - rock permeability estimate - other, such as temperature if measured Although not currently envisioned to be needed for the Project, the following well test data and information should be provided in the case that they become relevant to the Project: <ul style="list-style-type: none"> - compartmentalization evaluation - initial water test - injectivity of the water 	Summary report of well tests

Quantitative

As the Clive reservoirs are not an exploration activity but mature producing oil reservoirs with over 60 years of pressure and production history including over 300 wellbores, these reservoirs are extremely well understood from a geological and engineering perspective. Thus, exploratory well test data is not required to characterize a mature productive oil reservoir.

Well test data

Injection Rate

No well tests are planned to determine injectivity as current operations have provided over 50 years of injectivity data for daily rate, cumulative volume and pressure. As all injection wells in the Clive reservoirs operate on a vacuum at the wellhead, there is no reservoir related injection rate limitations. Hence, well test data to determine rate or pressure limitations are not required.

Initial Pressure

The initial discovery pressure of Clive D-3 reservoir in 1952 was 16,594 kPag (2,406 psig) at a datum depth of -1017.8m SL

Pressure Drop Off Curve

A pressure drop off curve is used to determine reservoir transmissibility and near wellbore damage, which are used to determine estimates of injection rate. As the Clive injection wells operate on a vacuum at the wellhead, indicating no reservoir related injection rate limitations, a pressure drop off curve is redundant.

A pressure drop off curve is also used to estimate current reservoir pressure. As there are numerous shut in wellbores with the Clive reservoirs, static gradient surveys on these shut in wells have been used to obtain a significantly better estimate of the current reservoir pressure than those determined by extrapolation from pressure drop off curves.

Connected Pore Volume Estimate

As the Clive reservoirs are mature oil producing, which are very well understood from a geological perspective (wellbore logging, sampling and coring data), geophysical perspective with 3-D seismic data and engineering perspective with over 50 years of production and injection volume history and pressure data, the hydrocarbon connected pore volume estimate is 167 mmbbls. With a 30% connate water saturation, the connected pore volume estimate is grossed up to 239 mmbbls.

Qualitative

A summary report of water injection is attached as *Appendix ix*.

The Clive D-2A and the Clive D-3A injection graphs show the daily water injection volumes and the corresponding number of injection wells. Both reservoirs show tremendous capacity for water injection with peak injection rates exceeding 40,000 bwpd and 50,000 bwpd for the Clive D-2A and Clive D-3A reservoirs respectively.

SECTION 3 STORAGE		
Section 3.8 Planned injection stream composition		
Description:	Identify the planned and observed stream composition of the injection stream of CO ₂ . Assess the risks associated with the impurities identified and the methods to avoid adverse effects of the impurities. Record the evolution of the identified significant risks along with corresponding safeguards as the monitoring activities progresses. Also record the impact of identified risks on the MMV plan in 3.11.	
Purpose:	The composition is relevant to the public in order to know what is being stored in the reservoir and for R&D/industry to understand reservoir behaviour and selection of materials in wells.	
Reporting Requirements:	Quantitative Data/Information	Qualitative Knowledge
Before Operation	Estimated injection stream - expected composition - expected mass flow - expected variation of above factors Assessments: - reactivity of impurities - impact on phase behaviour of impurities - risk and uncertainty assessments - identify safeguards for the significant risks - down-hole water chemistry and composition - required pressure and temperature for injection	Summary report with assessments and lessons learned Summary of risk assessment including ranking of risks and associated uncertainties

Quantitative

Estimated Injection Stream

The following will serve as the minimum requirements for a CO₂ stream for acceptance into the ACTL system:

95 mol percent minimum CO₂

No more than 2 mol% hydrocarbons with a dewpoint not exceeding -20°F

No more than 3 lb/mmscf of glycol or amines or ammonia or methanol

No more than 10 lb/mmscf of water

No more than 4 ppm H₂S by volume

No more than 16 ppm total Sulphur by volume

Less than 1.0% N₂, H₂, CO, AR, or CH₄ each and total inerts less than 4% by volume

Less than 0.1% O₂

Less than 100 ppm SO_x or NO_x by volume

Less than 1 ppb Hg by volume

No solid particles

No free liquids including lube oils or glycol

No material variations from these composition requirements can be accepted into the pipeline.

Mass flow rate

NWR: average 3,500 tonnes of CO₂ per day

Agrium: average 800 tonnes of CO₂ per day

Variation in flow rates is expected in normal pipeline operations, and will vary from 0 tonnes of CO₂ to the maximum contracted supply volumes. These variations are limited to be well within pipeline design specifications.

Assessments

No detailed assessments were done because the injection stream requirements are quite specific and streams not meeting those criteria will not enter the ACTL. Also, with these intentionally specific minimum requirements, impurities must be an insignificant component of the stream so that they do not pose a risk in terms of their reactivity or phase behaviour.

With regard to risk and mitigation strategies, Enhance is currently conducting its risk and uncertainty assessment, and therefore the identification of safeguards for these risks is still currently underway. Down-hole water chemistry and composition are not available at this time.

As for the required temperature and pressure for injection, CO₂ shall be delivered at less than 25°C (77°F) and 2600 psig (17,926 kPag).

Qualitative

Summary reports on lessons learned and risk assessment have not been completed at this stage. As the project progresses there will be more lessons learned to report on, and the risk assessment will be finalized.

SECTION 3 STORAGE		
Section 3.9 Risk Assessment and Safeguard Plans		
Description:	Provide a report covering the conclusions of the risk assessment and describe the action plans for dealing with undesirable events (based on the risk assessment).	
Purpose:	<p>By sharing experiences regarding risks and uncertainties of a geological storage site, industry and R&D competency in characterizing storage sites is increased. The conclusions from risk assessments are important in building public awareness and confidence in geological storage of CO₂.</p> <p>Sharing these experiences developing safeguard plans with other project developers, R&D and other stakeholders is beneficial to current and future CCS projects. This information also helps build confidence among stakeholders, but these plans have to be communicated carefully to the public to avoid misinterpretation.</p>	
Reporting Requirements:	Quantitative Data/Information	Qualitative Knowledge
Before Operation	<p>MMV report, which includes a Risk Assessment</p> <p>Risks addressed based on results of assessment.</p> <p>Describe the corrective and/or preventive measures (mitigation and remediation).</p> <p>Basic cost-benefit analysis.</p>	

Enhance is currently conducting the risk assessment for the project. As this process is still underway, a complete list of risks and corrective and/or preventive measures is not available at this time.

SECTION 3 STORAGE		
Section 3.10 Storage site operation and CO₂ injection		
Description:	Provide information regarding planned injection rates, volumes, operating strategy, HSE and pressure management.	
Purpose:	This information allows for industry and R&D competence-building within development of a geological storage site. Additionally, information of general interest to R&D and industry as part of competence-building on geological storage of CO ₂ is also shared. Openness on what is being injected is essential in building confidence for geological storage of CO ₂ .	
Reporting Requirements:	Quantitative Data/Information	Qualitative Knowledge
Before Operation	Planned injection in total and per well: <ul style="list-style-type: none"> - total rates - total volumes - rates and volumes per injection well - reservoir pressure - pressure at the well head - well-specific injection activity - expected composition Measurement schematic Storage performance forecast.	Report describing operating strategy, HSE, pressure management

Quantitative

Well-specific injection activity

Total rates: Between 100 tonnes and 1,000 tonnes per day per well

Total volumes: up to CO₂ supply of 4,300 tonnes a day

Rates and volumes per injection well: number of wells not yet specified but will be determined based on rates and volumes mentioned above

Reservoir pressure: 1,800 psig. *Pressure at the well head:* not yet determined

Expected composition:

95 mol percent minimum CO₂

No more than 2 mol% hydrocarbons with a dewpoint not exceeding -20°F

No more than 3 lb/mmscf of glycol or amines or ammonia or methanol

No more than 10 lb/mmscf of water

No more than 4 ppm H₂S by volume

No more than 16 ppm total Sulphur by volume

Less than 1.0% N₂, H₂, CO, AR, or CH₄ each and total inerts less than 4% by volume

Less than 0.1% O₂

Less than 100 ppm SO_x or NO_x by volume

Less than 1 ppb Hg by volume

No solid particles

No free liquids including lube oils or glycol

Measurement schematic

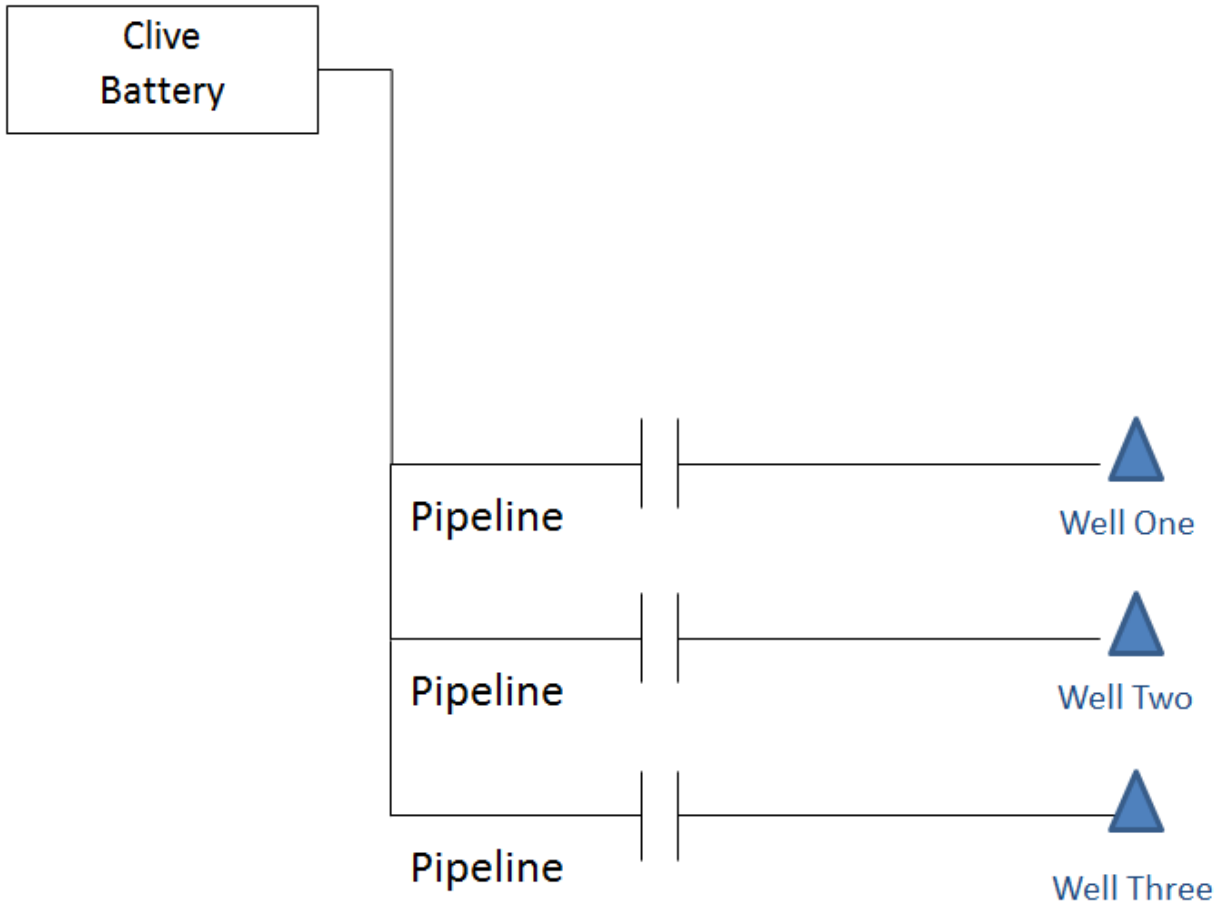

LEGEND



Well

- Each CO₂ injection well will have a dedicated orifice meter to measure injection rates, pressure and temperature.

Storage performance forecast

The total CO₂ storage capacity at Clive is estimated at 18.8 MT of CO₂. (Please see section 3.2 for detailed calculations).

Qualitative

Operating Strategy/Pressure Management

As the scheme is fluid replacement, the average reservoir pressure will remain unchanged. The CO₂ injection wells will be placed along the ridge at the top of the structure.

Health, Safety and Environment (“HSE”)

As the risk assessment and MMV report are still being completed, HSE planning is also still underway. While specific details are not yet in place, Enhance has defined its governing principles. These include an emergency planning zone and emergency plan that will be defined to encompass the operations and to address accidental releases of CO₂, a series of documented operating procedures and comprehensive personnel training.

SECTION 3 STORAGE		
Section 3.11 Monitoring, measurement and verification (MMV) plan and revisions		
Description:	Provide a list of relevant data and information from the MMV plan. The MMV plan should address monitoring during the pre-injection and injection phases, as well as the post injection stages. An overview of revised MMV plan if required by the regulatory agency or by changes in project circumstances.	
Purpose:	Information on planned monitoring is relevant to stakeholders (NGOs, local communities) in building awareness of CO ₂ storage and for R&D/industry to gain knowledge of planning monitoring programs.	
Reporting Requirements:	Quantitative Data/Information	Qualitative Knowledge
Before Operation	Relevant information from the MMV plan: <ul style="list-style-type: none"> - screening of monitoring techniques and technologies for suitability to the selected site - cost-benefit analysis of technically feasible techniques - verification plan - reporting plan Locations of particular importance from a risk viewpoint: <ul style="list-style-type: none"> - description of the site-specific monitoring targets - ground water quality monitoring - leakage surveillance of wells Information mainly relevant for R&D and industry: <ul style="list-style-type: none"> - statement of relevant regulations and precedents List of monitoring techniques considered.	MMV plan and revisions of plan Describe the assessment of monitoring techniques Lessons learned
	Data capture frequency	Annually and updated as necessary

Enhance is currently conducting the risk assessment for the project. The MMV plan is an integral part of this process, and will be created once the risk assessment is finalized. As this process is still underway, an MMV plan is not available at this time.

SECTION 3 STORAGE		
Section 3.12 Monitoring results		
Description:	Specific data to be acquired will be described in MMV plan (see Section 3.11). This plan will be updated regularly throughout the operation phase, particularly during storage permit renewals.	
Purpose:	Information and data from monitoring is relevant to stakeholders (NGOs, local communities) in building awareness of CO ₂ storage. This information also allows for industry and R&D competence-building within monitoring a geological storage site and increased access to data from monitoring.	
Reporting Requirements:	Quantitative Data/Information	Qualitative Knowledge
Before Operation	<p>Actual data from monitoring (techniques described in the MMV plan), may include the following:</p> <ul style="list-style-type: none"> - seismic imaging (e.g., cross-hole tomography, 3D and 4D seismic surveys, VSPs) - chemical tracers - well logs - down hole fluid chemistry - surface gas fluxes (compare to baseline monitoring Section 3.6) - soil gas flux (compare to Section 3.6) - ecosystem surveys (compare to Section 3.6) - tilt meters or equivalent - groundwater (compare to Section 3.6) - atmospheric monitoring (compare to Section 3.6) - static geologic model as a starting model as well as its' input data - from below (case-by-case) the injection unit to the surface - pressure, temperature, fluid saturations - aeromagnetics - passive seismic monitoring for induced seismicity 	<p>Report with assessment of monitoring results Lessons learned from monitoring</p>

This requested data is not yet available as Enhance has yet to complete these activities.

SECTION 3 STORAGE		
Section 3.13 Well design		
Description: The provided data should identify potential risks as well as analysis for potential design improvement. This data should describe the existing and planned wells at the storage sites.		
Purpose: Information shared allows for industry and R&D competence–building, as well as increased access to data from CO ₂ wells.		
Reporting Requirements:	Quantitative Data/Information	Qualitative Knowledge
Before Operation	Type/purpose of well (exploration, monitoring, injection, producer). Trajectory and position. Completion intervals. Casing and cement type and dimensions. Corrosion issues. Other technical specs.	Design rationale Lessons learned

Quantitative

Type/purpose of well

Enhance plans to drill injection wells, whereby CO₂ injected will occupy the same space previously occupied by produced oil.

Trajectory and position

The well trajectory position will be vertical, and their locations, or positions, have not yet been determined.

Completion intervals – Nisku and Leduc horizon

Please see the type log in section 3.4 for the completion interval in the Nisku and Leduc. The completion interval will consist of porous intervals at the top of the structure.

Casing and cement type and dimensions

Enhance’s casing and cement type and dimensions are in accordance with ERCB Directive 051, and are summarized below. The casing size will be standard five and a half inch Oil Country Tubular Goods (“OCTG”) tubular pipe.

Conductor Pipe

- (a) The conductor pipe shall be cemented full length by the circulation method (technique used to ensure that the casing is cemented from bottom to top and insures that the entire annular space fills with cement from below the deepest ground water zone to the surface.).
- (b) If the cement job fails to retain its integrity, then drilling shall be suspended and remedial action undertaken.
- (c) The hole diameter shall be at least 100 mm larger than the diameter of the pipe.

Surface Casing

- (a) Surface casing shall be cemented full length.
- (b) If cement returns are not obtained at surface or the cement level in the annulus drops, then the cement top shall be determined and the appropriate ERCB Area Office contacted to discuss remedial action.
- (c) Fillers or additives that reduce the compressive strength shall not be used in the cement.
- (d) Surface casing shall be adequately centralized at the top and bottom and at 50-metre intervals.

Production, Intermediate, and Liner Casing

- (a) Cement shall not be pumped down the annulus from the surface unless approved by a Board representative.
- (b) The minimum cement top shall be determined as outlined below:
 - a. In all cases if less than 180 meters of surface casing has been run, or casing is not set more than 25 meters below any aquifer which contains useable water, the intermediate or production casing shall be cemented full length. This requirement will take precedence over the required cement top area referred to in the map (below) or on the license.
 - b. Using the example of:

Township: 36, Range: 24, West of the 4th Meridian

the required cement top is “100 meters above the top of the Viking and/or any shallower potential hydrocarbon-bearing zone.”
- (c) The required cement volume shall be based on hole-size measurements, taken from a caliper log, plus a minimum of 20 per cent excess.
- (d) Liners shall be cemented full length
- (e) During the cementing operation, flow returns shall be visually monitored. If cement returns are not obtained at surface when cementing full length, or if displaced drilling fluid returns indicate that a cement-top locating log shall be run. The log and a proposed remedial cementing program shall be submitted to the Board within 60 days of rig release, or prior to commencement of completion operations.
- (f) Full details of the cementing operation shall be recorded and submitted to the Board either on the tour reports or on a casing cement report
- (g) The casing shall be adequately centralized. On intermediate and production casing, centralizers shall be placed at the top and bottom of all productive formations and at 50-metre intervals to the required cement top.

Corrosion issues

The cements used for the project will be resistive to acidic corrosion.

Other technical specs

There are no other technical specs to report at this time.

Qualitative

Design rationale

The well design for the project was created to meet the ERCB directive 051 requirements (as outlined above).

SECTION 3 STORAGE		
Section 3.14 CO₂ injection for EOR only		
Description: Additional information to that in 3.10 , the following data/information is EOR specific.		
Purpose: This information builds competence in industry and R&D on enhanced oil recovery with CO ₂ injection and provides insights into a potential commercial driver for CCS projects.		
Reporting Requirements:	Quantitative	Qualitative
	Data/Information	Knowledge
Before Operation	Estimates of: <ul style="list-style-type: none"> - planned CO₂ injection rates and recycle rates - expected produced gas rates - planned water injection, if applicable. 	
Data capture frequency	Monthly volume	

Quantitative

Planned CO₂ injection rates

As shown in the Clive D-3A historic injection summary graph (*Appendix ix*). The historical average water injection rate for the D-3A pool is approximately 3,600 barrels a day (“Bbl/d”).

The formation volume factor for CO₂ at the current reservoir pressure of 1,813 psi (12,500 kPag) and reservoir temperature of 69°C (156°F) is 0.77 reservoir barrels per mcf. This translates the historical water injection rate of 3,600 Bbl/d to 4,700 mcf/d of CO₂.

Using a conversion factor of 19.65 mcf/t the estimated CO₂ injection rate is 240 t/d per well. At a CO₂ supply rate of 4,300 t/d, this would equate to approximately 18 injection wells.

There is significant variability in the injection capacity of the D-3A. The above is a reasonable approximation of the expected average injection rates. Similarly the D-2A exhibits the same high water injection rate capacity and is expected to show similar behaviour as the D-3A.

Expected production/recycle gas rate

All of the produced CO₂ will be recycled and reinjected into the reservoirs. Analogue pools have typically exhibited long term produced gas rates to equal approximately the injection rate.

Planned water injection

All produced water is currently reinjected and this disposal scheme will continue for the life of the project.

SECTION 3 STORAGE		
Section 3.15 Injection Well Drilling and Completion		
Description: Describe the general methodology of injection well construction work: <ul style="list-style-type: none"> - drilling of wells - drilling work completion - discussion of pre-existing and new well needs (CO₂) - well workovers if existing wells are converted to either injection or monitoring wells 		
Purpose: This description will allow industry and R&D competence-building when developing and operating a geological storage site.		
Reporting Requirements:	Quantitative Data/Information	Qualitative Knowledge
Before Operation	Drilling locations and status of injection Description of well conversion work Map of injection scheme	

Quantitative

Drilling locations and status of injection

The drilling locations have yet to be determined, and injection has not begun.

Description of well conversion work

Enhance has not yet determined the suitability of existing wells for future CO₂ schemes. This work is still being conducted.

Map of injection scheme

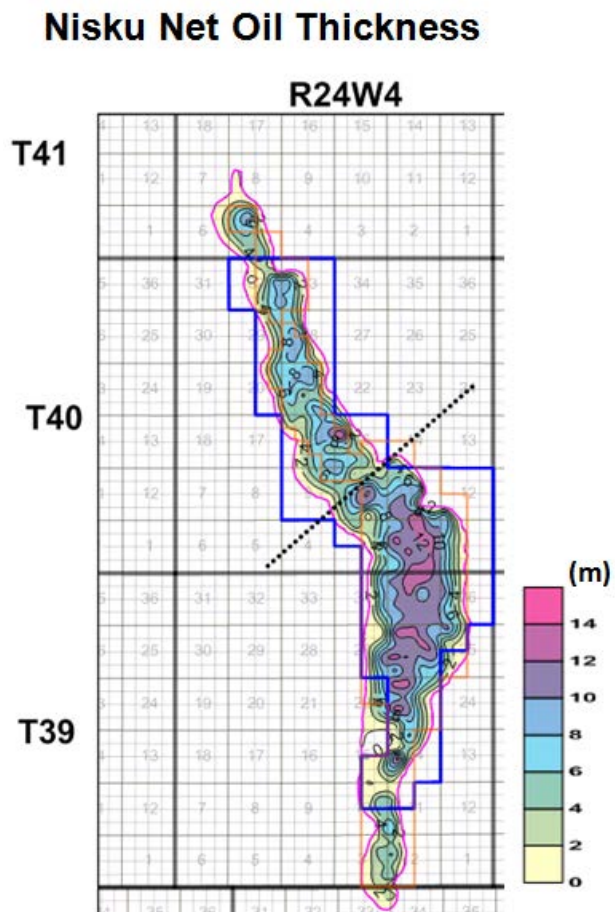
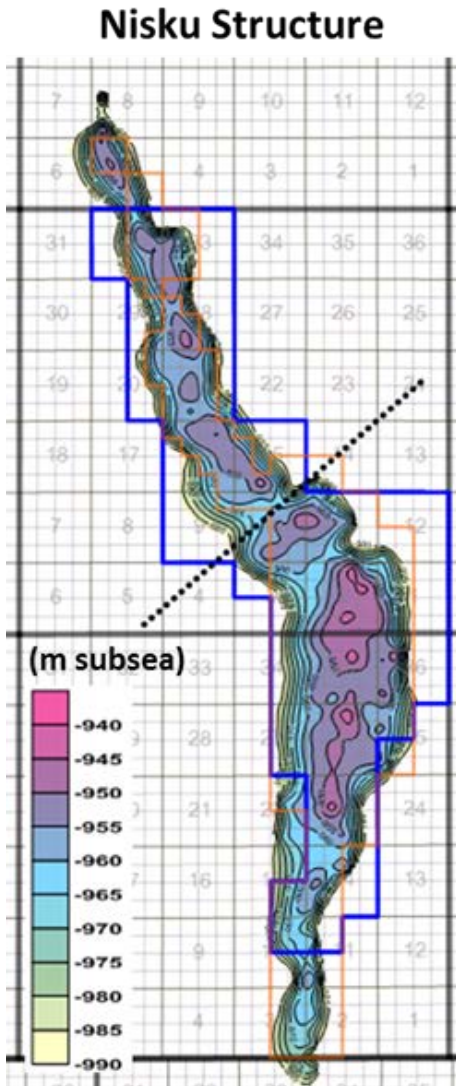

Leduc Structure

R24W4

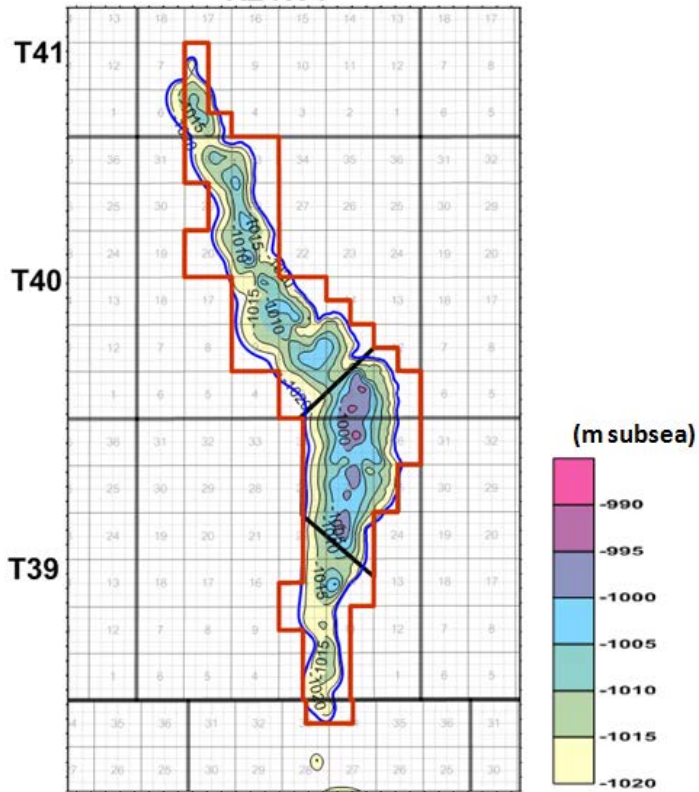

Leduc Net Oil Thickness

R24W4

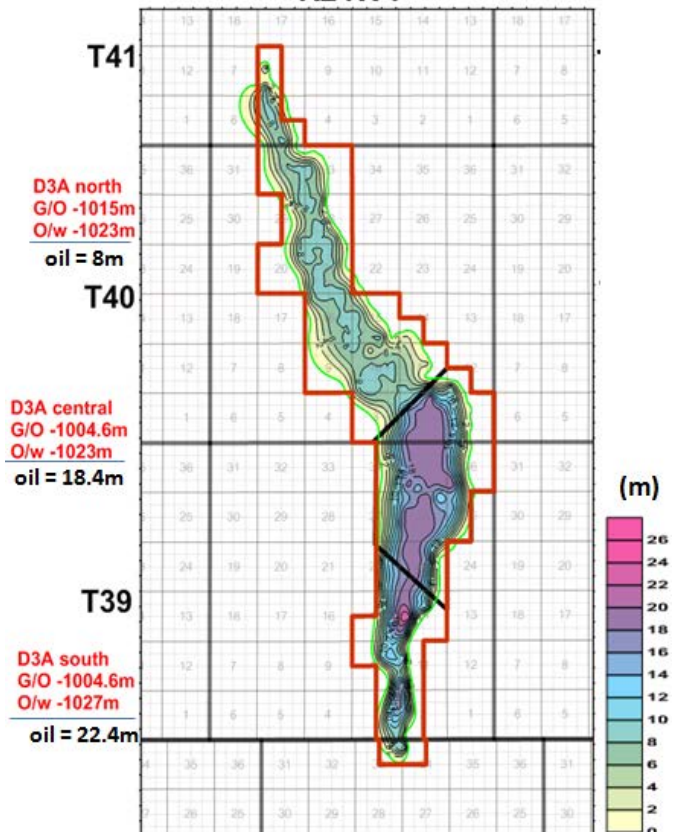

SECTION 3 STORAGE		
Section 3.16 Illustration summarizing site geology and modelling work		
Description: Illustration of site geology and modelling work to highlight key parameters.		
Purpose: Industry and R&D competence building within modeling and monitoring a geological storage site. Access to data/maps.		
Reporting Requirements:	Quantitative Data/Information	Qualitative Knowledge
Before Operation	Illustration/map including: <ul style="list-style-type: none"> - 2D cross sections through structure - stratigraphic columns - Well trajectories of injectors (if deviated). 	
Data capture frequency	Annually and updated as necessary	

Quantitative

The illustrations showing the information required are attached in *Appendix x*.

SECTION 4 CCS VALUE CHAIN		
Section 4.1 Project schedule		
Description:	The project schedule gives information on the status of the project and on each building block (capture, transport and storage) and changes in the plan. The project's critical path and the related tasks need to be identified.	
Purpose:	Sharing schedules are relevant for other CCS projects for benchmarking purposes.	
Reporting Requirements:	Quantitative Data/Information	Qualitative Knowledge
Before Operation	Project schedule overview that identifies milestones for capture, transport, storage, MMV, regulatory components (Gantt Chart or similar).	

Quantitative

Enhance

The project schedule for the Enhance tasks is attached in *Appendix xi*

NWR

The NWR schedule of project milestones is shown below in Table 4.1.1. Carbon capture is expected to commence in 2016.

Table 4.1.1 –Schedule of Project Milestones

NWR Project Schedule - CO ₂ Capture																
Milestone	2013				2014				2015				2016			
	JFM	AMJ	JAS	OND	JFM	AMJ	JAS	OND	JFM	AMJ	JAS	OND	JFM	AMJ	JAS	OND
	1	2	3	4	1	2	3	4	1	2	3	4	1	2	3	4
Detailed Design	█	█	█	█	█	█	█	█	█	█	█	█				
Post Eng. Construction Support				█	█	█	█	█	█	█	█	█	█	█	█	█
Construction First Phase		█	█	█	█	█	█	█	█	█	█	█	█	█	█	█
Piling Complete - Rectisol								▼								
Construction 50% complete- Rectisol								▼								
Mechanical Completion												▼				
Start-up First Phase															█	█
COD - CO ₂ Compression																▼

SECTION 4 CCS VALUE CHAIN		
Section 4.2 Stakeholder dialogue and public awareness		
Description: Document the stakeholder dialogue and consultation process for CCS related activities.		
Purpose: Sharing these experiences is highly relevant to other CCS projects and may help these projects develop a successful stakeholder engagement strategy and stakeholder engagement.		
Reporting Requirements:	Quantitative	Qualitative
	Data/Information	Knowledge
Before Operation	Summary report outlining the stakeholder consultation process and outcomes, including: <ul style="list-style-type: none"> - non confidential list of stakeholders - ongoing stakeholder communications 	

Quantitative

Enhance

Enhance has contacted a total of 1,348 stakeholders.

Below is the non-confidential list of stakeholders.

Companies Contacted	Companies Contacted (Continued)
AB Advertising Associates Inc.	Energy Resources Conservation Board
AB's Industrial Heartland Land Trust Society	Ermineskin First Nation
Academy Petroleum Investments Ltd.	Evonik Degussa Canada Inc.
Access Pipeline Inc.	Fairborne Energy Ltd.
AGCO Agricultural Consulting Ltd.	Fisheries and Oceans Canada
Agrium Inc.	Fort Hills Energy Corporation
Air Liquide Canada	Gwynne Community Church
Alberta Carbon Capture and Storage Development Council, Alberta Energy	Harvest Energy Trust
Alberta Conservation Association	Historic Resources Management
Alberta Energy Research Institute	Historic Resources Management - Land Use Planning
Alberta Department of Environment	Improvement District No. 13 (Elk Island)
Alberta Department of Aboriginal Relations	Indian and Northern Affairs Canada - Alberta
Alberta Department of Culture and Community Spirit	Kinder Morgan Heartland ULC
Alberta Department of Energy	King Tech Maple Resources Inc.
Alberta Department of Finance and Enterprise	Lacombe County
Alberta Department of Municipal Affairs	Public Lands and Forests Division
Alberta Department of Infrastructure	R & S Resource Services Ltd.
Alberta Department of Sustainable Resource Development	R. Stajen Warness, Professional Corporation
Alberta Department of Tourism, Parks and Recreation	RBC Capital Markets

Alberta Natural Heritage Information Centre	Pengrowth Management Limited
ARC Resources Ltd., Corporate Development	Penn West Energy Trust
ATCO Gas and Pipelines Ltd.	Penn West Petroleum Ltd.
BA Energy Inc.	Peters & Co. Limited, Corporate Finance
Bearspaw Petroleum Ltd.	Ponoka County
Beaver County	Praxair Canada Inc.
Beaver County - Public Safety	Provident Energy Trust
Bennett Jones	Royal Tyrrell Museum
Borealis Infrastructure	Shell Canada Ltd, Oil Sands Division
Brookline Public Relations	Shell Canada Ltd.
Calgary and Edmonton Railway Company	SINIS
Camrose County	Statoil Canada Ltd.
Canadian Association of Petroleum Producers	StatoilHydro Canada Ltd.
Canadian Energy Pipeline Association	Strathcona County
Canadian National Railway	Sturgeon County
Canadian Natural Resources Limited	Sunwest Canada Energy Limited
Canadian Pacific Railway	The Alberta Chamber of Resources
Central Community Grounds	The County of Strathcona No. 20
City of Lacombe	The Imperial Pipe Line Company, Limited
City of Fort Saskatchewan	The MD of Sturgeon No. 90
City of Wetaskiwin	Total E&P Canada Ltd.
Ducks Unlimited Canada	Town of Bruderheim
Enbridge Inc.	Town of Lamont
Enerplus Resources Fund, Business Development	Town of Redwater
Lamont County	Town of Tofield
Leduc County	Trans Canada Pipeline Ventures Ltd.
Legislative Assembly of Alberta	Transport Canada
Louis Bull First Nation	Village of Bruderheim
Métis Nation Of Alberta - Region 4	Village of Chipman
Metis Settlements General Council	Village of Clive, Alberta
Montana First Nation	Village of Hay Lakes
North West Upgrading Inc.	Viridian Inc.
NOVA Chemicals Corporation	

On-going Stakeholder Communication – *see Appendix xii*

NWR

Initial Consultation Period (2005-2007)

The commitment to public consultation by NWR for use in project decision making was made in 2005 at the outset of the environmental impact assessment (EIA) and regulatory application process. This commitment was subsequently formalized in the Terms of Reference for the EIA. At that time, CCS solutions for the project were not well advanced. Subsequently, the project was described in regulatory applications and communications with stakeholders as being carbon capture ready with the view that reducing the CO₂ emissions for the project was an important goal.

The local area was defined as a five km radius from the centre of the proposed project site. Landowners, residents and other industry operators within this area were actively informed through direct mail communication of opportunities to be involved in reviewing the project. NWR conducted personal consultations with all stakeholders within the local area, as well as with any person or organization that expressed a direct interest in the project. A confidential stakeholder contact list was prepared and is maintained to facilitate stakeholder communications (see below).

In addition to direct contact, other methods were used to inform stakeholders and the public about the project including:

- Distribution of information with the assistance of Sturgeon and Strathcona Counties;
- Information posted on the project websites;
- Public open houses that were widely advertised in the local area and to the contact list.

Open houses in Redwater, Alberta were held in February 2005 upon public disclosure of the project and in November 2005, after collection of environmental data. The two open houses were attended by over 300 persons representing a range of interests and which generated hundreds of questions and comments. At that time a document of the project's objectives and guiding principles for stakeholder and public involvement was made available.

Issues and concerns expressed by stakeholders were primarily in regards to government policy including the need for new regulatory requirements, municipal land use planning, and civil and other social infrastructure including roads that support anticipated development in the industrial heartland area. NWR has committed to constructively participate with stakeholders, residents, industry and governments in the region to understand their ongoing issues concerns and develop workable solutions.

The ERCB Decision Report 2007-058 (August 7th, 2007) notes that “The Board considers North West’s participant involvement program to be extensive. North West was proactive in its approach to involve the public at the early stages of project development and included both those potentially affected by the proposed project and others who expressed an interest in the project....The board concludes that North West has met and exceeded the Board’s public consultation requirements.”

Post-Project Approval Period (Fall 2007 to present)

Since receiving ERCB approval to build the project, Project personnel have continued stakeholder consultation through the following channels:

- Organizing personal consultations with residents and landowners within five km of the project site. (the stakeholder's name list is confidential)
- Ongoing participation in Community Advisory Panel meetings involving representation of general public members, industry representatives, municipal elected officials and staff from Sturgeon County as well as the towns of Redwater and Gibbons. Meetings are held quarterly and are facilitated by a third party professional. (LTG Consulting of Edmonton)
- Public information sessions where NWR project status, plans and updates are presented, including specific updates on CCS. Events include question and answer sessions where the public can interact with NWR executives for the best information. Such sessions include:
 - Presentations to regional economic development groups for Sturgeon County, Redwater, Gibbons and Fort Saskatchewan. Presentations are typically given annually to each group since 2007.
 - Presentations to "Mayors Update" gatherings, usually attended by 100-200 members of the general public each event. Such presentations are typically given annually to each group since 2007.
- Occasional public newsletters are posted to company websites providing general updated information, and general information related to Carbon Capture plans – note that 2013, 2012 and 2011 newsletters are on the NWR website (www.nwrpartnership.com) while 2008, 2007, and 2006 newsletters are on the NWU website (www.northwestupgrading.com).

NWR is also a participant in multi-stakeholder committees facilitated by Alberta Environment and Sustainable Resource Development (AESRD) related to Cumulative Effects Management in Alberta generally, and the Industrial Heartland area specifically. Most applicable is the Air Management Framework, which NWR has participated in since the framework committee's inception in 2007. Stakeholders who are represented include the federal, provincial, and municipal governments, with participation by their environmental staff experts, as well as NGO's such as Pembina Institute and Toxics Watch, and representatives of companies with facilities within the Industrial Heartland area. CCS is one of the topics discussed, along with emissions of NO_x, SO_x, ozone and PM_{2.5}.

Non-Confidential List of Stakeholders

NWR continues to maintain and expand its contact list and is fully committed to continuing the existing program of stakeholder dialogue and public consultation.

NWR also participated and contributed significantly to the development of "The Water Management Framework for the Industrial Heartland and Capital Region" as part of a multi-stakeholder group including AESRD, local industry, municipalities and the North Saskatchewan Watershed Alliance. This group continues to work with AESRD on developing water criteria for the region.

The NWR Stakeholder contact list includes 348 contacts representing the following interests:

- 56 businesses;
- 14 Community Advisory Panel members sponsored by Evonik, Agrium, Pembina NGL (formerly Provident Energy), Access Pipeline, Suncor Energy (Fort Hills) and NWR;
- 50 municipal, provincial and federal administrators and elected officials;
- 184 landowners and residents; and
- 10 non-governmental organizations (NGOs).

The NWR Stakeholder contact list includes 348 contacts representing the following interests:

- 56 businesses;
- 14 Community Advisory Panel members sponsored by Evonik, Agrium, Provident Energy, Access Pipeline and Suncor Energy (Fort Hills);
- 50 municipal, provincial and federal administrators and elected officials;
- 184 landowners and residents; and
- 10 non-governmental organizations (NGOs).

SECTION 4 CCS VALUE CHAIN		
Section 4.3 Cost per tonnes of CO₂ emissions captured, transported and stored		
<p>Description: Calculate the cost per tonne of CO₂ emissions captured, transported, and stored implementing CCS:</p> <ul style="list-style-type: none"> - include full CCS value chain costs and CO₂ emissions captured, transported, and stored - exclude incremental oil produced by EOR with CO₂ injection <p>Methodologies for calculating cost per tonne of CO₂ emissions have to be harmonized across the CCS projects being funded by the Province for comparison purposes. A capital cost allocation methodology per tonne of CO₂ will be provided by the Province.</p> <p>Purpose: This allows for benchmarking costs of the CCS project with the price of carbon and other measures reducing CO₂ emissions.</p>		
Reporting Requirements:	Quantitative Data/Information	Qualitative Knowledge
Before Operation	Estimated full CCS value chain cost per tonne of CO ₂ emissions captured, transported, and stored by implementing CCS based upon the methodology directed by the Province.	

Enhance and NWR are currently waiting for Alberta Energy to provide their “allocation methodology per tonne” in order to complete this cost estimate.

SECTION 4 CCS VALUE CHAIN		
Section 4.4 Governmental funding		
Description: Yearly governmental funding provided to the project- this is public information.		
Purpose: This information is relevant for industry players for benchmarking purposes		
Reporting Requirements:	Quantitative	Qualitative
	Data/Information	Knowledge
Before Operation	Governmental funding granted: - planned annual and total governmental funding provided to the CCS project - governmental funding relative to the costs incurred to date (percent) Governmental funding profile and forecast (federal and provincial).	

Government Funding	2009	2010	2011	2012	2013	2014	2015	2016 - 2025	TOTAL
Federal ecoETI	\$0	\$15.80	\$14.20	\$2.90	\$0	\$0	\$0	\$0	\$33
Federal CEF	\$0	\$0	\$11.40	\$13.55	\$5.35	\$0	\$0	\$0	\$30
Provincial ACTL CCS Funding	\$0	\$0	\$0	\$4.50	\$0	\$140.30	\$127.63	\$223	\$495
TOTAL	\$0	\$15.80	\$25.60	\$20.95	\$5.35	\$140.30	\$127.63	\$223	\$558

Notes:

- 1) Funding amounts shown above are in \$MM
- 2) Funding represented in the table above for years 2009 – 2012 have been claimed in those periods (minus a 10% holdback on Federal funds), funding amounts for years 2013 onwards are forecast to be claimed in their respective periods.

Enhance Energy

Government funding claimed to December 31st, 2012 as a percentage of eligible cost incurred: 91%

Government funding as a percentage of estimated eligible total costs incurred to December 31st, 2025: 51%

NWR

Government funding claimed to December 31st, 2012 as a percentage of eligible cost incurred: 0%

Government funding as a percentage of estimated eligible total costs incurred to December 31st, 2025: 41%

SECTION 4 CCS VALUE CHAIN		
Section 4.5 CO₂ emissions per year		
Description: Provide information on the CO ₂ emitted from the capture facility, pipelines and storage. Include an overview of sources of fugitive emissions throughout the value chain. Downstream emissions associated with the produced oil in EOR projects are to be excluded, but additional actual onsite CO ₂ emissions created to produce incremental oil should be included. Only the emissions associated with the Project are to be included.		
Purpose: This documents the climate benefit of the CCS project.		
Reporting Requirements:	Quantitative	Qualitative
	Data/Information	Knowledge
Before Operation	<p>Estimated yearly CO₂ emissions from the full CCS value chain (aggregated from CO₂ source, capture, transport and storage).</p> <p>Downstream emissions associated with the produced oil in EOR projects to be excluded, but additional actual onsite CO₂ emissions created to produce incremental oil should be included.</p>	

Enhance

Enhance's estimates for CO₂ emissions per year at both its Agrium CRF site and its NWR CRF main and booster compression sites is shown in the table below.

Agrium CRF	Emissions per year	Units
Energy Consumption	38,960	tCO _{2E} /yr
Natural Gas Consumption	495	tCO _{2E} /yr
Fugitive Emissions	111	tCO _{2E} /yr
Process Emissions	80	tCO _{2E} /yr
TOTAL EMISSIONS	39,646	tCO_{2E}/yr

NWR CRF	Emissions per year	Units
Enhance Energy Booster CO ₂ Compressor – Energy Consumption	70,532	tCO _{2E} /yr
Enhance Energy Booster CO ₂ Compressor – Fugitive Emissions	48	tCO _{2E} /yr
Enhance Energy Main Compressor – Energy Consumption	45,222	tCO _{2E} /yr
Enhance Energy Main Compressor – Fugitive Emissions	89	tCO _{2E} /yr
<i>TOTAL EMISSIONS</i>	<i>115,891</i>	<i>tCO_{2E}/yr</i>

Notes:

- 1) The reproduced CO₂ volumes are gathered from production pipelines and contained within production vessels to separate from produced fluids, transferred in plant piping for compression and reinjection into the reservoir. These CO₂ volumes are commonly referred to as recycle CO₂ and as they are contained within a closed system, these recycle emissions are primarily associated with fugitive emissions from piping connections and venting due to compression upsets. These volumes are negligible.
- 2) Recycle compression is typically associated with large horsepower requirements and is typically provided by electrical driven motors. Thus, there are no additional onsite CO₂ emissions from such electrical motors.
- 3) The trend in operating pressures for oil production systems in CO₂ floods is to operate at higher pressures. Typical Waterflood operations gather produced fluids at 350 kPa and CO₂ operations now gather produced fluids at 3,500 kPa. The electrical load is proportional to compression ratio and this has been significantly reduced with the much higher inlet pressure.

NWR Rectisol®

The estimated yearly CO₂ emissions from the NWR Rectisol® unit are shown in Table 4.5.1.

Table 4.5.1 – Estimated Annual CO₂ Emissions from Rectisol® Unit

CO ₂ Stream	Feed Rate (kg/hr)	Tonnes-CO ₂ /yr
CO ₂ in Rectisol® Raw Feed (based on normal capacity)	154,913	1,357,037
Planned CO ₂ in Rectisol® Raw Feed ¹	n/a	1,256,616
CO ₂ emissions via Crude H ₂ stream	0	2
CO ₂ emissions via Acid Gas stream	4,535	36,787
CO ₂ emissions via Sour Water stream	16	127
Total estimated CO ₂ offgas available for capture	n/a	1,219,700
CO ₂ emissions via CO ₂ Offgas stream (based on storage operating reliability) ²	n/a	24,394
Total estimated CO ₂ emissions to atmosphere	n/a	61,3108

Notes:

- 1) Based on planned refinery availability of 92.6%
- 2) CO₂ Offgas stream emissions are generally caused by downstream off-take curtailment. Offtake annual operating reliability is assumed to be 98%).

SECTION 4 CCS VALUE CHAIN		
Section 4.6 CO₂ emissions avoided		
Description:	Provide information on the CO ₂ that would have been emitted if CCS had not been implemented vs. CO ₂ emitted after CCS implementation. Include capture facility, pipelines and storage. Downstream emissions associated with the produced oil in EOR projects are to be excluded, but additional actual onsite CO ₂ emissions created to produce incremental oil should be included.	
Purpose:	This documents the climate benefit of the CCS project.	
Reporting Requirements:	Quantitative Data/Information	Qualitative Knowledge
Before Operation	Estimated CO ₂ emitted from source if CCS had not been implemented vs. estimated CO ₂ emitted with CCS implemented. Downstream emissions associated with the produced oil in EOR projects to be excluded, but additional actual onsite CO ₂ emissions created to produce incremental oil should be included.	Rationale for estimates

Quantitative

Agrium CRF

The CO₂ emissions avoided at the Agrium site are summarized in the table below.

Scenario	Estimated CO₂ (t/y)
Baseline emissions (CCS not implemented)	292,000
Project emissions (CCS implemented)	39,646
Avoided Emissions	252,354

NWR CRF

The estimated NWR CRF avoided CO₂ emissions described in Section 4.5 are shown in the table below.

Scenario	Estimated CO₂ (t/y)
Baseline emissions (CCS not implemented)	1,256,617
Project emissions (CCS implemented)	61,308
Avoided Emissions	1,195,306

The reproduced CO₂ volumes are gathered from production pipelines and contained within production vessels to separate from produced fluids, transferred in plant piping for compression and reinjection into the reservoir. These CO₂ volumes are commonly referred to as recycle CO₂ and as they are contained within a closed system, these recycle emissions are primarily associated with fugitive emissions from piping connections and venting due to compression upsets. These volumes are negligible.

Recycle compression is typically associated with large horsepower requirements and is typically provided by electrical driven motors. Thus, there are no additional onsite CO₂ emissions from such electrical motors.

The trend in operating pressures for oil production systems in CO₂ floods is to operate at higher pressures. Typical Waterflood operations gather produced fluids at 350 kPa and CO₂ operations now gather produced fluids at 3,500 kPa. The electrical load is proportional to compression ratio and this has been significantly reduced with the much higher inlet pressure.

Qualitative

Agrium

The aforementioned estimates are based on current stack emissions at Agrium.

NWR

The rationale for determining avoided CO₂ emissions is comparison between the project scenario, which includes carbon capture, and the baseline scenario, which does not include carbon capture and where CO₂ emissions are vented to the atmosphere.

SECTION 5 REGULATORY APPROVALS - CAPTURE, TRANSPORTATION, STORAGE & CCS VALUE CHAIN		
Section 5.1 List of standards and rules relevant for the construction of the project		
Description:	List and describe relevant requirements and standards required in the construction of the project and identify any gaps.	
Purpose:	An overview of laws and regulations, standards and rules will be valuable for other CCS projects in Alberta and reduce project lead times. It will also help other stakeholders (NGOs, local communities); transparency is important for public engagement.	
Reporting Requirements:	Quantitative	Qualitative
	Data/Information	Knowledge
Before Operation	List and description of all requirements and standards to be adhered to in the construction of the project: <ul style="list-style-type: none"> - identification of regulatory body for each identified above - identification of additional hurdles encountered 	

Enhance – Standards and Rules

Regulatory Body	Requirement or Standard	Additional Hurdles Encountered
Alberta Energy Resources Conservation Board	Noise Control Directive 38 (Ed. Feb. 16, 2007)	None
Alberta Energy	The Electrical Protection Act	None
Alberta Environment	Land Surface Conservation and Reclamation Act	None
Alberta Environment	Code of Practice for Pipelines and Telecommunication Lines Crossing a Body of Water	None
Alberta Health and Safety	<i>Alberta Occupational Health and Safety Act</i> , General Safety regulations	None

Alberta Transportation and Utilities	Guidelines for Placement of Underground Oil and Gas Pipelines in the Vicinity of Transportation Facilities	None
American Petroleum Institute(API)	Specification for End Closures, Connectors and Swivels	None
American Petroleum Institute(API)	API-1104, Welding Pipelines and Related Facilities	None
American Petroleum Institute(API)	API-1110, Pressure Testing and Related Facilities	None
American Petroleum Institute(API)	API RP-521, Guide for Pressure Relieving and Depressurizing Systems	None
American Petroleum Institute(API)	API 671, Enhance and Tube Exchangers	None
American Petroleum Institute(API)	API 660, Special Purpose Couplings for Petroleum, Chemical and Gas Industry Services	None
American Society of Mechanical Engineers (ASME)	B31.3 Process Piping	None
American Society of Mechanical Engineers (ASME)	Boiler and Pressure Code, code Section VIII, Division 1	None
American Society of Mechanical Engineers (ASME)	Section V, Non-destructive Examination	None

American Society of Mechanical Engineers (ASME)	Section IX, Boiler and Pressure Vessel Code	None
American Society of Mechanical Engineers (ASME)	Section VIII, Welding and Brazing Qualifications	None
American Society of Mechanical Engineers (ASME) / American Standards Institute (ANSI)	B16.5 Pipe Flanges and Flanged Fittings	None
American Society of Mechanical Engineers (ASME) / American Standards Institute (ANSI)	B16.9 Factory-Made Wrought Butt-welding Fittings	None
American Society of Mechanical Engineers (ASME) / American Standards Institute (ANSI)	B 31.3 Forged Steel Fittings, Socket Welded and Threaded	None
American Society of Mechanical Engineers (ASME) / American Standards Institute (ANSI)	B 16.20 Metallic Gaskets for Pipe Flanges - Ring-joint, Spiral Wound and Jacketed	None
American Society of Mechanical Engineers (ASME) / American Standards Institute (ANSI)	B 16.34 Valves - Flanged, Threaded and Welding End	None
American Society of Mechanical Engineers (ASME) / American Standards Institute (ANSI)	B 16.11 Process Piping	None

American Society for Non-destructive Testing (ASNT)	ASNT-SNT-TC-1A Recommended Practice	None
American society for Testing and Materials (ASTM)	ASTM E 138 Standard Specification for Pipe, Steel, Black, Bars and Strips Hot-dipped, Zinc coated, Welded and Seamless	None
American society for Testing and Materials (ASTM)	ASTM A 105 Standard Specification for Carbon Steel Forging for Piping Applications	None
American society for Testing and Materials (ASTM)	ASTM A 106 Standard Specification for Seamless Carbon Steel Pipe for High Temperature Service	None
American society for Testing and Materials (ASTM)	ASTM A 193 Standard Specification for Carbon and Alloy Steel Nuts and Bolts for High Pressure and High Temperature Service	None
American society for Testing and Materials (ASTM)	ASTM A 216 Standard Specification for Carbon Steel Castings Suitable for Fusion Welding for High Temperature Services	None
American society for Testing and Materials (ASTM)	ASTM A 234 Standard Specification for Piping Fittings and Wrought Carbon Steel and Alloy Steel for Moderate and Elevated Temperatures	None
American society for Testing and Materials (ASTM)	ASTM A 269 Standard Specification for Seamless and Welded Austenitic Stainless Steel Tubing for General Service	None
American society for Testing and Materials (ASTM)	ASTM A 320 Standard Specification for Alloy Steel Bolting Materials for Low Temperature Service	None

American society for Testing and Materials (ASTM)	ASTM A 333 Standard Specification for Seamless and Welded Steel Pipe for Low Temperature Service	None
American society for Testing and Materials (ASTM)	ASTM A 350 Standard Specification for Carbon and Low-alloy Steel Forging, Requiring Notch Toughness Testing for Piping Components	None
American society for Testing and Materials (ASTM)	ASTM A 352 Standard Specification for Steel Castings, Ferritic and Martensitic, for Pressure-containing Parts, Suitable for Low-Temperature Service	None
American society for Testing and Materials (ASTM)	ASTM A 370 Specification for Methods and Definitions for Mechanical Testing of Steel Products	None
American society for Testing and Materials (ASTM)	ASTM A 36 Structural Steel	None
American society for Testing and Materials (ASTM)	ASTM A 420 Standard Specification for Piping Fittings of Wrought Carbon Steel and Alloy Steel for Low-temperature Service	None
American society for Testing and Materials (ASTM)	ASTM A 53 Specification for Wet Magnetic Particle Inspection	None
Canadian standards Association (CSA)	CAN/CSA22.3 No. 6-M91 (R2003) Principles and Practices of Electrical Coordination Between Pipelines and Electrical Supply Lines	None
Canadian standards Association (CSA)	CSAZ 662-11 Oil and Gas Pipeline Systems	None

Canadian standards Association (CSA)	CSAZ 245.1-07 Steel Pipe	None
Canadian standards Association (CSA)	CSAZ 245.15-09 Steel Valves	None
Canadian standards Association (CSA)	CSAZ 245.12-09 Steel Flanges	None
Canadian standards Association (CSA)	CSAZ 245.11-09 Steel Fittings	None
Canadian standards Association (CSA)	CSAZ662-07 Oil and Gas Pipeline Systems	None
Canadian standards Association (CSA)	CAN/CSAZ245.20 / CAN/CSAZ245.21 External Fusion Bond Epoxy Coating for Steel Pipe / External; Polyethylene Coating for Pipe	None
Canadian standards Association (CSA)	C22.1 Canadian, Electrical Code	None
Canadian standards Association (CSA)	CAN3-S16.1, Steel Structure for Buildings (Limit States Design)	None
Canadian standards Association (CSA)	CSA B51-M1991, Boiler, Pressure Vessel and Pressure Piping Code	None

Canadian standards Association (CSA)	CAN/CSA 3-A-A23.1-M Concrete Materials and Method of Concrete Construction	None
Canadian standards Association (CSA)	CAN/CSA3-A23.2-M Methods of Test for Concrete	None
Energy Resources Conservation Board (ERCB)	Alberta Pipeline Act	None
Energy Resources Conservation Board (ERCB)	The Oil and Gas Pipeline Surface Operation Regulations	None
Fisheries and Oceans Canada (DFO)	Water Crossing Regulations	None
Government of Alberta, Agriculture and Rural Development	Public Lands Act and Regulations	None
Government of Alberta, Municipal Affairs	Alberta Building Code	None
Government of Canada, National Building Code of Canada (NBC)	National Building Code	None
International Society of Automation (ISA)	ISA Standards and Recommended Practices for Measurement and Control	None
Manufacturers Standardized Society (MSS)	MSS SP-6 Standard Finishes for Contact Facets for Pipe Flanges and Connecting	None

Manufacturers Standardized Society (MSS)	MSS SP-44 End Flanges of Valves and Fittings Steel Pipeline Flanges	None
Manufacturers Standardized Society (MSS)	MSS SP-53 Quality Standard for Steel Castings and Forging for Valves Flanges and Fittings and Other Piping Components - Magnetic Particle Examination Method	None
Manufacturers Standardized Society (MSS)	MSS SP-75 Specification for High Test Wrought Welding Fittings	None
National Fire Protection Association (NFPA)	National Electrical Code	None
National Fire Protection Association (NFPA)	Flammable and Combustible Liquids Code	None
Steel Structure Painting Council (SSPC)	SSPC-SP-6 Commercial Blast Cleaning	None
Steel Structure Painting Council (SSPC)	SSPC-PA-1 Shop Field and Maintenance Painting	None

NWR – Standards and Rules

REGULATORY BODY	REQUIREMENT OR STANDARD	UPDATE/NOTES
Alberta Culture and Community Services	Historical Resources Act	None
Alberta Energy Resources Conservation Board	ERCB Directive 055 Storage Requirements for the Upstream Petroleum Industry (Latest release: December 2001; Addendum released: October 10, 2011)	Alberta Energy Regulator (AER) now acting in place of ERCB
Alberta Energy Resources Conservation Board	ERCB Directive 038 Noise Control, Feb 16, 2007	AER as above
Alberta Energy Resources Conservation Board	ERCB Directive 051 Injection and Disposal Wells - Well Classifications, Completions, Logging, and Testing Requirements, March 1994	AER as above
Alberta Energy Resources Conservation Board	ERCB Directive 060 Upstream Petroleum Industry Flaring, Incinerating, and Venting Nov 3, 2011	AER as above
Alberta Energy Resources Conservation Board	ERCB Directive 071 Emergency Preparedness and Response Requirements for the Petroleum Industry Revised edition November 18, 2008	AER as above
Alberta Energy Resources Conservation Board	ERCB Interim Directive ID 2001-3 SULPHUR RECOVERY GUIDELINES FOR THE PROVINCE OF ALBERTA, August 29, 2001	AER as above
Canadian Association of Petroleum Producers <i>(Note – CAPP is an industry association, not a regulatory body)</i>	Best Management Practices for the Management of Fugitive Emissions at Upstream Oil and Gas Facilities, Canadian Association of Petroleum Producers (CAPP) 2007-003, as amended	None
Alberta Environment and Sustainable Resource Development	Guideline for Secondary Containment for Above Ground Storage Tanks, 1997 as amended	None
Alberta Environment and Sustainable Resource Development	Hazardous Waste Storage Guidelines 1988	None
Canadian Council of Ministers of the Environment	Environmental Guidelines for Controlling Emissions of Volatile Organic Compounds from Aboveground Storage Tanks, CCME-EPC-87-E, as amended,	None
Canadian Council of Ministers of the Environment	National Emission Guideline for Commercial/Industrial Boilers and Heaters, CCME-PN 1286, as amended	None

Canadian Council of Ministers of the Environment	Environmental Code of Practice for the Measurement and Control of Fugitive VOC Emissions from Equipment Leaks, CCME-PN 1106, as amended	None
Alberta Environment and Sustainable Resource Development	CONTINUOUS EMISSION MONITORING SYSTEM (CEMS) CODE 1998	None
Alberta Municipal Affairs Safety Codes Council	SAFETY CODES ACT PERMIT REGULATION Alberta Regulation 204/2007	NWR is now accredited to administer regulations under Building, Electrical, Plumbing, Gas and Fire disciplines under the Safety Codes Act for the Project
Alberta Municipal Affairs	Alberta Building Code 2006	As above, accreditation now held by NWR
Alberta Environment and Sustainable Resource Development	Temporary Field Authorization Guidelines Seventh Edition April – 2011	None
Industry Canada	Industry Canada Radiocommunication and Broadcasting Antenna Systems (Formerly CPC-2-0-03 - Environmental Process, Radiofrequency Fields and Land-Use Consultation), January 1, 2008	None
Alberta Environment and Sustainable Resource Development	Alberta Stack Sampling Code, 1995	None
Alberta Environment and Sustainable Resource Development	Alberta Ambient Air Quality Objectives and Guidelines, February 2013	None
Alberta Environment and Sustainable Resource Development	Alberta Air Monitoring Directive, 1989	None
Transport Canada	CARS 2012-1 Standard 621 – Obstruction Marking and Lighting	None

SECTION 5 REGULATORY APPROVALS - CAPTURE, TRANSPORTATION, STORAGE & CCS VALUE CHAIN		
Section 5.2 List of consents/permits relevant for the construction and operation of the project		
Description:	List regulatory requirements that have been granted or are needed to be obtained for the construction and operation of the project.	
Purpose:	An overview of consents/permits and approvals will be valuable for other CCS projects in Alberta and reduce project lead times. It will also help other stakeholders (NGOs, local communities); transparency is important for public engagement.	
Reporting Requirements:	Quantitative	Qualitative
	Data/Information	Knowledge
Before Operation	List and description of all consents/permits and approvals submitted and received during the year including: <ul style="list-style-type: none"> - identification of regulatory body for each identified above - general timelines of receiving approval of these items - identification of additional hurdles encountered while applying 	

Enhance – Consents/Permits

Consent/Permit	General Timeline of Approval Receipt	Additional Hurdles Encountered
Canadian Environmental Assessment Agency (“CEAA”)	Submitted: January 2010 Approved: September 7 th , 2010	None
Development Permit (County Level)	Currently finalizing submission for Agrium Typically two months from submission for review and approval	None
Alberta Historical Resources Foundation (“AHRF”)	Currently preparing application Typically three months from submission for review and approval	On-going routing changes delayed application process
ERCB Directive 56 Pipeline Installation Approval (includes Alberta Environment approval)	Public consultation process: October 2008 – March 2009 Applied: March 20, 2009 Approved: April 26, 2011 License Number: 53252	On-going consultation required after approval
Conservation Reclamation Plan (Alberta Environment)	Submitted: March 18 th , 2009 Approved: April 17 th , 2013	None

NWR – Consents/Permits

BODY/ACT/REGULATION	APPROVAL/PERMIT/DESCRIPTION	UPDATE/NOTES
Energy Utilities Board (now ERCB)/Oil and Gas Conservation Act/	Upgrader Approval No. 10994 dated September 6, 2007 / For construction and Operation of an oil sands bitumen upgrader, no expiry	Approval has been transferred to North West Redwater Partnership Holdings Corp. from North West Upgrading Inc.
Energy Utilities Board (now ERCB)/Oil and Gas Conservation Act	Decision 2007-058 dated August 7, 2007 / Application to Construct and Operate an Oil Sands Upgrader in Sturgeon County. NOTE that this is a DECISION document respecting public interest determination, and is NOT an approval, so transfer to NWR - Newco should not be required	None
Alberta Environment (now Alberta Environment and Sustainable Resource Development)/Environmental Protection and Enhancement Act	Approval No. 217118-00-00 dated September 20, 2007 to construct, operate and reclaim upgrader, as amended by Approval No. 217118-00-01 dated February 13, 2008, and as amended again by Approval No. 217118-00-02 dated December 04, 2012. Approval expires September 1, 2017	Amendment application submitted Dec 2013 for administrative matters and minor technical updates. DRAFT Approval received as at March 13, 2014. Approval is being transferred to North West Redwater Partnership Holdings Corp from North West Upgrading Inc.
Alberta Environment (now Alberta Environment and Sustainable Resource Development)/Water Act	Approval No. 00227771-00-00 as amended by Approval No. 00227773-00-00 dated February 13, 2008 and as amended again by Approval 00227771-00-01 dated October 15, 2012 to divert of water from site Precipitation and North Sask River for process. Approval expires September 1, 2017	Amendment application submitted Dec 2013 for increase to Phase 1 water use (no increase over 3 phases), as well as groundwater management procedures. Approval expected summer 2014

<p>Sturgeon County/Land Use Bylaw 819/96</p>	<p>Development and Building Permits (Various expiry dates, each valid for one year from date of issue, until initiated, then valid to completion – NOTE each has been extended as required during project inactivity period, with expiry now ranging from Q4/13 through Q1/14) 305-07-D0347 305-07-D0399 305-07-D0609 305-07-D0610 305-08-D0001 305-07-D0611 305-07-D0631</p>	<p>Development Permits numbered 305-07-D0611 and 305-07-D0631 have been relinquished as no longer required. All other Development Permits have been initiated and remain valid through to completion of Phase 1</p>
<p>Sturgeon County/The Inspections Group Inc/Safety Codes Act and Codes</p>	<p>Permit No. 305305-11-E0300 as issued Nov 24, 2011 for temporary electrical connection of construction trailers and facilities. Expires upon removal of temporary facilities</p>	<p>North West Redwater Partnership applied for and is approved by the Safety Codes Council to administer Safety Codes Act approvals required for the Project as at May 2013</p>
<p>Alberta Transportation/Highways Development and Protection Act</p>	<p>Roadside Development Permit 2511/049/10. Expires one year from issue, and has been extended as required per project delay. Note that there is another Roadside Development Permit applicable to Range Road 220 modifications, but that has been issued to Sturgeon County as the ‘owner’ of the road allowance</p>	<p>RDP 2511/049/10 has been extended as required to complete the approved scope. Alberta Transportation has issued RDP 2511/310/13 in respect of the complete construction and operation of Phase 1 of the Project</p>
<p>Alberta Sustainable Resource Development/Public Lands Act</p>	<p>Temporary Field Authorization for water course realignment TFA 126500 as issued November 19, 2012. Expires April 15, 2013</p>	<p>TFA 134963 was issued Jul 22 2013 extending water course realignment authorization to June 30 2014, by which time the scope is scheduled to be</p>

		complete
Alberta Community Development/ Historical Resources Act	Clearance Letter (note that his resulted in the ERCB Public Interest Determination, and these clearance letters should not require re-issue to NWR – Newco) Release Date: February 1, 2006 Release Date: November 29, 2006	No Change
Industry Canada/Radio Communication Act and Regulations	Mobile radio licence for use by construction workforce – Such Licences are already issued to NWR, not NWU, as they were issued recently enough to be done through the Partnership	No Change
Energy Resource Conservation Board	Pipeline licences for lines across North Saskatchewan River as per recent Bennett Jones assistance re applications. Have been issued to NWU	All required Pipeline Licences have been transferred to North West Redwater Partnership Holdings Corp. from NWU

Note: Permits with expiry dates prior to initialization will be reapplied for as required to meet the construction schedule

SECTION 6 ECONOMICS – CAPTURE, TRANSPORTATION, STORAGE & CCS VALUE CHAIN

Section 6.1 CAPEX and OPEX

Description: Full CCS value chain investment should be reflected. Capital and operational cost estimates on CO₂ capture, with consistent methodology for all projects, should be provided. Break down of cost structure: capture technology and utility systems (technology building blocks). Estimates on the total capital cost and total yearly operational cost of the pipeline are required. The interfaces between capture and pipeline, and between pipeline and storage, have to be clearly defined. Estimates on the total capital cost and total yearly operational costs of storage sites including surface facilities and injection wells are required.

Purpose: It is important to get real cost data available in the public domain. This is relevant for benchmarking different technologies in other CCS projects and for informing the public of the cost of capturing CO₂. It is also relevant for benchmarking different technologies and project costs. This information will also inform stakeholders, industry and R&D of the total cost of a full CCS project.

Reporting Requirements:	Quantitative	Qualitative
Before Operation	<p>Capex estimates for the capture facility, pipeline, and storage site including facilities and injection wells and full CCS value chain can be broken down into:</p> <ul style="list-style-type: none"> - capture technology - compression facilities for each source - transportation system - storage surface facilities, injection wells and monitoring program <p>Report on the estimated Canada industry content relative to foreign content (in percent of total Capex)</p> <p>Opex estimates for capture facility (expressed as \$/tonne CO₂ captured), pipeline and storage operation can be broken down into:</p> <ul style="list-style-type: none"> - cost of steam and cost of electricity (per MWh) - total cost of all chemicals used (including solvent replacement cost) and waste disposal - labour and administration - maintenance costs - turnarounds - direct vs. indirect costs - total operating spending profile for capture facility, pipeline and storage (separately) 	<p>Rationales for the financial estimates of the capture facility, and the full value chain</p> <p>Explain impacts upon base facility</p> <p>Report lessons learned</p> <p>Impact of foreign exchange on hedging activities</p>

Enhance Operating Cost

The operating cost estimates were developed based on experience and typical operating practices in Western Canada. The major cost for the compression facilities is the required power for compression of the CO₂ from very low pressure to ACTL line pressure. The power costs were calculated using forward power pricing strips provided by power marketers, and the known

electrical requirements for the operation of the facilities. Maintenance expense assumptions were provided by vendors (based on previous operating history). The human resourcing plan was developed with experienced personnel to ensure adequate resources were allocated to operate the facilities (compression, pipeline and CO₂ injection).

Compression	Annual Average Cost
Agrium CRF	
Electricity (\$/MWh)	\$ 81
Total Variable (\$/tonne CO ₂ captured)	\$ 10
Total Maintenance and Turnaround (\$/tonne CO ₂ captured)	\$ 4
Total Fixed (\$/tonne CO ₂ captured)	\$ 5
NWR CRF (Booster and Main Compression)	
Electricity (\$/MWh)	\$ 83
Total Variable (\$/tonne CO ₂ captured)	\$ 10
Total Maintenance and turnaround (\$/tonne CO ₂ captured)	\$ 1
Total Fixed (\$/tonne CO ₂ captured)	\$ 1
Pipeline	
Electricity (\$/MWh)	\$ 81
Total Variable (\$/tonne CO ₂ captured)	\$ 0.4
Total Maintenance (\$/tonne CO ₂ captured)	\$ 1
Total Fixed (\$/tonne CO ₂ captured)	\$ 5
Clive	
MMV (\$/tonne CO ₂ captured)	\$ 2
Injection Well Maintenance (\$/tonne CO ₂ captured)	\$ 1

Note: the costs are broken down in this manner during the planning stages, but that may change once the project is operational.

Cost estimates of chemical used, waste disposal, and labour and administration operational expenditures are estimated as part of variable and fixed costs numbers represented in the operating cost table above. Certain of these costs are too immaterial to be projected individually at the pre-operations stage. As the project moves into operations, the actual costs will be reviewed and may be accurately segregated for reporting where feasible.

Capital Costs

The capital cost estimates listed below vary in estimation accuracy due to the fact that each component of the project is at different levels of development. The overall project cost estimate is Class III (low -10% to -20%, high +5% to +20%).

The Agrium CRF and Pipeline cost estimates are at a Class II level (low -5% to -15%, high +5% to +20%), as the project components have been fully defined and detailed engineering has been significantly completed. The major equipment and materials have been procured for the Agrium CRF, with only the construction contract yet to be awarded. Right of Way and valves have been procured for the pipeline, with budgetary pricing confirmed for the pipe material and construction costs.

The NWR CRF cost estimate is at a Class III level, with the project, process and equipment defined and budgetary pricing received from compressor vendors.

The Clive CO₂ Injection cost estimate is also at a Class III level, with the project, process and equipment defined, and factored cost estimates based on previous operating experience.

Capital Cost Estimates	CAD \$MM
Agrium CRF	\$ 45
NWR CRF (Booster and Main Compression)	\$ 60
Pipeline	\$ 245
Clive CO ₂ Injection	\$ 100
Total	\$ 450

Canadian Content

Being a small Alberta based company; Enhance has always been committed to supporting more Alberta businesses. Direct efforts have been made to keep the majority of work in the Province. The majority of equipment for the pipeline and the large equipment for the Agrium CRF were procured for the project within the Province.

Enhance bought two pieces of equipment from Ontario. Unable to find manufacturers for the inlet condenser and the CO₂ Booster Pump in Alberta, Enhance preferred to have a Canadian supplier for these pieces so as to extend as much benefit as possible to Canadians.

One piece of equipment that Enhance has had to order for the project from outside of Canada is the six-stage compressor for the Agrium CRF, which is being designed in Germany by Siemens. This technology is very specialized and narrow in scope and application. As such, only a handful of vendors in the world are capable of providing such equipment.

A specific percentage of estimated Canadian industry content relative to foreign content is not stipulated in the report as it is a commercially sensitive ratio at the current time. Enhance and NWR have not issued bids on all of the equipment required for the project. Until the ACTL project is further along, and all of the procurement decisions have been made, an accurate ratio for Canadian industry content relative to foreign content cannot be reported.

NWR Rectisol®

NWR Rectisol® Unit

The Rectisol® unit co-produces H₂, CO₂ and H₂S product streams as part of a highly integrated design complex in an industrial greenfield setting. While the CAPEX and OPEX cost estimates for the Rectisol® unit are useful for informational purposes, it would be inappropriate for use in benchmarking or direct comparison against other carbon capture technologies with unrelated objectives or in brownfield applications.

CAPEX

The Rectisol® cost estimate prepared in 2012 is shown in Table 6.1.2.

Table 6.1.2 – Rectisol® CAPEX Estimate

Rectisol® Cost Estimate 2012 (\$MM)	
Major Equipment	\$ 58.9
Material	\$ 39.7
Sub-Contracts	\$ 49.2
Labour	\$ 55.3
Engineering	\$ 30.8
Commissioning	\$ 16.4
Owners	\$ 23.7
Contingency	\$ 24.9
Total	\$ 298.7

Canadian Content

The local socio-economic activity from on-site construction of the gasifier unit and off-site module fabrication is expected to be significant. An international firm with significant operations and history in Alberta has been selected to bring integrated engineering, design, procurement, module fabrication, construction and site management services to the project. A forecast of Canadian content for the Rectisol® unit will be prepared as construction planning progresses.

OPEX

The operating cost of the Rectisol[®] unit is provided for informational purposes and should not be used for comparing or benchmarking against other CCS projects.

Table 6.1.3 – Rectisol[®] OPEX Estimate (not for inclusion in carbon capture cost profile)

Categories	\$/tonne CO ₂	Percent
Direct Operating Costs		
- Steam and Electricity ²	5.67	45
- Solvent	0.12	1
Total Direct Costs	5.79	46
Indirect Operating Costs		
- G&A	2.44	20
- Maintenance	2.91	23
- Turnaround	1.04	8
- Water Services	0.35	3
Total Indirect Costs	6.74	54
Total Operating Cost	12.53	100

- 1) Based on forecast avoided emissions of 1,195,306 tonnes/year.
- 2) Assumed cost of electricity is \$60/MWh.

SECTION 6 ECONOMICS – CAPTURE, TRANSPORTATION, STORAGE & CCS VALUE CHAIN		
Section 6.2 Revenues for Capture, Transportation and Storage		
Description:	Provide revenues generated from capture operations, pipeline transport, and storing CO ₂ . The information should include the CCS revenue that each tonne of captured, transported, and injected/stored CO ₂ would generate. Revenue will be presented in terms of industry benchmarks so that confidential commercial information is not divulged. Revenues from base plant operations are not required (<i>e.g.</i> , power plant, upgrader or industry process is not included).	
Purpose:	This information is relevant for understanding the financial drivers in CCS projects. It also informs stakeholders, industry and R&D of the potential incomes of a full CCS project.	
Reporting Requirements:	Quantitative Data/Information	Qualitative Knowledge
Before Operation	Full CCS value chain revenues estimates – based on data from capture, transport and storage. The revenues presented should include, but not limited to: <ul style="list-style-type: none"> - revenues from CO₂ sold (EOR projects or other purposes) - pipeline tariffs or tolls - Any credits, allowances, offsets or other consideration made based upon the achievement of reductions in greenhouse gas emissions to the atmosphere. - Any other revenue generated through the activities of the Project. 	Rationales for the financial estimates of the capture facility Lessons learned

No industry benchmarks are available at this time, as the CCS industry is still in its preliminary stages, therefore revenue cannot be presented in terms of industry benchmarks.