

8. ACCS GROUPS: Flowcharts, Diagnoses and Interventions

Effective April 2008

Ambulatory Care Classification Documentation

ACCS GROUPS: Flowcharts, Diagnoses and Interventions

In this section of the documentation, flowcharts and tables are presented for each of the ACCS intervention and clinical groups. The tables identify ICD-10-CA diagnosis and CCI intervention codes that group to each of the ACCS cells.

The diagnosis and intervention tables are available as downloadable self-extracting files in Excel and Access format. To download the tables, go to <http://www.health.gov.ab.ca/>. Under [News/Media/Resources](#) select [Publications](#). Next go to [Ambulatory Care](#) and [Alberta Ambulatory Care Reporting Manual 2008](#).

ACCS Cell #	Intervention Group
1.1 – 1.4	Nerve and Other
2	Spinal
3	Nerve Injection
4	Orbital & Other Eye
5	Lens Interventions
6	Iris & Other Eye
7	Strabismus
8	External Eye
9	Bronch/Pharynx
10	Tympanoplasty
11	Sinus Interventions
12	Other Sinus
13 - 13.2	Tonsils and Adenoids
14	Nasal Interventions
15	Other Respiratory
16 - 16.4	External Ear
17	Respiratory Endoscopy - ENT
18	Pacemaker Implant
19 - 19.2	Cardiac Catheter
20 - 20.3	Angiography
21 - 21.1	Vascular Interventions
22	Other Vascular Interventions
23.1 - 23.4	Lymphatic Interventions
24	Minor Vascular
25	Cholecystectomy
26	Hernia
27	ERCP
28.1	Endoscopy GI - Low
28.2	Endoscopy GI - Medium
28.3	Endoscopy GI - High
29.1 - 29.4	Ano-Rectal Interventions
30.1 - 30.4	Minor Anal Interventions
31	Mechanical Implants
32	Lithotripsy

ACCS Cell #	Intervention Group
33	Upper Urinary Interventions
34.1	Lower Urinary & Genital
34.2	Reconstruction, Vas Deferens
35.1 - 35.4	Bladder & Urethral Interventions
36.1	Vasectomy
36.2	Other Male Genital Interventions
37 - 37.4	Circumcision
38	Uro Diagnostic Interventions
39	Uterus & Adnexal Interventions
40	Endo & Gyn Interventions
41	Minor Gyn Interventions
42	Evacuations
43	Maxillo-Facial
44	Other Bone Interventions
45.1	Upper Extremity Interventions
45.2	Shoulder Interventions
46	Open Reductions
47	Tendon & Muscle Interventions
48	Closed Reductions
49	Lower Extremity
50	Knee Interventions
51	Hand, Ankle & Foot
52.1	Remove Int Fixations, Lower Extremity
52.2	Other Removal, Int Fixation
53	Soft Tissue Interventions
54	Manipulations
55	Mastectomy
56.1	Augment/Reduc Breast Bilateral
56.2	Augment/Reduc Breast Unilateral
57	Breast Plastic Interventions
58.1	Ear & Cleft Lip Reconstruction
58.2	Face Rhytidectomy
58.3	Other Plastic Reconstruction
59.1 – 59.4	Skin Interventions
60	Dental Surgery
61.1	Biopsy, Other
61.2	Biopsy, Percutaneous
62	Hemodialysis
62.1	Home Hemodialysis Teaching
62.2	Selfcare Hemodialysis
63	Transfusions
64	Cardioversion
65	Chemotherapy - Oncology
66	Myelogram
68	Thyroid Interventions
69	Parotid Duct Interventions
70	Appendectomy
71	Gastro-Intestinal Related Interventions
72	Peritoneal Dialysis
72.1	Home Peritoneal Dialysis Teaching
73	Hos Visit Including Diagnostic Investigation of Vascular Sys

ACCS Cell #	Intervention Group
74	Hospital Visit Including Nuclear Imaging
75	Hospital Visit Including CAT Scan
76	Hospital Visit Including MRI
77	Hospital Visit Including Radiotherapy
78	Discrete Chest Xray
79	Discrete Other Xray
80	Discrete Mammogram
81	Discrete Ultrasound
82.1	Extensive Sleep Studies
82.2	Other Sleep Labs
83	Inner Ear
84	Hyperbaric Chamber
85	Discrete Diagnostic Investigation of Vascular System
86	Discrete Nuclear Imaging
87	Discrete CAT Scan
88	Discrete MRI
89	Discrete Radiotherapy
99	Ungroupables - Based on Interventions
201 - 220	Cardiac
251 - 267	Endocrine
301 - 306	Ears, Nose, Throat (ENT)
351 - 364	Genitourinary
400 - 413	Gastrointestinal
451 - 456	Hematology
501 - 502	Hepatobiliary
551 - 569	Musculoskeletal
601 - 617	Neurology
651 - 665	Obstetrics/Newborn
701 - 703	Oncology
704	IV Therapy
751 - 758	Ophthalmology
801 - 803	Psychiatry
851 - 864	Respiratory
901 - 906	Skin & Soft Tissue
951 - 957	Systemic Infection
999	Ungroupables
1001 - 1035	Trauma
1051 - 1078	Mental Health
1101 - 1156	Rehabilitation
1201 - 1206	Clinical Nutrition
1221 - 1226	Social Work
1241 - 1249	Psychology (Rehabilitation)
2001 - 2004	Admitted Service Recipient
2021 - 2023	Deceased Service Recipient
2041 - 2042	Transferred Service Recipient
2050 - 2071	Exam/Other
2072-2073	Genetics (Province Wide Services)
2081	Non-Registered Service Recipient
2082	Mode of Service - Telephone
2099	Service Recipient Left Without Being Seen

ACCS

Groups

Intervention

Cells Tab

ACCS Intervention Cell

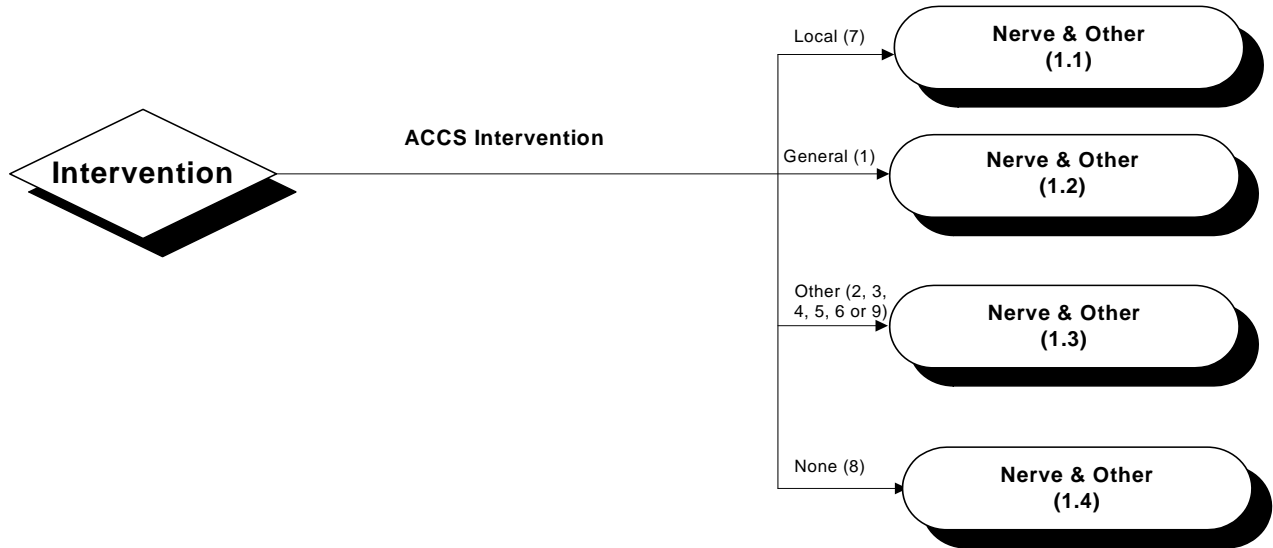

ACCS Grouper
04/00

ACCS Intervention Cell

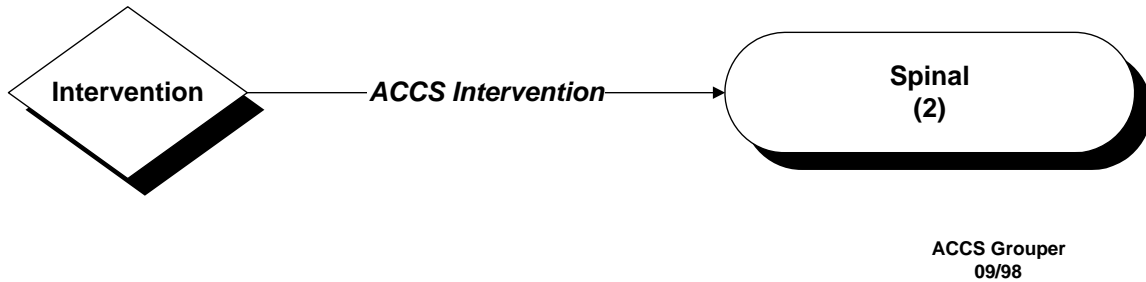

ACCS Intervention Cell

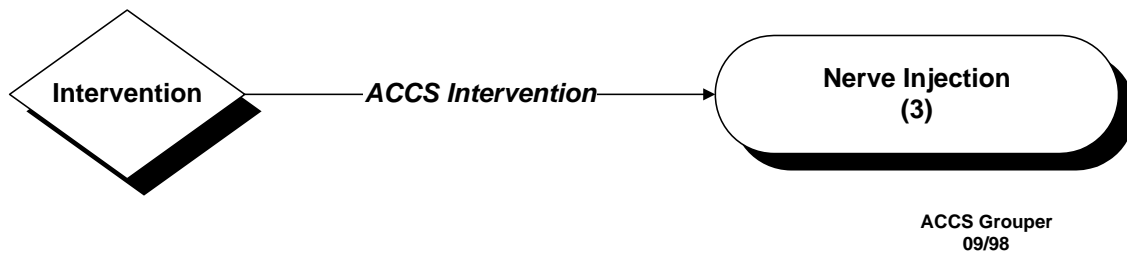

ACCS Intervention Cell

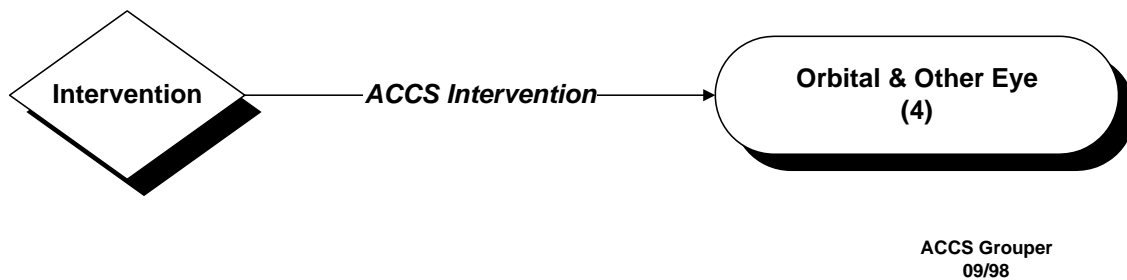

ACCS Intervention Cell

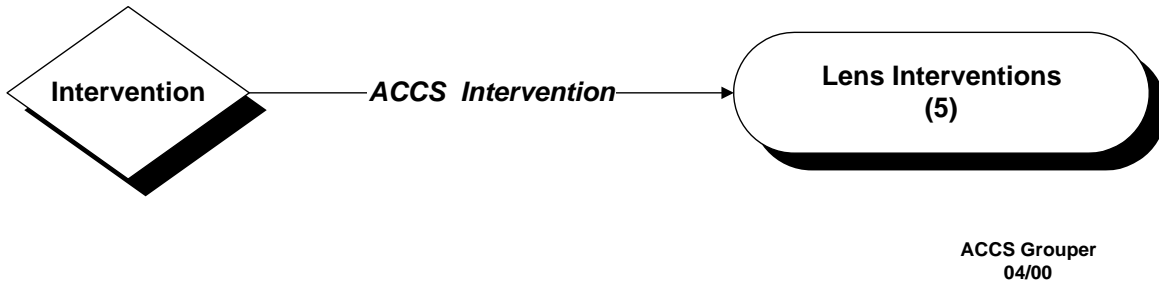

ACCS Intervention Cell

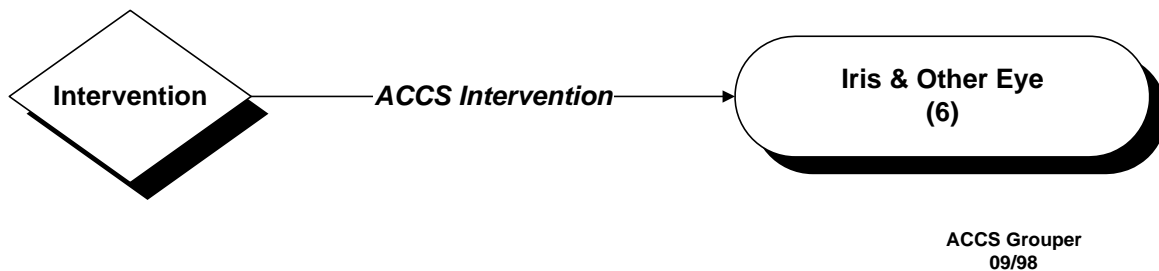

ACCS Intervention Cell

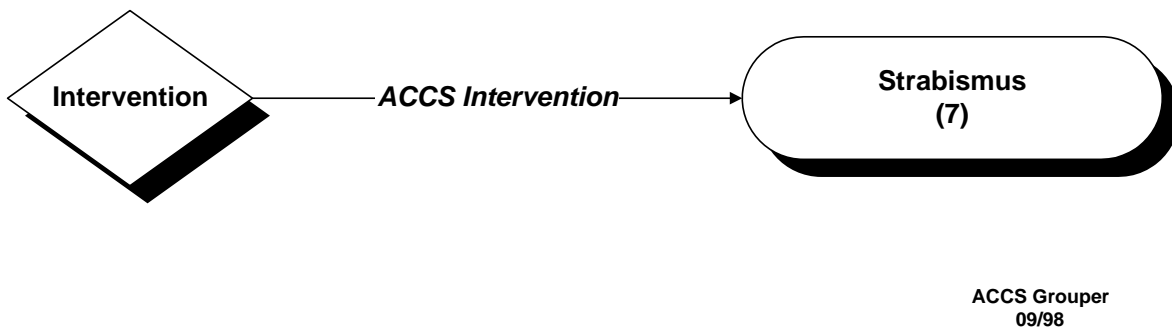

ACCS Intervention Cell

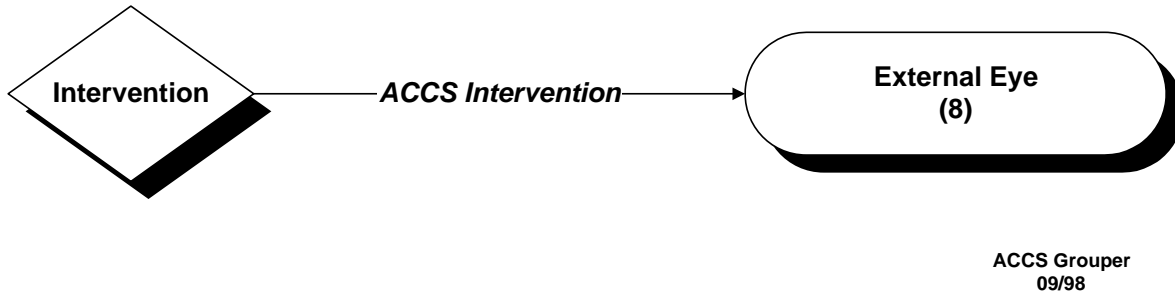

ACCS Intervention Cell

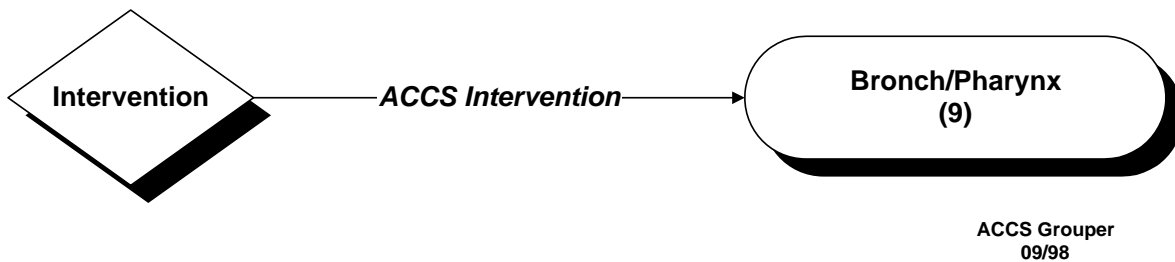

ACCS Intervention Cell

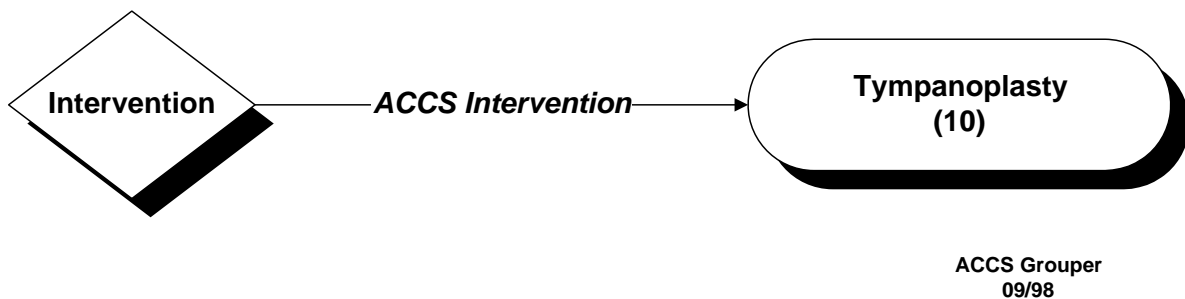

ACCS Intervention Cell

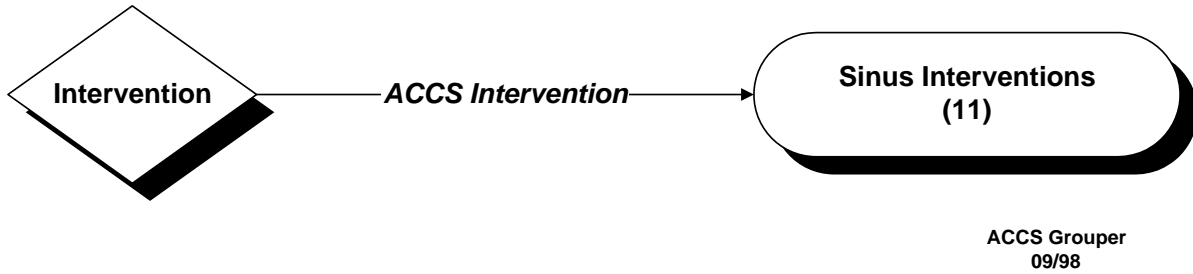

ACCS Intervention Cell

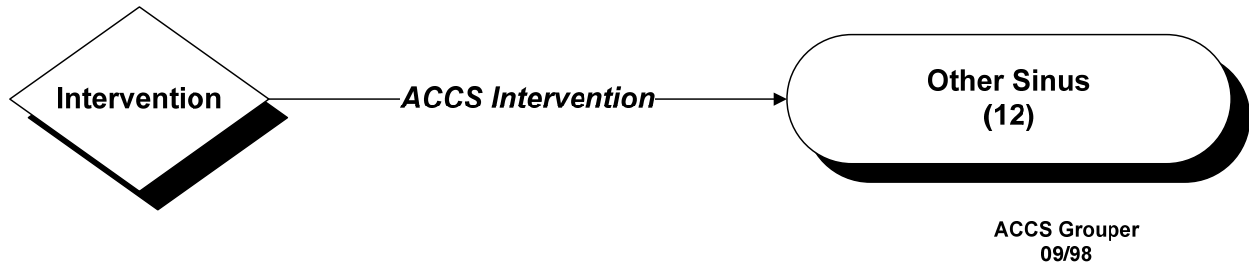

ACCS Intervention Cell

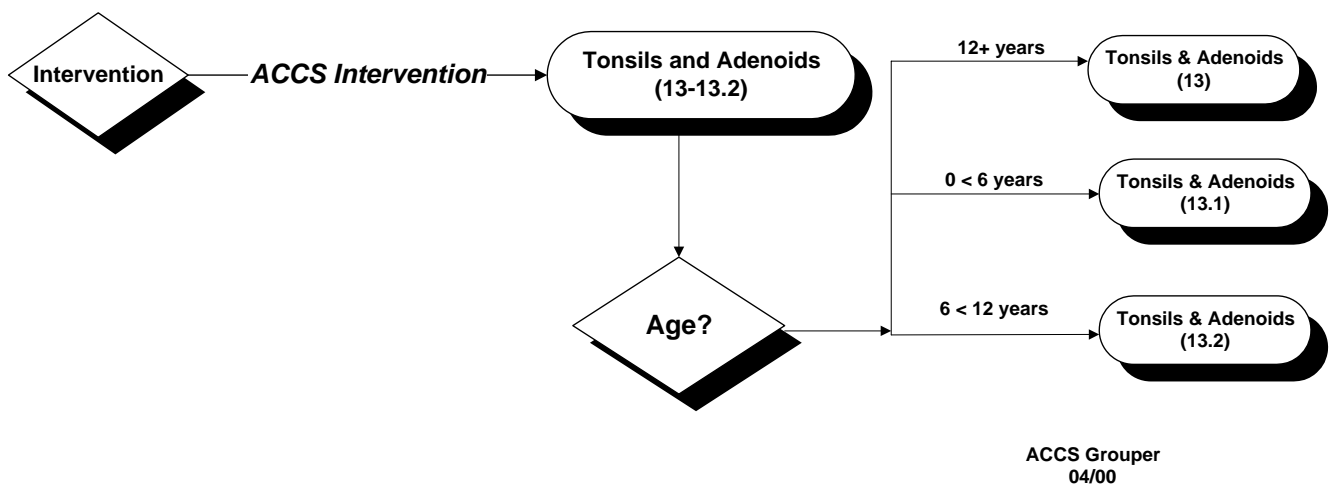

ACCS Intervention Cell

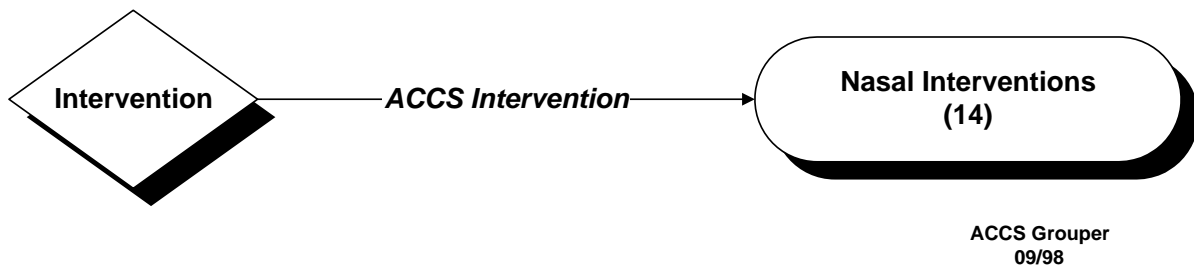

ACCS Intervention Cell

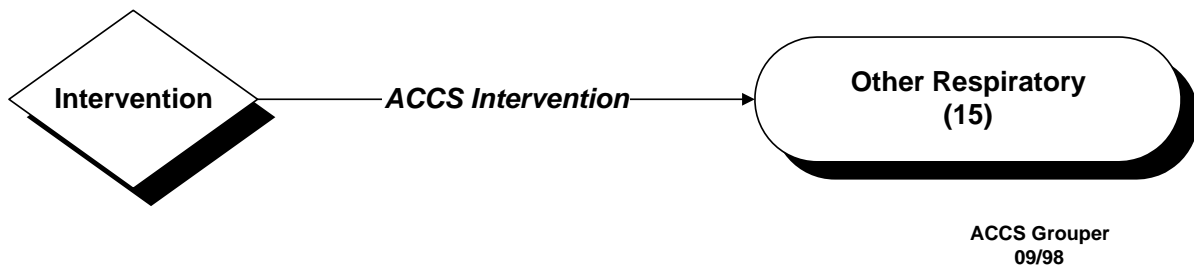

ACCS Intervention Cell

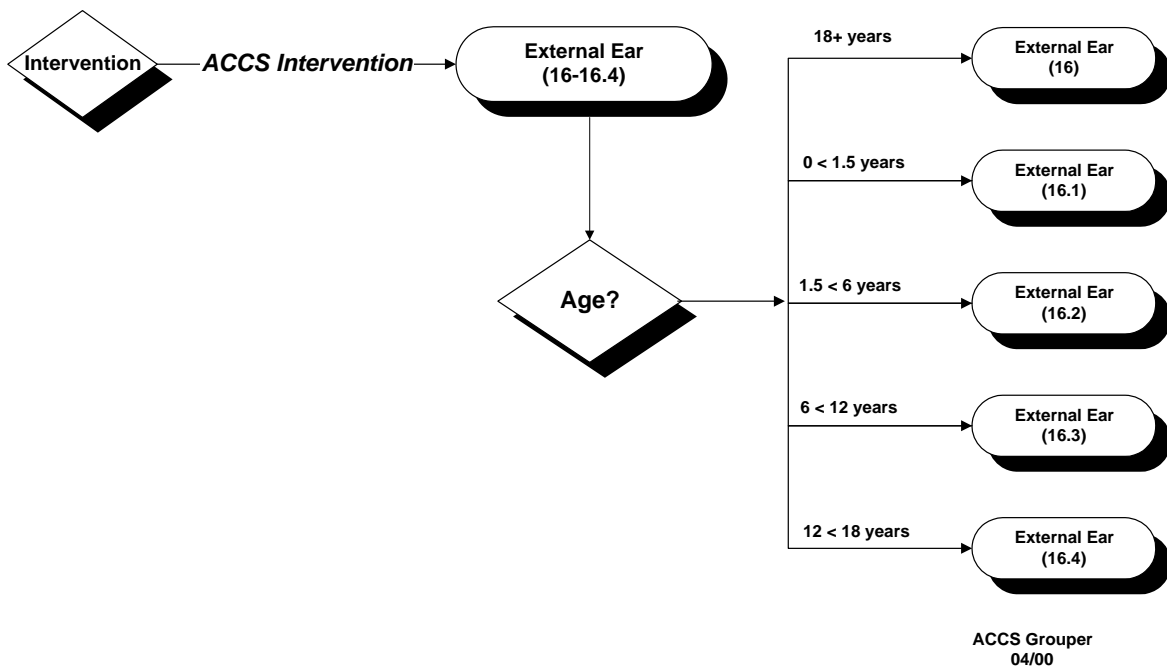

ACCS Intervention Cell

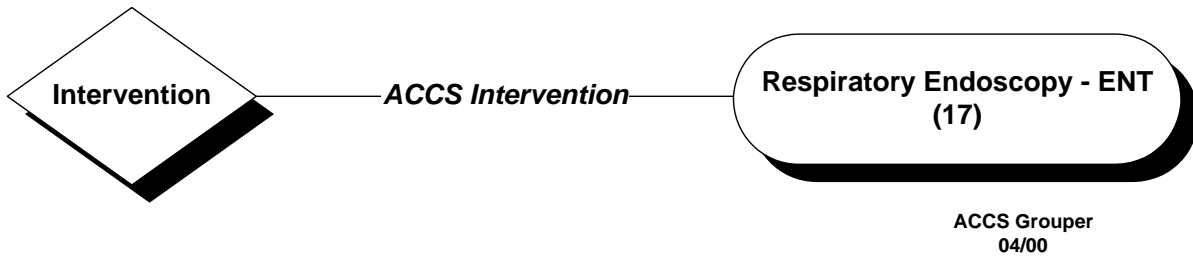

ACCS Intervention Cell

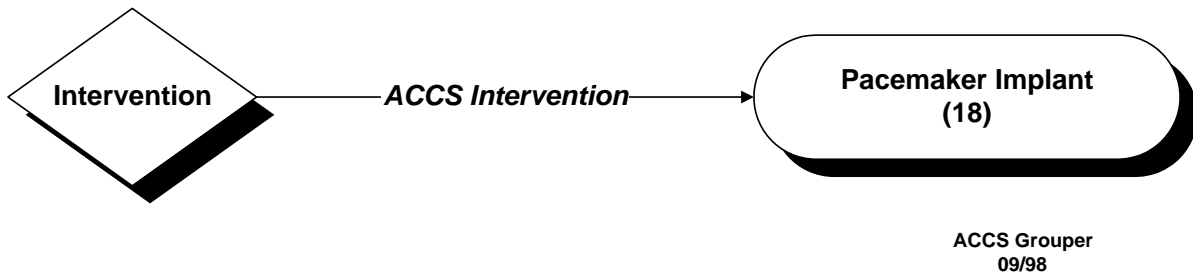

ACCS Intervention Cell

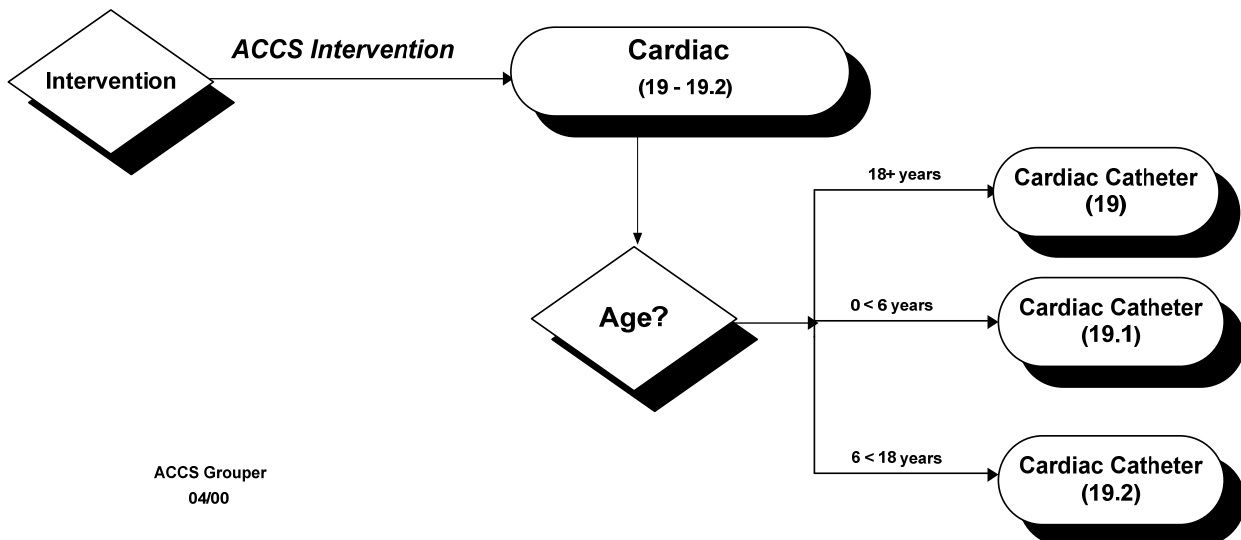

ACCS Intervention Cell

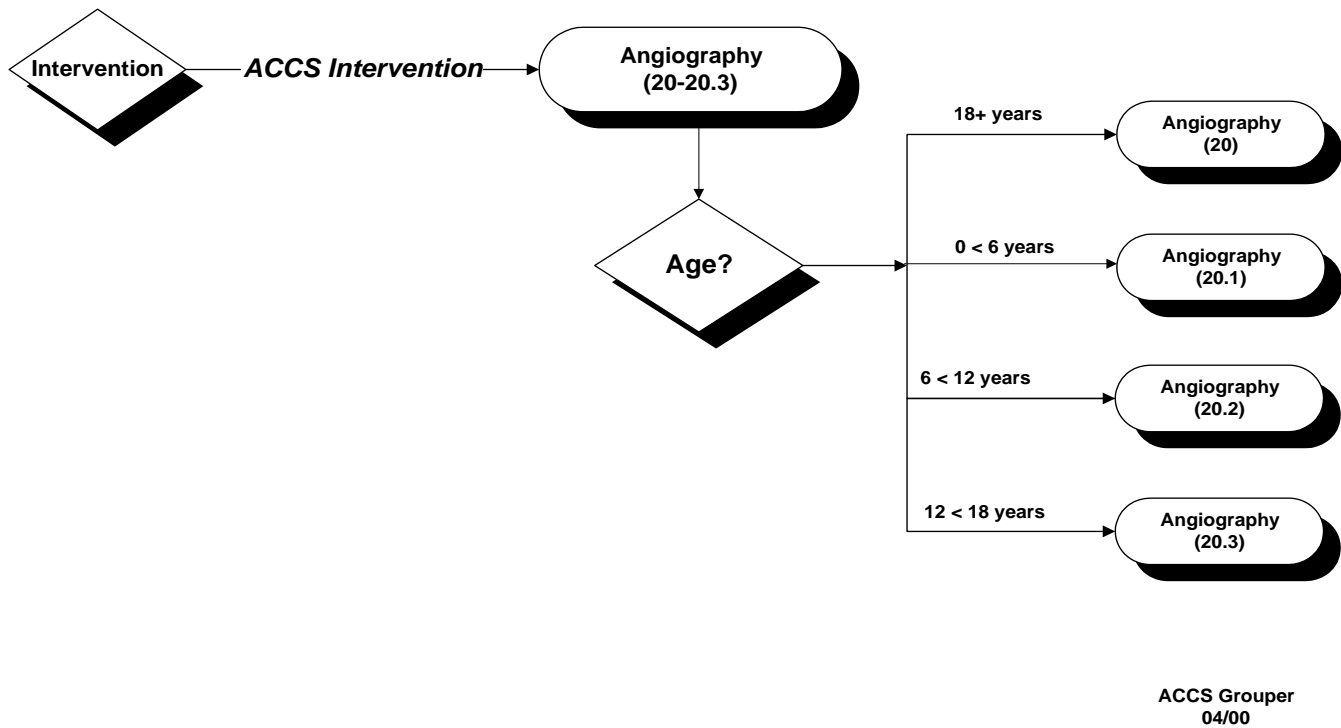

ACCS Intervention Cell

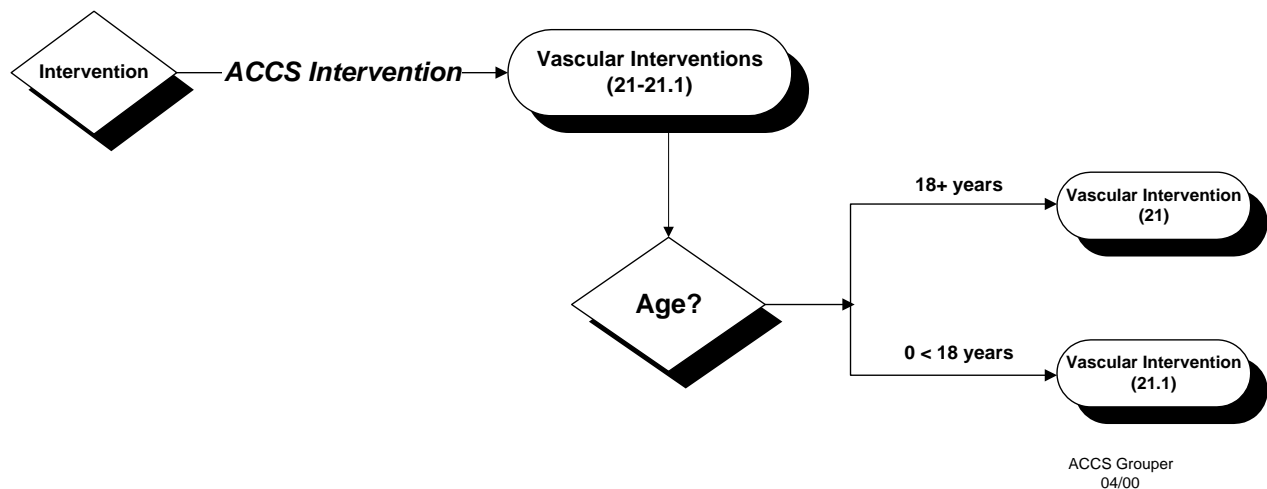

ACCS Intervention Cell

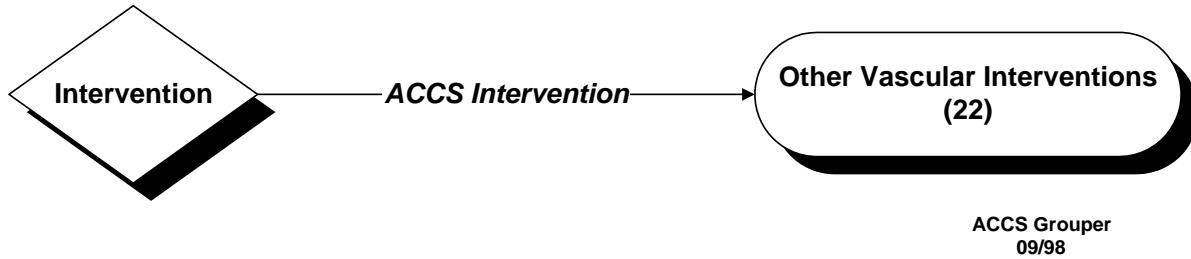

ACCS Intervention Cell

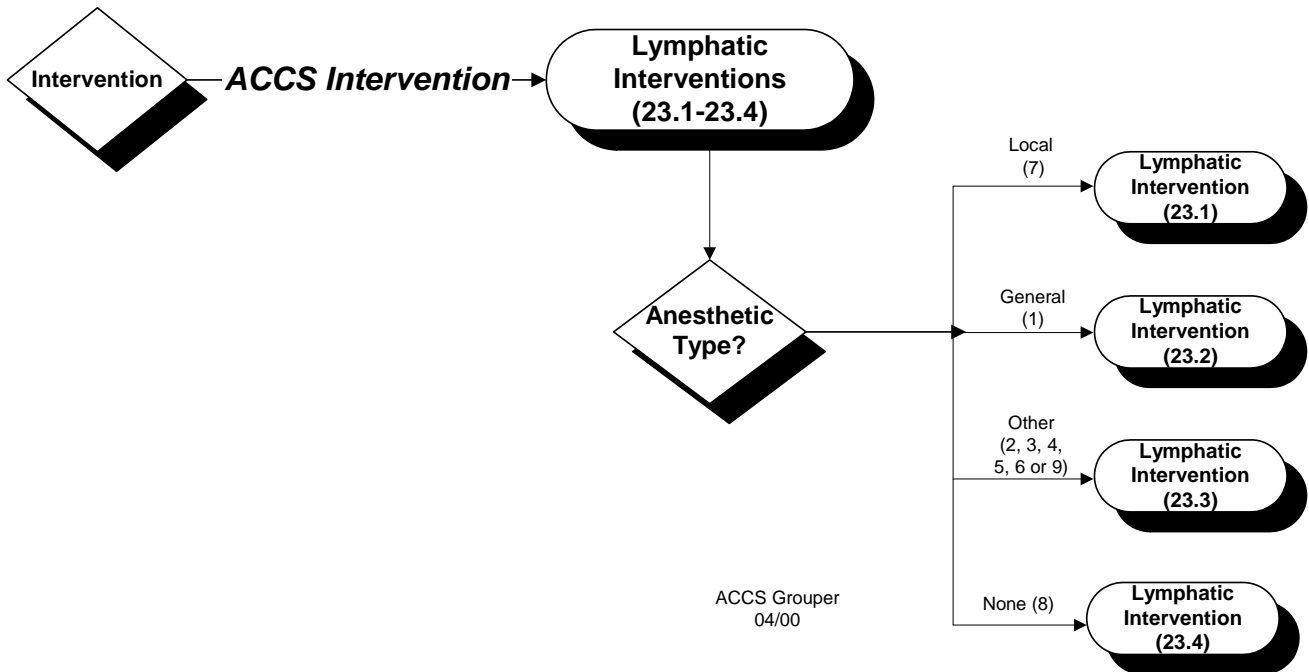

ACCS Intervention Cell



ACCS Intervention Cell



ACCS Intervention Cell



ACCS Intervention Cell



ACCS Intervention Cell

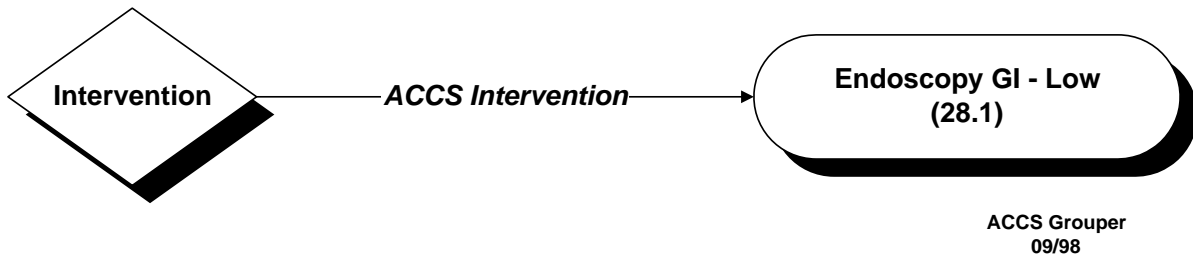

ACCS Intervention Cell



ACCS Intervention Cell

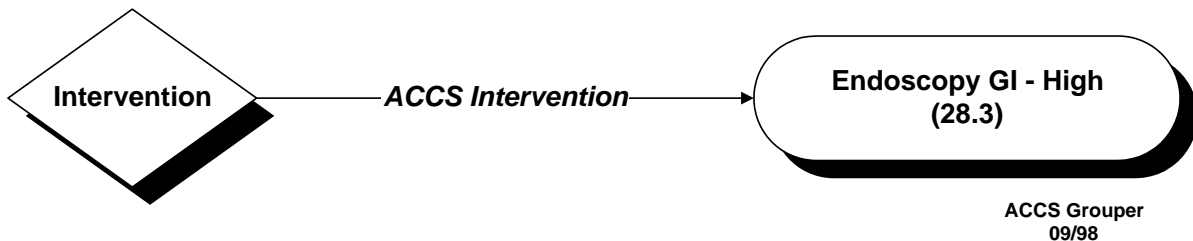

ACCS Intervention Cell

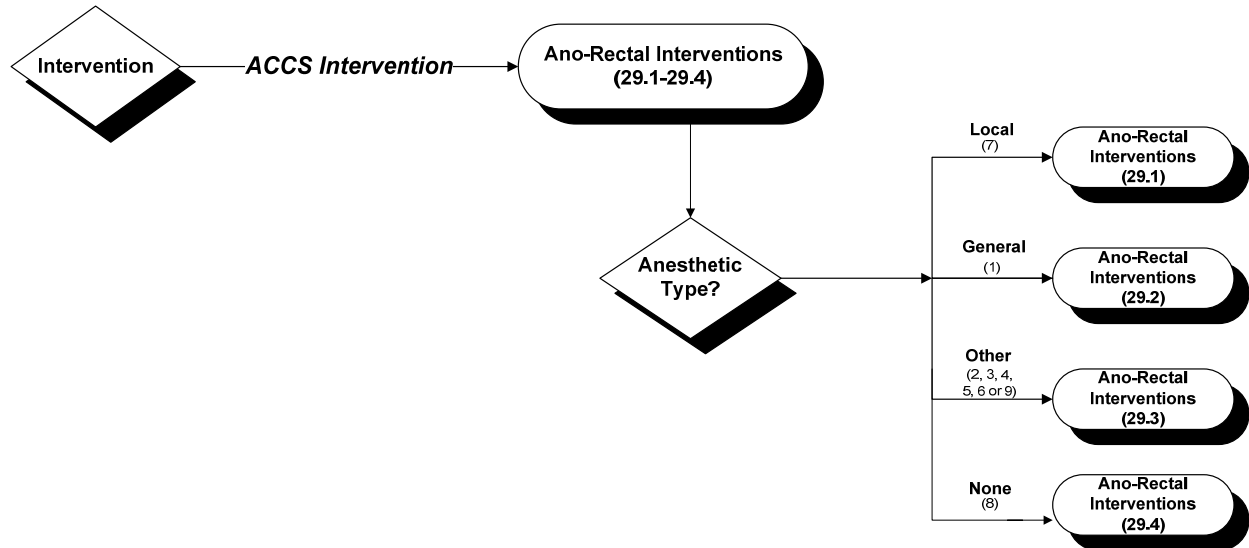

ACCS Groupers
04/00

ACCS Intervention Cell

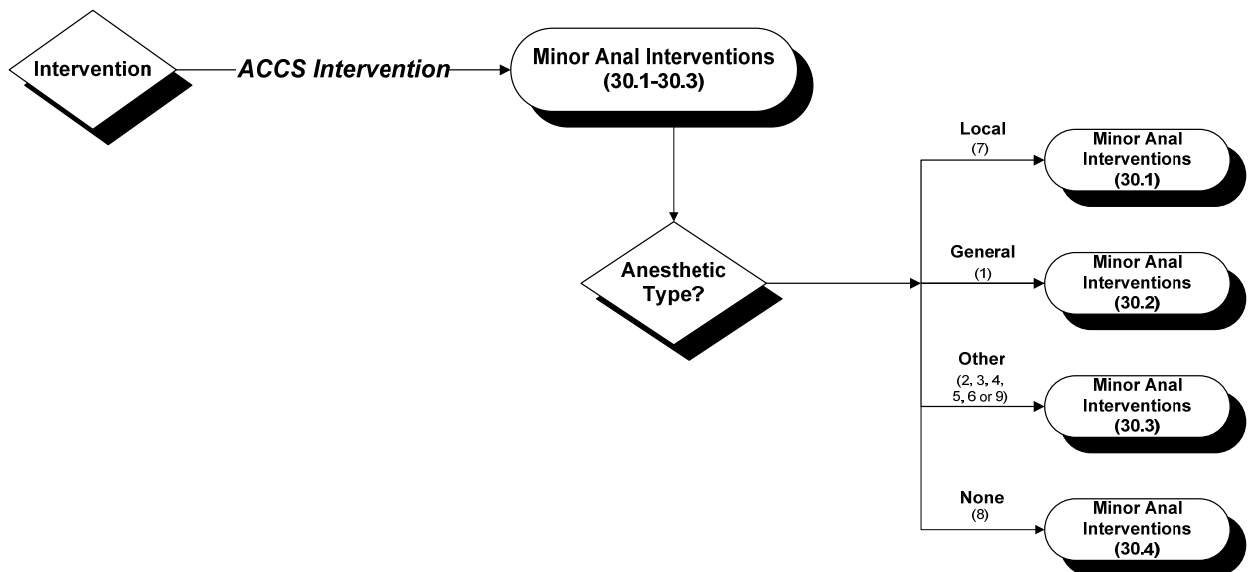

ACCS Groupers
04/00

ACCS Intervention Cell



ACCS Intervention Cell



ACCS Intervention Cell

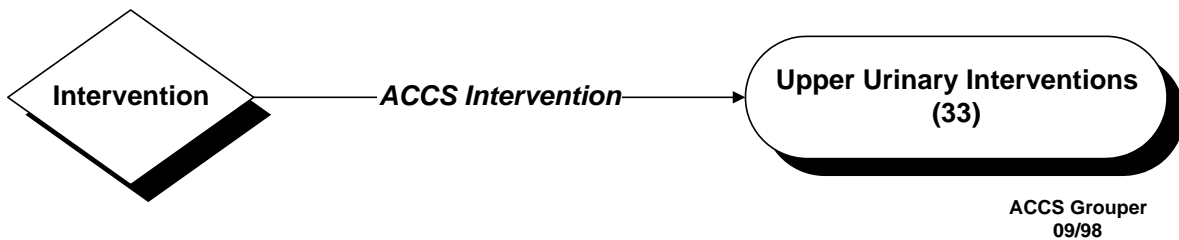

ACCS Intervention Cell

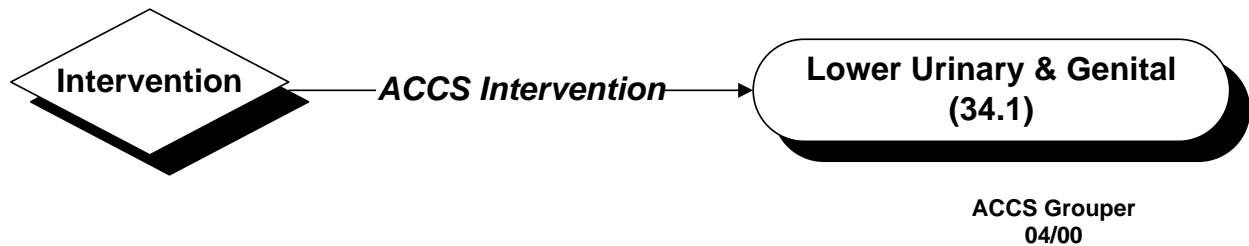

ACCS Intervention Cell

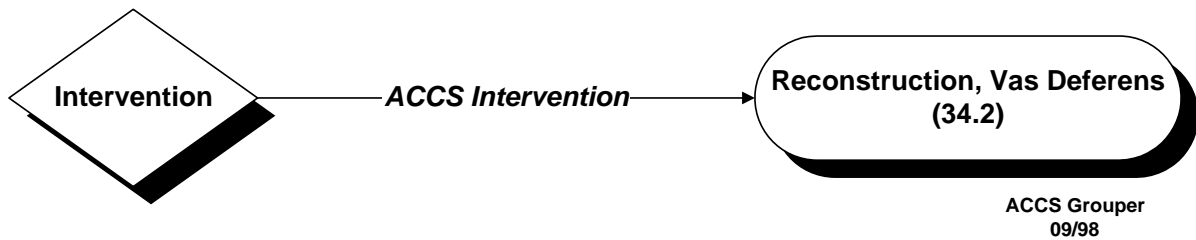

ACCS Intervention Cell

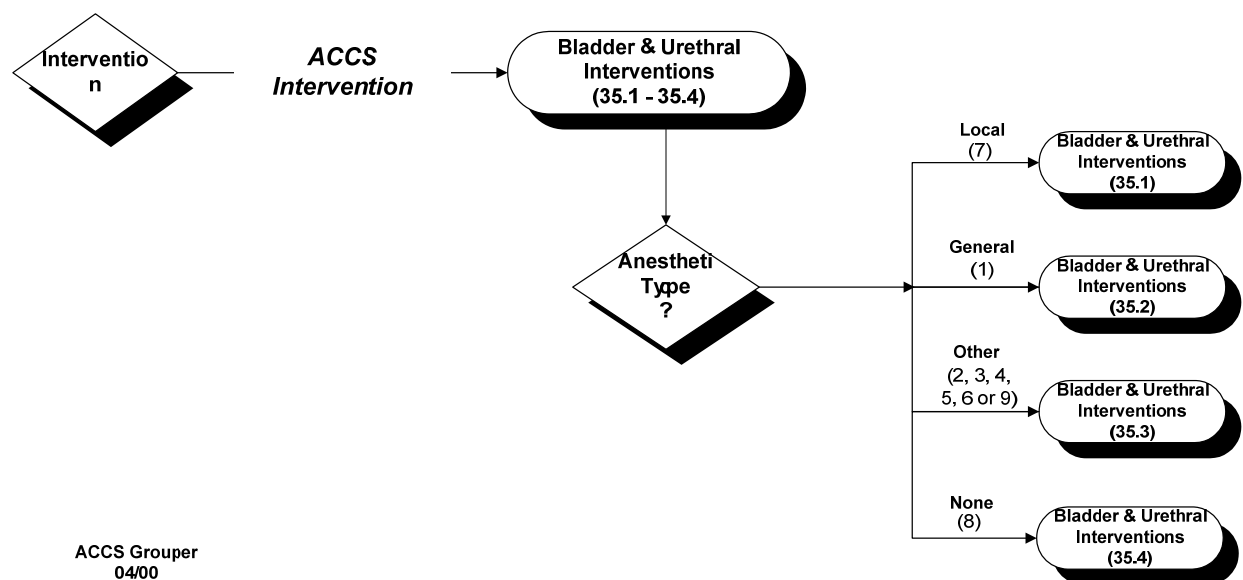

ACCS Intervention Cell

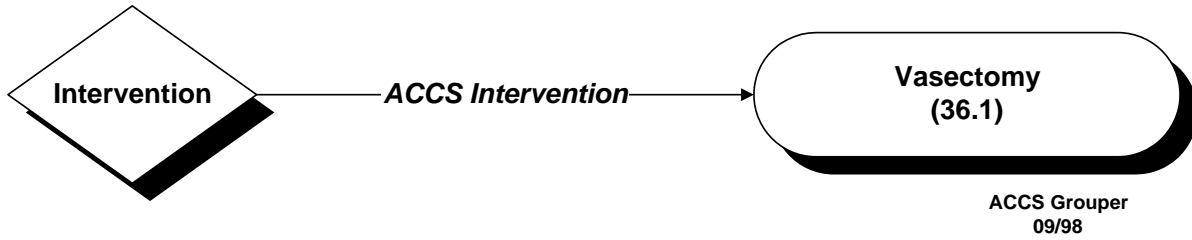

ACCS Intervention Cell



ACCS Intervention Cell

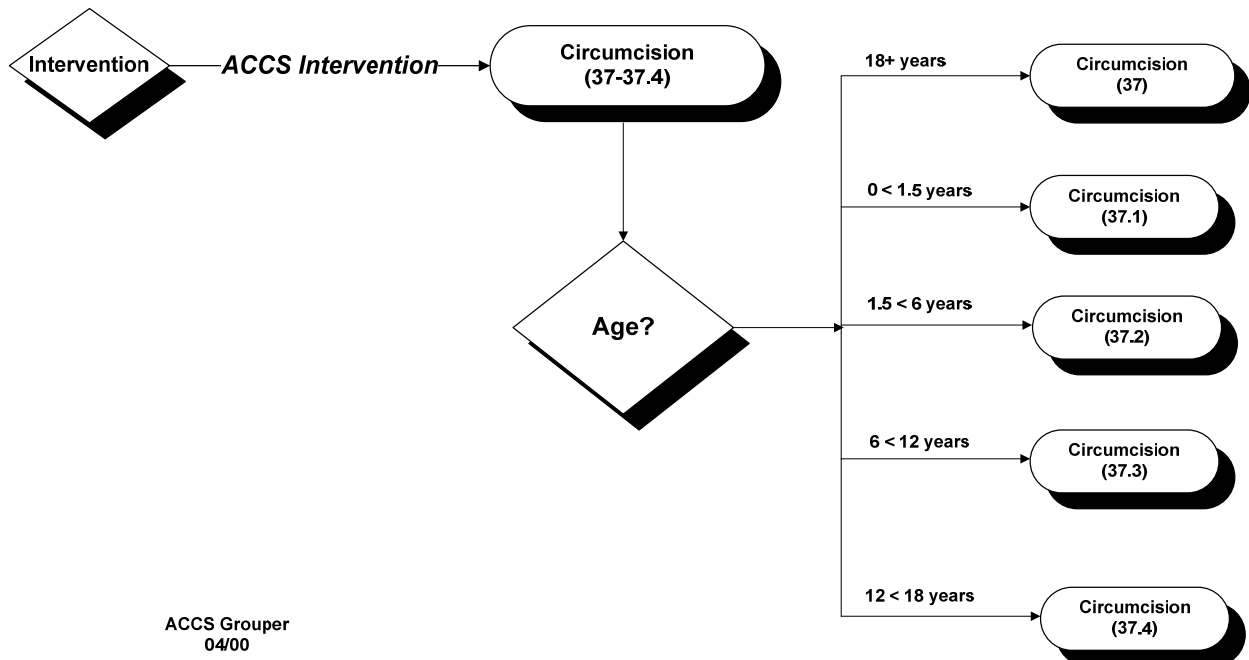

ACCS Intervention Cell



ACCS Intervention Cell

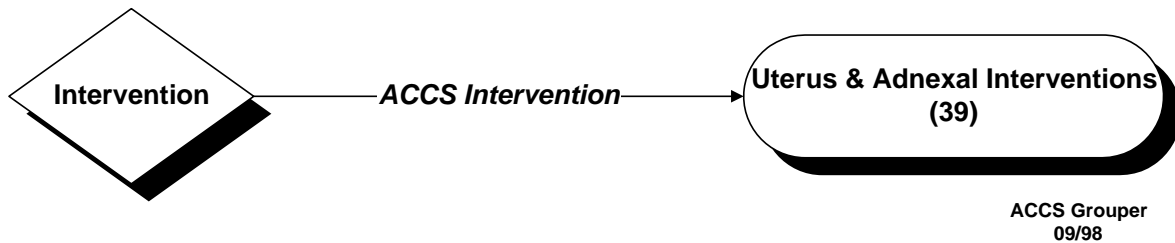

ACCS Intervention Cell

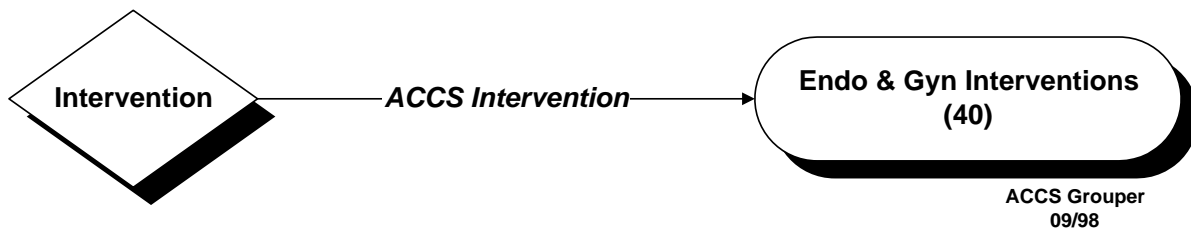

ACCS Intervention Cell

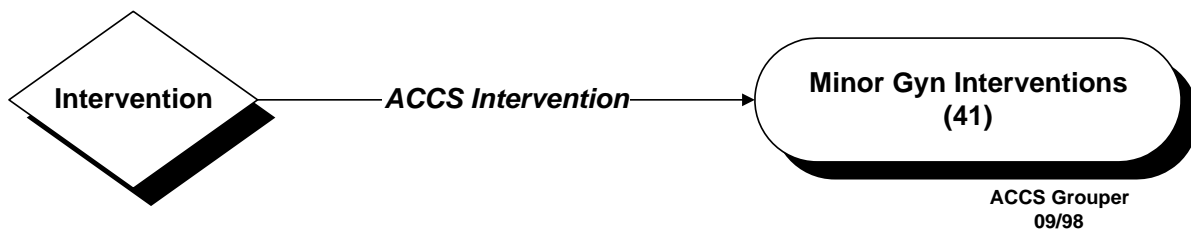

ACCS Intervention Cell



ACCS Intervention Cell

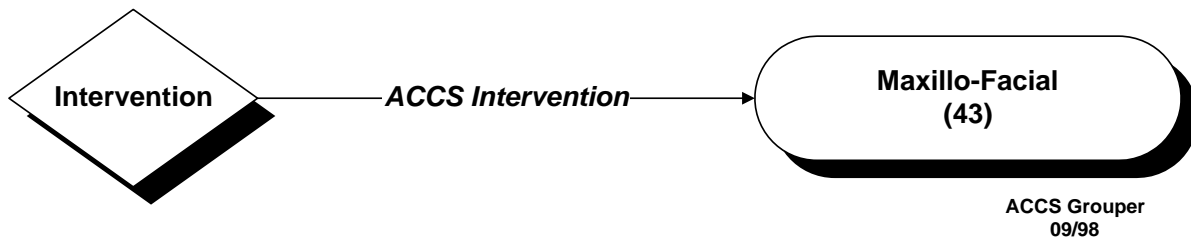

ACCS Intervention Cell



ACCS Intervention Cell



ACCS Intervention Cell

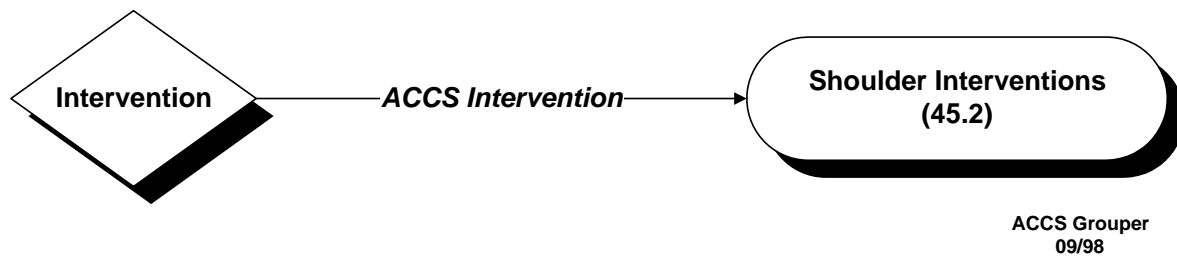

ACCS Intervention Cell

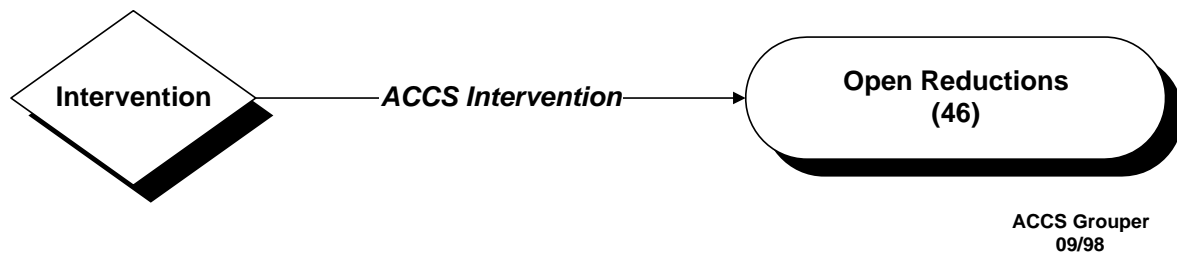

ACCS Intervention Cell



ACCS Intervention Cell

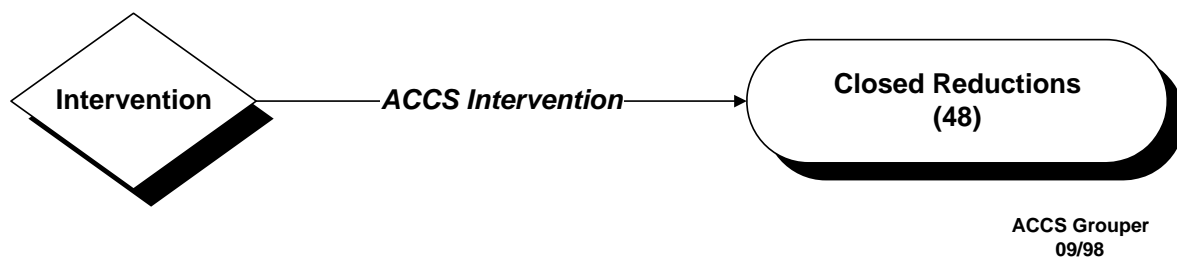

ACCS Intervention Cell



ACCS Intervention Cell



ACCS Intervention Cell

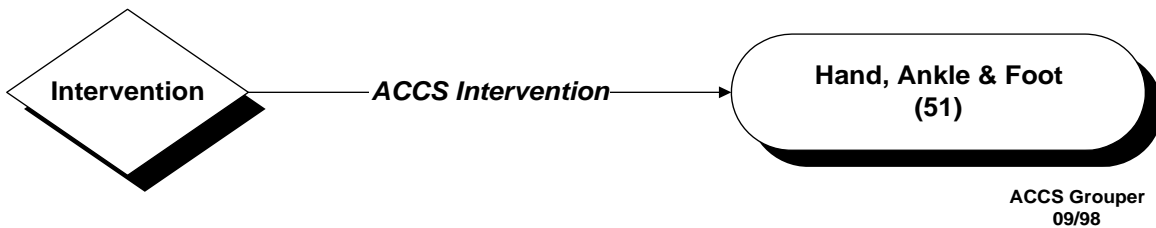

ACCS Intervention Cell



ACCS Intervention Cell

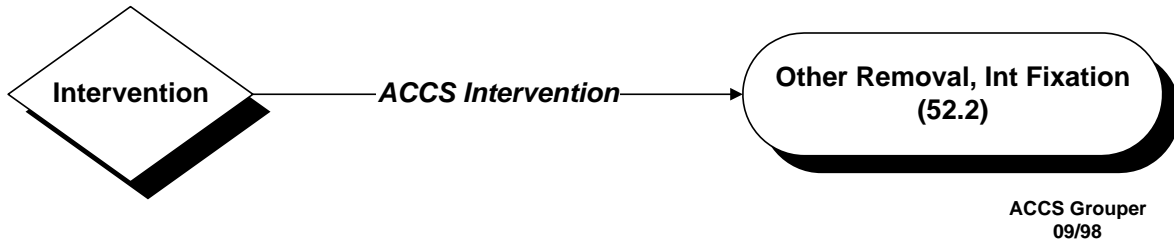

ACCS Intervention Cell

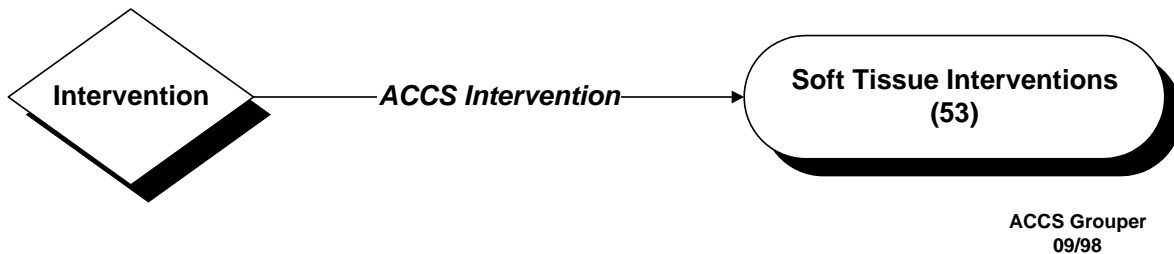

ACCS Intervention Cell

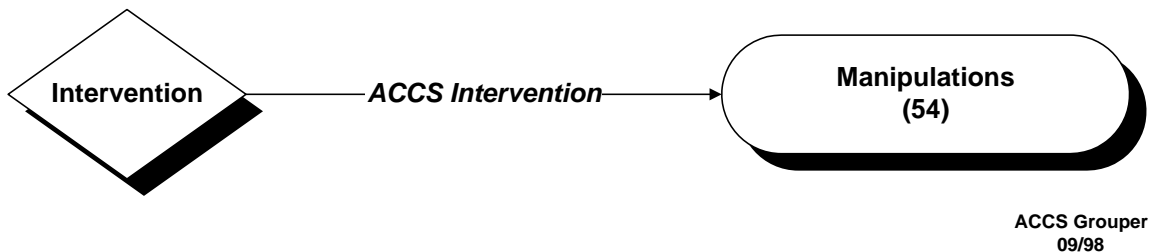

ACCS Intervention Cell

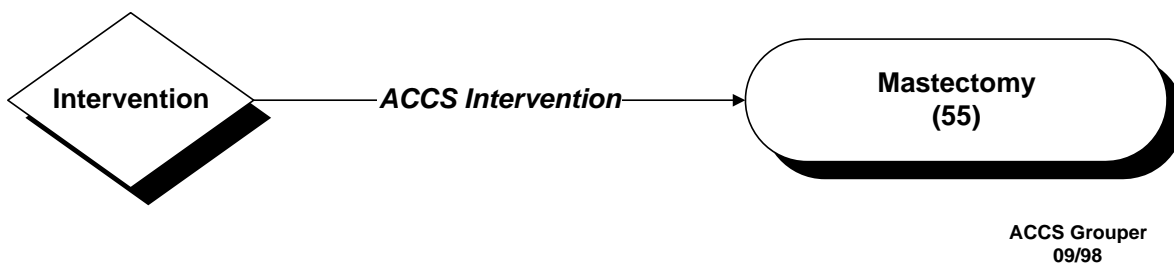

ACCS Intervention Cell



ACCS Intervention Cell

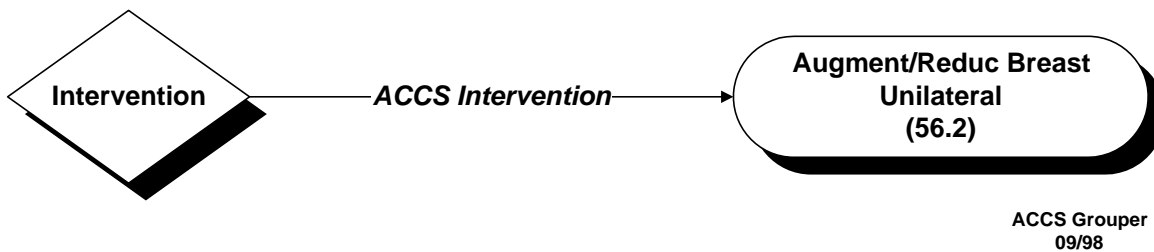

ACCS Intervention Cell

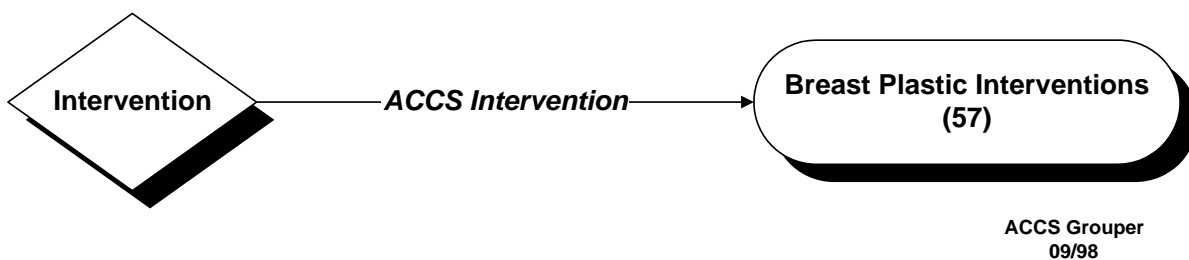

ACCS Intervention Cell

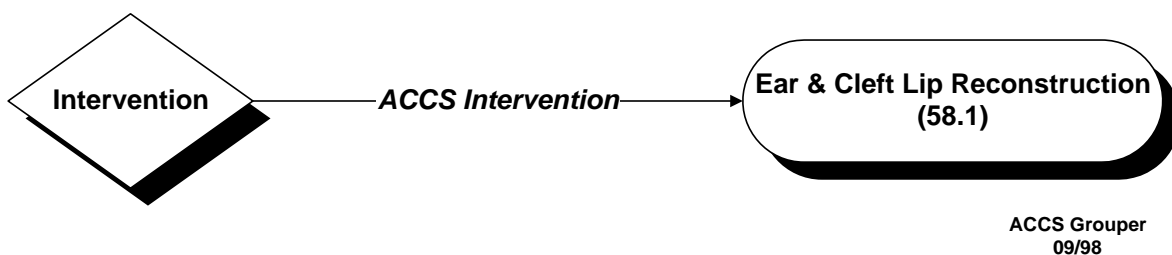

ACCS Intervention Cell

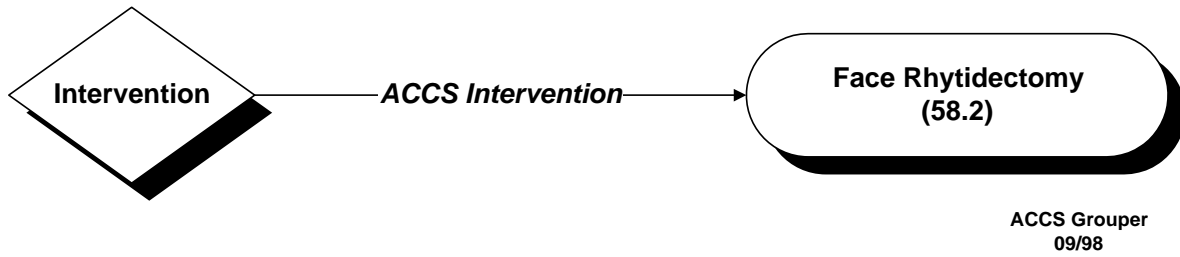

ACCS Intervention Cell



ACCS Intervention Cell

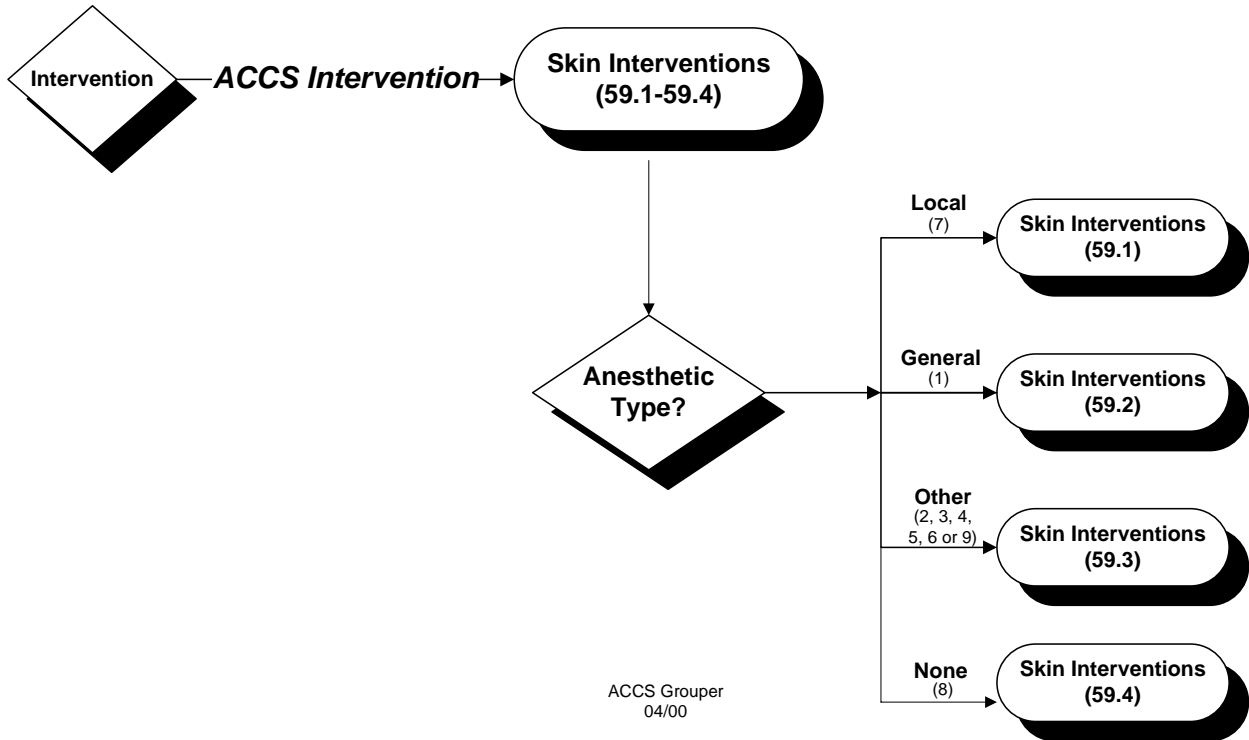

ACCS Intervention Cell



ACCS Intervention Cell

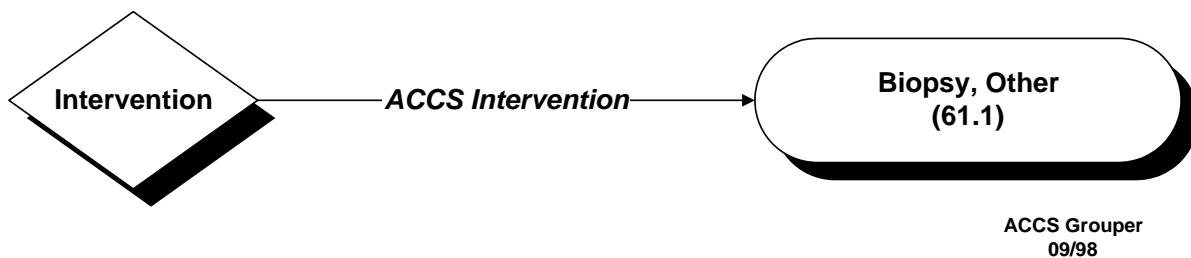

ACCS Intervention Cell



ACCS Intervention Cell

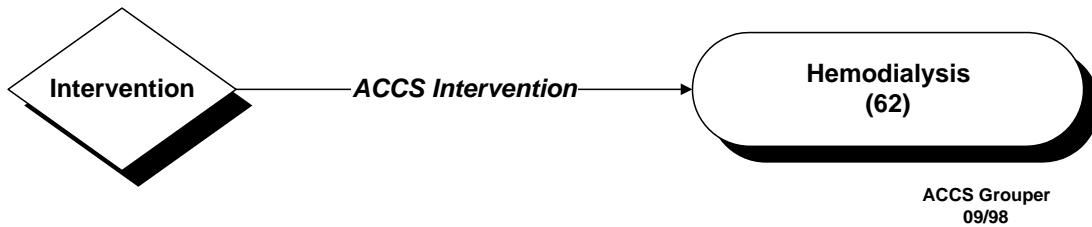

ACCS Intervention Cell



ACCS Intervention Cell

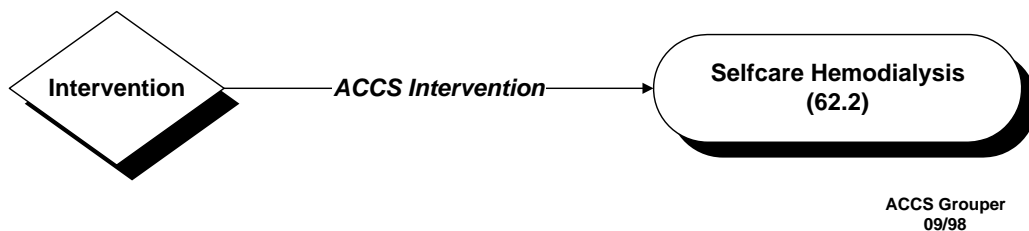

ACCS Intervention Cell

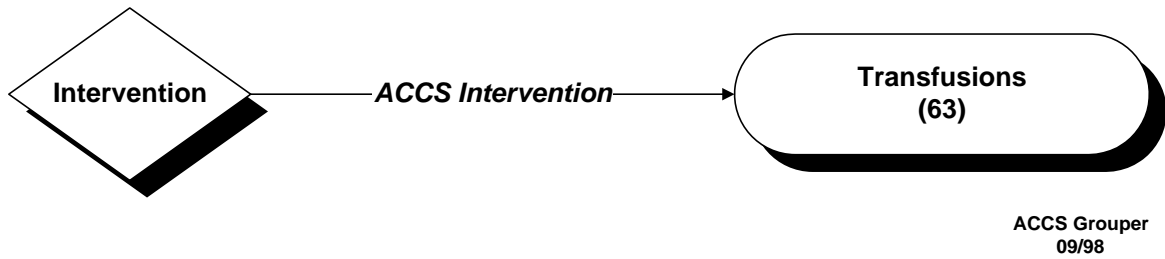

ACCS Intervention Cell

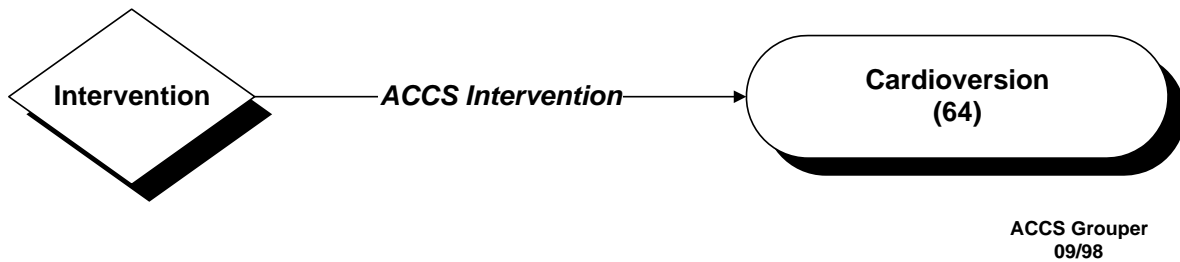

ACCS Intervention Cell



ACCS Intervention Cell



ACCS Intervention Cell



ACCS Intervention Cell

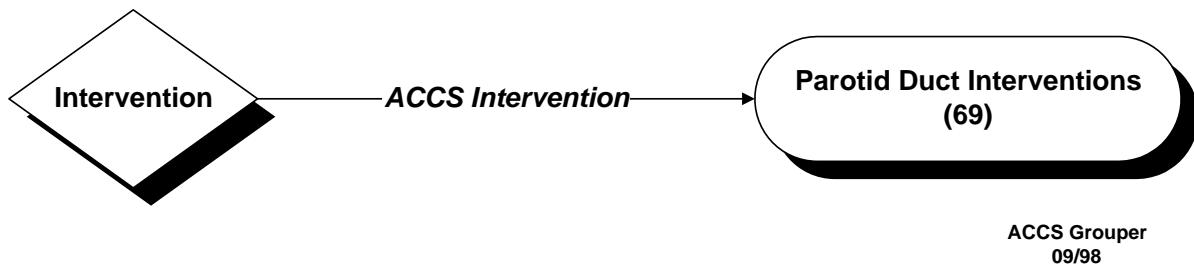

ACCS Intervention Cell



ACCS Intervention Cell



ACCS Intervention Cell

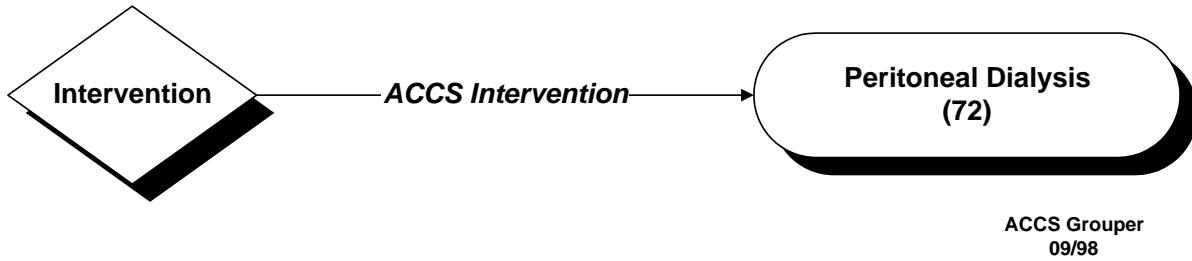

ACCS Intervention Cell



ACCS Intervention Cell



ACCS Intervention Cell



ACCS Intervention Cell



ACCS Intervention Cell



ACCS Intervention Cell



ACCS Intervention Cell

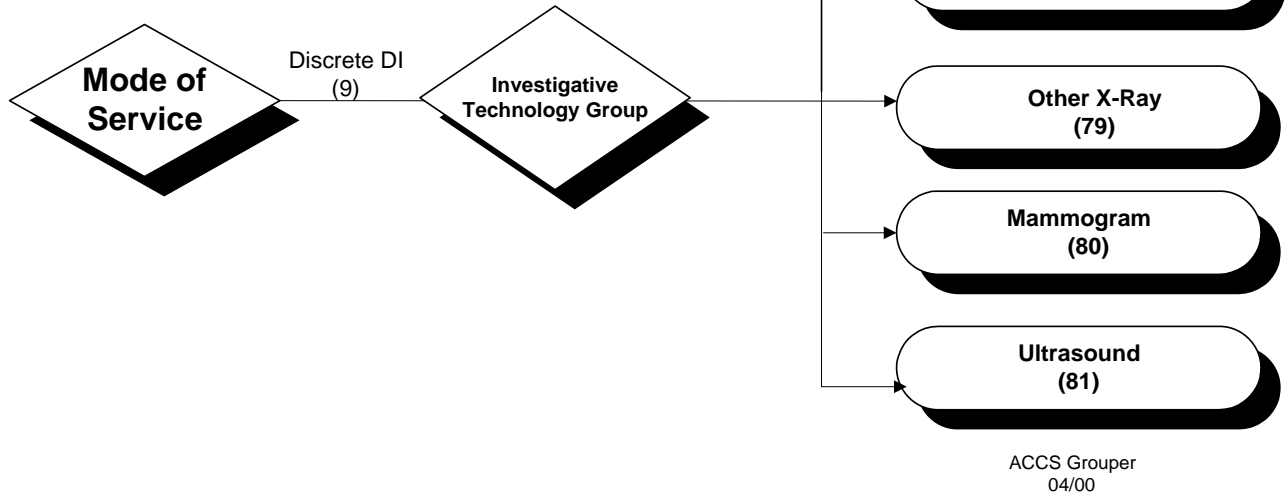

ACCS Intervention Cell

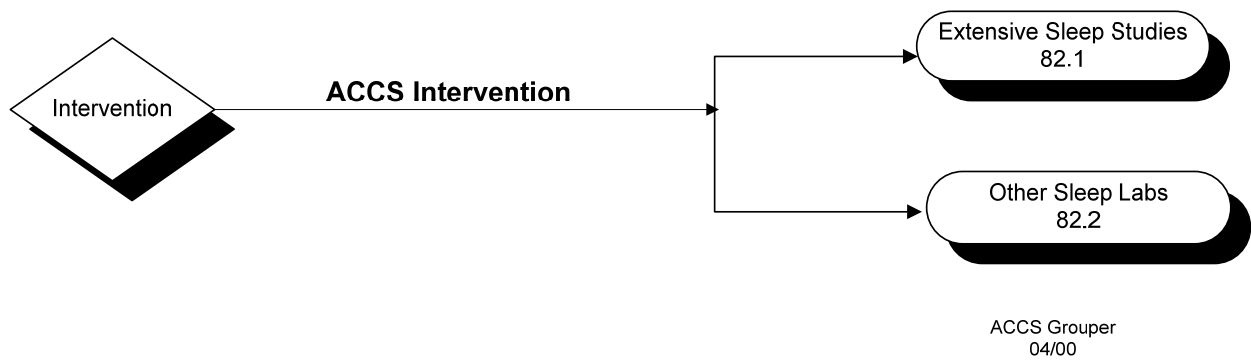

ACCS Intervention Cell



ACCS Intervention Cell



ACCS Intervention Cell

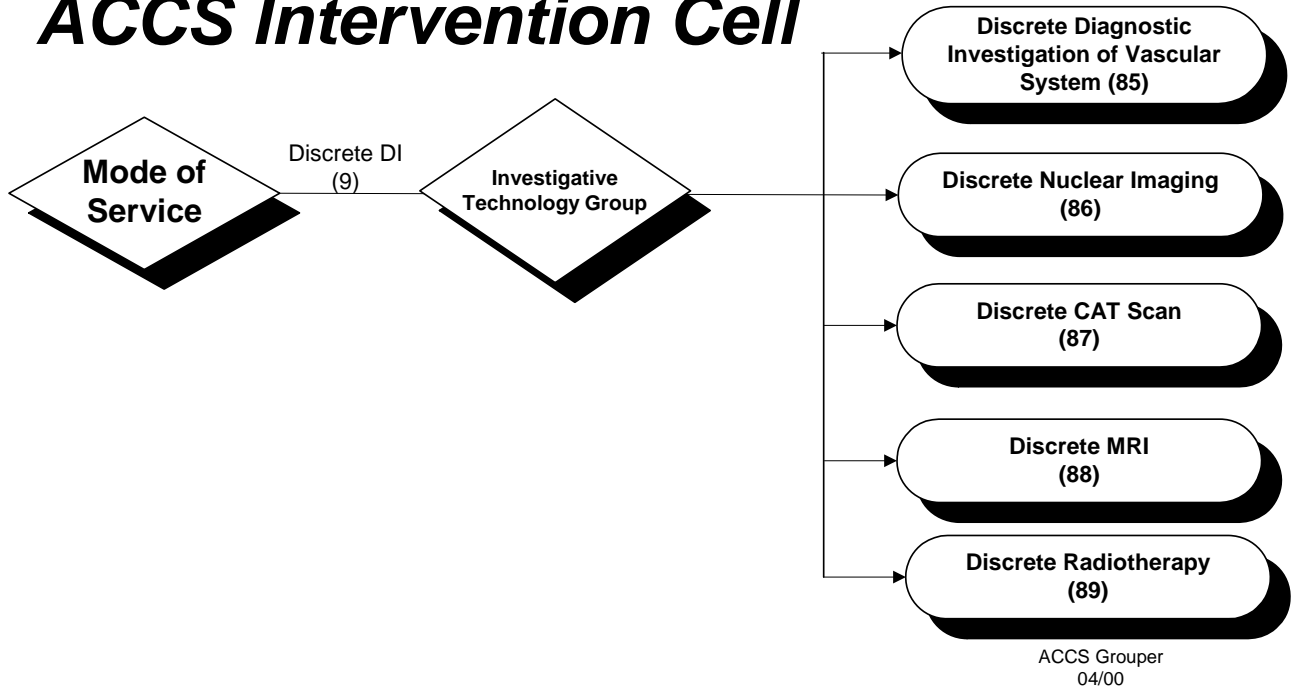

ACCS Intervention Cell



ACCS
Clinical Cells
Tab

Cardiac Clinical Grouping

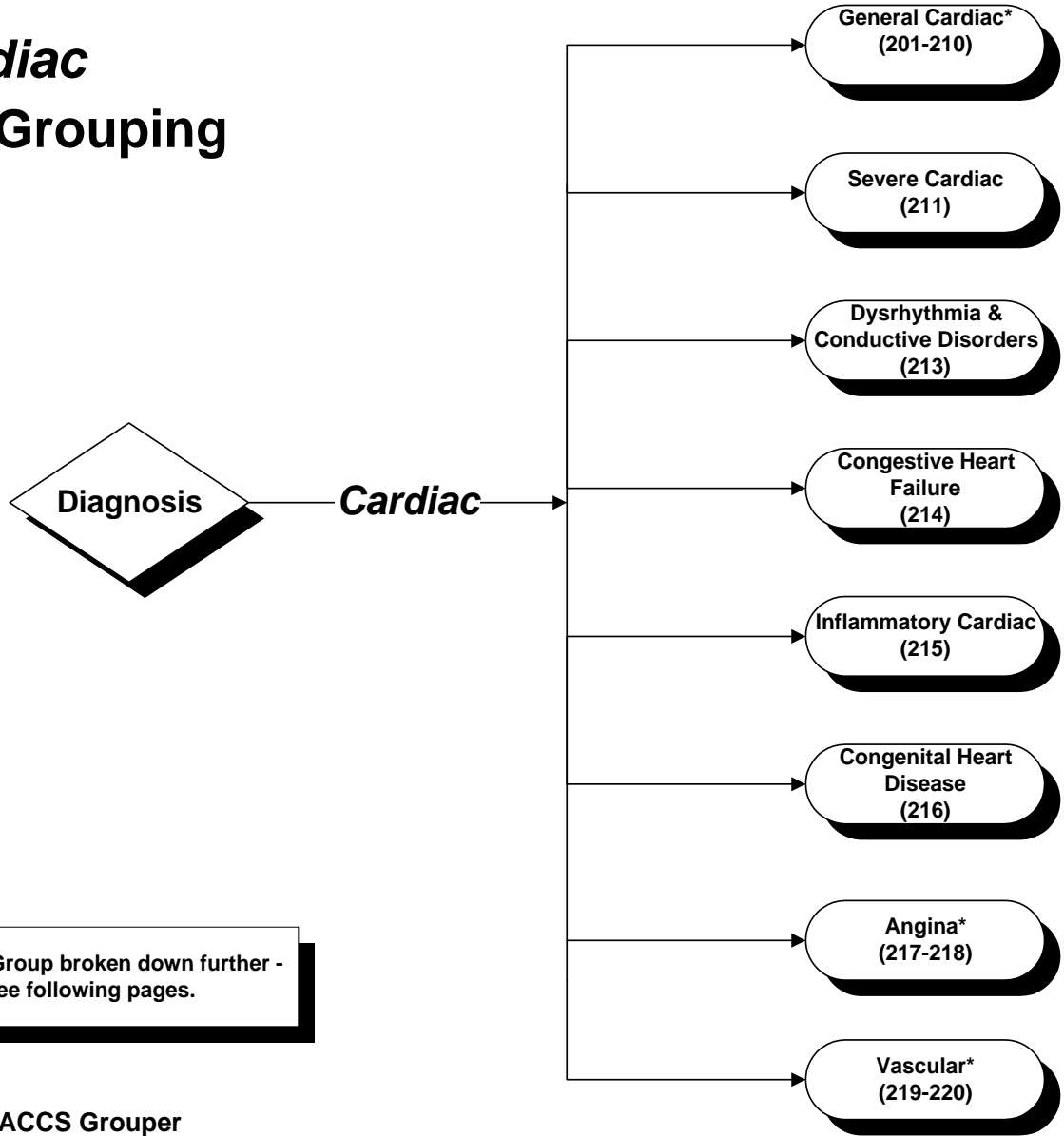

*Clinical Group broken down further - see following pages.

ACCS Grouper
04/96

Cardiac Clinical Grouping

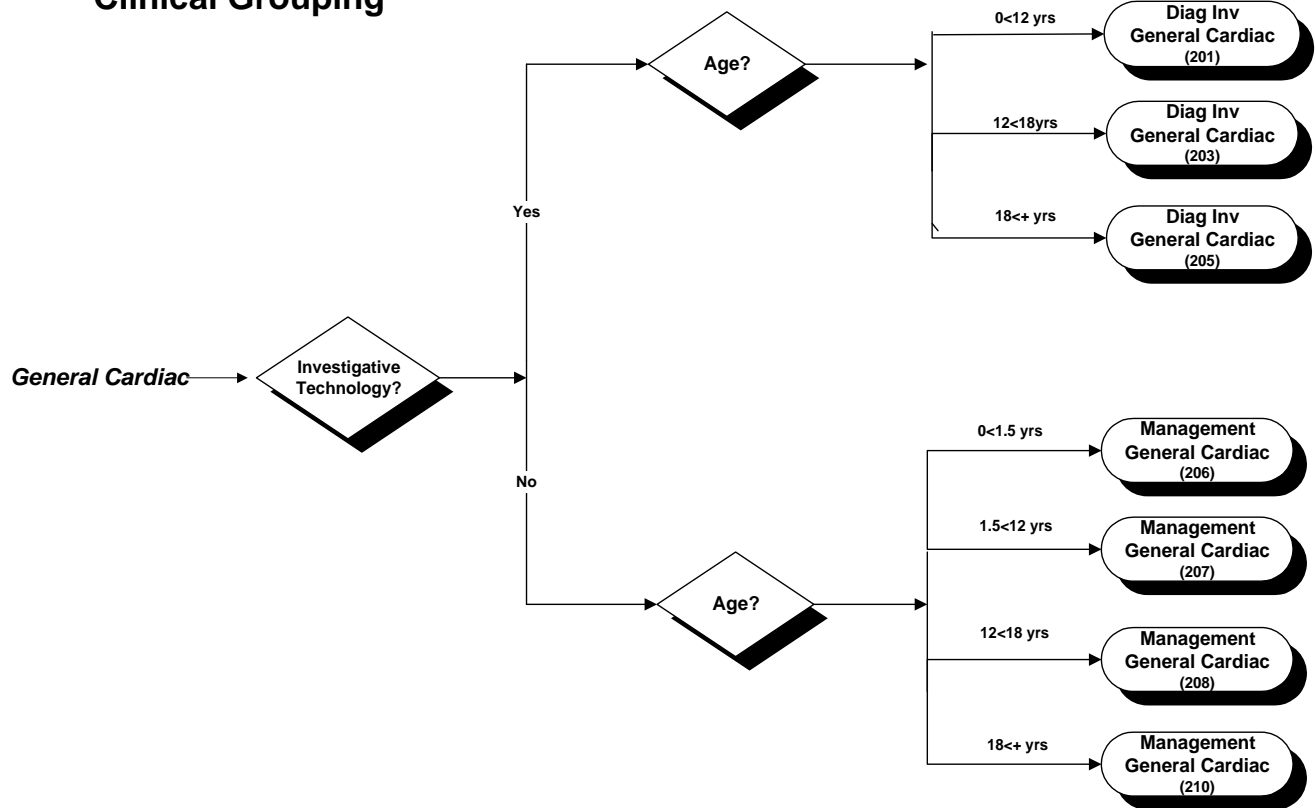

ACCS Grouper
04/96

Cardiac Clinical Grouping

Angina

Investigative
Technology?

Yes

Diag Inv Angina
(217)

No

Management
Angina
(218)

Vascular

Investigative
Technology?

Yes

Diag Inv Vascular
(219)

No

Management
Vascular
(220)

ACCS Grouper
04/00

Endocrine Clinical Grouping

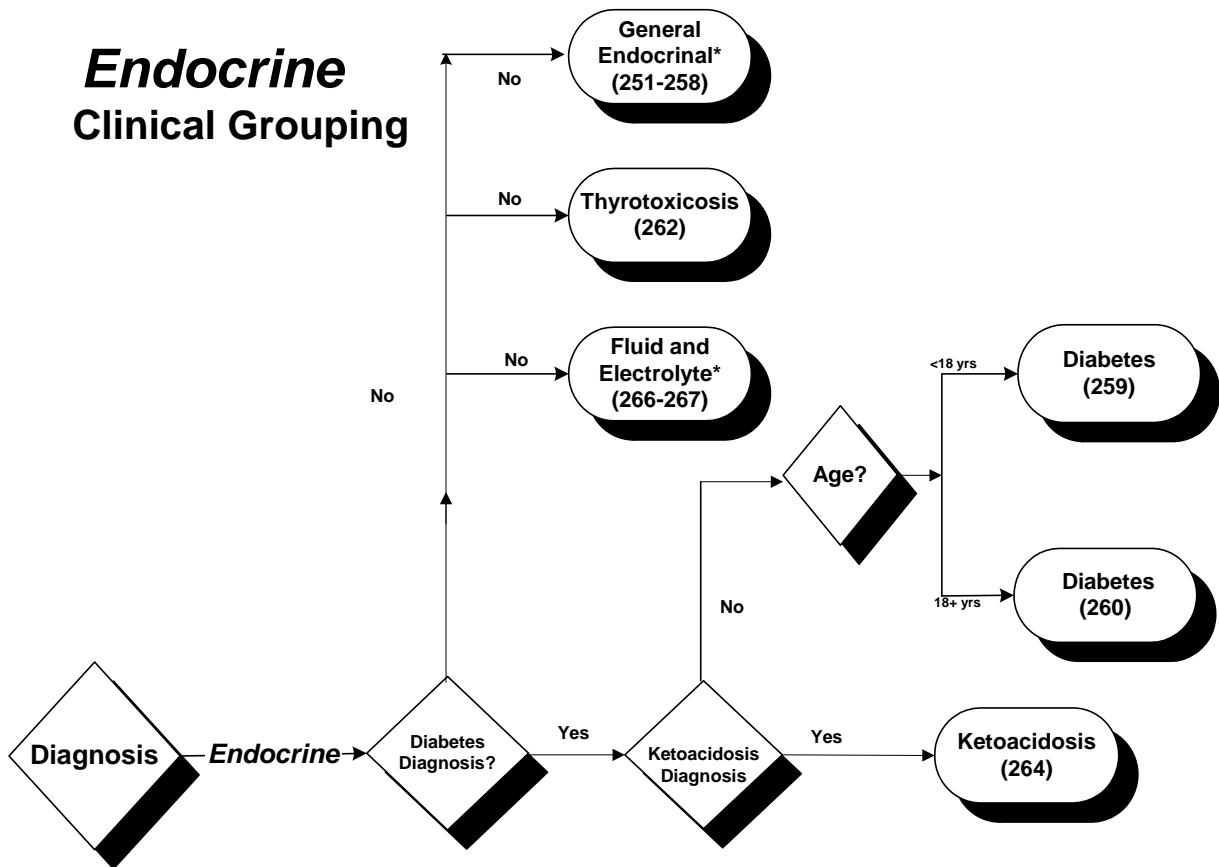

*Clinical Group broken down further - see following pages.

ACCS Groupers
04/00

Endocrine Clinical Grouping

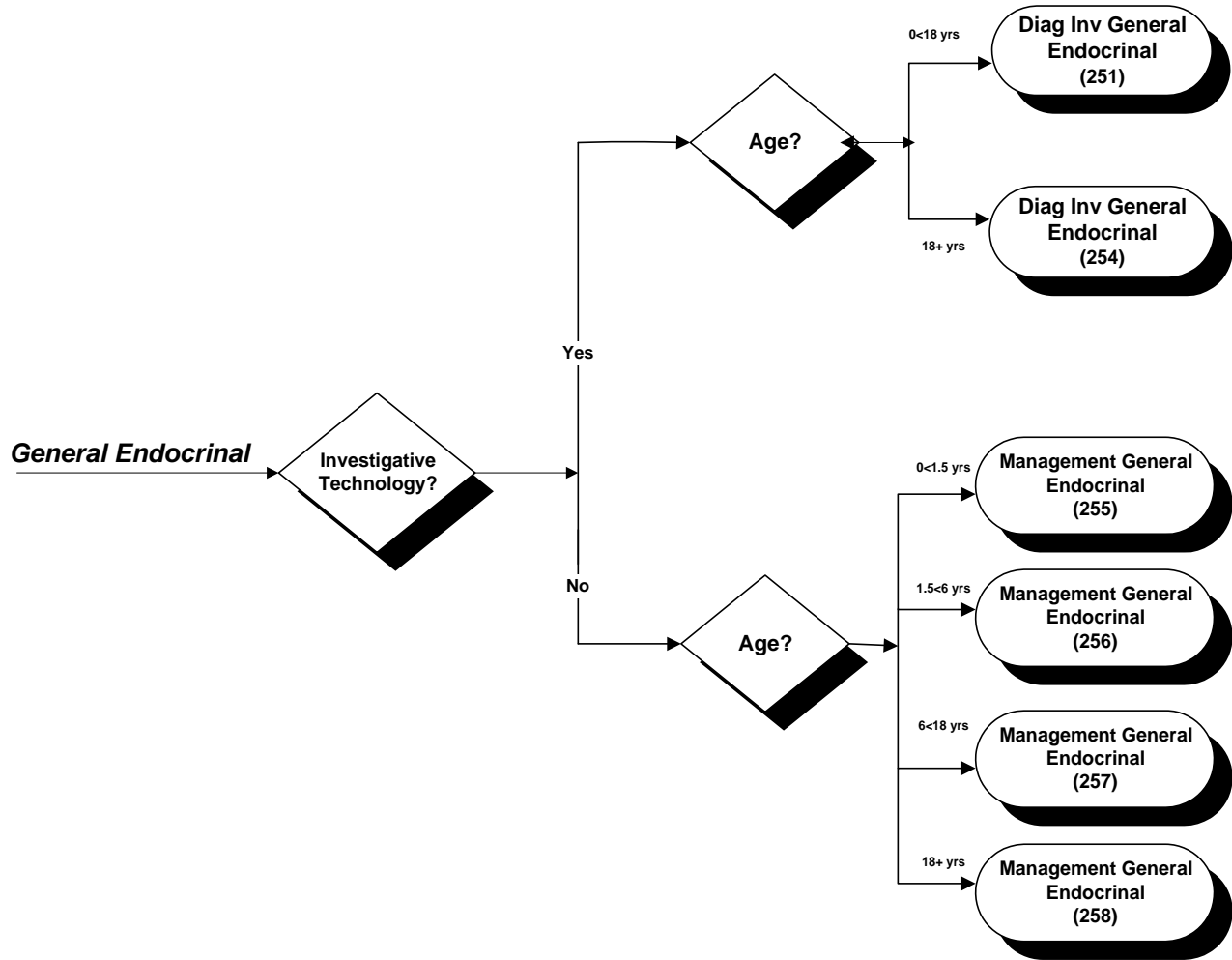

ACCS Grouper
04/00

Endocrine Clinical Grouping

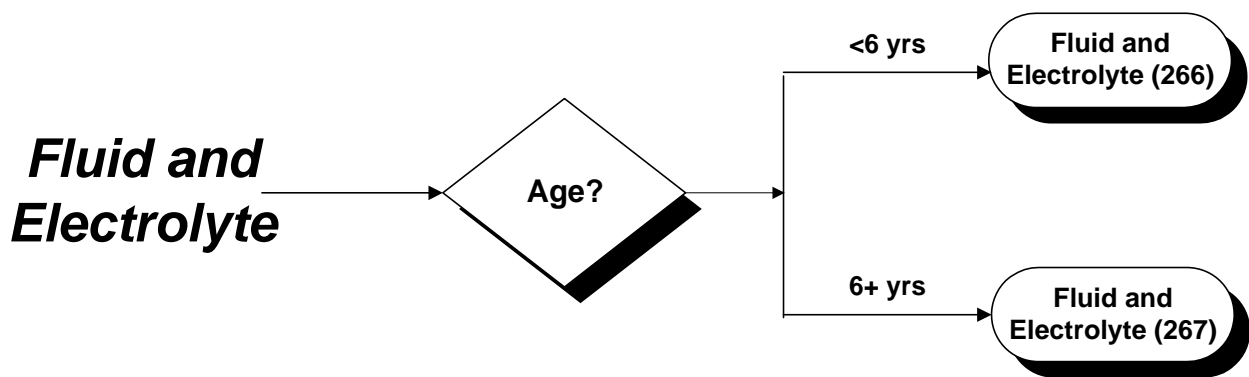

ACCS Grouper
04/00

ENT
(Ears, Nose,
Throat)
Clinical Grouping

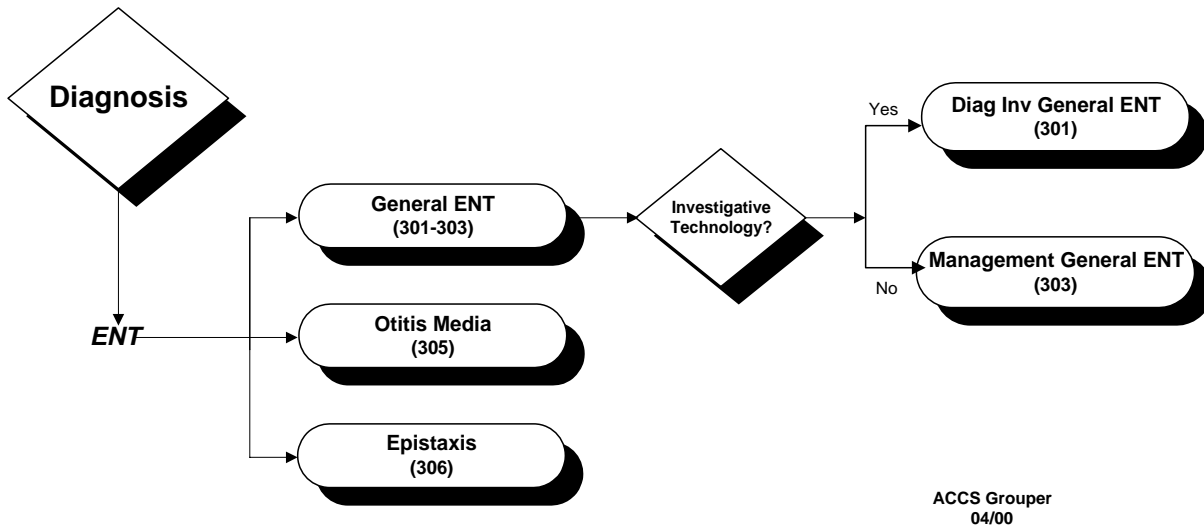

Genitourinary Clinical Grouping

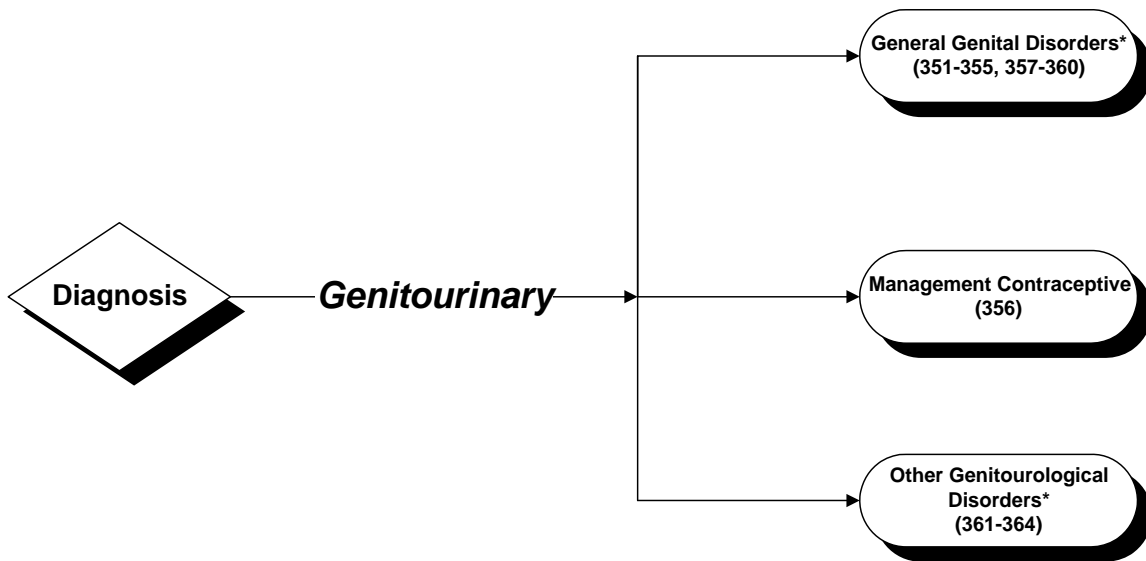

*Clinical Group broken down further -
see following pages.

**Genitourinary
Clinical Grouping**

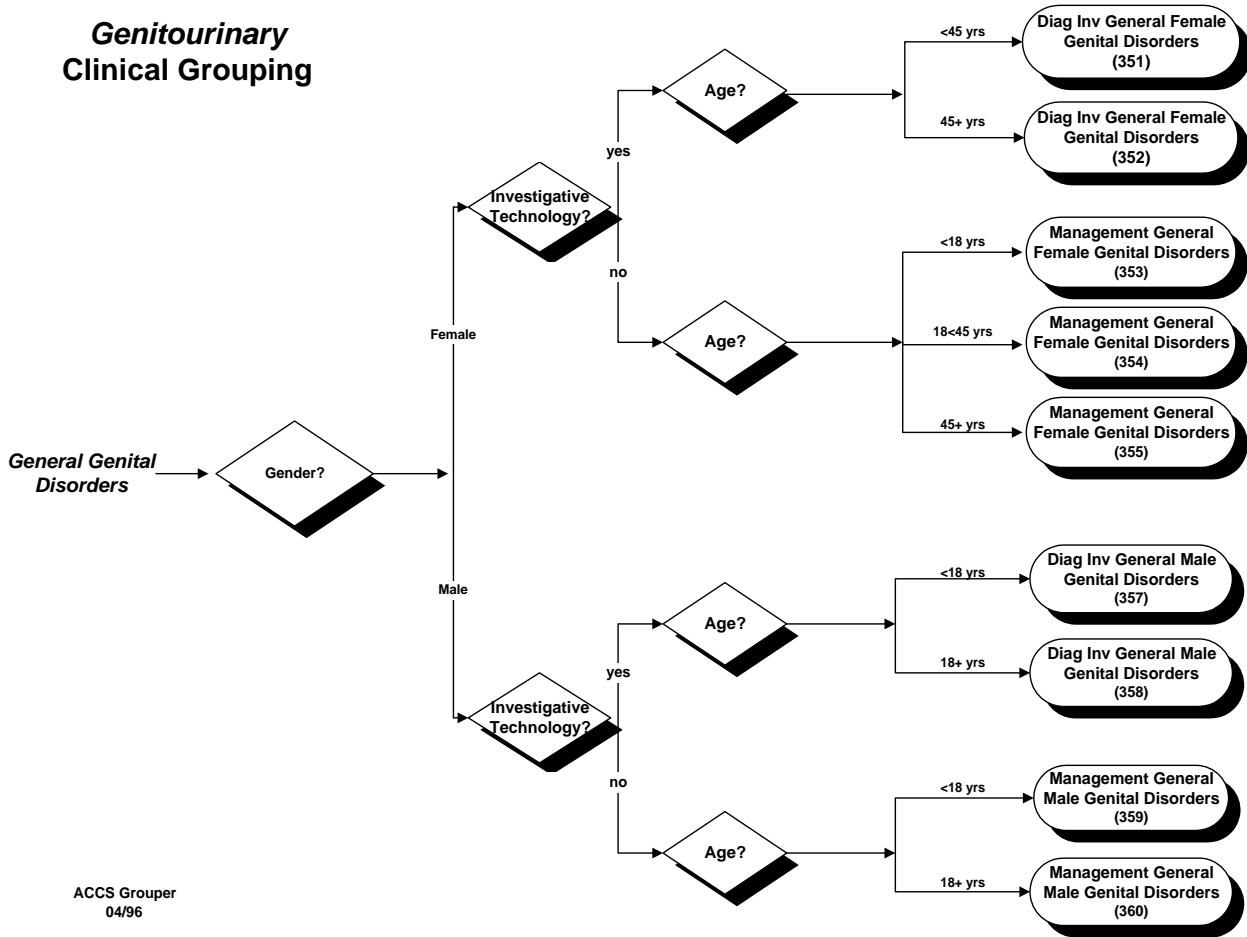

ACCS Grouper
04/96

Genitourinary Clinical Grouping

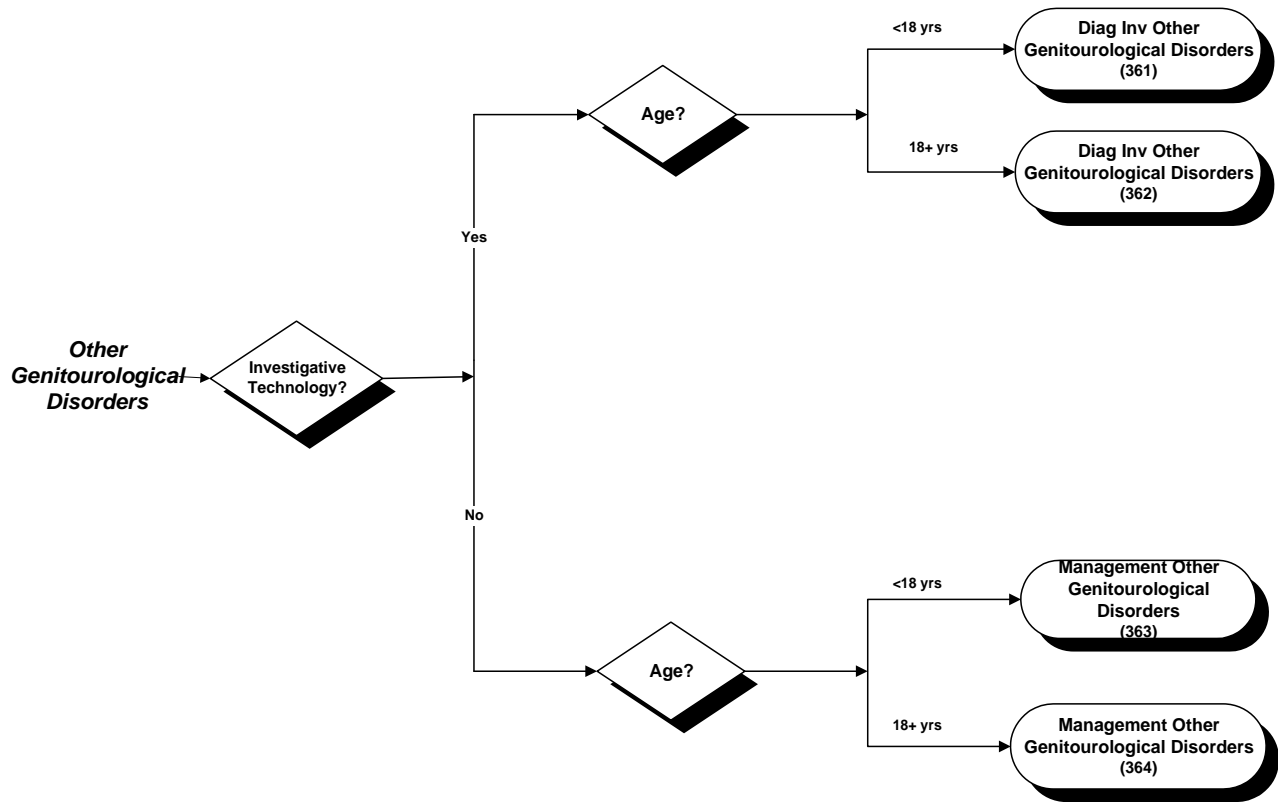

ACCS Grouper
04/96

Gastrointestinal Clinical Grouping

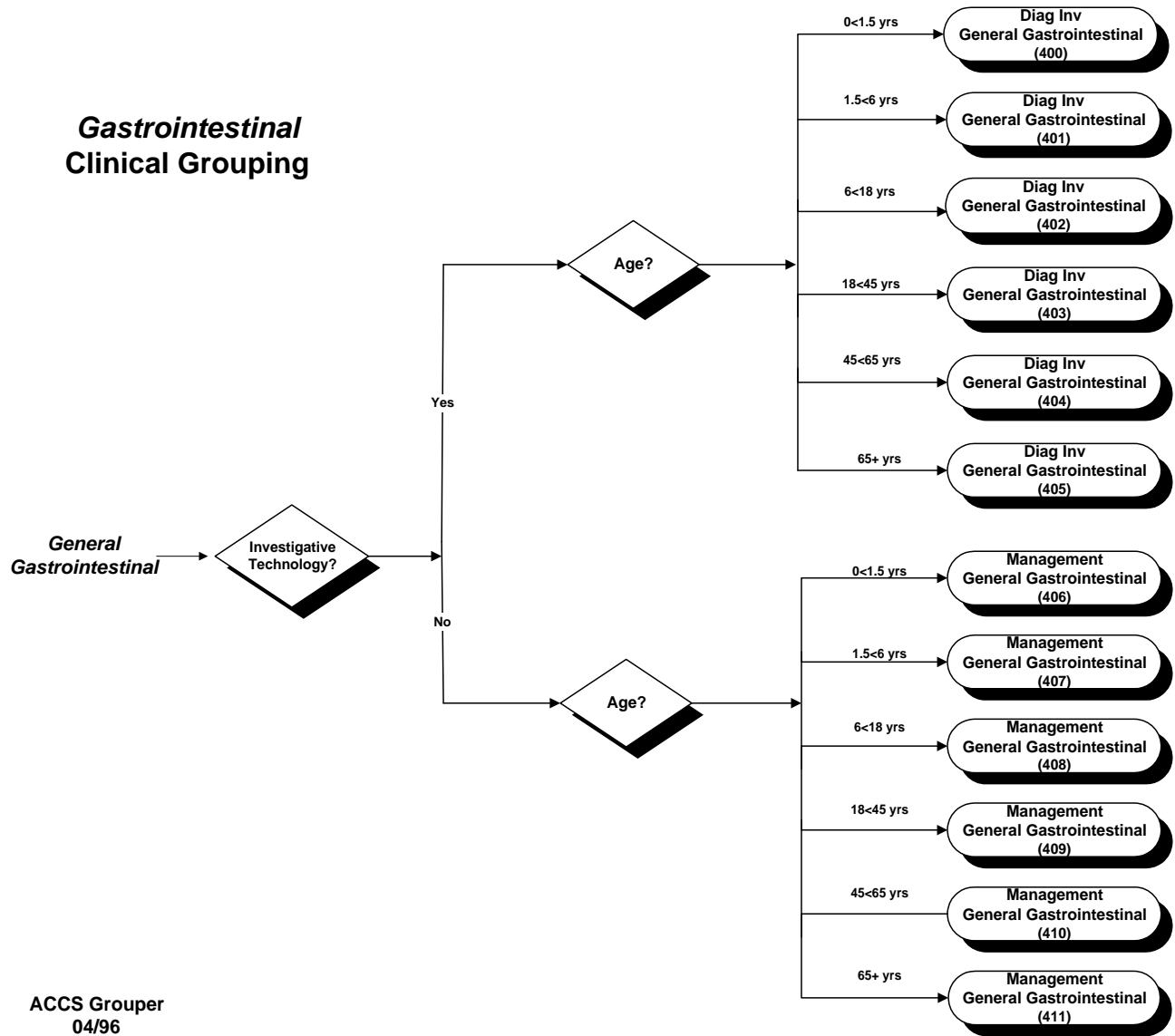

ACCS Grouper
04/96

Hematological Clinical Grouping

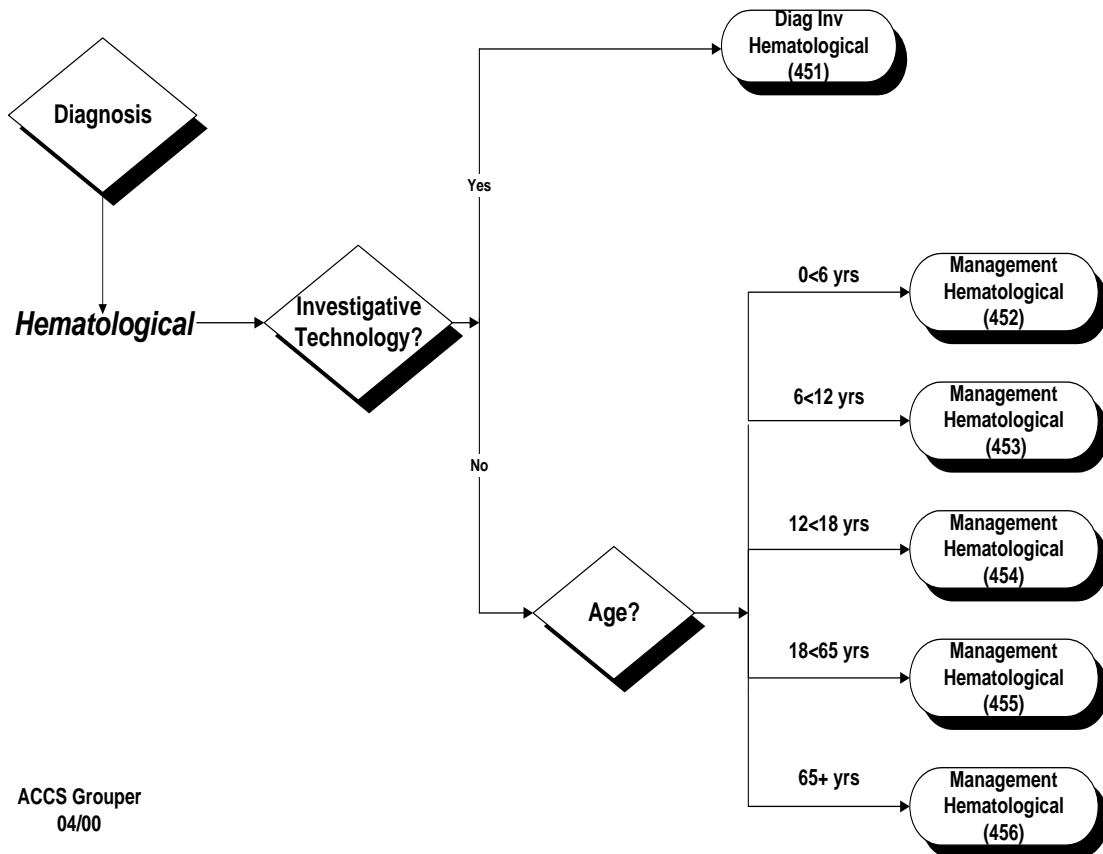

ACCS Grouper
04/00

Hepatobiliary Clinical Grouping

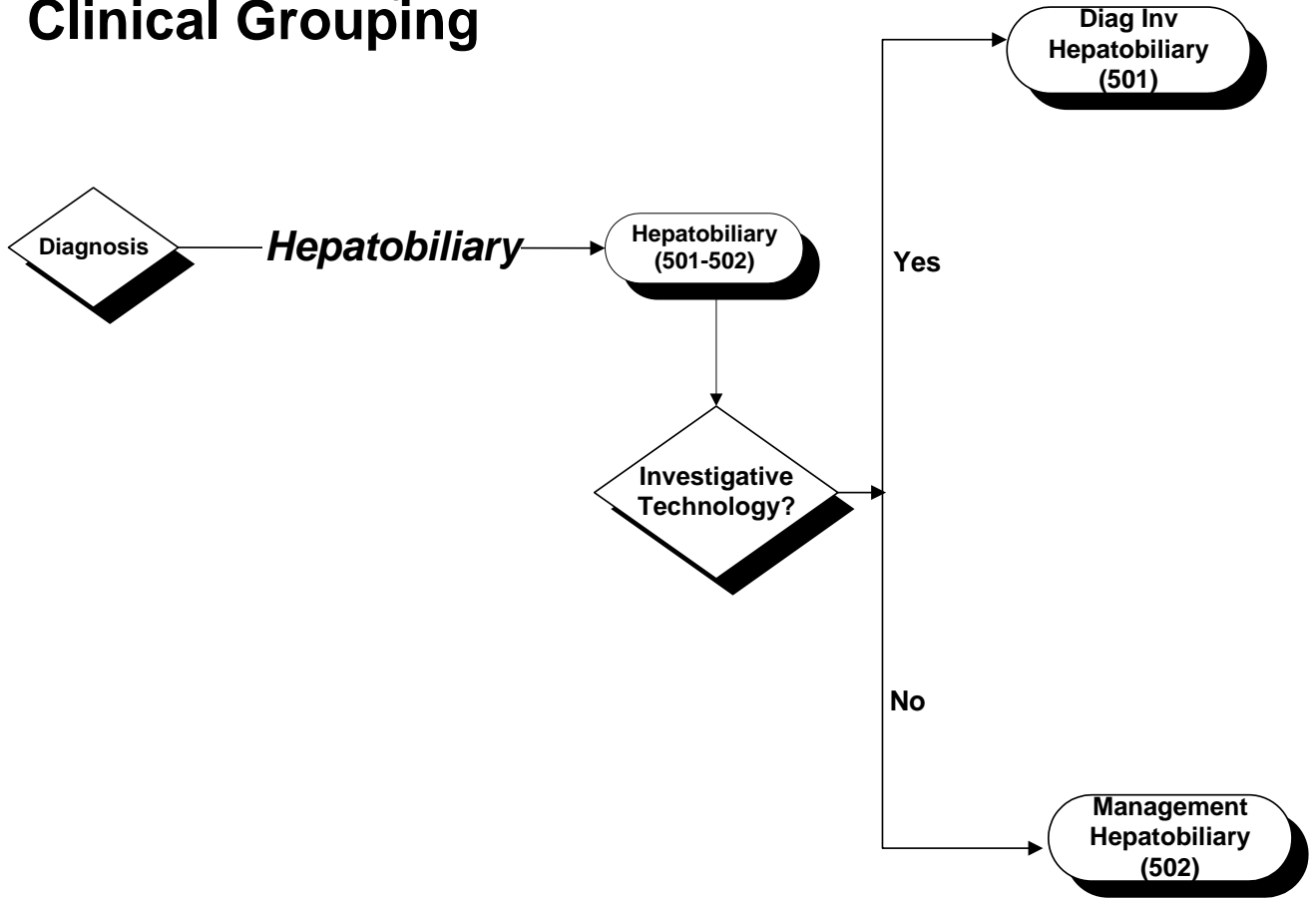

ACCS Grouper
04/96

Musculoskeletal Clinical Grouping

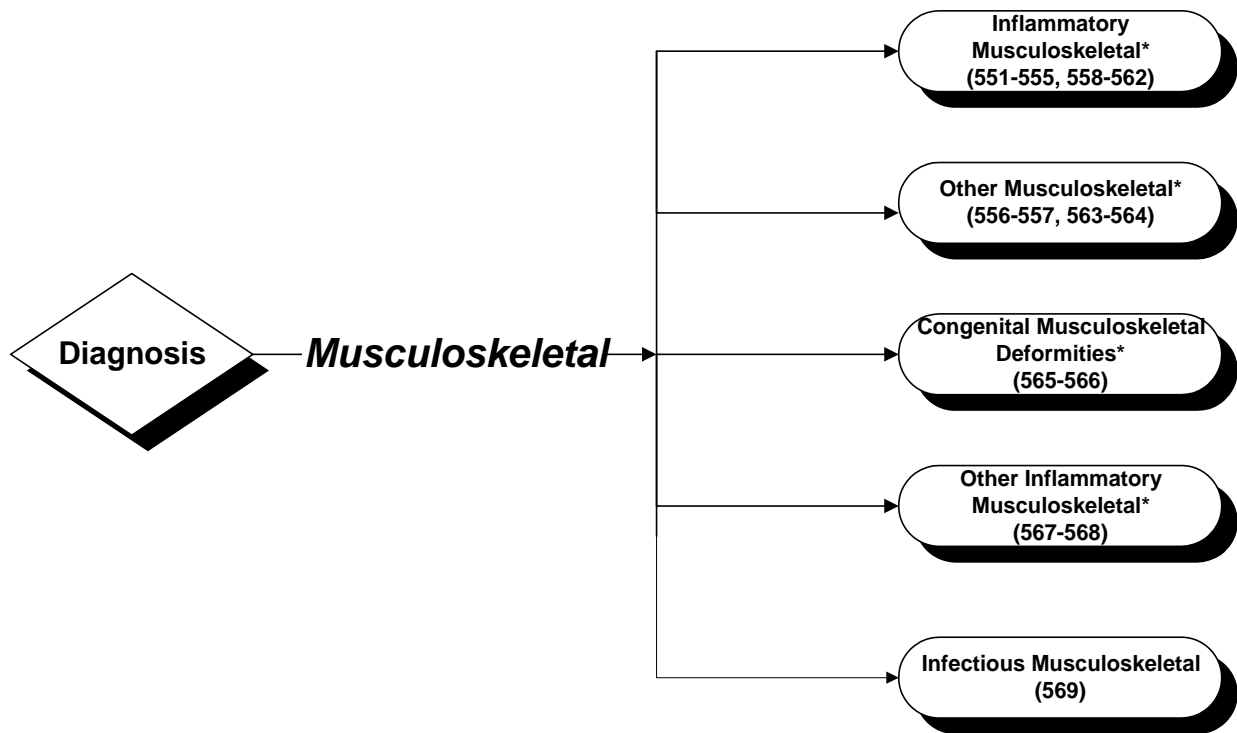

*Clinical Group broken down further - see following pages.

ACCS Grouper
04/96

**Musculoskeletal
Clinical Grouping**

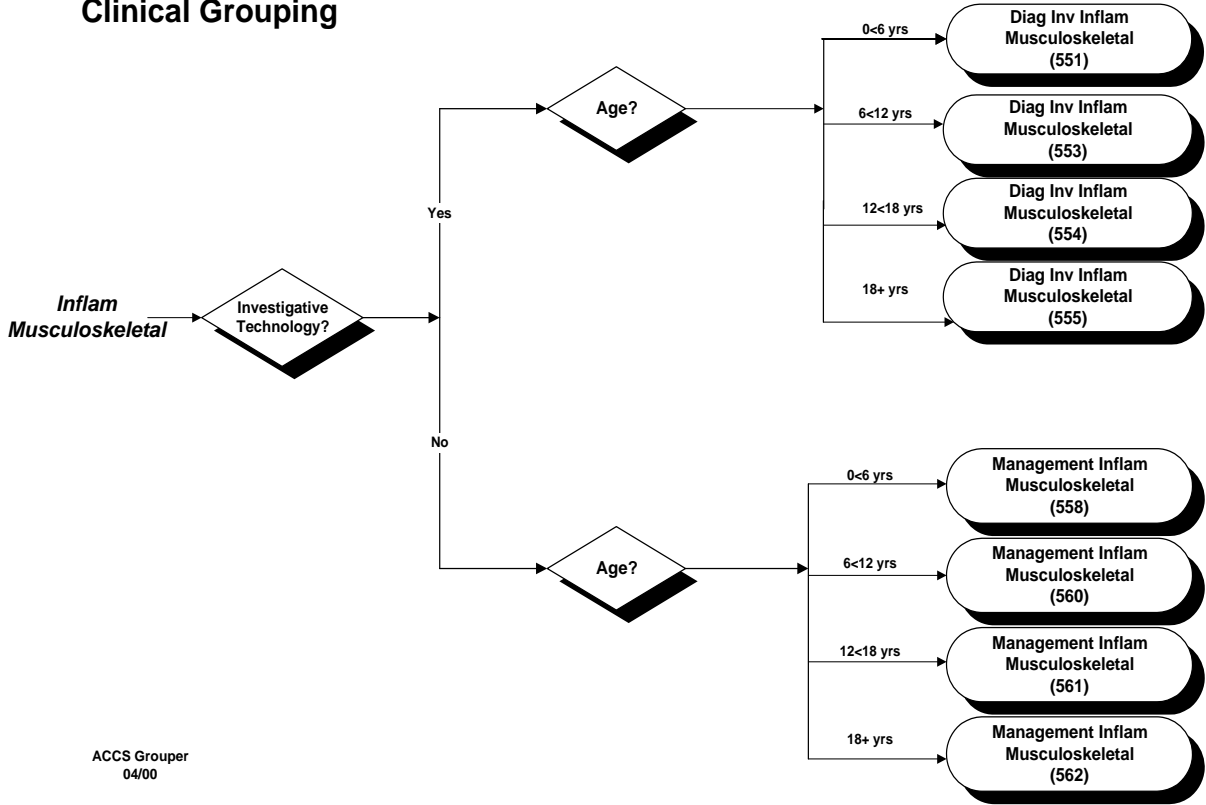

ACCS Grouper
04/00

Musculoskeletal Clinical Grouping

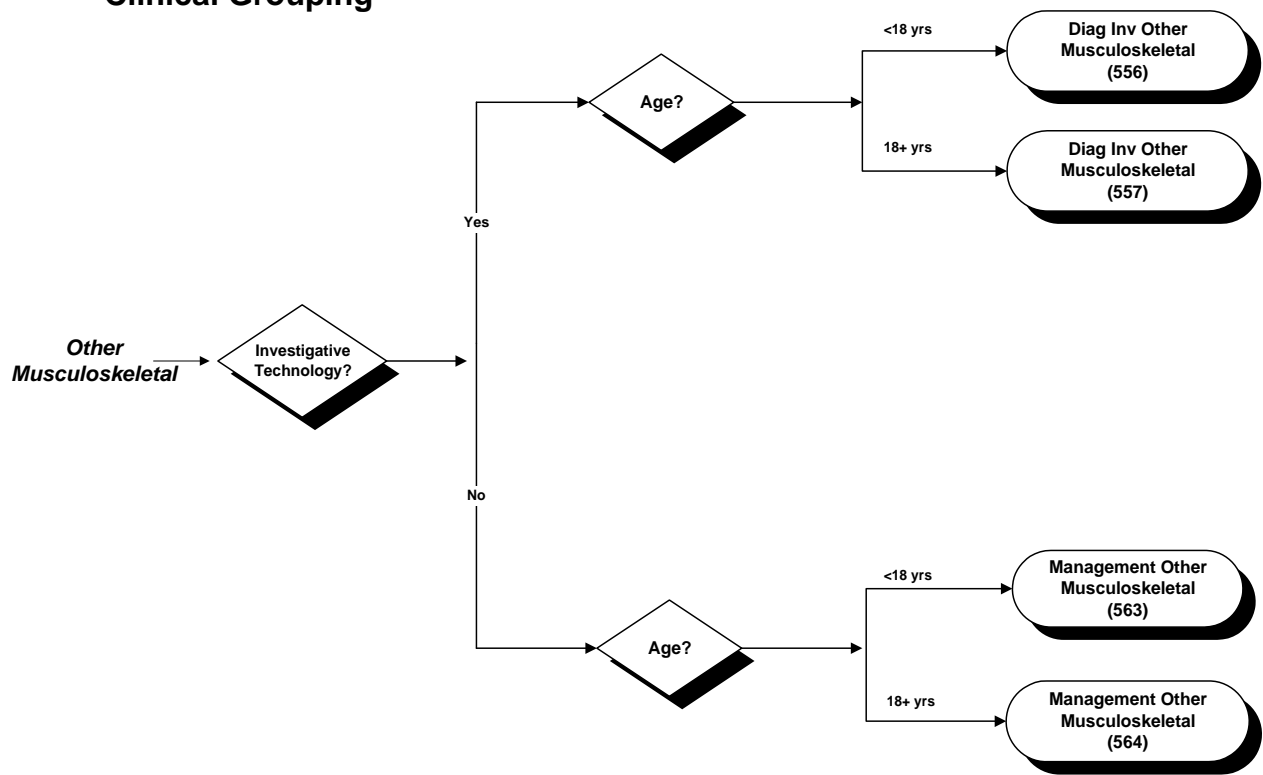

ACCS Grouper
04/96

Musculoskeletal Clinical Grouping

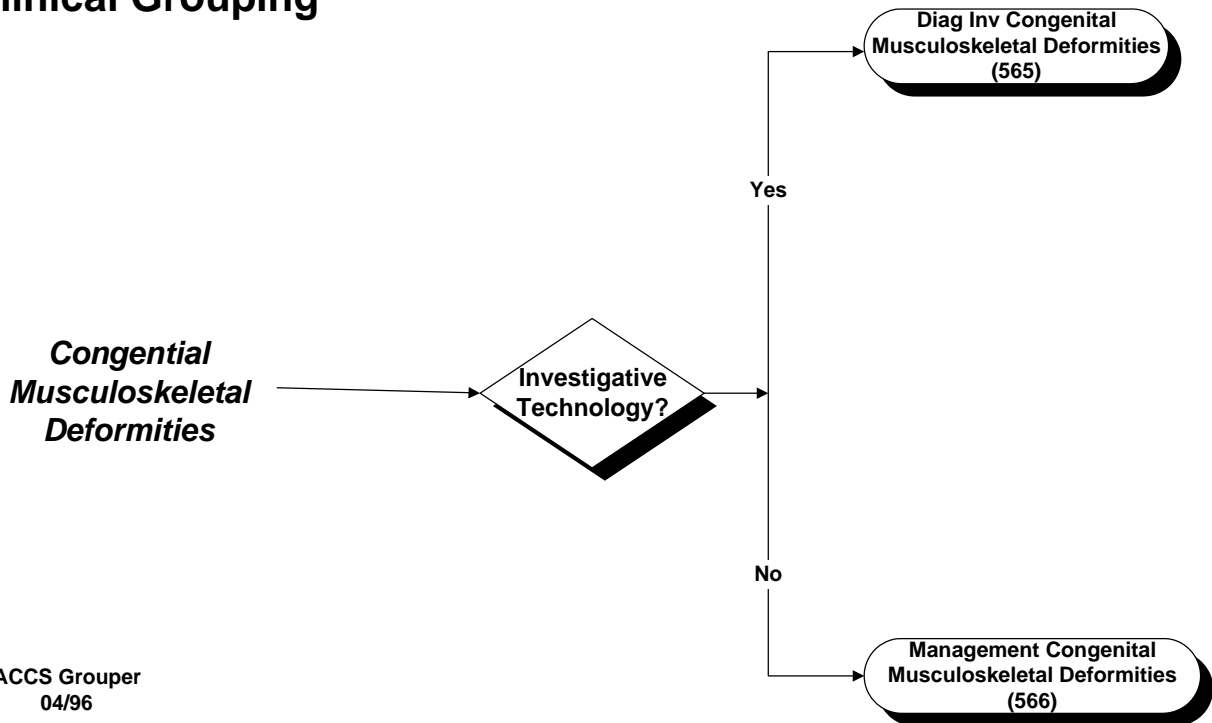

ACCS Grouper
04/96

Musculoskeletal Clinical Grouping

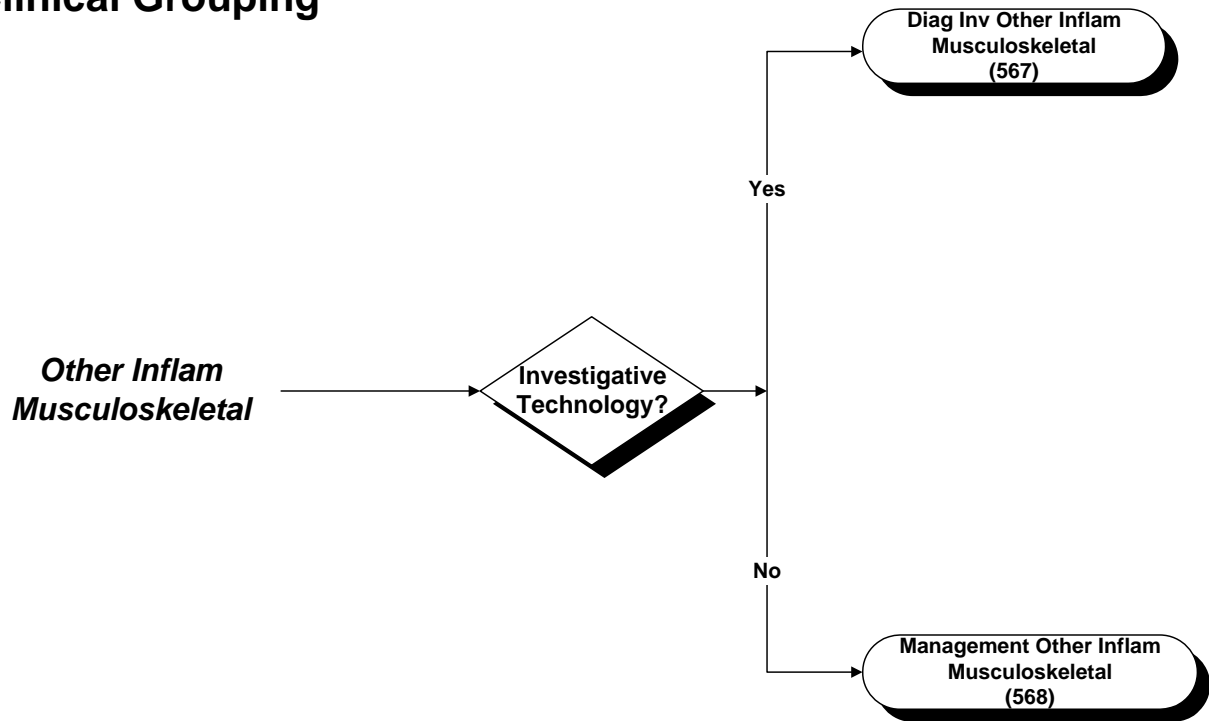

ACCS Grouping
04/96

Neurology Clinical Grouping

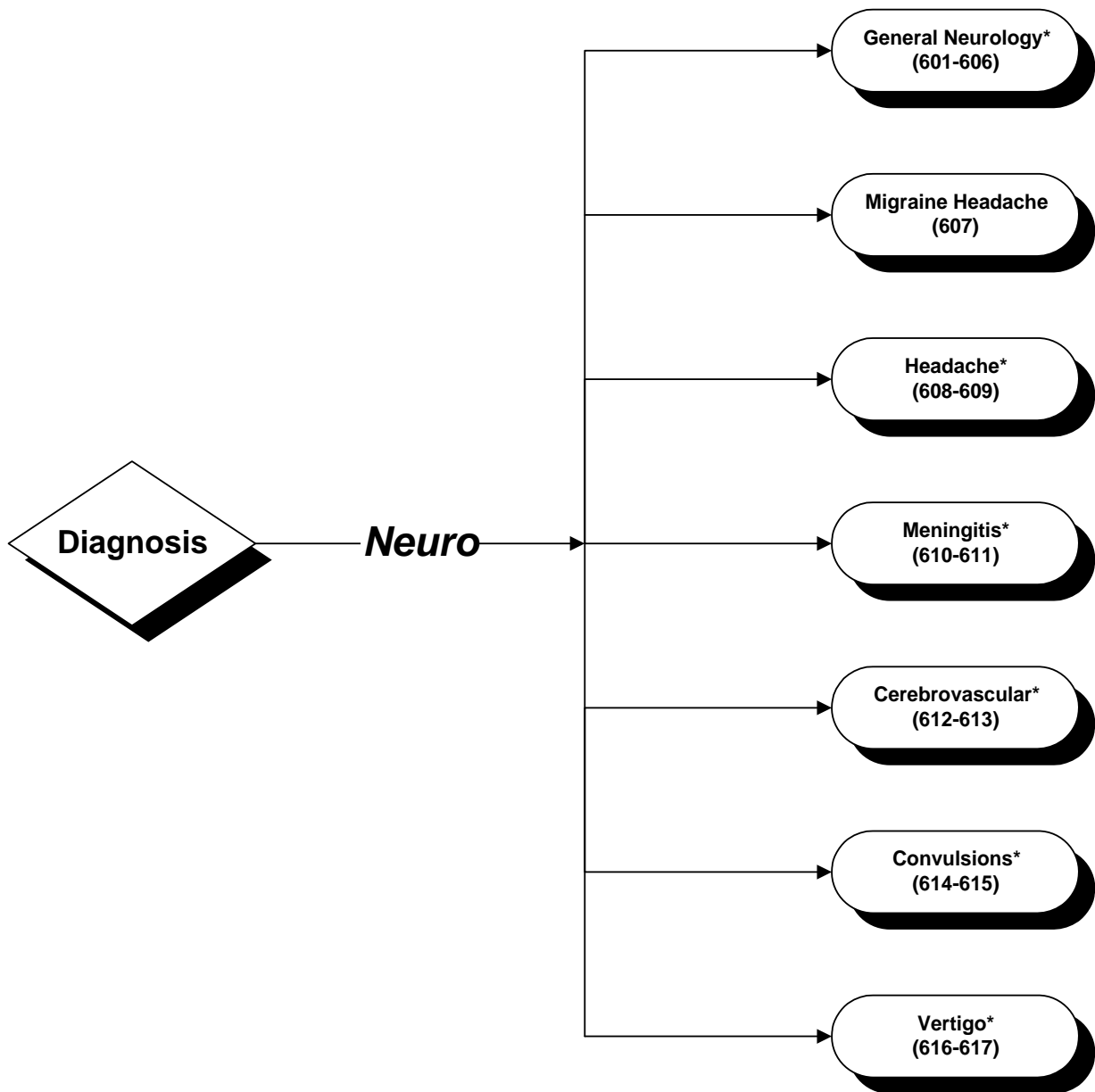

*Clinical Group broken down further - see following pages.

ACCS Grouper
04/96

Neurology Clinical Grouping

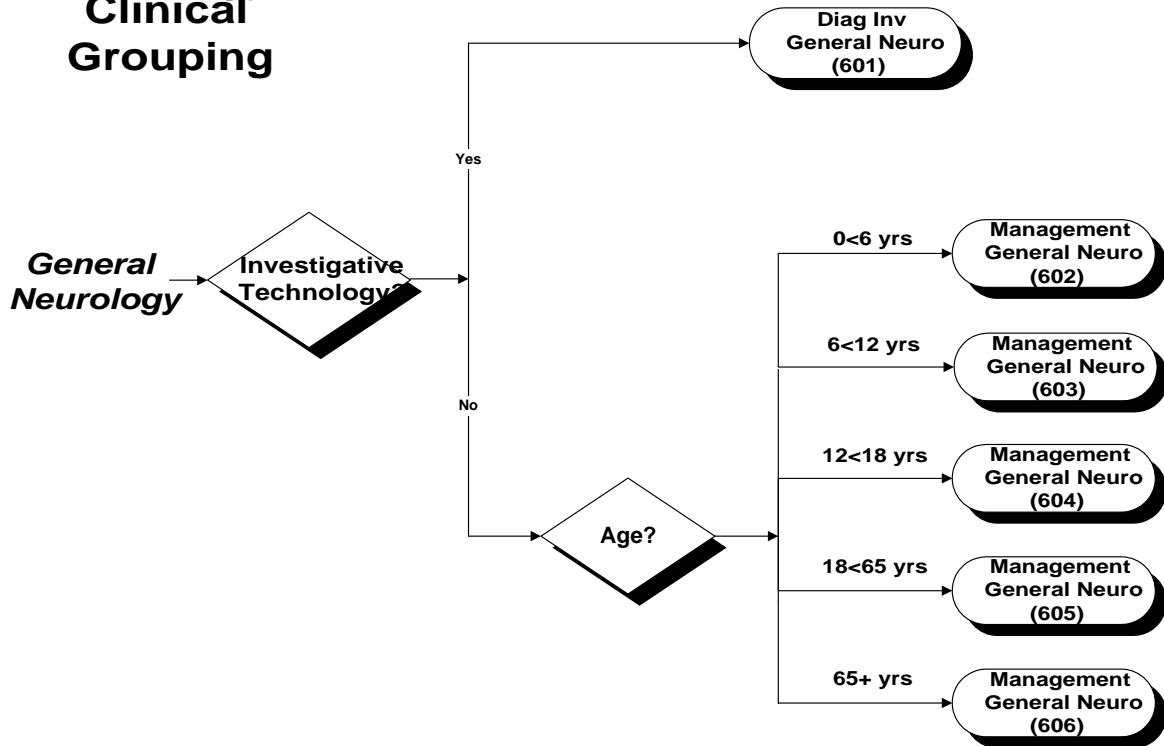

ACCS Grouper
04/96

ACCS CELL
607 Migraine Headache

**Neurology
Clinical Grouping**

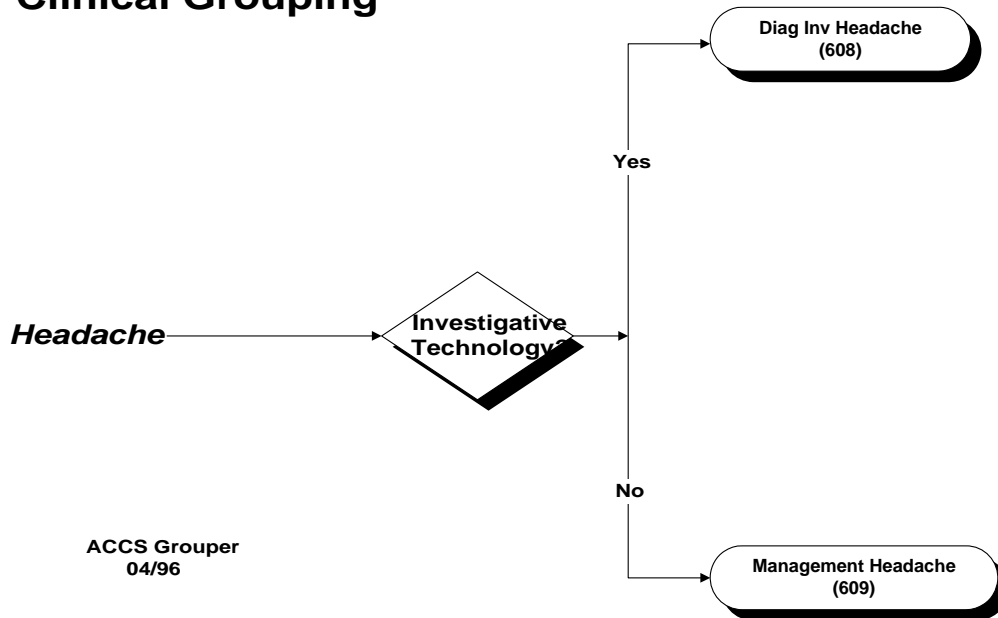

ACCS CELL
608-609 Headache

Neurology Clinical Grouping

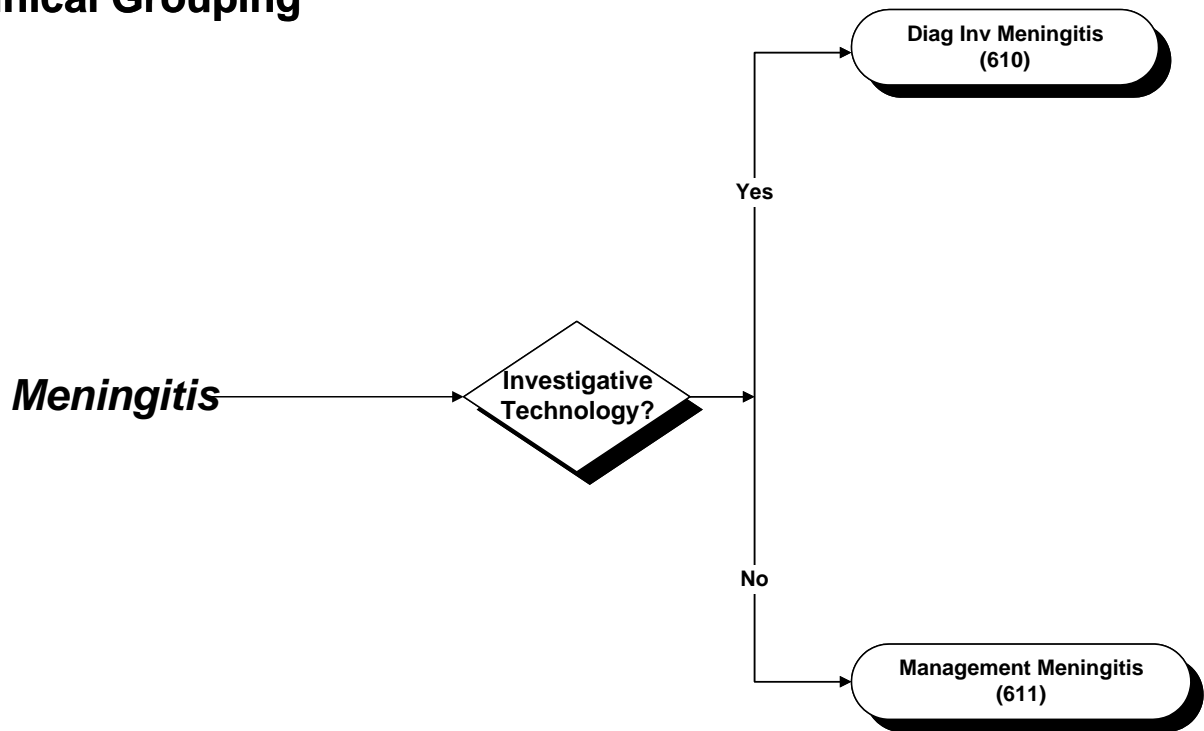

ACCS Grouper
04/96

**Neurology
Clinical Grouping**

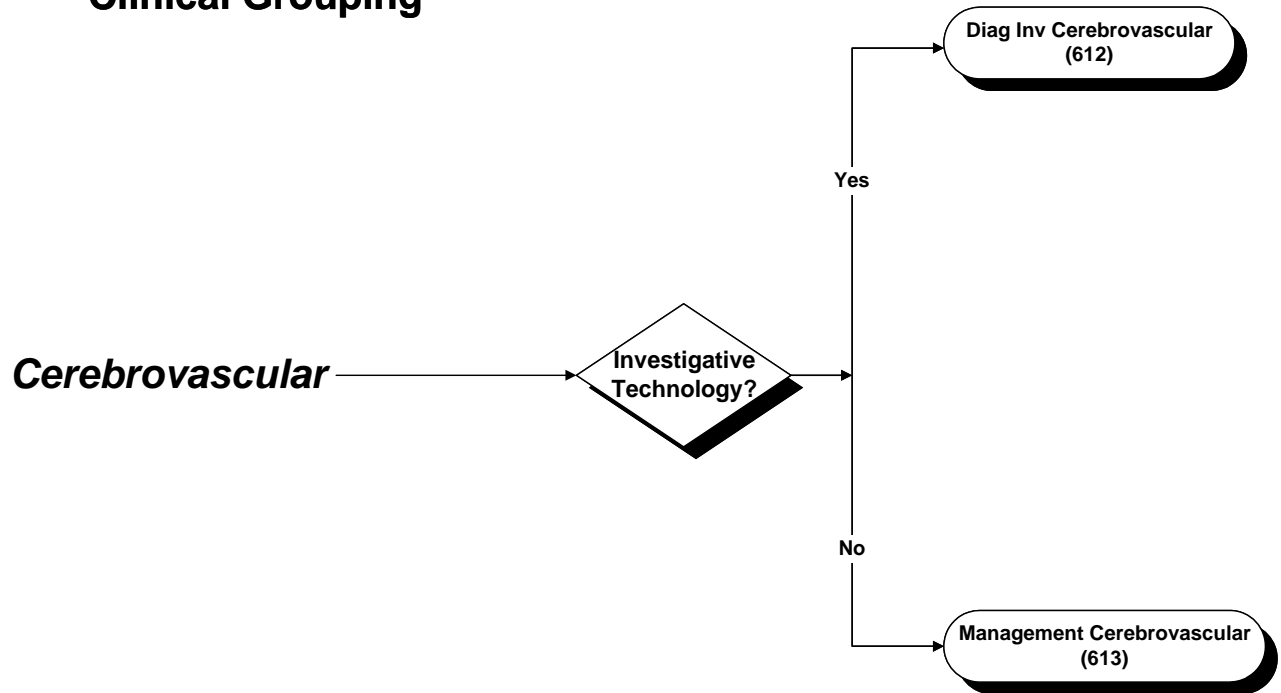

ACCS Grouper
04/96

Neurology Clinical Grouping

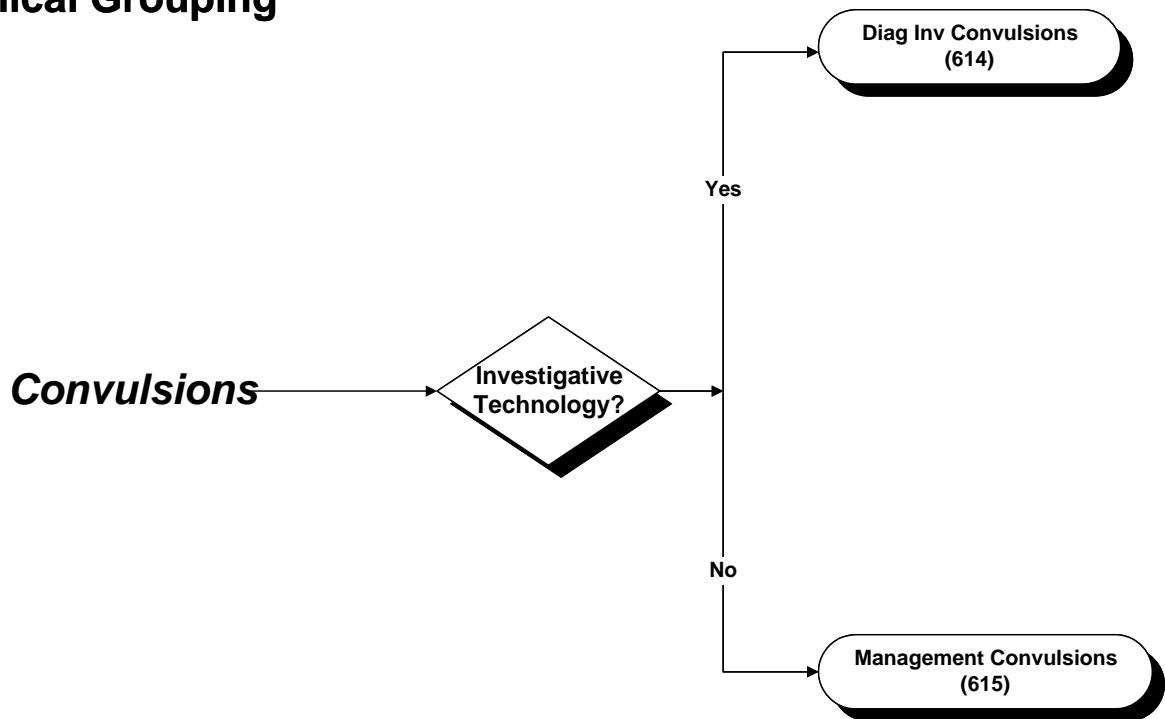

ACCS Grouper
04/96

Neurology
Clinical Grouping

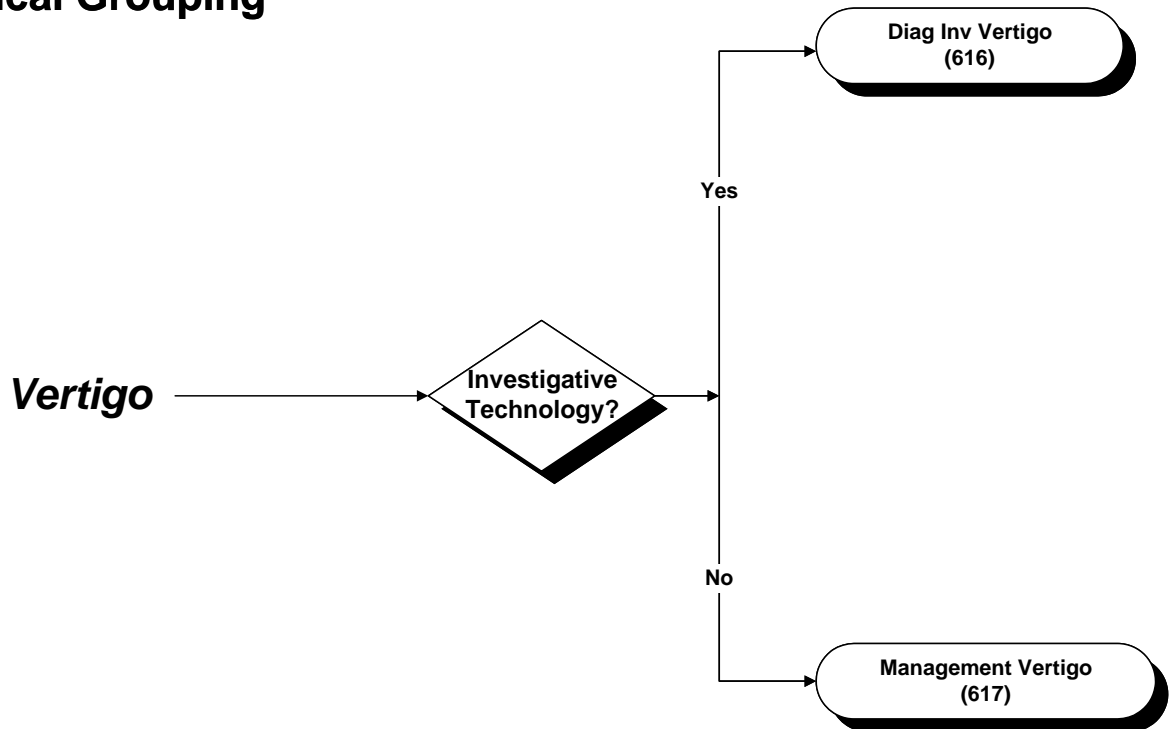

ACCS Grouper
04/96

Obstetrics/Newborn Clinical Grouping

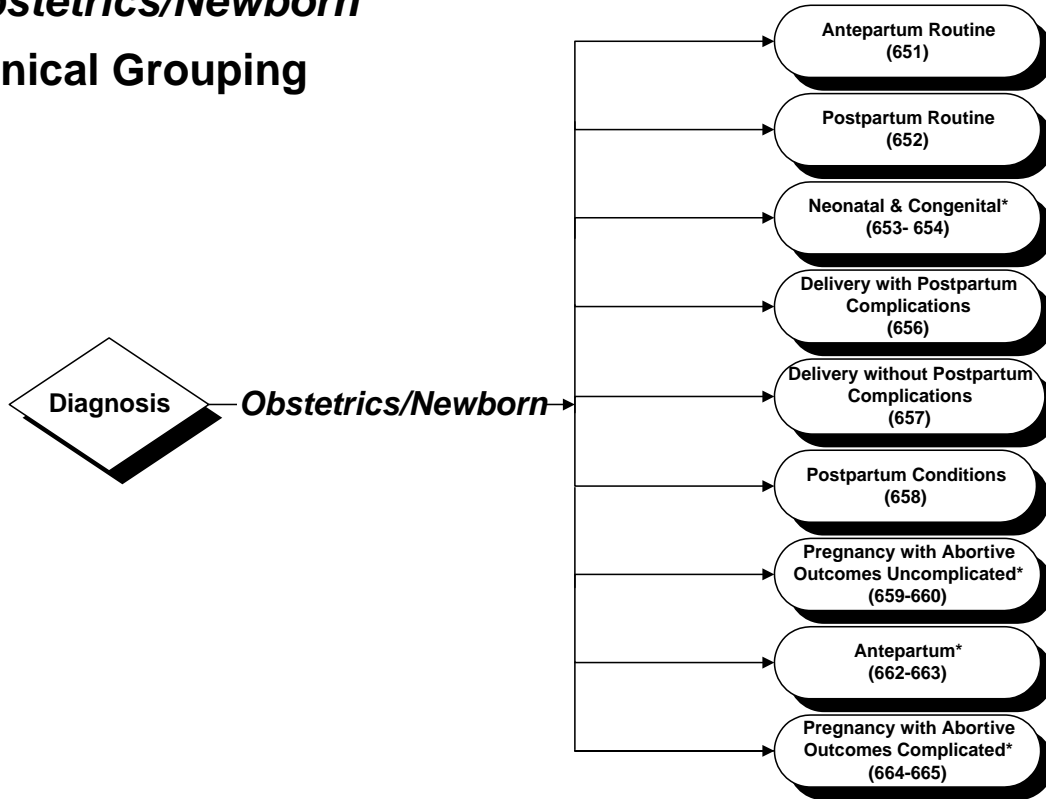

*Clinical Group broken down further - see following pages.

ACCS Grouper
04/96

Obstetrics/Newborn Clinical Grouping

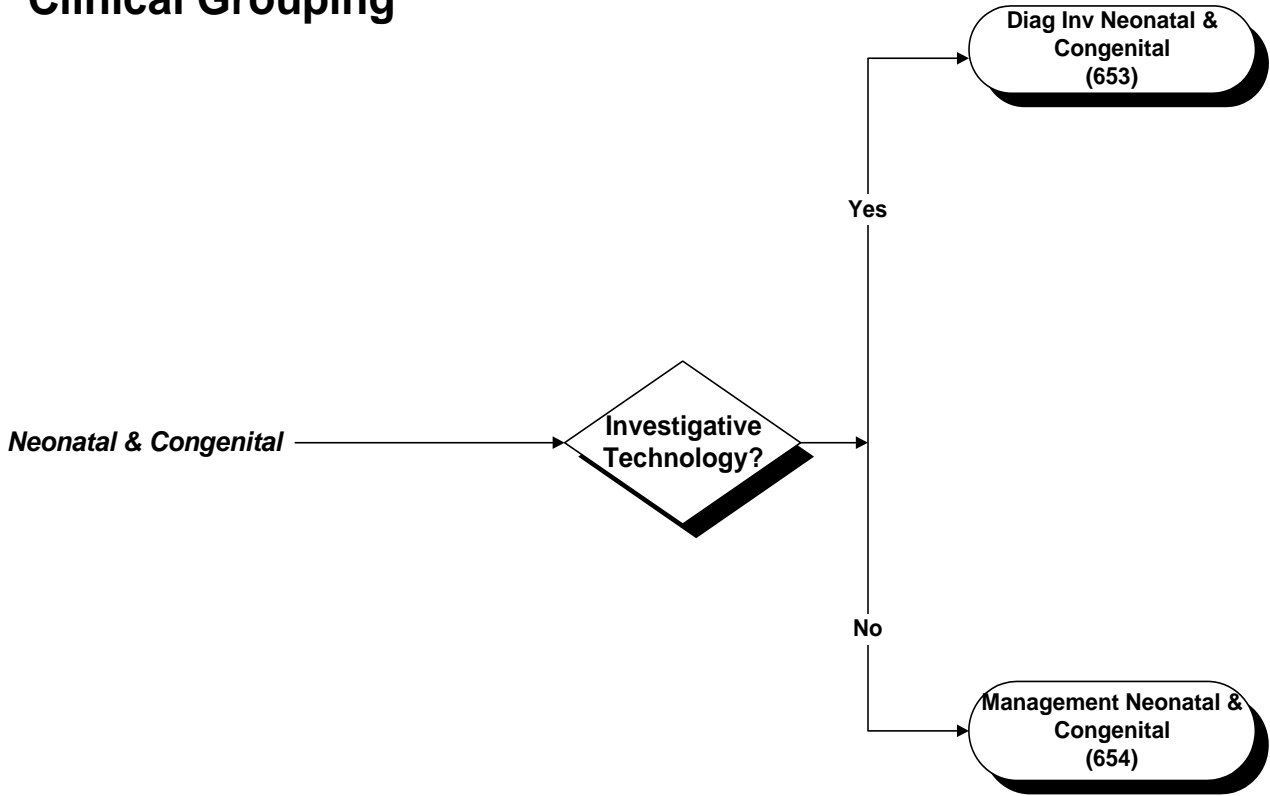

ACCS Grouper
04/96

Obstetrics/Newborn Clinical Grouping

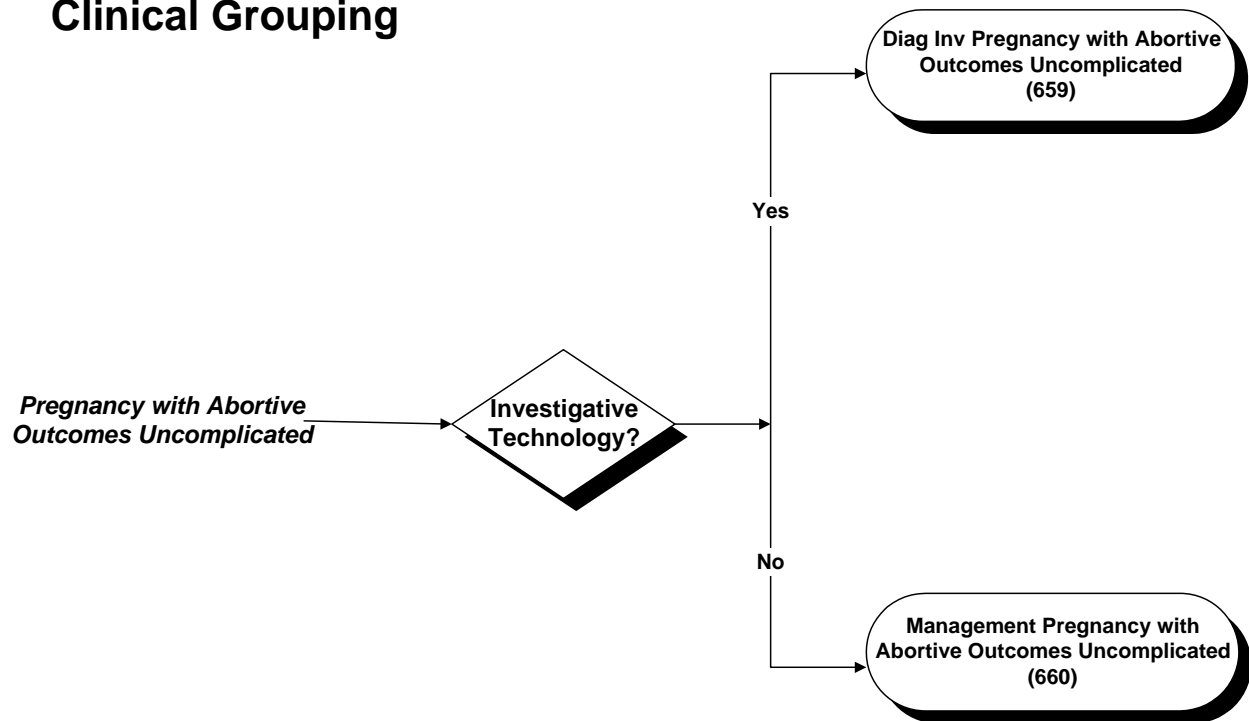

ACCS Grouper
04/96

Obstetrics/Newborn Clinical Grouping

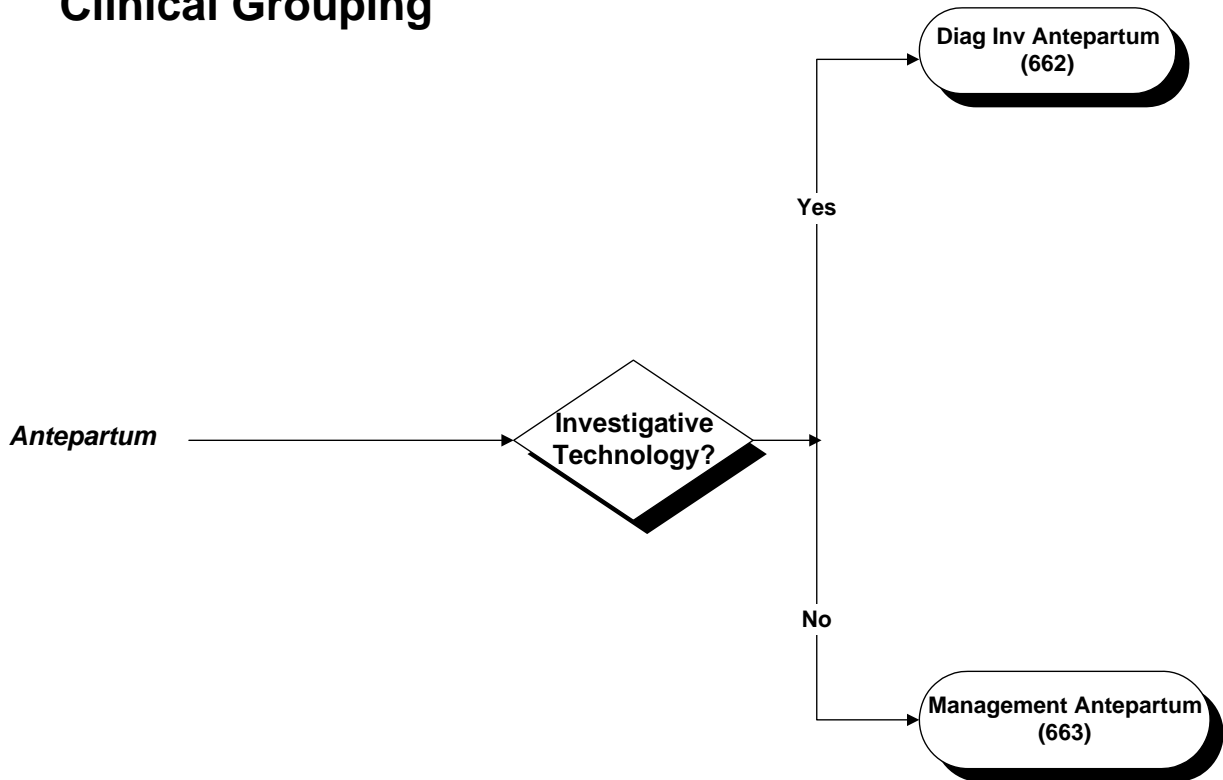

ACCS Grouper
04/96

Obstetrics/Newborn Clinical Grouping

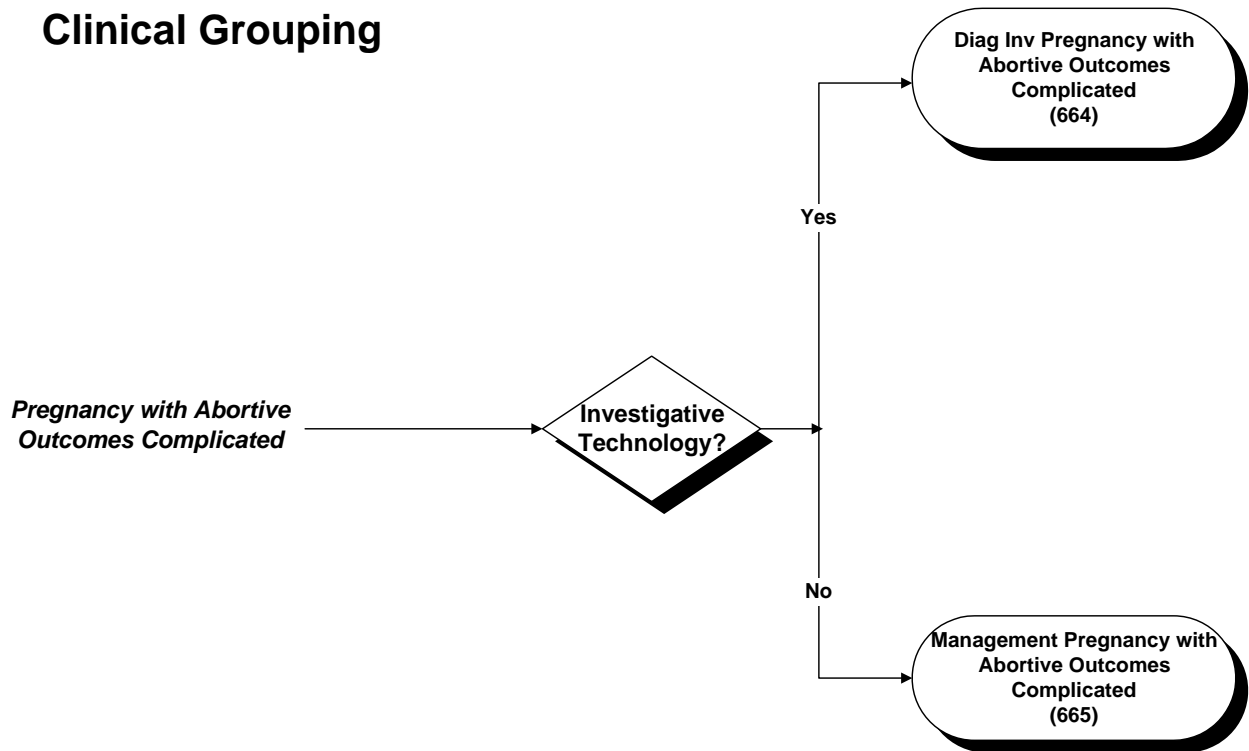

ACCS Grouper
04/96

Oncology Clinical Grouping

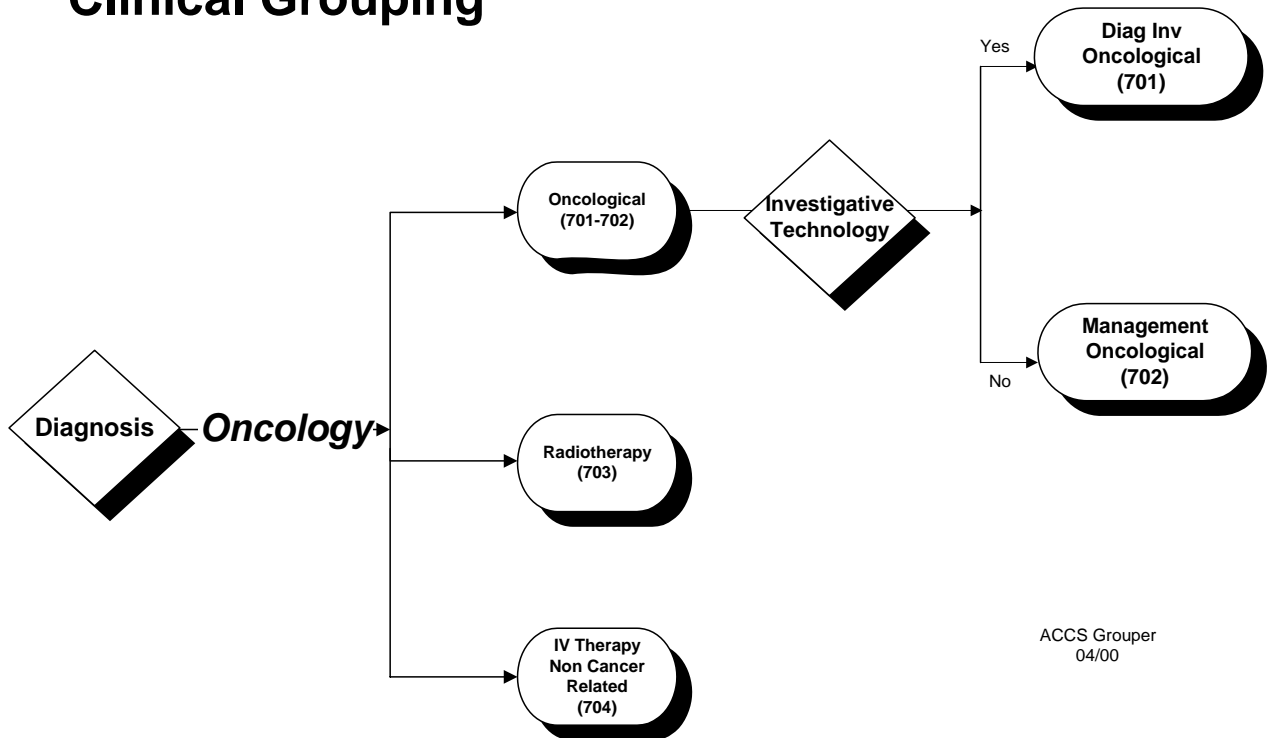

ACCS Grouper
04/00

Ophthalmology Clinical Grouping

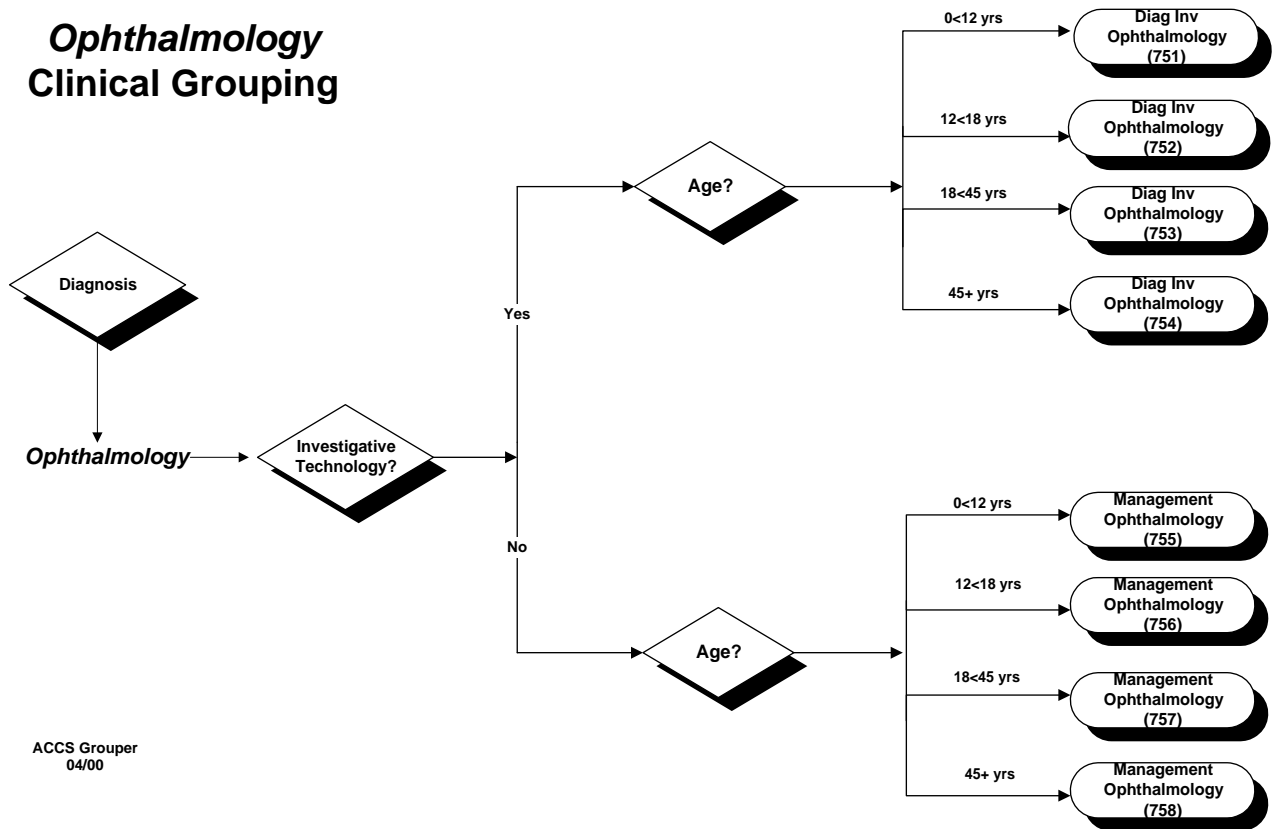

ACCS Grouper
04/00

Psychiatry Clinical Grouping

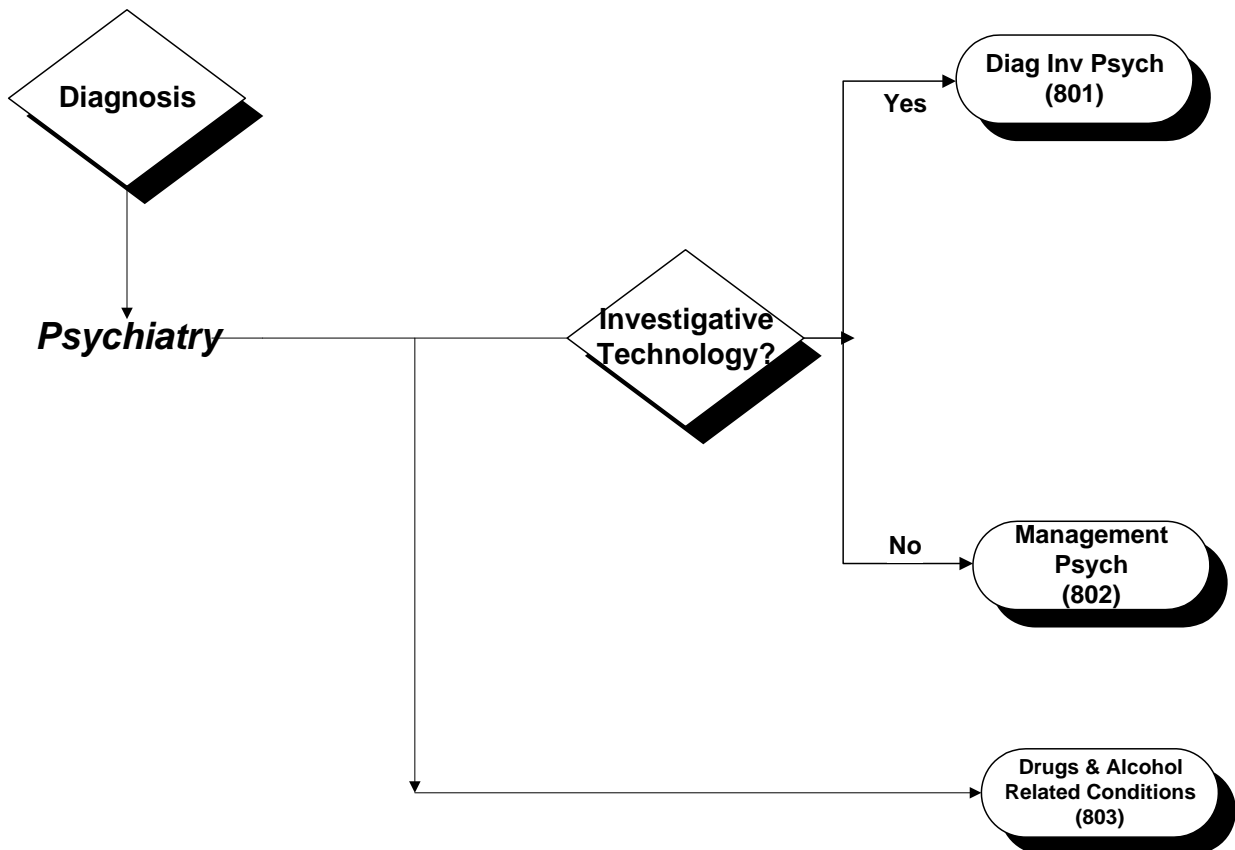

ACCS Grouper
04/00

Respiratory Clinical Grouping

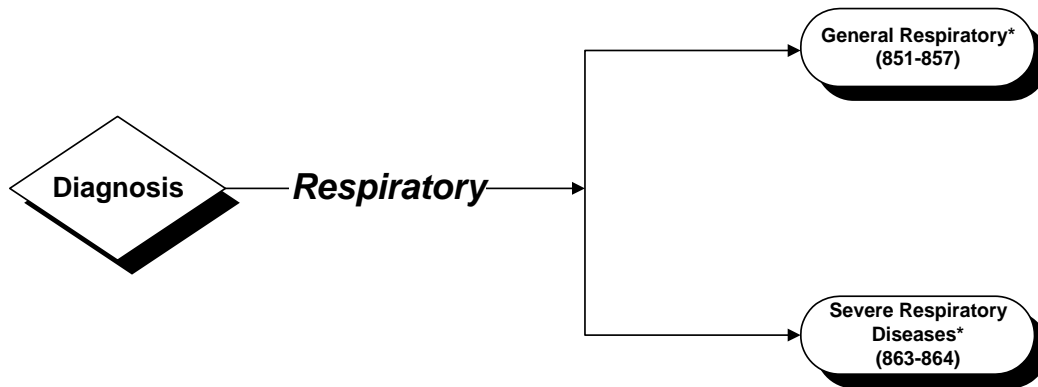

*Clinical Group broken down further - see following pages.

ACCS Grouping
04/96

Respiratory Clinical Grouping

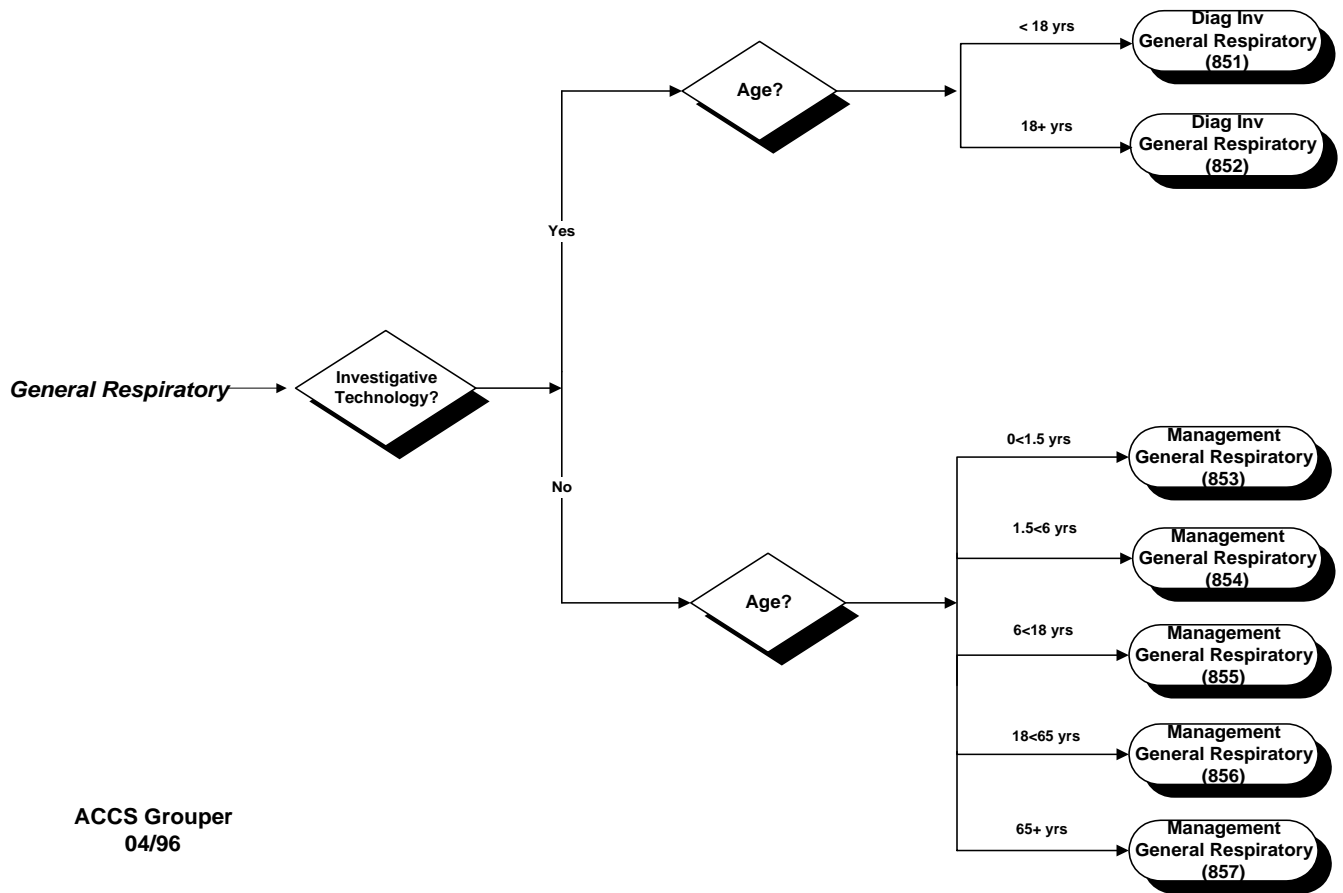

ACCS Grouper
04/96

Respiratory Clinical Grouping

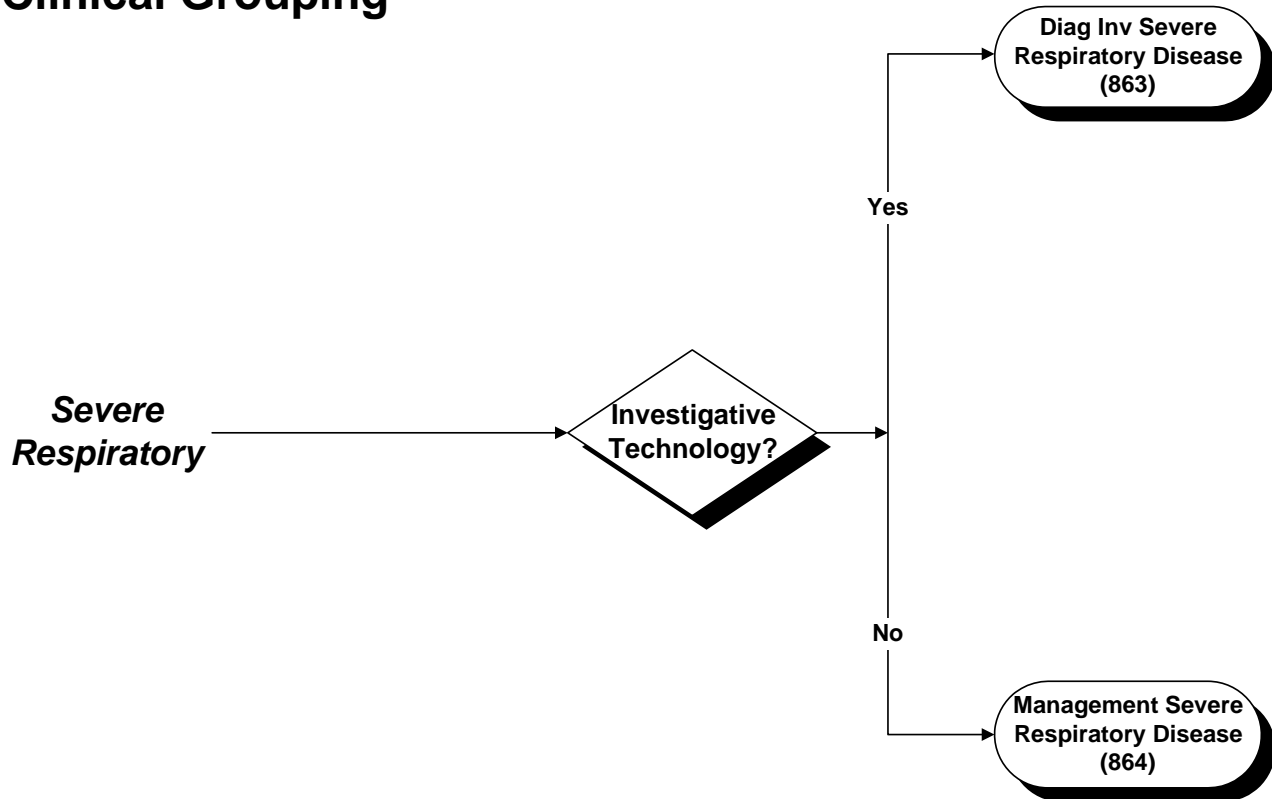

ACCS Grouper
04/96

Skin & Soft Tissue Clinical Grouping

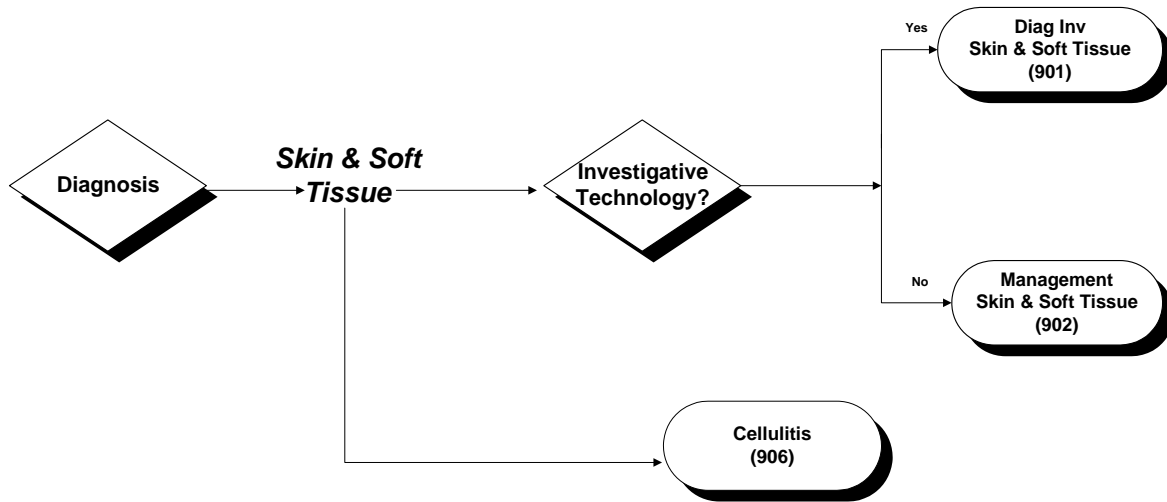

ACCS Grouper
04/00

Systemic Infection Clinical Grouping

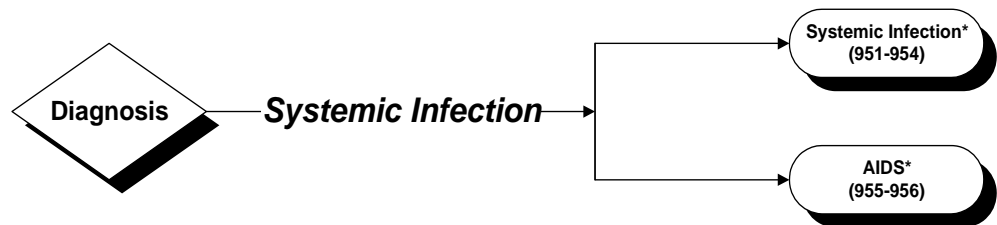

*Clinical Group broken down further -
see following pages.

ACCS Grouping
04/00

Systemic Infection Clinical Grouping

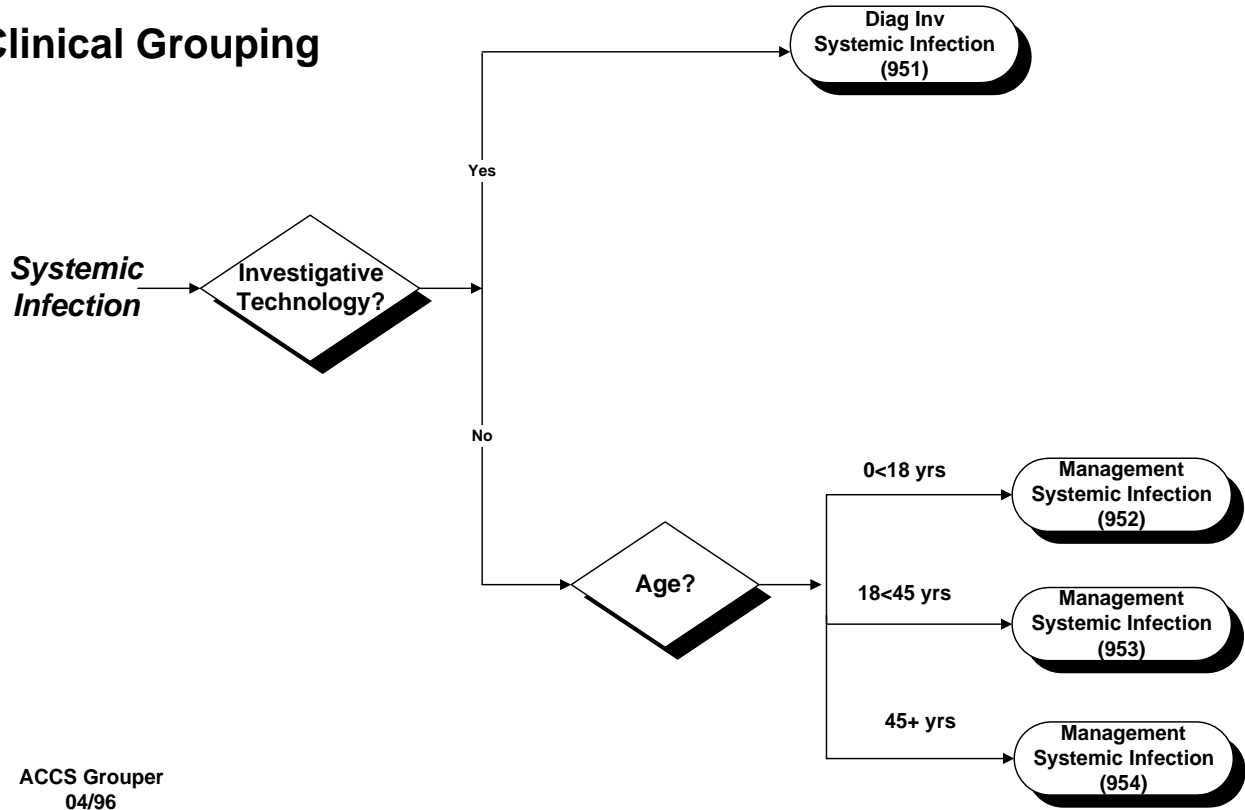

ACCS Grouper
04/96

Systemic Infection Clinical Grouping

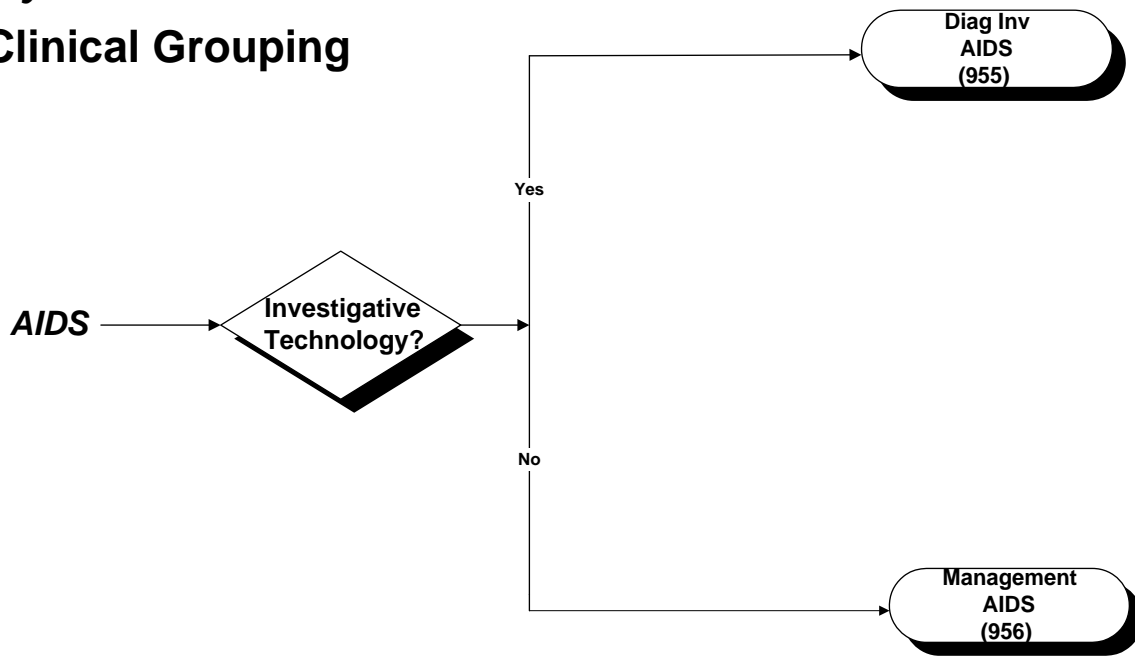

ACCS Grouper
04/00

Trauma Clinical Grouping

(continued on the next
page)



Trauma

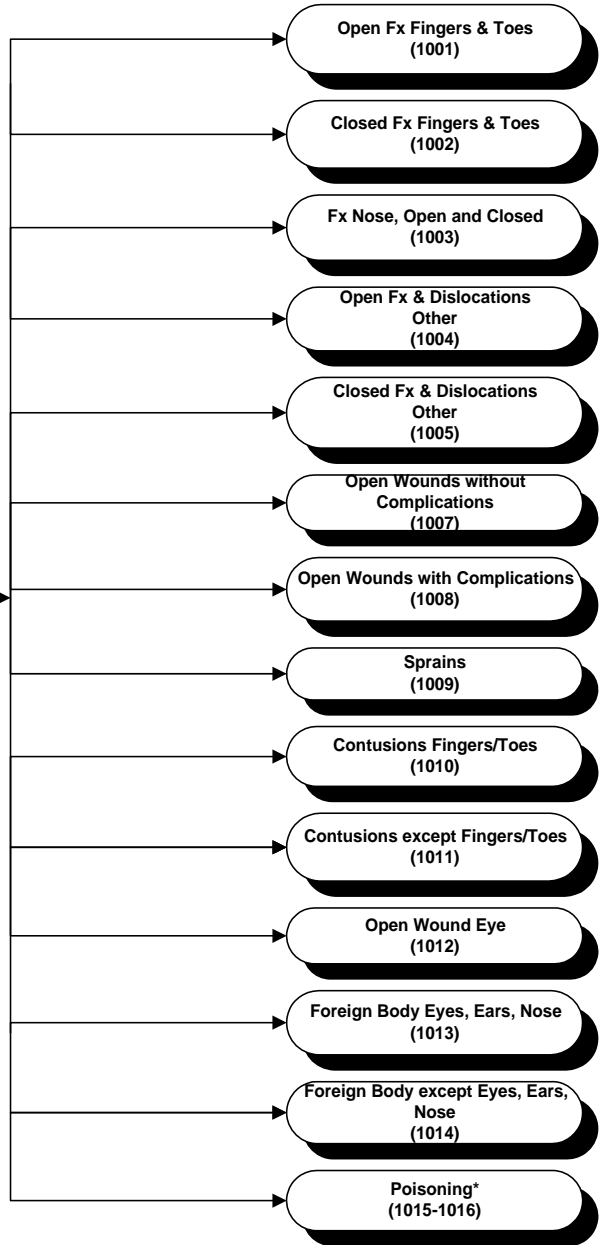

*Clinical Group broken down further - see following pages

ACCS Grouper
04/96

Trauma Clinical Grouping

(continued from the
previous page)



Trauma

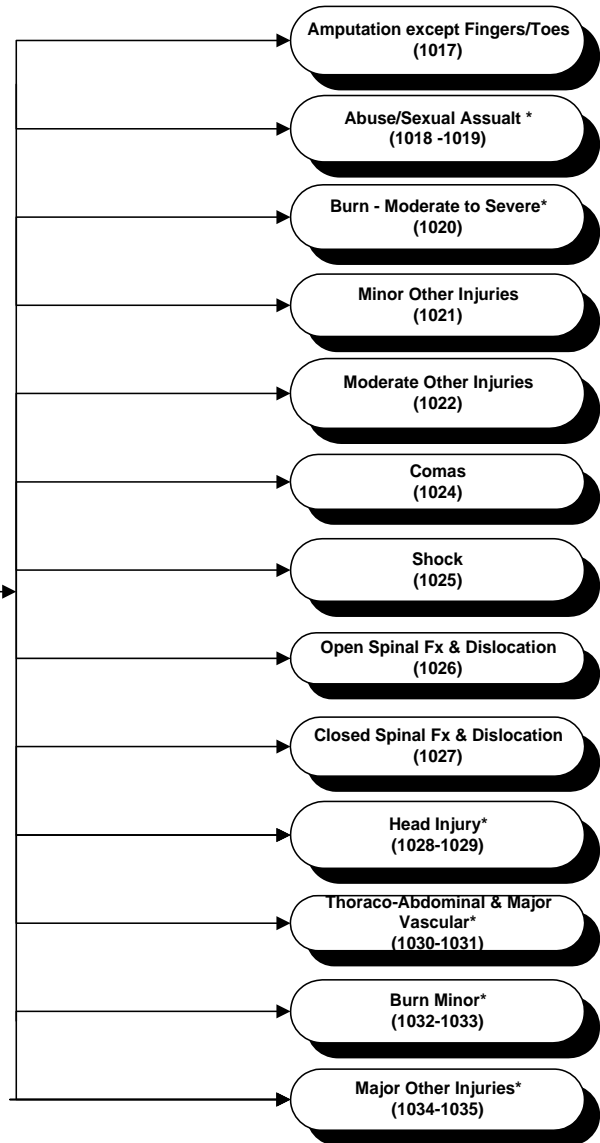

*Clinical Group broken down further - see following pages

ACCS Groupers
04/00

Trauma Clinical Grouping

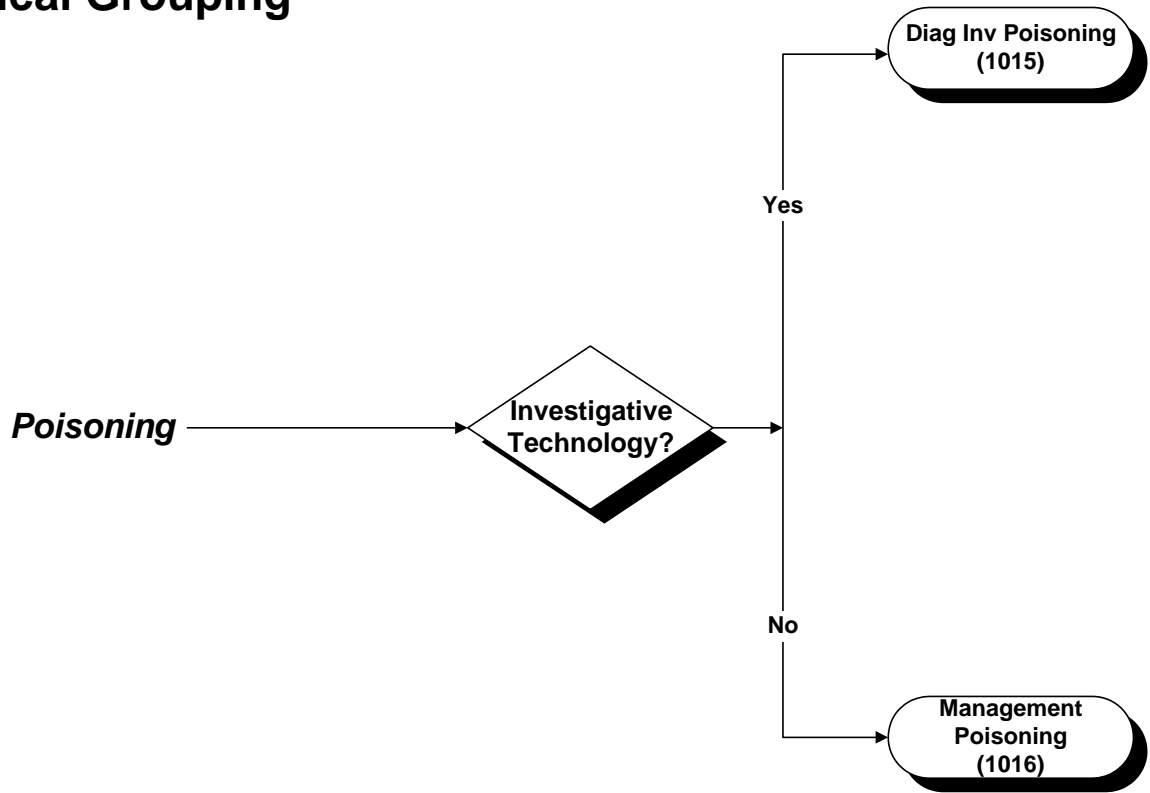

ACCS Groupers
04/96

Trauma Clinical Grouping

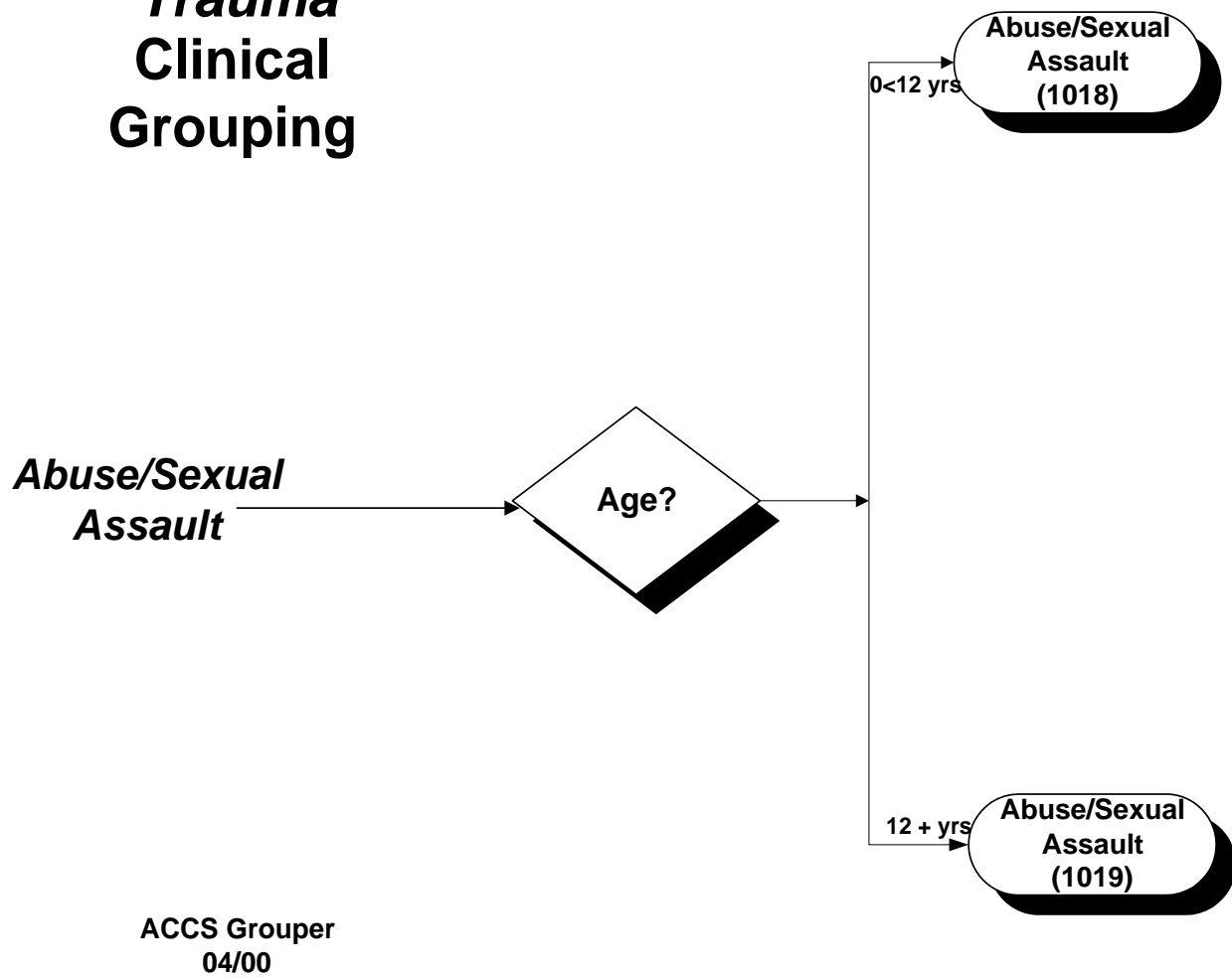

Trauma Clinical Grouping

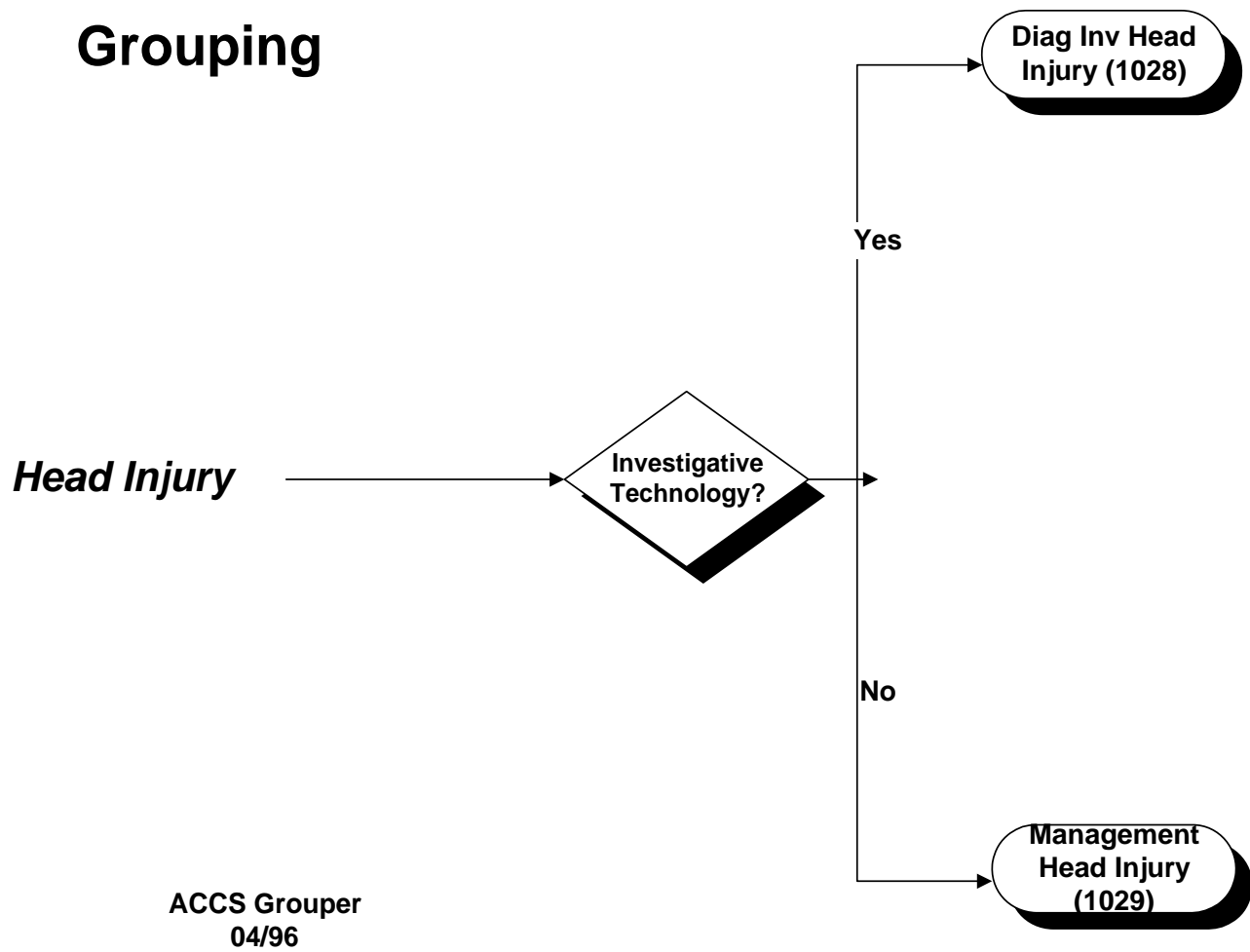

Trauma Clinical Grouping

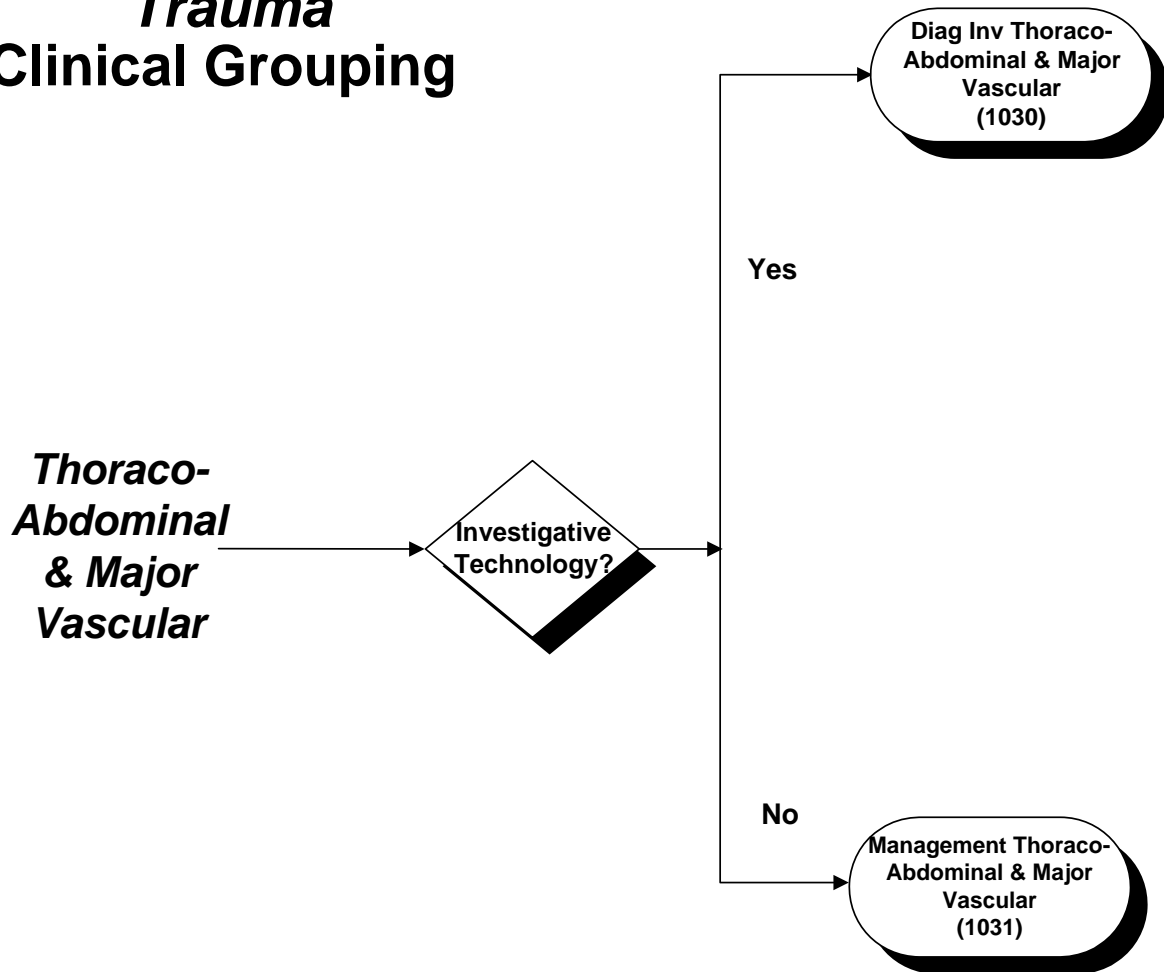

ACCS Grouper
04/96

Trauma Clinical Grouping

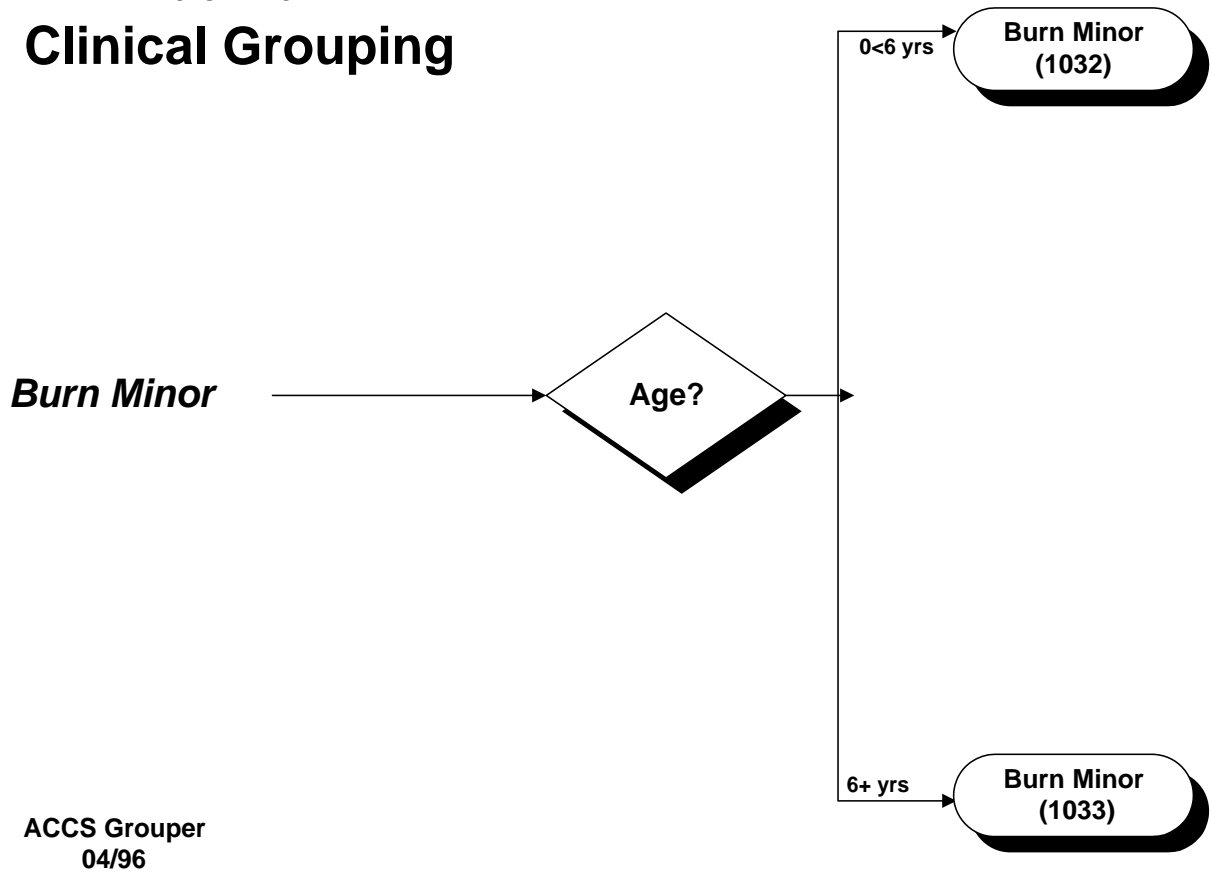

Trauma Clinical Grouping

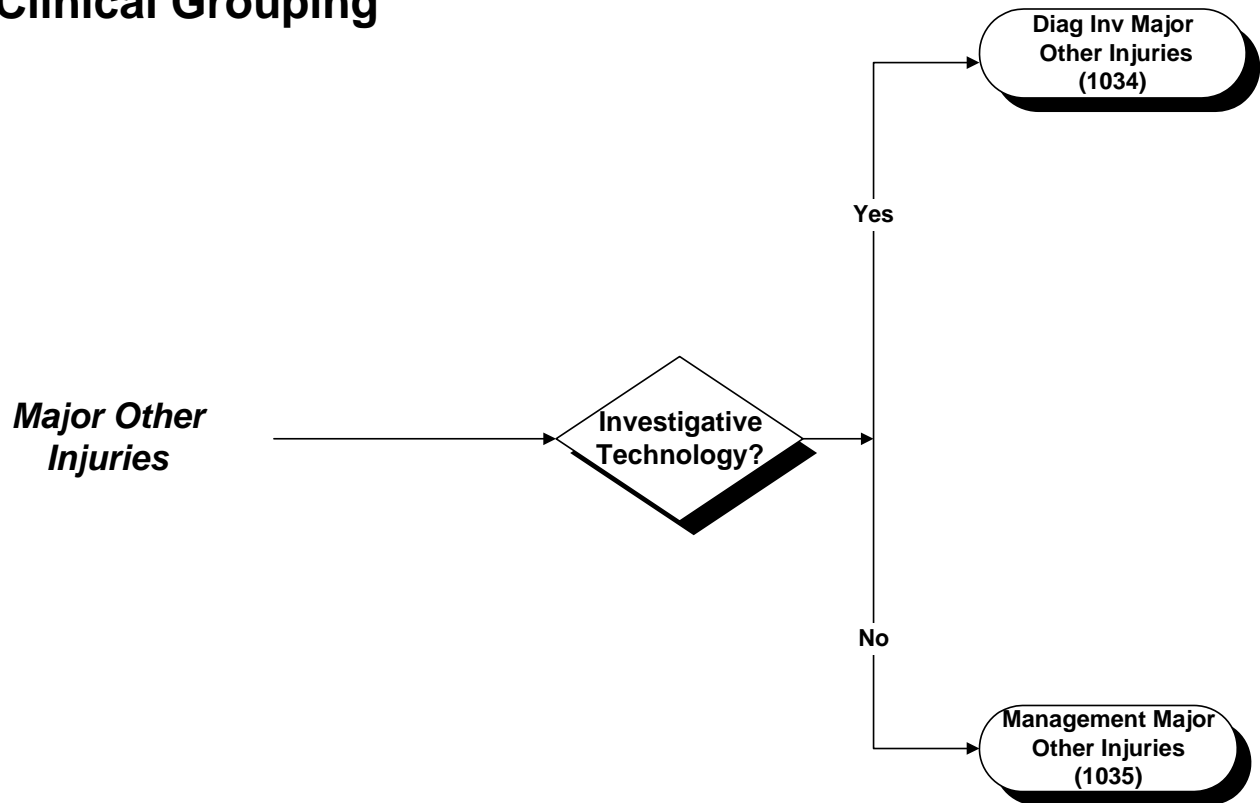

ACCS Groupers
04/96

Mental Health Clinical Grouping

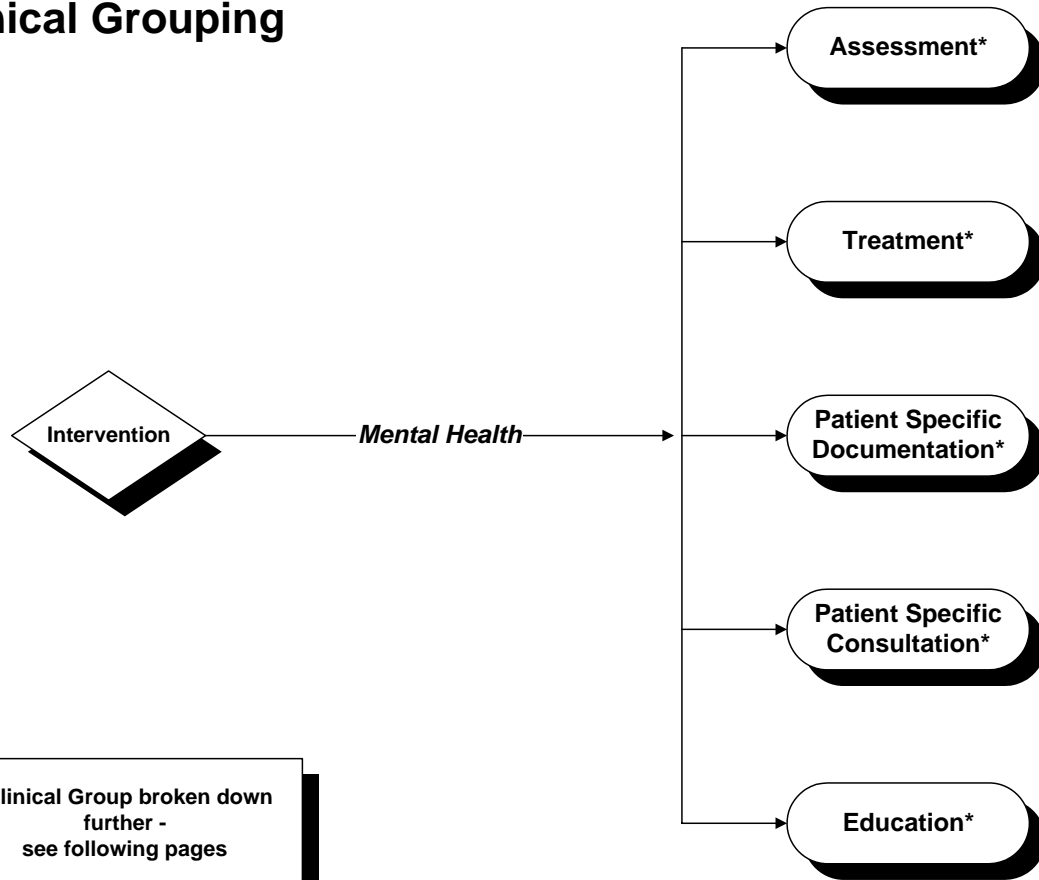

*Clinical Group broken down further - see following pages

ACCS Groupers
04/96

Mental Health Clinical Grouping

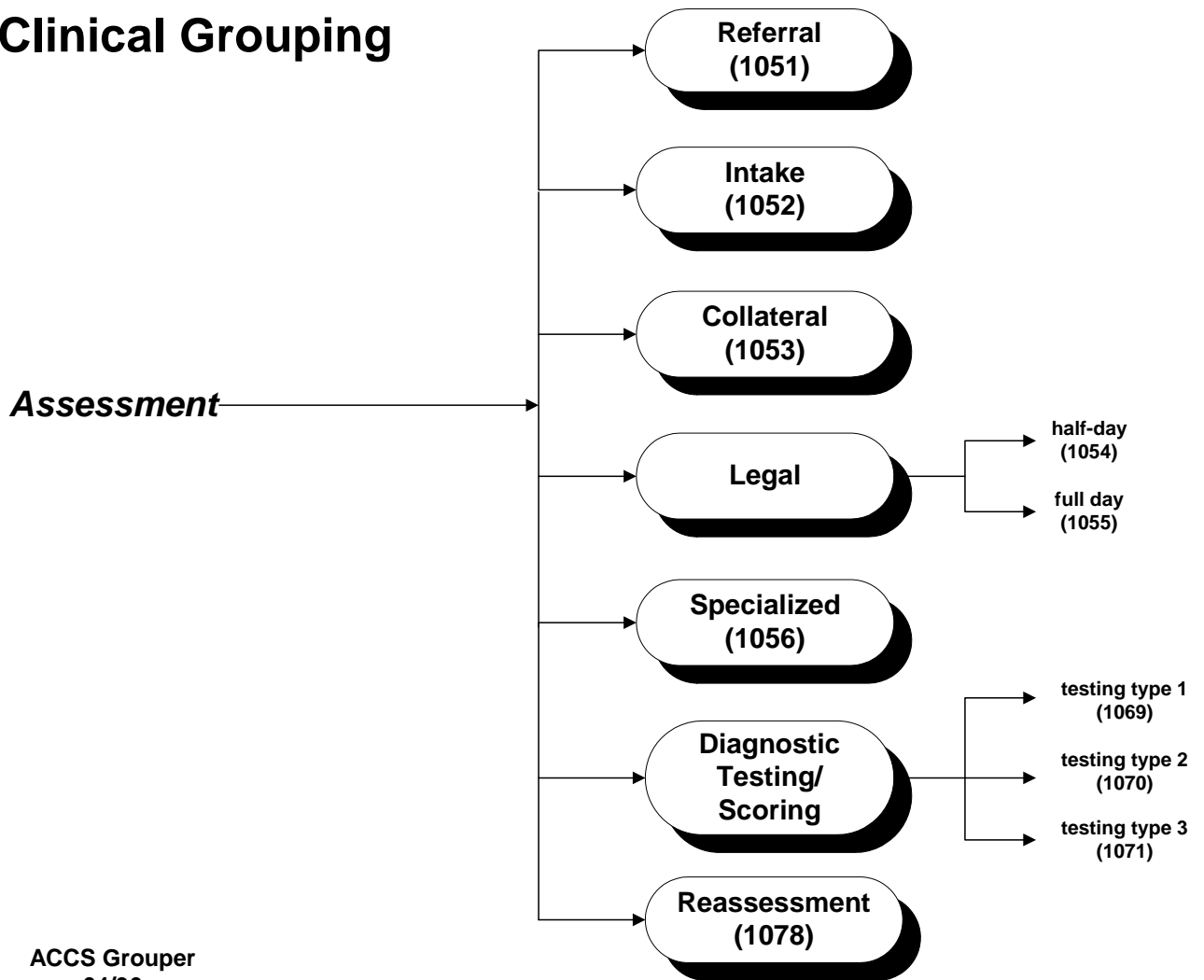

ACCS Grouper
04/96

Mental Health Clinical Grouping

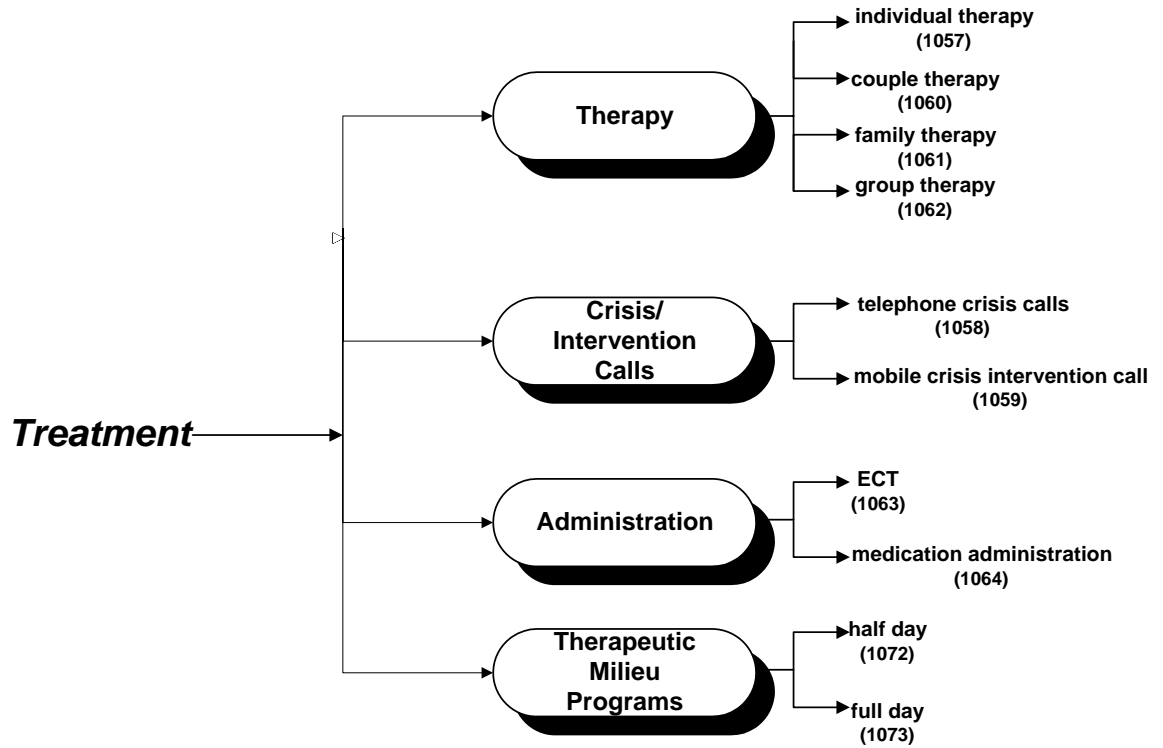

ACCS Grouper
04/96

Mental Health Clinical Grouping

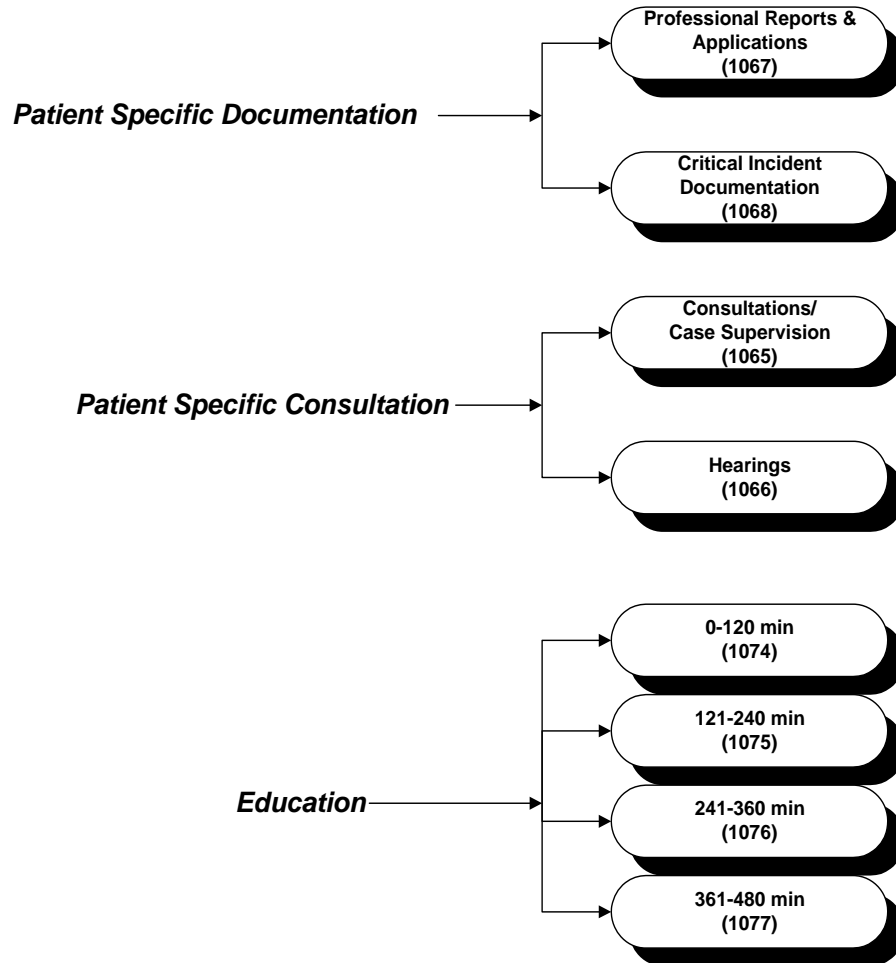

ACCS Grouper
04/96

Rehabilitation Clinical Grouping

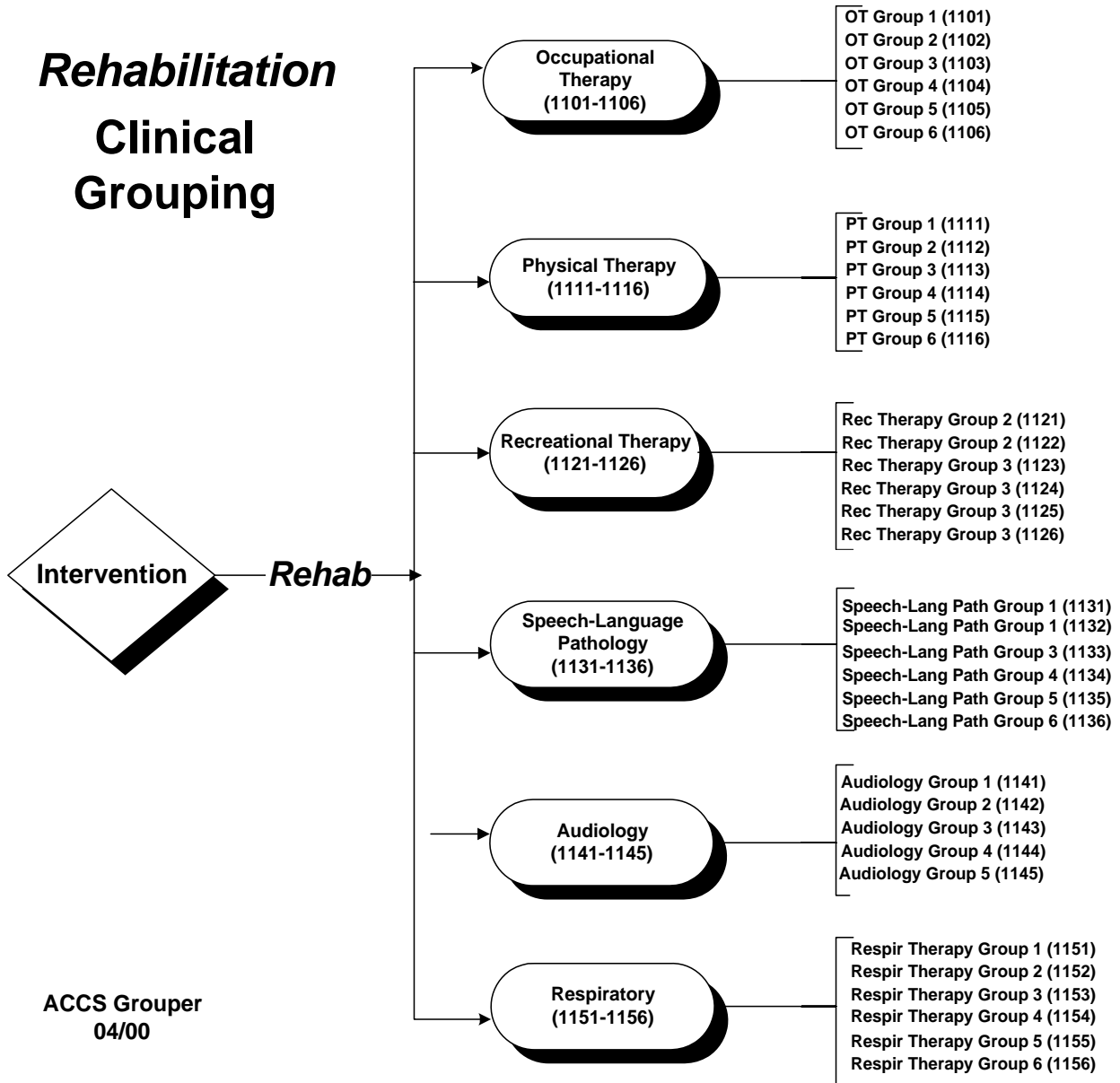

ACCS Grouper
04/00

Clinical Nutrition

Clinical Grouping



ACCS Grouper
04/98

Social Work

Clinical Grouping



ACCS Grouper
04/98

Psychology

(Rehabilitation)

Clinical Grouping

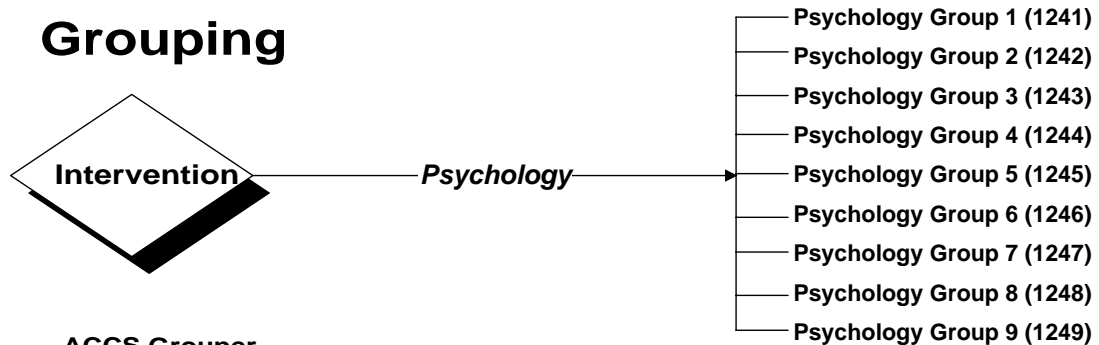

ACCS Grouper
04/98

Admitted Service Recipient Clinical Grouping

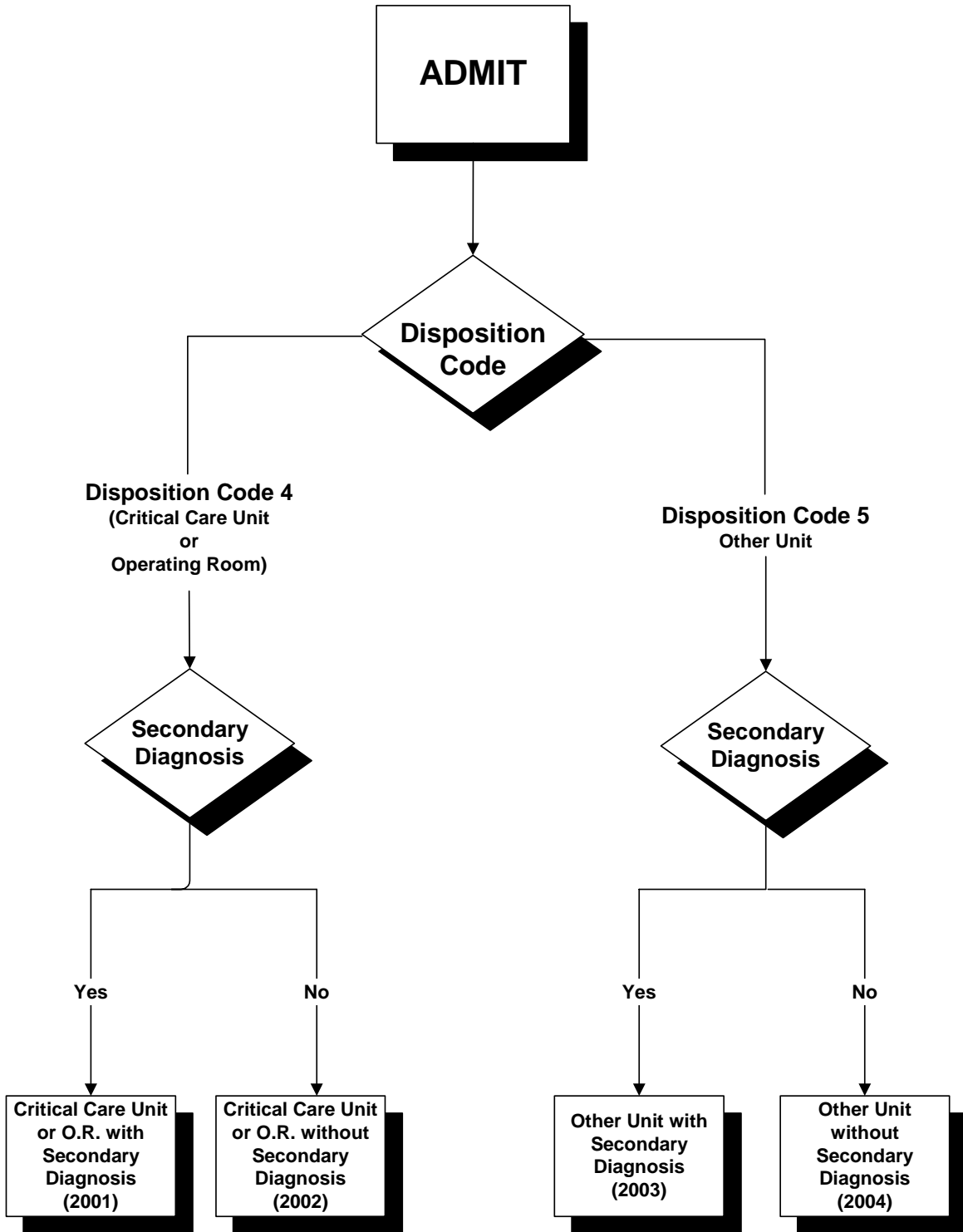

ACCS Groupers
04/96

Deceased Service Recipient Clinical Grouping

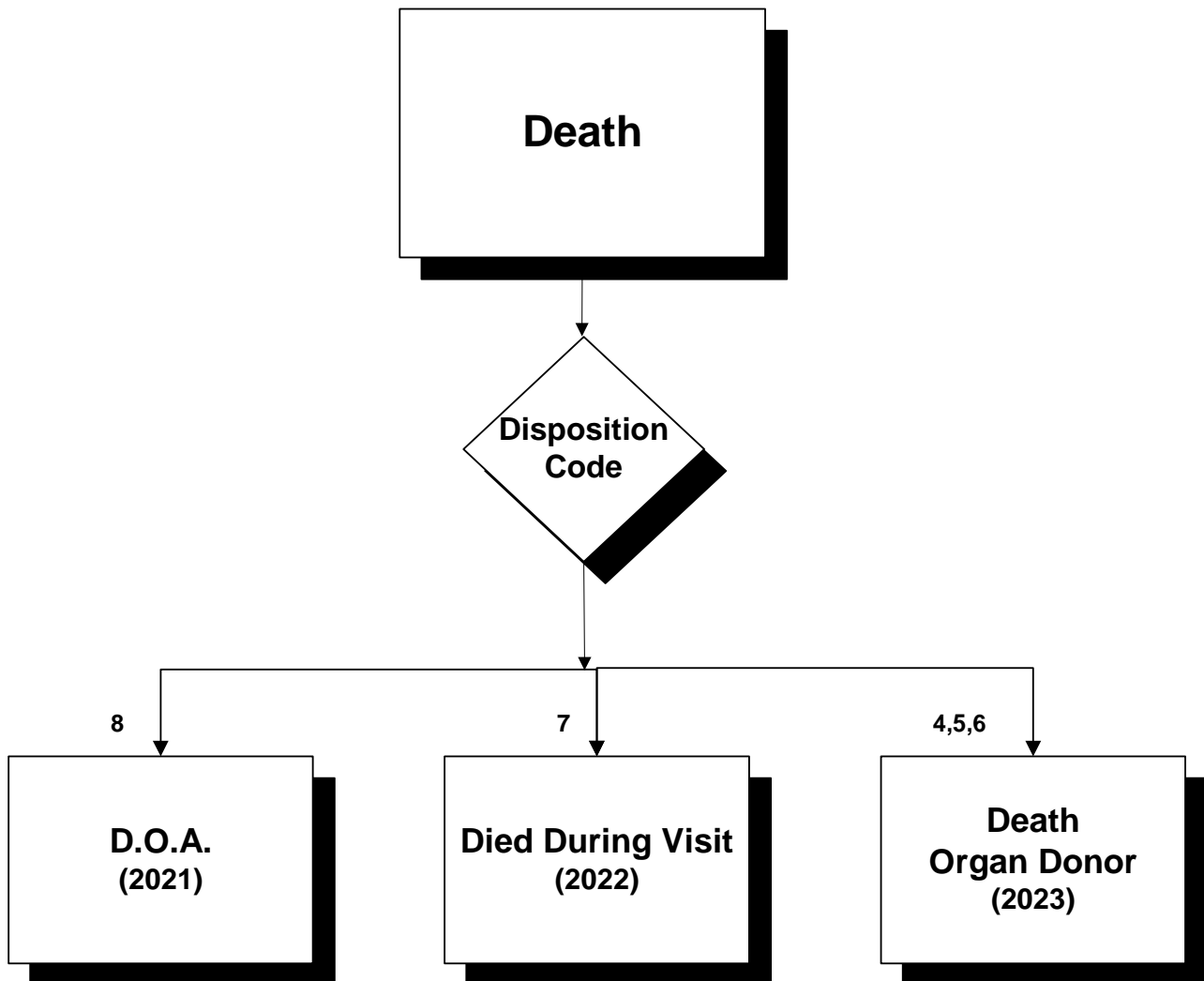

ACCS Grouper
04/00

Transferred Service Recipient Clinical Grouping

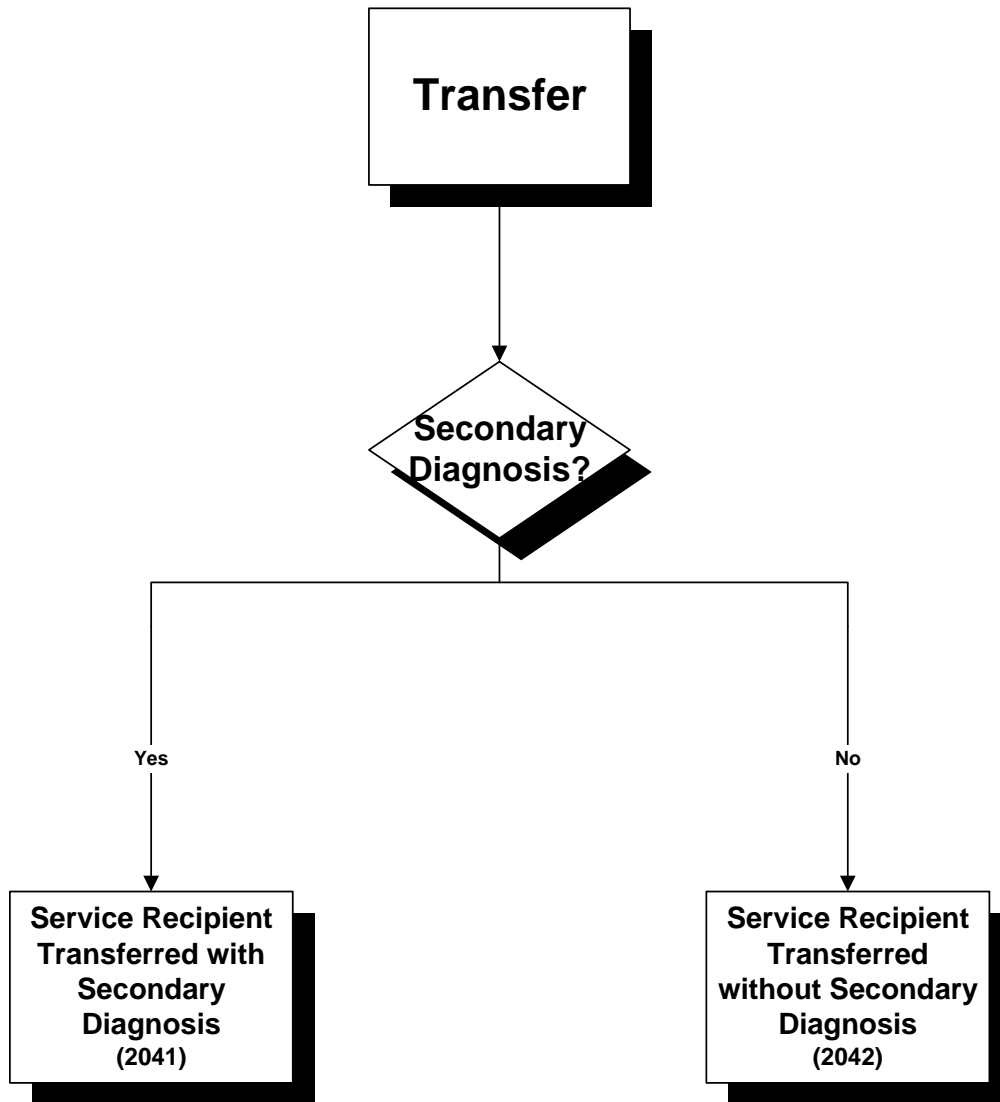

ACCS Grouper
04/96

Exam/Other Clinical Grouping

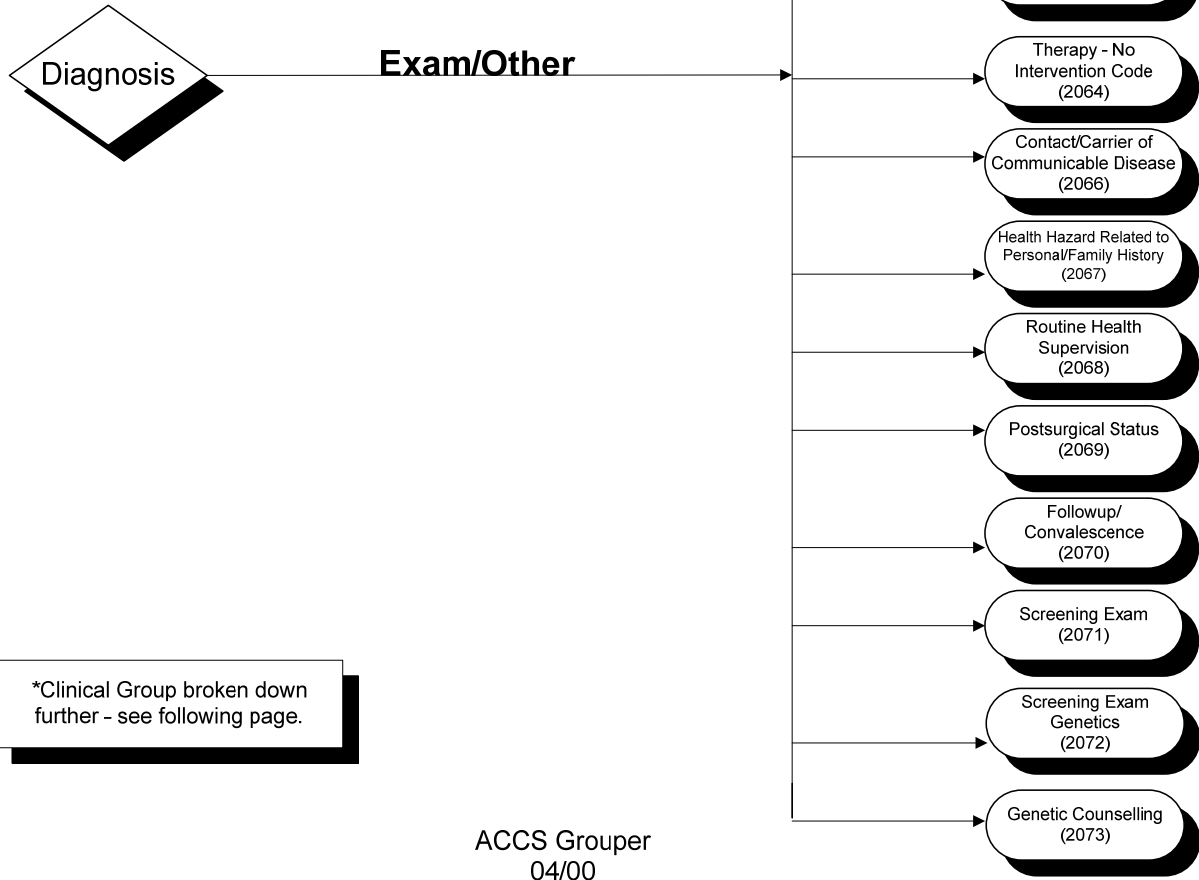

Exam/Other Clinical Grouping

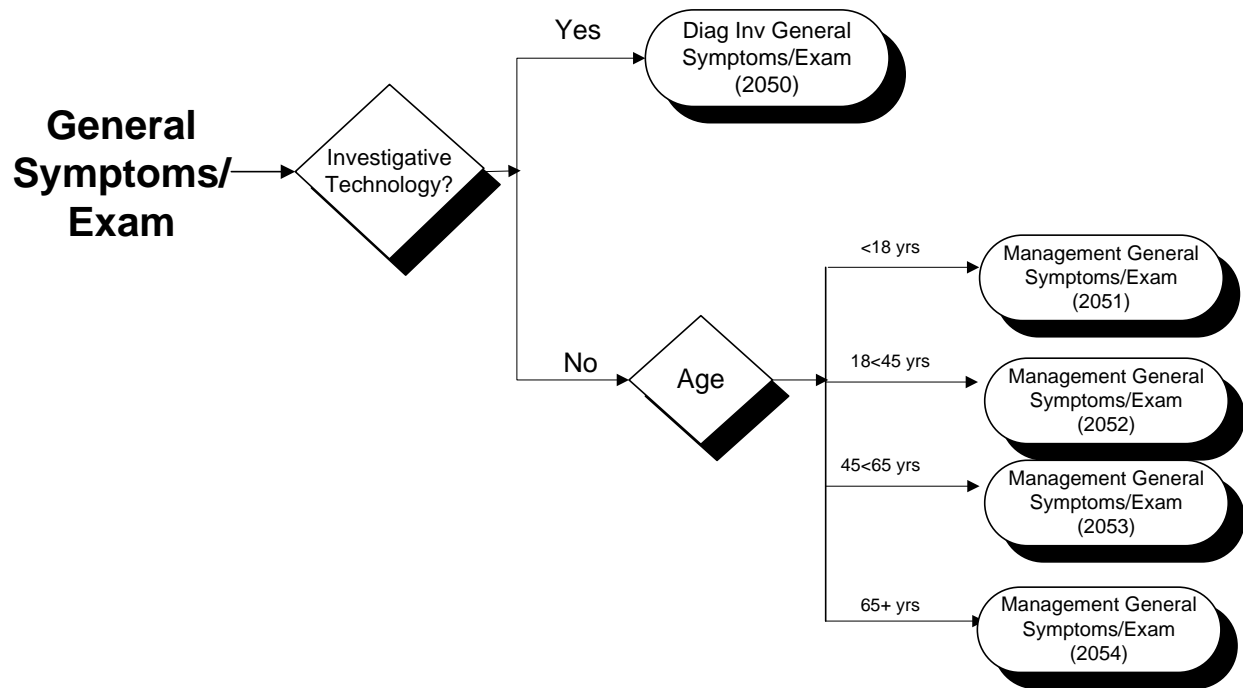

ACCS Groupers
04/00

Non-Registered Service Recipients Clinical Grouping



ACCS Grouper
04/98

Mode of Service Telephone Clinical Grouping



ACCS Grouper
04/00

Service Recipient Left Without Being Seen Clinical Grouping



ACCS Grouper
04/98