



MINIMIZING RISK AND LIABILITY

BEST PRACTICES GUIDE FOR TRAIL STEWARDS,
OPERATORS, MANAGERS AND OWNERS



ALBERTA TOURISM,
PARKS AND RECREATION
RECREATION SERVICES BRANCH

903, Standard Life Centre
10405 Jasper Avenue
Edmonton, AB
T5J 4R7

**Government
of Alberta** ■

ACKNOWLEDGEMENTS

Alberta Tourism, Parks and Recreation
Outdoor Development Branch

Alberta Trails Steering Committee
Alberta Tourism, Parks and Recreation
Alberta Environment and Sustainable Resources Development
Alberta Trail Net Society
Alberta Finance and Enterprise, Risk Management and Insurance Division

Consultants

MHPM Project Leaders
NORR Architects and Planners
Capris Insurance Services Ltd.
McLennan Ross Legal Counsel
Trail Crew Design Corp.

Photo Credits

Alpine Club of Edmonton
Alberta Environment and Sustainable Resource Development
Cal Rakach
Anne M. O'Dell
Rob Woito
Trail Crew Design Corp
Alberta Tourism, Parks and Recreation. Outdoor Development Branch

Disclaimer of Liability for Use of Documents

Anyone making use of this document is advised that the Government of Alberta disclaims liability for any claims, actions, demands or suits which may arise by reason of any person relying on the information contained in this document, and more particularly, without limiting the generality of the foregoing, the government disclaims liability for the appropriateness or accuracy of the guidelines, details or specifications for any project.

In plain language, this document provides you with a variety of best practices to minimizing risk and liability while designing, building and operating trails in Alberta. None of the drawings are intended for construction purposes.

ISBN Print #978-0-7785-5903-0
ISBN Online #978-0-7785-5904-7

TABLE OF CONTENTS

	-
EXECUTIVE SUMMARY.....	1
1.0 REGULATORY APPROVALS.....	2-3
2.0 RISK MANAGEMENT.....	4-6
3.0 BEST PRACTICES FOR INSURANCE COVERAGE.....	7
4.0 OPERATIONAL BEST PRACTICES.....	8-9
5.0 TRAIL PLANNING AND DESIGN.....	10-37
6.0 TRAIL CONSTRUCTION.....	38-46
7.0 TRAIL SIGNAGE.....	47-57
8.0 WATER CROSSINGS.....	58-61
9.0 TRAIL OPERATIONS.....	62-63
10.0 TRAIL VOLUNTEERS AND STEWARDSHIP.....	64-65
11.0 TRAIL MAINTENANCE.....	65
12.0 SPECIAL TRAILS.....	66-69
13.0 APPENDICES.....	70
APPENDIX A - SAMPLE VOLUNTEER APPLICATION FORM	
APPENDIX B - SAMPLE LIABILITY RELEASE FORM	
APPENDIX C - SAMPLE SAFETY POLICY	
APPENDIX D - SAMPLE SAFETY FACT SHEET	
APPENDIX E - SAMPLE TRAIL INSPECTION REPORT	
APPENDIX F - SAMPLE TRAIL INCIDENT REPORT	
APPENDIX G - SAMPLE TRAIL USE & INDEMNIFICATION AGREEMENT	
APPENDIX H - AVALANCHE SAFETY PLANS	
APPENDIX I - EXTREME TRAILS WAIVER POLICY AND FORMS	
APPENDIX J - EXTREME TRAILS INCIDENT REPORTING FORMS	
14.0 REFERENCES.....	81-82

EXECUTIVE SUMMARY

Trails are an important economic asset to the recreation and tourism industry of Alberta. Trails preserve critical open space, and provide important transportation options and connections to different areas in Alberta. Trails and their associated activities attract both visitors and locals to recreate in Alberta. Their economic potential as highly desirable destinations, facilitate job growth in the tourism and construction industries. Entrepreneurial opportunities like restaurants, lodging, gift shops, and other local specialty stores often get built alongside popular trails. Small towns and municipalities are realizing the economic importance of trails and are utilizing the development of trails as a model for community economic revitalization and rural diversification. As trail usage and trail development increases, there is a need to equip trail operators, managers and owners with the necessary tools to manage and minimize the risk and liability associated with trail operations. Creating a safer environment for everyone improves the economically feasibility for trail groups to operate these trails over the long term.

This document is a best practices manual intended to give guidance and direction on minimizing risk and liability for persons with an interest in operating and maintaining trails. Specifically, it seeks to help trail operators, managers and owners, mitigate risk and reduce liability, that can arise from trail design, trail use and maintenance operations. The techniques discussed here are intended to be applied with prudence and due consideration of the particular circumstances of each trail.

For the purposes of this document a Trail Operator/Manager/Owner is defined as a not-for-profit organization formed with an interest in the design, development, management and maintenance of multi-use and mixed used trails for a variety of recreational uses (i.e. cross-country skiing , cycling, equestrian, hiking, snowmobiling, off highway vehicles (OHV)). The trail operator/manager/owner must comply with all terms and conditions stipulated by the land governing authority, or land owner, for the right to build, perform maintenance and/or upkeep on the trail. In most jurisdictions the right to perform these activities does not imply ownership of the trail.

This document should be read in conjunction with the “Alberta Recreation Corridor and Trails Classification System” manual available from Alberta Tourism, Parks and Recreation. To obtain an electronic copy of this document, please visit the websites: www.trailnet.ca or www.tpr.alberta.ca.

The following definitions provide an understanding of how Alberta has classified its trail network and indicates the differences between the mixed use and multi-use trail classifications. For more detail, please refer to the “Alberta Recreation Corridor and Trails Classification System” manual.

Multi-Use trails are divided into the following general categories: Non-Motorized and Motorized trails.

Multi-use non-motorized trails are defined as any trail that is built, managed and operated for use by more than one type of non-motorized user.

Multi-use motorized trails are defined as any trail that is built, managed and operated for use by more than one type of motorized user.

Mixed use trails are defined as any trail that is built, managed and operated to include both motorized and non-motorized uses on the same trail. An extensive number of user combinations are possible and the trail use will be determined by the group with the authority to designate the type of trail; (such as the owner/manager of the land –typically in consultation with other stakeholders). The user group with the highest level of design requirements (widest trail, largest clear zone, and most gentle gradients) will determine the overall design characteristics for the trail.

Motorized Vehicles: For the purposes of this document, motorized trail users are defined in the Traffic Safety Act as any user that operates an ‘ Off Highway Vehicle’ (OHV). OHV’s include the following vehicles : All Terrain Vehicle (ATV), Off Road Vehicle (ORV), Off Road Motorcycle (ORM) and Snowmobiles.

1.0 REGULATORY APPROVALS

Every Trail Operator/Manager/Owner that is considering opening a new trail or performing maintenance on an existing trail should first seek approval from the land owner. If this land is not owned privately, then seek approval from the governing authority of the land the trail is located on, (except in cases where long term agreements that guides those processes are already in place). These authorities will usually be able to assist trail Operators/Managers/Owners in determining other stakeholders or common interest groups that may have other vested interests in the land. It is the responsibility of the Trail Operator/Manager/Owner to ensure they have the proper permissions, as well as a common understanding between the land owners and themselves about their rights and limitations to the land before commencing construction or maintenance. Trail Operators/Managers/Owners will need to respect the regulatory approval processes required to get a trail approved for use.

For trails that are located within municipal property they should contact the municipal planning office which will have a development approval process that may require drawings and a description of the purpose of the trail. Typically this approval process will run from 2-4 months depending on the municipality and may require a zoning change.

For trails that are located within the jurisdiction of Federal Parks, new trail construction is only carried out under the direction and guidance by Parks Canada itself.

For trails on Provincial Crown land, most trails are under the jurisdiction of Sustainable Resource Development. Trail Operators/Managers/Owners should understand that establishing and maintaining trails on Alberta's public land may require:

- 1) A land use decision authorizing and registering the trail location, route and purpose. Depending on area suitability and the degree of existing activity in an area (e.g. forestry, commercial

activity, industry), trail proponents should be prepared to invest considerable time and effort into planning, preparation, and consultation in the development of trail proposals for consideration,

- 2) Authorization to perform construction or maintenance work according to specific standards.
- 3) Individual volunteers who volunteer directly with the Department must be registered with the Department and meet worker competency requirements prior to the commencement of authorized work.
- 4) Volunteer organizations must be registered with the Department and meet requirements related to insurance and worker competency prior to the commencement of authorized work.
- 5) Trail proponents to enter into agreements with the Province of Alberta pertaining to ongoing ownership, liability and responsibility for associated trail infrastructure.

The following is useful contact information for Trail Operators/Managers/Owners.

1. On land under the mandate of Tourism, Parks and Recreation, Parks Division, contact:
Alberta Tourism, Parks and Recreation
Parks Division
Policy & Land Use Planning
2nd floor, Oxbridge Place
9820-106 Street
Edmonton, Alberta T5K 2J6
Tel: 780-427-3582 (toll-free 1-866-427-3582)

2. On land under the mandate of Environment and Sustainable Resource Development, contact :
Alberta Environment and Sustainable Resource Development
Main Floor, Great West Life Building
9920 108 Street
Edmonton Alberta Canada T5K 2M4
Tel: 780 944-0313, (toll free: 1 877 944-0313)
Fax: 780 427-4407
Email: srd.infocent@gov.ab.ca

3. On land under the mandate of Transportation, contact:
Government of Alberta Transportation Department
Policy and Corporate Services Division
Strategic Policy Branch
3rd Floor Twin Attria Building
4999-98 Avenue
Edmonton, Alberta Canada, T6B 2X3
Tel: 780-427-2731, (toll free: 310-0000)

It is important to note that the Transportation Department does not encourage the development of trails in highway rights of way. However Transportation may consider allowing some portion of a trail to be on highway land to alleviate specific operational safety concerns or to allow a trail to continue in its general planned direction. An application would have to be submitted “for all proposed developments, including change in use of existing development or access, within 300 meters of the provincial highway right-of-way boundary or within 800 meters of the centre point of an intersection of the provincial highway with another public road.”

4. On land under the mandate of Alberta Environment, contact information can be found at this website www.environment.alberta.ca

5. On land under the mandate of Culture and Community Spirit

A Trail Operator/Manager/Owner who undertakes developing a new trail may encounter a historic or archaeological site or be planning to develop a trail where these sites are known to exist. It is recommended that Trail Operators/Managers/Owners determine in advance of construction whether a proposed trail will intercept or disturb a significant historic resource. The list of Historic Resources can be found on the Alberta Culture and Community Spirit website -> Heritage and Museums tab -> Historic Resources Management -> Land Use Planning which is presently at <http://culture.alberta.ca/heritage/resourcemanagement/landuseplanning/default.aspx>.

6. On land under the mandate of Department of Fisheries and Oceans, contact:
Fisheries & Oceans Canada
Alberta District
4253-97th Street, Edmonton, AB, T6E 5Y7
Tel: 780-495-4220

A Trail Operator/Manage/Owner that is considering work within a water body must request the permission from the Department of Fisheries and Oceans prior to commencement of work.

For more information regarding planning or building a trail or supporting trail development, one can also contact ‘Alberta TrailNet’. Please visit the website www.trailnet.ca for details.

2.0 RISK MANAGEMENT

Many different risks can be encountered while carrying out a recreational trail activity. If it is within the Trail Operators/ Managers/ Owners scope of agreement with the land authority or land owner, that their involvement extend into maintenance and management of a trail, then they have a responsibility to provide a reasonable “duty of care” that contributes to the safety of trail users. This is a duty requiring the Operator/ Manager/ Owner to take active steps not just to build a safe trail, but to inspect and maintain it, so that dangerous conditions are identified and corrected. Trail Operators/Managers/Owners should be aware that anyone can bring a civil case against them, for damages incurred while using a trail that is managed, maintained or owned by them.

The following is current legislation that is relevant to Trail Operators/Managers/ Owners:

2.1 THE OCCUPIERS’ LIABILITY ACT

The Occupier’s Liability Act (“OLA”) came into force in Alberta in 1974. Occupier’s liability is the area of tort law concerned with the responsibilities of occupiers of property to individuals who are injured on their property.

An occupier is defined in the statute as anyone who owns the property, or who has responsibility and control over the condition or activities conducted on the premises. Depending on agreements in place between the land Authority/ Owner and the Trail Operator/Manager/Owner, the Trail Operator/Manager/Owner may be considered an occupier on the land. Therefore, it is important for them to understand what they can be liable for under the OLA.

Under the OLA, the occupier has the following ‘Duty of Care’ to a person who uses the premises for recreational purpose (By definition: These ‘persons’ are termed “trespassers” in the OLA):

“An occupier is liable to trespassers for damages, for death or injury to the user that result from the occupier’s wilful or reckless conduct.”

“Wilful” conduct requires a deliberate act intended to cause injury and “Reckless” conduct would imply gross negligence. This generally means that the ‘occupier’ can be held liable if their conduct shows an indifference to the safety of a trespasser.”

The OLA does create a higher duty of care for occupiers in relation to children trespassers. A higher duty of care is owed to children trespassers because children are often less perceptive of the dangers which may exist on the premises or are less able to make reasonable choices to avoid those dangers.

For these reasons, it is in the Trail Operator/Manager/Owner(s) best interest to operate on the basis of a heightened duty of care. This document offers strategies to the trail operator to effectively provide this heightened duty of care thus reducing their exposure to liability.

2.2 THE FOREST AND PRAIRIE PROTECTION ACT

The Forest and Prairie Protection Act, R.S.A. 2000, c. F-19 prohibits any person from lighting or causing to be lit, an outdoor fire unless that person is the holder of a subsisting fire permit (s.18(1)).

Trail Operators/Mangers/Owners need to recognize that they can be held liable to damage which occurs as a result of a fire caused by a trail user, unless they can prove that the trail user did not have consent to ignite the fire. A trail operator or owner may be tasked with locating the trail user in an effort to absolve him or herself from liability under the Act. However, best practices in terms of using proper signage to communicate with trail users that fires are prohibited or confined to restricted areas will assist a trail operator or owner in establishing that a fire was ignited without their consent.

2.3 THE PETTY TRESPASS ACT AND TRESPASS TO PREMISES ACT

The Petty Trespass Act (R.S.A. 2000, 2000) and Trespass to Premises Act (R.S.A. 2000 c. T-7, 2000) gives private land owners greater control over entry to and use of their premises. These Acts clearly state the situations where trespass will arise and sets out the punishment (a monetary fine) that a court can impose upon the trespasser. The scheme of these acts recognizes the cooperation between rural land owners and recreational trail associations. The retention of existing recreational trails and development of new trails depend on the responsible behaviour of the trail users and respect for land and its occupants.

Trail Operators/Managers/Owners need to recognize that trail users and their pets who wander beyond trail boundaries onto private land are considered trespassers and can be fined, and charges laid on them by bylaw officers. Providing proper signage to communicate this to trail users will reduce the number of negative run-ins with the law.

2.4 RISK MANAGEMENT APPROACH

Risk management is used by Trail Operators/Managers/Owners to assess risk, make decisions and implement appropriate risk controls. A Proper risk management program reduces risk by reducing the likelihood and/or severity of mishap occurring. It also allows the Trail Operators/Managers/Owners to find methods to transfer the risk where possible and know what risks they may have to retain. If the Trail Operator/Manager/Owner is not prepared to retain or accept the risk associated with certain activities then they may choose to eliminate or avoid that risk completely. The following are the basic steps one should employ for proper risk management:

- Identify potential exposures to loss
- Evaluate the risk
- Examine the options
- Determine the favored option
- Implement the chosen option
- Monitor results

As a trail grows in size, types and numbers of users it is designed to accommodate, the probability of inter-user conflict increases. For this reason Trail Operators/Managers/Owners engaged in complex trail usage, or whose involvement extends to more complex operations associated with trail management, will need to recognize that this also adds an additional burden of liability on them. Proper risk management can significantly improve the safety of trail users and decrease liability for the Trail Operator/Manager/Owner.

The following are some examples of risk management strategies a Trail Operator/Manager/Owner should consider to reduce their risk:

a. Avoidance – When planning the routing of any trail, a Trail Operator/Manager/Owner can reduce their risk by not routing a trail within areas of significant risk such as in avalanche zones. Trail Operators/Managers/Owners can also reduce their risk by temporarily rerouting or closing existing trails where a significant risk is determined, such as during poor weather conditions.

b. Transfer –Trail Operator/Manager/Owner can transfer risk to another party through the use of waivers or by obtaining proper insurance. Section 3 of this document covers the types of insurance coverage available for Trail Operators/Managers/Owners.

c. Retention – Retained risk is any risk the Trail Operator/Manager/Owner cannot avoid or transfer and so they must be prepared to assume on their own. The following are examples of retained risk:

- Small risks where the cost of insurance against the risk would be greater than the total losses over time.
- Catastrophic risk that cannot be insured against or the premiums would be unfeasible for the organization to carry on an on-going basis.
- Any amounts of potential risk over the amount insured.
- Insurance policy deductibles
- Claims that may be excluded from insurance coverage

Retention of risk may be acceptable to the Trail Operator/Manager/Owner if the chance of a very large loss occurring is relatively small or if the cost to insure against the risk is cost prohibitive.

The Trail Operator/Manager/Owner should be aware of the level of severity and the frequency of the retained risks that they are willing, or have no choice, but to accept. It is important that the Trail Operator/Manager/Owner have the budget and resources available to be able to withstand the financial implication of retaining risks.

d. Reduction – The Trail Operator/Manager/Owner can employ measures so that the likelihood and/or severity of the risk is reduced to such a level that they are able to manageably retain the risk by accepting the nominal probability of its occurrence. The following are strategies a Trail Operator/Manager/Owner should employ to reduce the level of known risks.

- Limiting the number and or type of trail uses suitable to the type of trail constructed and the environment it is located in;
- Proper trail routing taking into consideration acceptable slope gradients and minimizing erosion;
- Adequate tread surface, with appropriate vertical and horizontal clearances;
- Proper communication to trail users through the use of clear signage;
- Regular maintenance and monitoring of physical conditions affecting the trail, such as weather, land slides, rock falls and avalanche hazards;
- Screening volunteers for appropriate levels of knowledge and prudence;
- Checking motor vehicle records for all employees and volunteers driving on the non-profit's behalf;
- Developing board orientation and volunteer training materials;
- Coordinating the development and consistent use of employment practices;
- Complaint Management – normally, verbal or written complaints are the first hints that risks exist and identifies potential for lawsuits to occur. Good complaint management means recording complaints and complaint history and developing a corrective action process that resolves the original complaint and prevents its re-occurrence in future;
- Training volunteer staff and using engineered structures are effective risk reduction strategies;

Useful risk management information is available at the following web sites:

- www.abc.ca
- www.volunteeralberta.ab.ca
- www.ourcommunity.com.au
- nonprofitrisk.imaginecanada.ca

3.0 TYPE OF AVAILABLE INSURANCE COVERAGE

In Canada, liability of the Trail Operator/Manager/Owner is governed by both common (TORT) law and legislation. In this instance, TORT law applies to a trail volunteer, visitor, trespasser or even adjacent landowner that may bring a civil case against the Trail Operator/Manager/Owner(s) for damages incurred as a result of an incident on the Trail that the trail group operates. Insurance coverage is an effective way to limit a Trail Operator/Manager/Owner(s) exposure and liability to potential litigious situations. Insurance is one of the first things a Trail Operator/ Manager/Owner should set up as part of their organization and management structure prior to planning and designing a trail.

In most instances, the land manager/owner will have minimum insurance coverage requirements that Trail Operator/Manager/Owner(s) are required to carry before the land owner/manager will allow any work be done on their land. Please contact the appropriate authorities and find out what minimum insurance is required to commence any work.

The following related types of insurance are available for use by Not for Profit Trail Operator/Manager/Owner(s)

3.1 PERSONAL LIABILITY COVERAGE POLICIES:

1. Commercial General Liability (CGL) - this includes:
 - Bodily Injury and Property Damage Liability
 - Personal Injury Liability
 - Medical Payments
2. Directors and Officers Liability
3. Employment Practices Liability
4. Umbrella Liability or Excess Liability

3.2 PROPERTY COVERAGE POLICIES:

1. Property Coverage for Clubhouses, Offices
2. Liquor Liability
3. Special Events Liability
3. Tenants' Legal Liability
4. Crime Coverage
5. Product of Completed Operations (PCO) Liability
6. Forest Fighting Expense Coverage
7. Automotive Liability

3.3 THIRD PARTY COVERAGE POLICIES:

1. Professional Liability
2. Employer's Liability
3. Abuse Liability
4. Environmental Liability

As a best practice, Trail Operators/Managers/Owners are advised to consult an insurance agent/ insurance broker/ insurance lawyer to obtain advice on the necessary coverage one might need to protect their organization against any claims.

4.0 OPERATIONAL BEST PRACTICES

The most effective way for Trail Operator/Manager/Owners to limit their exposure and liability is to be proactive rather than reactive. While preventative efforts will not always eliminate or protect against liability, they will reduce the potential for accidents and limit exposure. The following is a list of best practices Trail Operators/Managers/Owners should consider before deciding upon a route and constructing a trail:

4.1 IDENTIFY TRAIL USERS:

- Determine likely activities.
- Determine likely age distribution of users – in particular, consider the potential for unaccompanied children, as children will require greater protection and direction to minimize risks.
- Determine if special needs individuals will be amongst the users – visual, auditory and physical impairments may require special consideration in the design of the trail.

4.2 IDENTIFY USER REQUIREMENTS:

- Determine suitable trail surface requirements.
- Determine appropriate gradients for trails, including desired maximum and minimum slopes.
- Determine potential conflicts between users groups and consider methods of mitigating this conflict.
- Determine appropriate construction standards for trails – for example, will maintenance vehicles require access.
- Provide sufficient area at trail heads to accommodate emergency vehicles and determine whether emergency access will be required along the entire length of the trail or at key locations.
- Where proposed activities have significant risk, consideration should be given to direct supervision of the activity and to screening of participants.

4.3 IDENTIFY AND MITIGATE HAZARDOUS CONDITIONS

- Avoid routing trails through high risk areas such as steep inclines, cliff edges and wet or unstable ground.
- Where permitted, build bridges to eliminate hazards such as gully crossings, and build retaining structures to stabilize trail edges.
- Where permitted by the land owner provide barriers and signage to direct users away from hazardous conditions adjacent to the trail.
- Provide a procedure for responding to hazards such as trail failure, flooding, landslides, wind storms and fire.
- Identify seasonal hazards and close trails during periods when such hazards occur. (Spring snow melt, blow downs and field spraying are examples of such periods.)

4.4 SIGNAGE AND WAY-FINDING:

- Provide adequate signage to mark trail heads identify the route of the trail.
- Provide a sign at the trail head identifying which uses are and which are not permitted on the trail.
- Provide a sign at the trail head identifying hazards inherent in the use of the trail.
- Provide a sign at the trail head outlining appropriate trail etiquette.
- Provide a notice board at the trail head where bulletins and alerts can be posted.
- Provide trail markers to identify the alignment of the trail and prevent users from becoming lost.
- Where practical, combine signs
- WHERE SIGNS ARE NOT PERMITTED - Trail Operator/Manager/Owners should find alternate means of providing the information listed above either through publications, web sites or guides readily available to the users.

4.5 OPERATIONAL ISSUES

- Establish a maintenance program with systematic record keeping and review maintenance activities to identify and correct deficiencies.
- Train volunteers and staff to provide appropriate levels of service including appropriate trail use and safety procedures.
- Establish emergency response protocols for all likely events and establish a trail patrol where necessary.
- Establish a procedure for recording and responding to accidents, complaints and incidents on the trail.
- Purchase and maintain insurance coverage as discussed in sections 2.0 and 3.0.
- Obtain legal council to assist in the drafting of land use agreements, access agreements, waivers and other contracts as well as advising on liability issues.

5.0 TRAIL PLANNING AND DESIGN

Proper planning and design are essential. Many liabilities arise directly from mistakes made long before construction begins or the first user sets foot on the trail. It is vital that the process begins with an intimate understanding of the land through which the trail will be routed and the uses proposed for the trail itself. While the uses will dictate such issues as trail width, gradient, paving material, sight lines and curve radii, the land will provide a series of constraints based on land form, slope, soil conditions, hydrology, ecology and naturally occurring hazards. Trail Operators/Managers/Owners should consider several potential alignments and choose the route that offers the most appropriate geometry and least hazards. This is not necessarily the alignment that is the least expensive or the most easily achieved. However, an alignment that best serves the anticipated uses and avoids existing hazards will greatly reduce potential risks to the users and liability to the Trail Operators/Managers/Owners.

The following are best practices to mitigate risk during trail planning and design:

5.1 TRAIL WIDTHS

Physical separation is most commonly achieved by providing a trail of sufficient width to allow for safe use by all participant groups.

The necessary width is based on the nature of the uses and the volume of use.

Trails that are too narrow can lead to overcrowding and higher incidences of collisions. Narrow trails can also result in the creation of informal side trails or braiding created when one user group attempts to avoid the other by cutting fresh trails. Braided trails are damaging to the surrounding land and can lead users into hazardous conditions. Trails should have sufficient width to make the creation of informal trails less desirable than following the established alignment.

- a. Non-Motorized Trail Tread Widths.
All dimensions shown here are in meters.

Non-Motorized Primitive Trail Tread Width

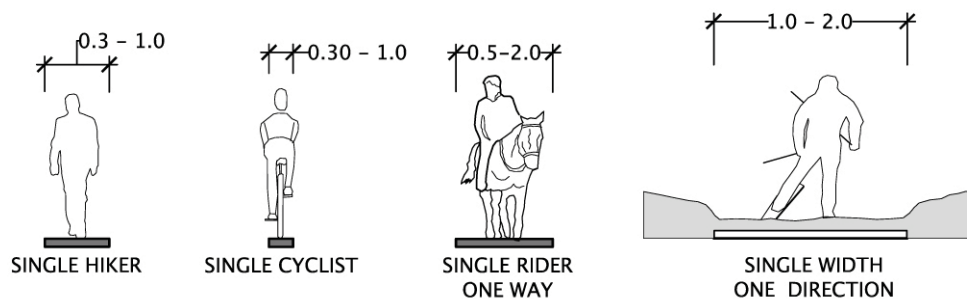

Non-Motorized Trail Tread Widths. (Cont.)
 All dimensions shown here are in meters.

Non-Motorized Semi-Developed Trail Tread Width

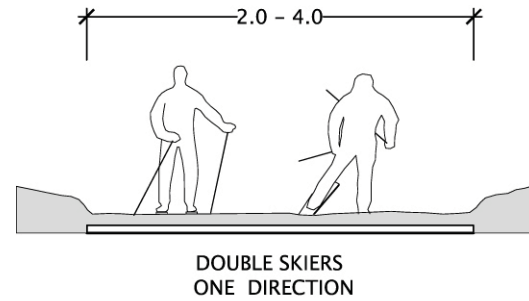
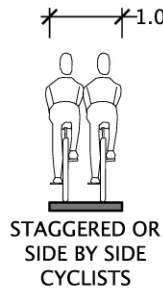

Non-Motorized Developed Trail Tread Widths

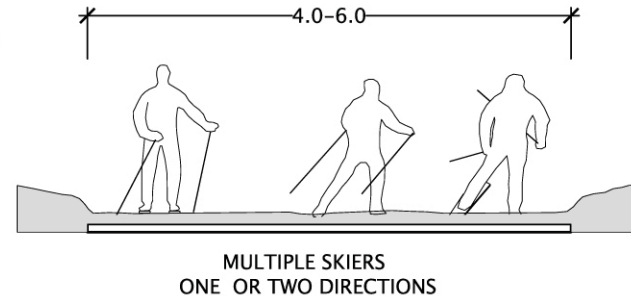
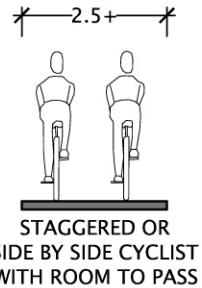

Multi-use Non-Motorized Trails – Depending on the combination of user types designated for the trail, trail widths should be designed to accommodate the user group requiring the widest width wherever possible. The figures below are examples of different trail surfacing and widths for multi-use non-motorized trails.

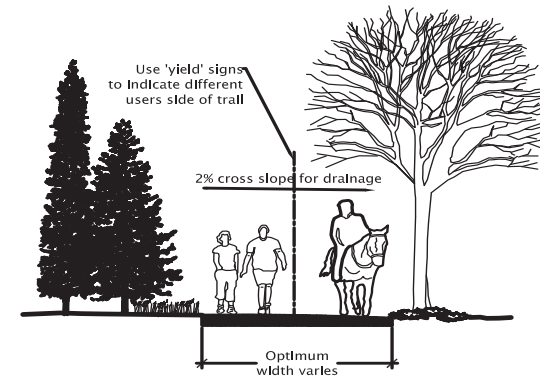
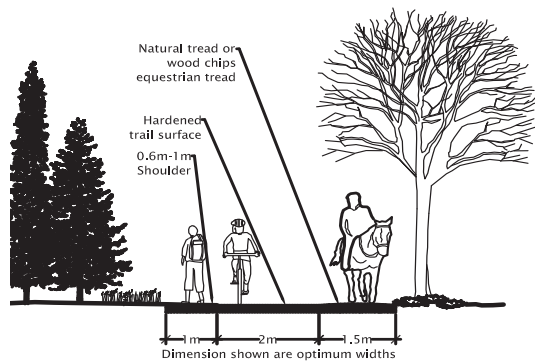

b. Motorized Trails Tread Widths.
All dimensions shown here are in meters.

Motorized Primitive Trail Tread Widths

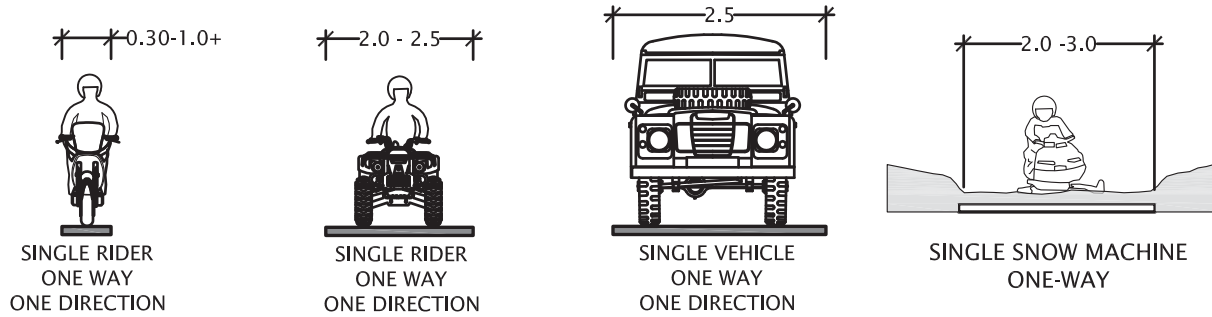

Motorized Semi-developed Trail Tread Widths

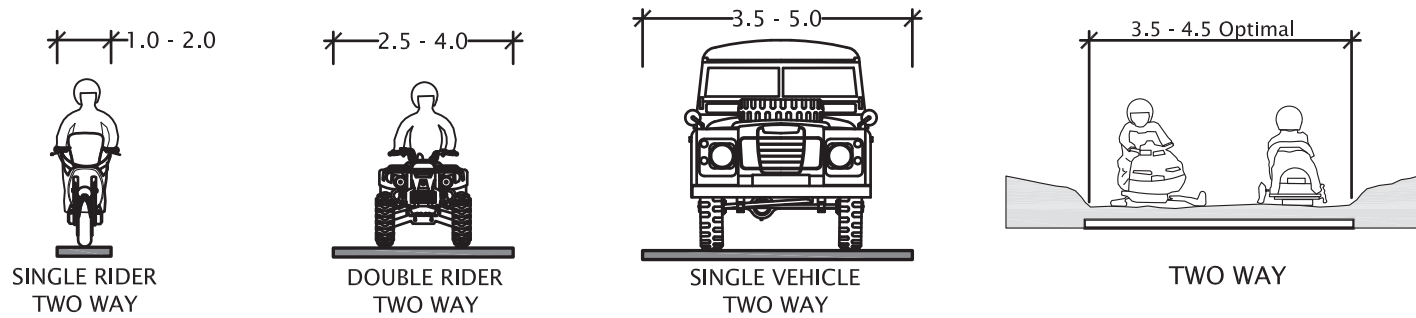

Motorized Developed Trail Tread Widths

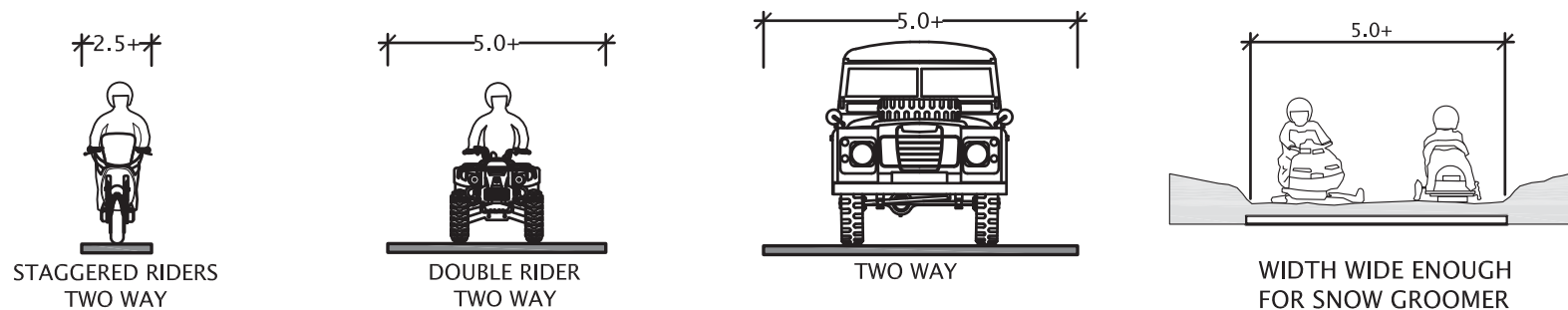

b. Motorized Trail Tread Widths. (Cont.)

Multi-Use Motorized Trails

Depending on the combination of user types designated for the trail, trail widths should be designed to accommodate the user group requiring the widest width.

c. General Trail Tread Width Information

Multi-Use Trails (Trails that accommodate a variety of user types, but non-motorized and motorized uses are not combined on this type of trail)

Trail Operators/Managers/Owners should also give consideration to how different groups of users will interact on the trail. For example, mixing cyclists with equestrians, or mixing snowmobiles and ATVs in the same season, on a trail, increases the risk and anxiety levels for all users. The central issue is that different user types move at different speeds, they have different maneuvering capabilities, and they require different trail surfaces to recreate on. For multi-use trails, it is important that there is sufficient trail width to provide a separation that is physically and psychologically comfortable for all user groups.

Mixed-Use Trails (Trails that accommodate both motorized and non-motorized uses)

More conflicts arise from mixed use trails than any other type of trail. This is because the variety of users that are allowed on these trails are incompatible. Various strategies are available to mitigate conflicts. These include providing physically separate but often parallel trails surfaces, dividing the trail surface, instilling trail etiquette through signage and trail user orientation programs, or separating the various uses by time, day or season. The optimal technique will depend on the nature of the activities involved and the consensus achieved amongst the majority of users.



5.2 TRAILS AND ADJACENT LAND USES

In selecting trail alignments, Trail Operators/Managers/Owners should consider their future relations with both the land owner of the existing site but also the land owners and users of adjacent parcels of land. Any change in land use, including the construction of a trail, can be seen as negative by adjacent land owners and or users. These negative sentiments can be partially mitigated by the use of appropriate setbacks, barriers and visual screening.

a. Trails located close to adjacent residential property owners

The most common concerns adjacent residential land owners have are with regard to loss of privacy, noise, trespassing, litter, vandalism and uncivil behavior. Trail design should take these into account when defining an alignment. Where possible, the trail and trail users should not be visible from adjacent properties. This visual separation can be achieved by a band of vegetation, such as preserved woodland, shelter belts or topographic features such as berms or grade changes in the land itself. Wherever possible, the visual barrier should be preserved as a feature of the landscape.

Where trails provide easy access to adjacent properties, consideration should be given to the construction of a security barrier such as a fence. Such barriers may range from a barbed wire fence intended principally to mark the property boundary to a substantial chain link fence intended to physically block access. The selection of the type of barrier will depend on the relationship between the Trail Operators/Managers/Owners and the adjacent property owner or user and should be designed to mitigate the real or perceived issues.

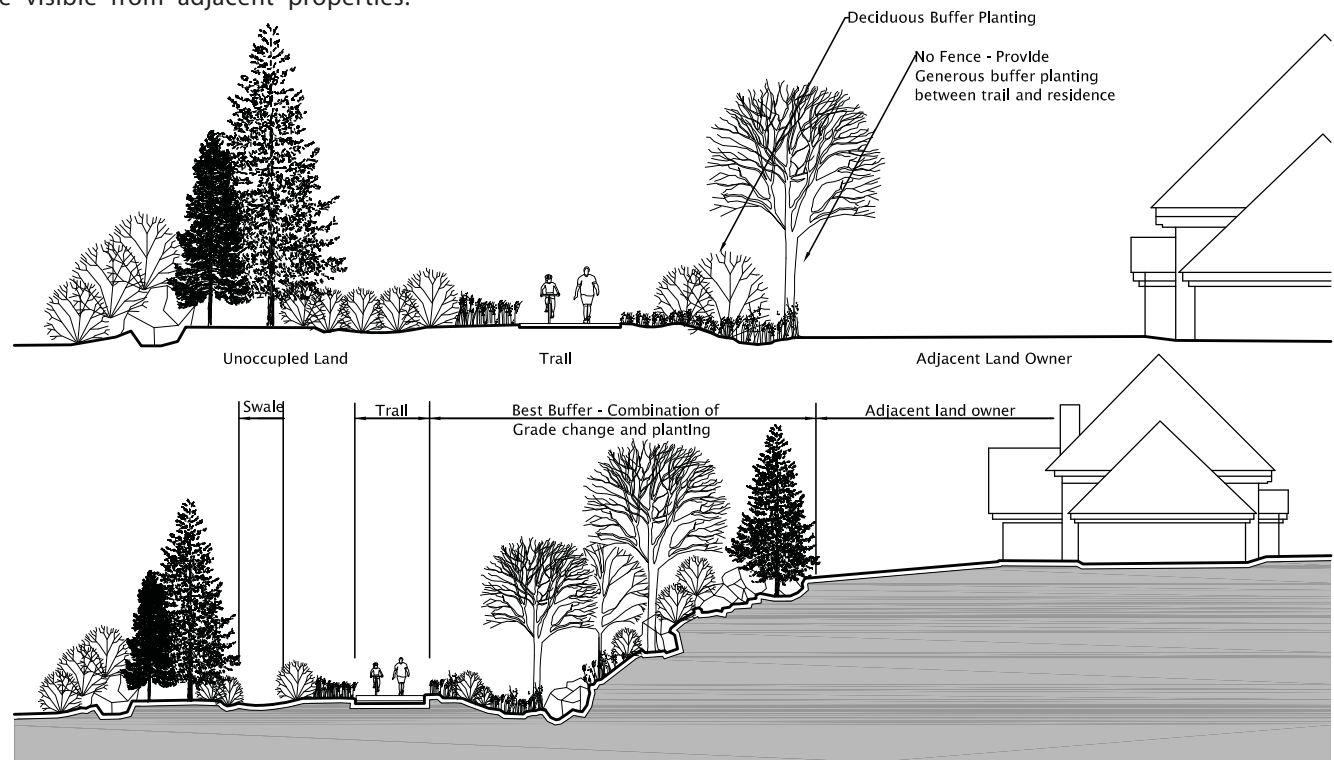

- b. Trails located on, or close to oil and gas pipelines, and other industrial utility corridors:

Generally, these industrial footprints are either owned or under formal lease/ disposition. Interested parties should first contact the appropriate authorities to seek their permission to route a trail in utility areas. In most cases, approval is required at a land use decision level by the land owner, as well as a clear understanding and operational agreement between the lease/disposition holder and the Trail/Operator/Manager. Please refer to section 1.0 for the common authorities, associated with public land. Where industrial footprints exists on public land, this land falls under the jurisdiction of Alberta Sustainable Resource Development.

In addition to contacting the owners and or land managers, trail proponents will also need to obtain permission from the appropriate company that holds the corridor, the trail is proposed to be located within.

Often, there is interest to run trails on or alongside utility corridors such as on public land. The misunderstanding is that these straight clear cut areas seem like easy places to route a trail. Individuals planning on doing this should be aware that the task may be much more capital and time intensive than they expect. As well, there may be more risks associated with trails in these locations.

The following are considerations to take into account, prior to planning a trail within these corridors:

- The approvals process can be complicated, time consuming and onerous on the Trail Operator/Manager/Owner;
- Most industrial disturbance areas, such as pipelines, overhead utility lines, well sites...etc. are not intended or designed to be for public use. These sites are often environmentally unsustainable as a trail. Clean up and maintenance can be an expensive investment;
- Maintenance can be more onerous as there are more stringent requirements one must adhere to when working around or within utility corridors. For instance, trail developers are expected to flag and protect all existing facilities and warning signs placed to warn trail users that they are on a utility easement whenever work is conducted in the area;

- Location of pipeline crossing need to be confirmed with the utility company to ensure they have adequate cover over the line. Armouring at those crossing points may be necessary to prevent damage to the pipe line.

The following are risks associated with building a trail within these corridors.

- Utilities can consist of transmission or pipe lines that conduct electricity, gas, oil or water. There is a real danger of trail crews hitting or damaging lines, putting lives in danger. If the damage to the transmission line is serious enough, it can put surrounding communities in danger too. The trail developer should call to have the location and depth of utilities located prior to the commencement of any construction activities;
- These corridors have very limited experiential value. Trails built in these areas are often straight and wide. Trails like these promote excessive speed increasing the number of accidents and conflicts that occur among trail users;
- There can also be risk to the trail users in the emergency events such as from fallen or entangled utility lines, leaks in the pipeline or other industrial spills or pollution due to the industrial nature of the land. Users should be made aware of all these risks while travelling on a trail located in these industrial corridors, and should have emergency contact information readily available along the trail should there any emergency arise.



This is an image of an exploded pipeline.

c. Rails with trails setback and buffer requirements

Railway setbacks vary depending on the location of the rail line, type of rail use and its proximity to urban areas, small towns or rail facilities. Where trails exist close to rail lines such as in urban areas, railway setbacks tend to be much narrower, and trails can be found in close proximity to the railway. Trails near high speed rail lines will tend to be separated by greater distance and physical barriers.

Anyone wishing to route a trail close to the railway should request permission from the appropriate land owner as well as the rail company operating the rail line. Trail Operators/Managers/Owners should also consider the risk involved with routing a trail along a rail line.

Common risks associated with trails located next to active railway lines include: objects falling from a train, train derailment, chemical spills and, trespassing. For these reasons, safety buffers should be used when routing a trail in close proximity to an operating rail line.

The following are typical required railway setbacks:

- The minimum setback for a railway is 30m measured from the center of the track.
- The minimum typical setback from a rail facility such as rail yard and any major train stopping point is between 60m -150m.
- The narrowest typical setback for a railway is 7.6m measured from the center of the track.

The following are examples of the types of buffers and barriers used when routing trails close to rail lines:

- Safety Berms
- Fencing
- Sound walls
- Thick Vegetation (e.g. living walls)
- Grade differentiation between trail and rail line.

In many instances, a combination of buffering systems are used to separate trails from active rail

Railway trespassing risks:

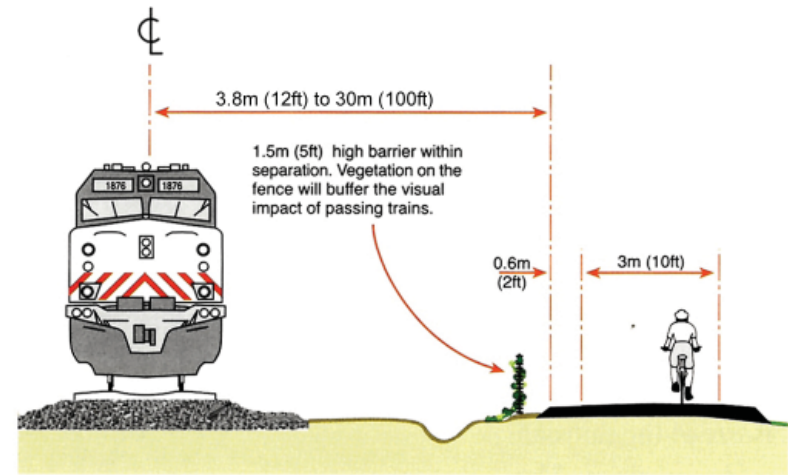

Minimum Setback between Rail and Trail

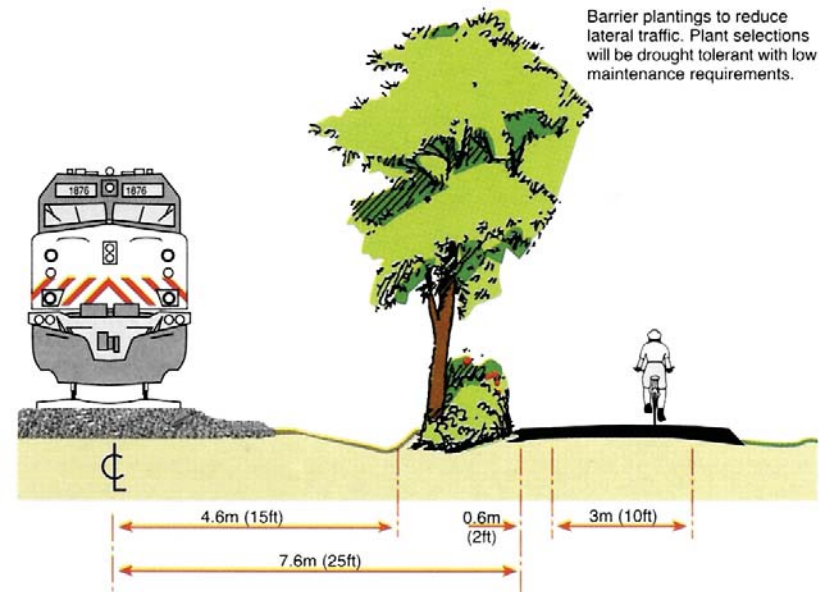

Trail Buffer Technique - Using Vegetation as a Buffer

These illustrations are taken from the book titled: "Rails with Trails", published by the US Department of Transportation

Trespassing is a common problem rail companies face. Studies have found that people in general, will take the shortest and most convenient route to cross the tracks regardless of potential danger and in spite of warning signage and signals.

Planning the crossing of the rail line should be a top consideration. Ensure that a trail crossing is placed in the most logical and convenient location to allow users to reach their destination. The more direct the line of sight is between the crossing and the destination the safer the crossing will be.

Studies have also shown that trespassing typically happens on tracks not separated by fencing.

The following are considerations to minimize accidents at railway crossings:

- Trails should intersect all rail crossings at 90 degree angles to allow good visibility.
- On high use rail lines, provide swing gates or maze barriers to force trail users to come to stop before crossing the rail line.
- Where necessary or required by the railway authorities, provide visible warning signage, visual and auditory signals, automatic control arms and fencing on high use trails crossing an active railway. Trail users should be warned at the trail head to stay off the railroad tracks.
- Have trails cross at an approved crossing location such as a road wherever possible.

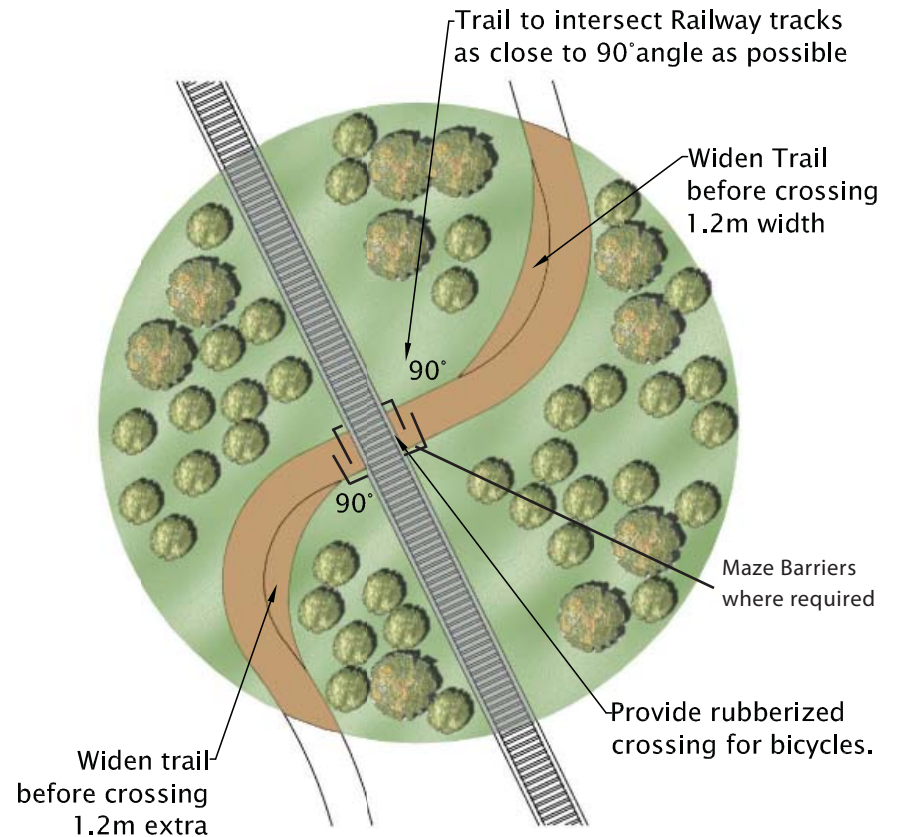

d. Highways and major roads with trail setback and buffer requirements:

Under current Alberta provincial law, trails are not allowed to be developed within “three(3) numbered provincial highway” rights-of-ways. However, bicycles, walkers and horses can legally use the right of way. There are currently no standards or guidelines dictating highway trail design. However in some cases, where there are no other options, the authorities may grant permission for a short stretch of trail to be constructed within a highway right of way. This section provides some information on the risk associated with building trails along highways, and potential strategies to mitigate this risk.

Trails within municipal road allowances are controlled by municipalities under bylaws. Trail developers should contact their local municipalities for permission to locate a trail along a municipal road.

Vehicle speed limits are much faster on highways than most other roads. Common risks associated with trails located next to highways are: wind, objects falling or protruding from vehicles, poor visibility, confusion resulting from headlights at night, vehicular accidents and ditch roll-overs. Trespassing in the form of trail users attempting to cross highways is also a significant problem as highways are much wider with deep ditches and have restricted visibility. These conditions contribute to the increased possibility of trail user accidents with vehicles.

For these reasons setbacks and buffers should be used when routing a trail close to highways.

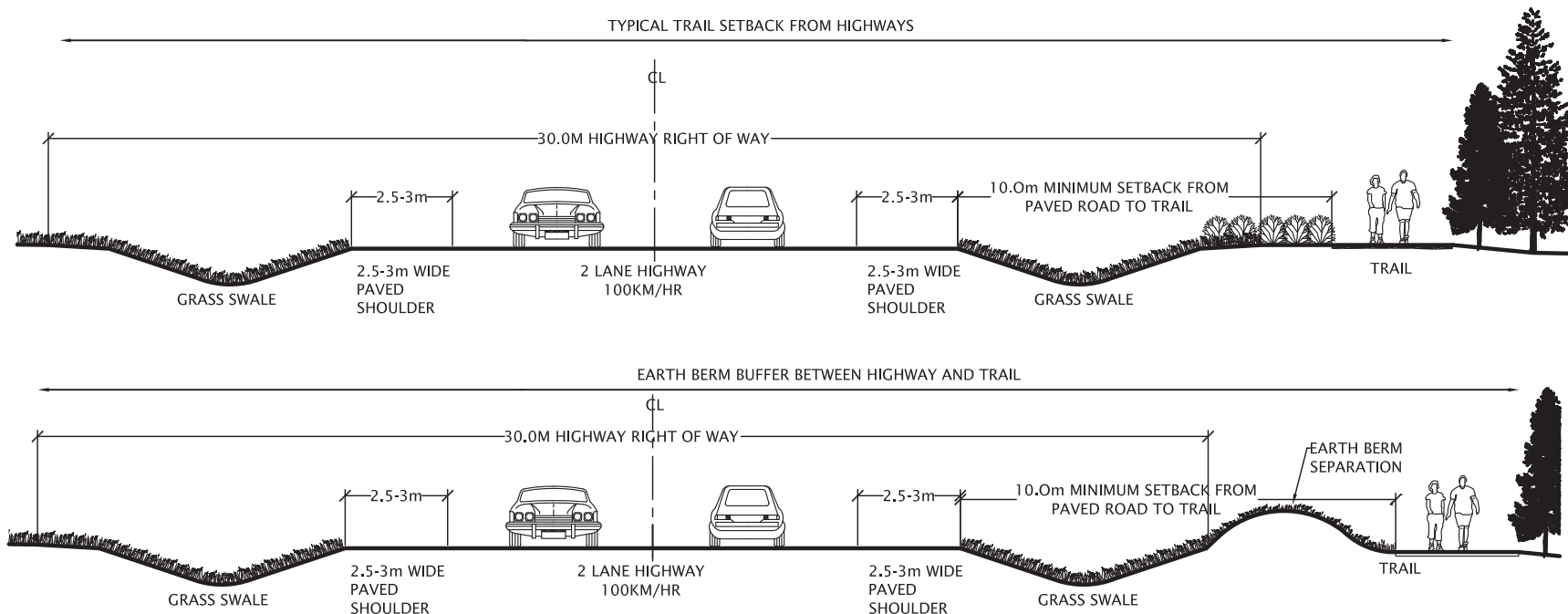

Please contact the appropriate transport and land authorities to obtain approval before contemplating any trails close to a municipal or provincial highway.

The following general requirements should be considered:

- The typical two lane highway right of way in Canada is 30m.
- A 10m setback from the edge of paved road is a minimum guide line to route trails beside highways.

Trail crossing across highways with speed limits in excess of 70km/hour are discouraged. If a crossing is required, this crossing should be designed within town limits or at highway intersections. Vehicular speeds can decrease significantly, as a highway approaches a town or major highway intersections and the visibility of trail users is much clearer to the driver in a vehicle. Wherever possible, locate trail crossing at traffic light intersections and stop signs on the road.

The following are examples of the types of buffers to consider

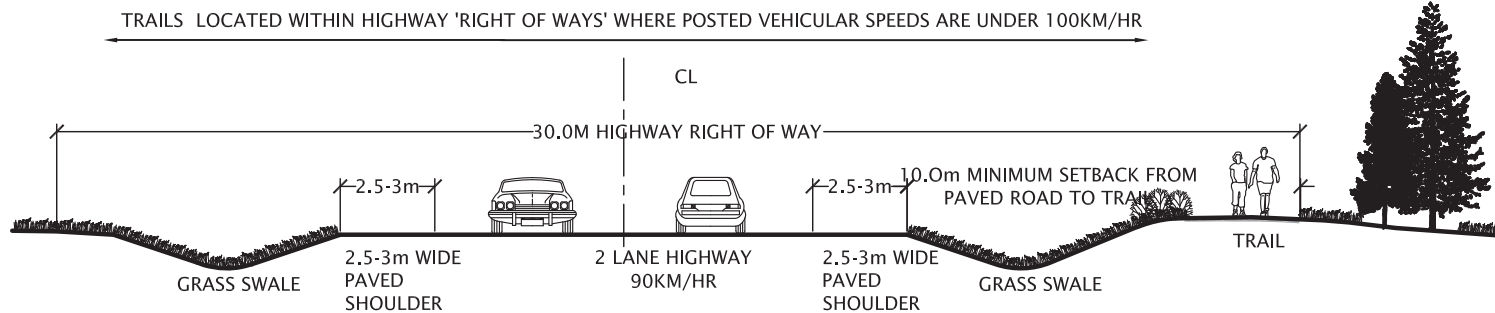

using when routing trails in close proximity to highways.

- Safety berms, ditches
- Fencing
- Concrete barricades or guard rails
- Thick Vegetation
- Grade differentiation between highway and trail.

In many instances, a combination of buffering systems should be considered when planning trails close to highways.

If one must plan trails close to highways, develop the trail on a bench along the topside of the right-of-way, wherever topography and terrain allow.

d. Trails setback and buffer requirements beside roads:

The figures on the right illustrate the minimum setback requirements for trails to be placed beside roads, where road speeds are 70km/hour or less.

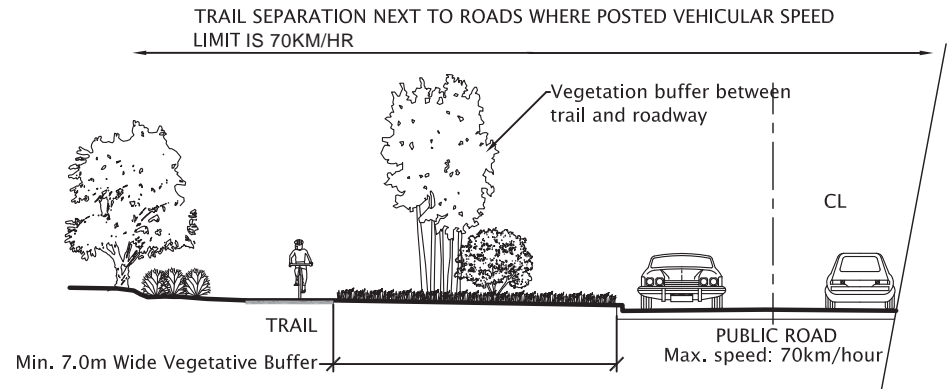
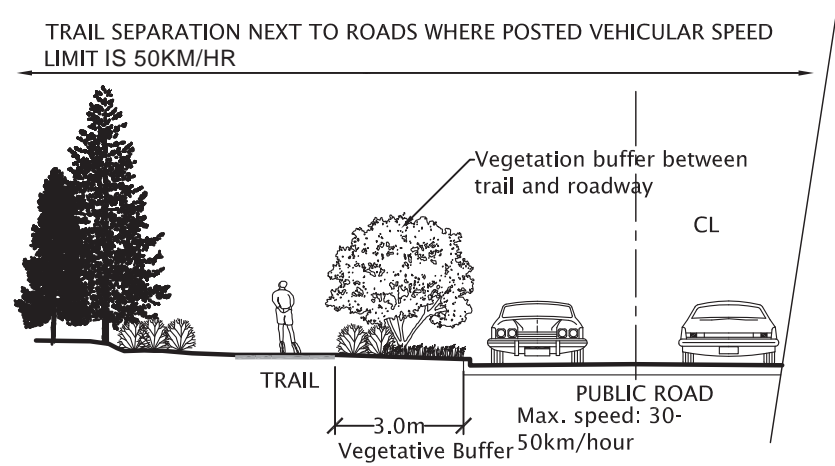

5.3 TRAIL ROUTING AND ALIGNMENT

Trail routing and alignment, in combination with trail width, establish the operating capacity of the trail. They define how the trail can be used and by how many. Creative routing of trails allows for varied experiences and may allow different uses to comfortably share the same trail network. The alignment of individual sections of the route makes the trail suitable or unsuitable for specific uses and can be a very effective way of separating uses on multi and mixed use trails.

Where possible, the Trail Operators/Managers/Owners should design a trail that provides a series of varied experiences along its length. While the trails may be used for a variety of functions, the trail itself should be an experience.

a. Trail Network Design

Whenever possible, design a loop or stacked looped trail system where users do not have to exit the trail from the same path they entered from. Dead-end trails are discouraged due to the lack of escape routes during emergency situations. Dead end trails are usually designed when there is a specific destination point in mind such as a single point of interest, and (or) the surrounding terrain is not conducive for a longer length of trail.

Stacked looped trails provide more trail options for users, and are an effective way of separating incompatible user types and user levels of experience and fitness. On mixed use trails and multiple use trails, this type of trail system reduces conflicts among trail users where user types and levels of experience and fitness vary greatly.

A stacked loop system lessens conflict between hikers, recreational cyclists, and serious extreme mountain bikers. It also lessens the conflict between equestrian users and hikers. A stacked loop system can separate groomed snowmobile trails from other motorized users.

Stacked looped trails can also provide users with a variety of landscapes and interesting challenges for all users. Users are less likely to leave the trail when a trail is interesting.

The following are example stacked-looped layouts for different trail uses:

TYPICAL MOUNTAIN BIKE TRAIL LAYOUT

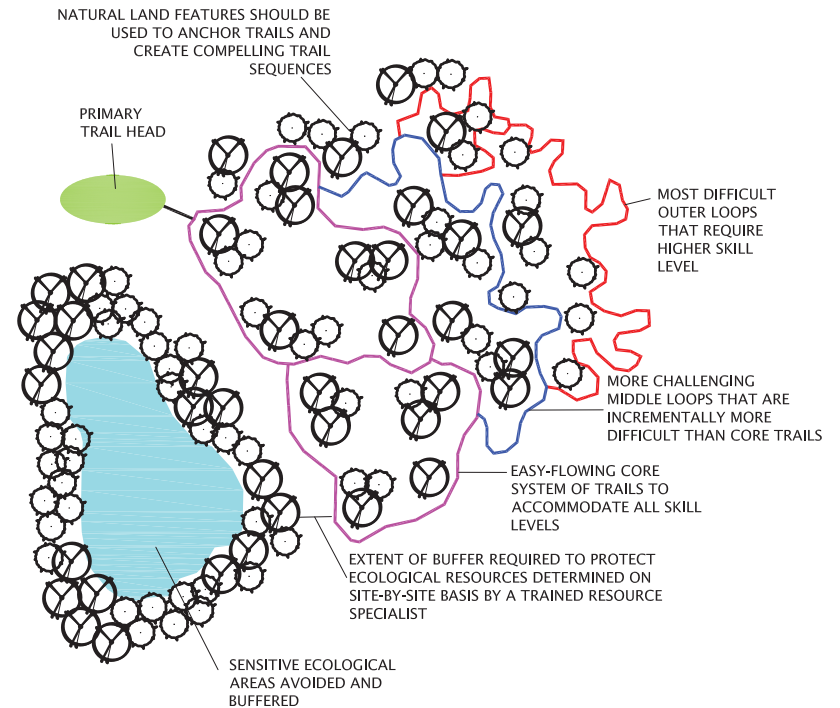

TYPICAL LOOPED SKI TRAIL LAYOUT

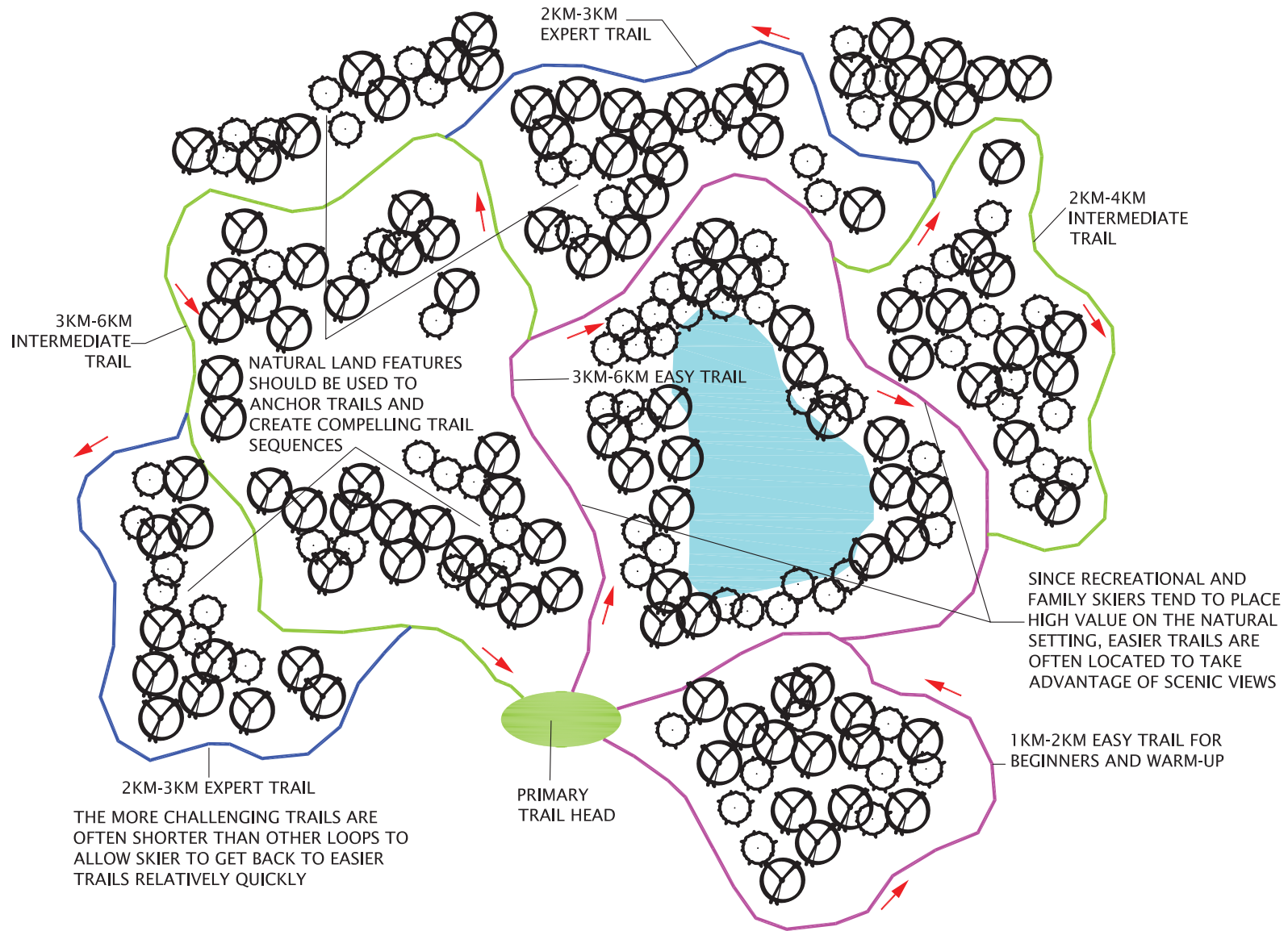

TYPICAL EQUESTRIAN TRAIL LAYOUT

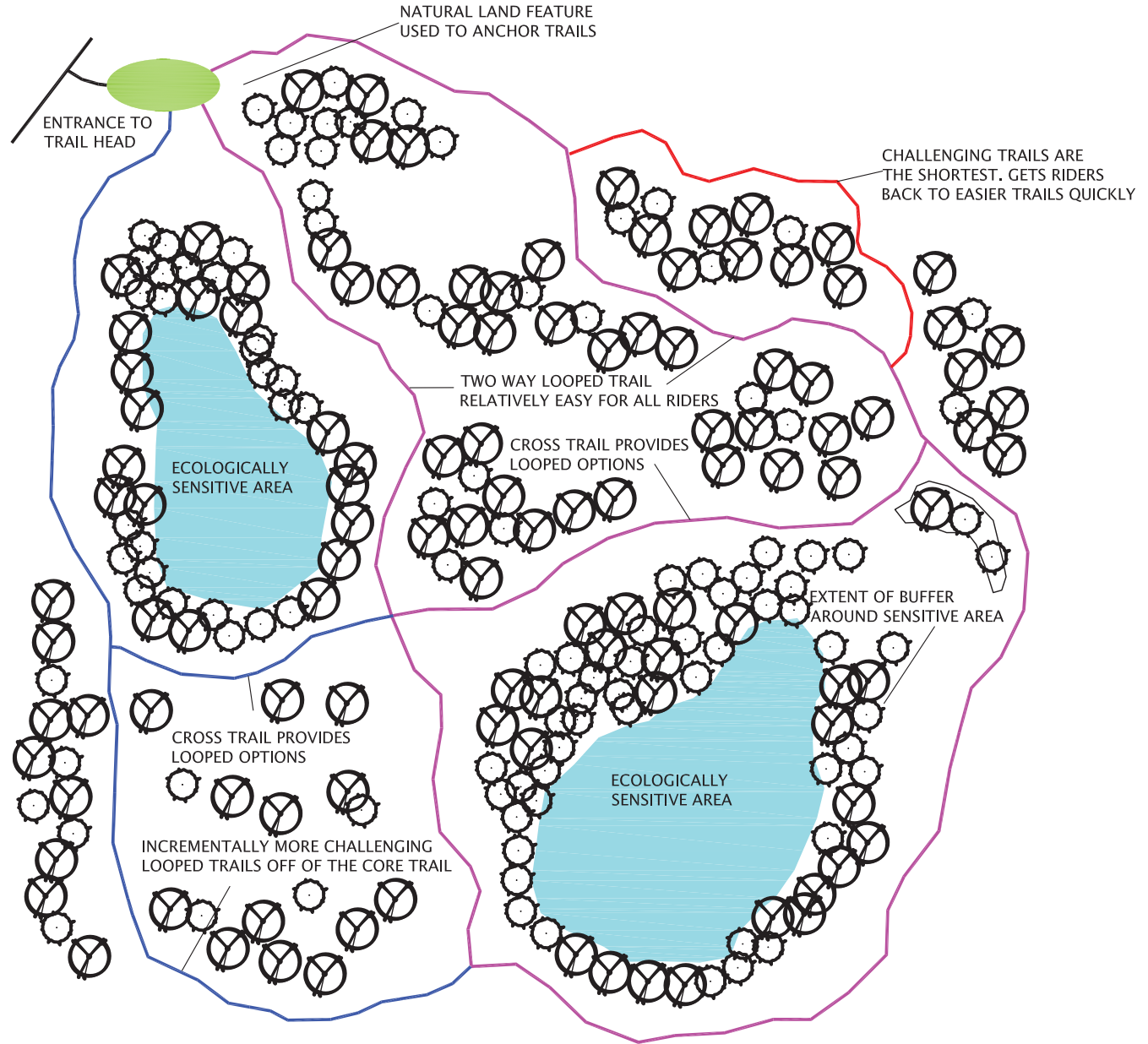

TYPICAL OFF HIGHWAY VEHICLE (OHV) TRAIL LAYOUT

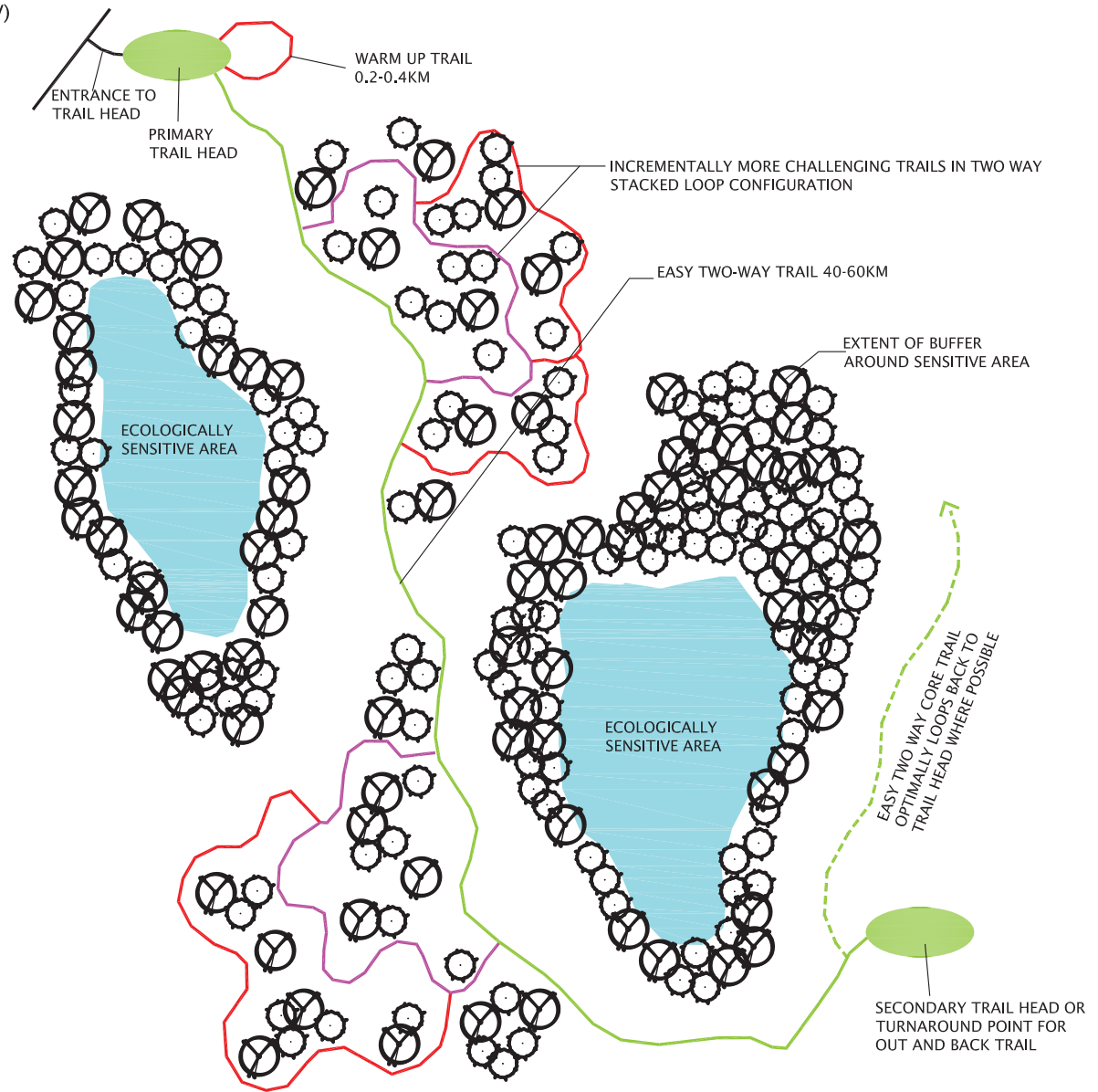

b. Clear Sight Lines

Sight lines are important for both safety and aesthetic reasons. For the purposes of this document, safety is the principle consideration. In general, sight lines should lengthen in proportion to the speed of the users on the trail. Therefore, hikers require shorter minimum sight lines than equestrians. Motorized vehicles require longer sight lines than cyclists. The central issue is allowing users to avoid collisions and eliminate the need for sudden changes in direction which can be very hazardous at high speed. Longer sight lines may be required where unusual conditions occur or where the nature of the trail makes maneuvering difficult, for example where the trail unavoidably narrows due to site constraints. In considering sight lines, the design should account for light levels and the potential for conditions that may limit visibility such as a fog, dust or snow.

Sight lines can be altered over time by the growth of vegetation, or the construction of various site features. Sight lines should be checked on an ongoing basis as part of the regular maintenance of the trail.

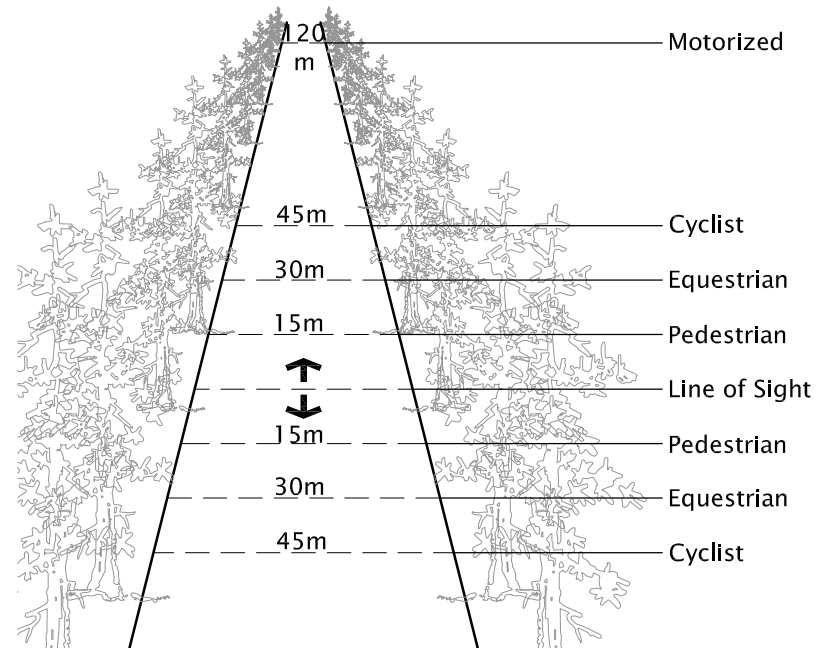

i. Unobstructed views

Provide unobstructed forward and rear views when approaching rail or road crossings. The following are the suggested unobstructed forward and rear sight distances for specific user trails:

- Pedestrians: 15m
- Equestrians: 30m
- Cyclist: 45m
- Motorized trails: 120m

ii. Visibility triangles

Maintain proper visibility triangles at all trail intersections; Visibility in these triangles should not be obstructed by vegetation and other vertical elements. Routes with the fewest number of intersections should be selected.

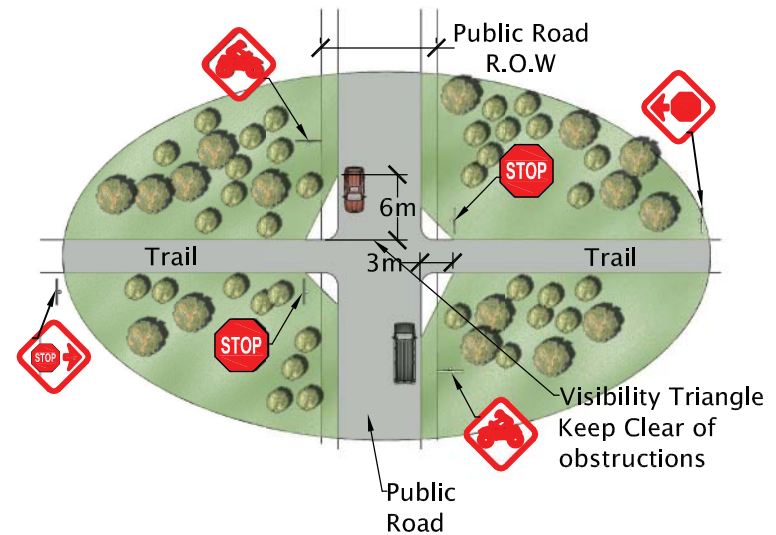

iii. Trail crossing at road intersections or rail lines

- Trails should intersect all road crossings at 90 degree angles where possible.

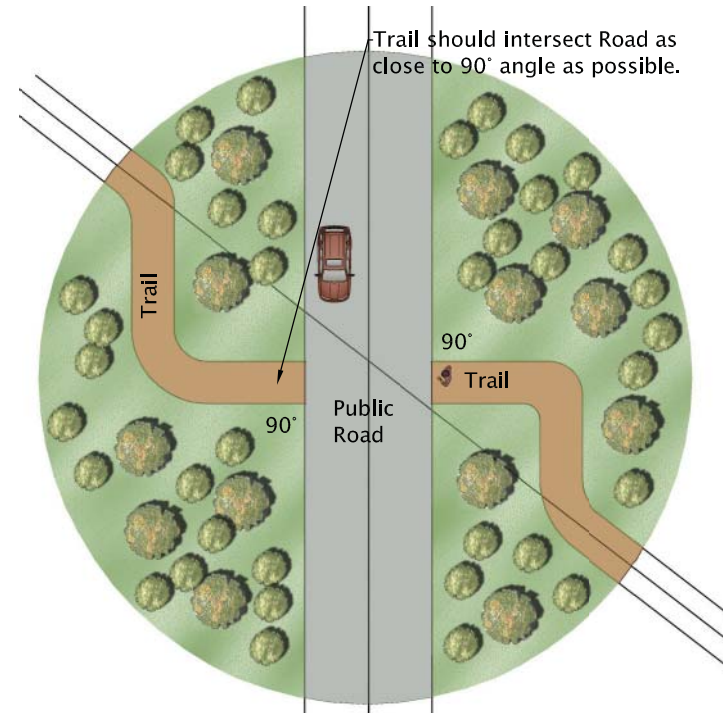

- Trail crossing for equestrians:

Where a trail intersects a public road or railway right of way, provide stopping areas on both sides to allow riders to halt and assess the traffic before crossing.

- Trail crossing for cyclist and mountain bikes:

Trails should be at the same grade as the tracks when it intersects the railway crossing. Widen trail at the intersection to give cyclists adequate room to cross tracks at a right angle.

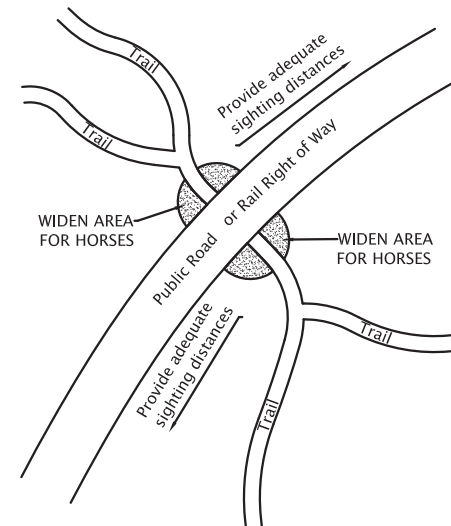

iv. Sight lines to consider for cyclist and mountain bike trails:

- Widen or provide a pull off at high use areas.
- Widen trail around sharp bends, and thin vegetation to provide clear sight lines for users coming around each side of the bend.

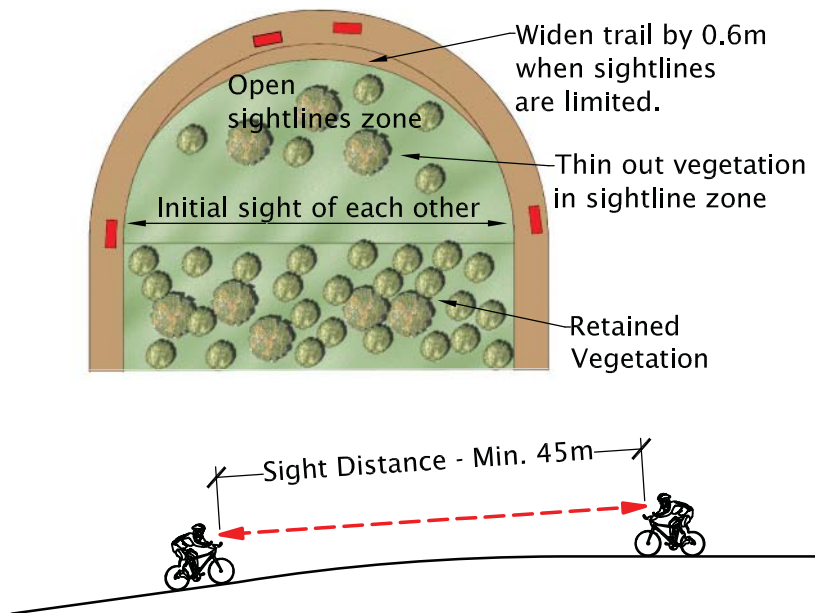

v. Sight lines to consider for cross country skiing trails:

- When routing downhill routes, keep in mind that the longer and steeper the run, the straighter and longer the run-out area needs to be. Run-outs should be at least as long as the slope in order to dissipate speed and allow a skier to regain control before a sharp curve or another downhill section. If space is limited, a rise in grade at the bottom of the slope can offset the loss of the run-out distance.
- Provide an adequately wide clearance zone to allow the skier to fall or slide off the trail several feet without crashing into a tree or heavy brush.
- Avoid sharp curves at the end of a downhill run. The minimum turning radius for turns at the end of a downhill run is 30m.
- The minimum turning radius for flat trails is 15m.

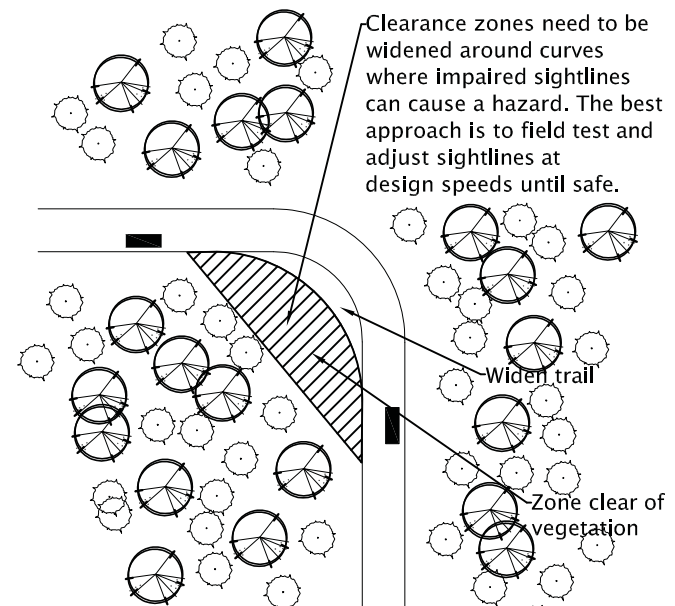

- v. Sight lines to consider for motorized trail users
- Provide a clear line of sight around curves;
- Provide a clear line of sight around sharp bends and blind corners;
- Widen curves on switch backs or where side slopes exceed 50%:
 - Snowmobile: Widen curves on outside corners by 0.3 – 0.6m
 - All terrain vehicle: Widen curves on outside corners by 0.3m - 0.6m
 - Off-road vehicle : Widen curves on outside corners by 1.2 - 1.5m
 - Off-highway motorcycle: Widen curves on outside corners by 0.1 - 0.15m

- Widen trails by providing pull offs or passing sections at high traffic areas to minimize user conflicts. The figures below illustrate this type of trail design.

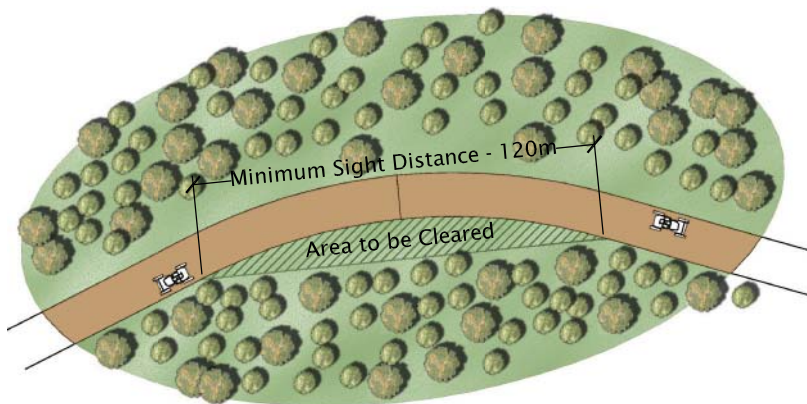

LINE OF SIGHT - HORIZONTAL CURVE

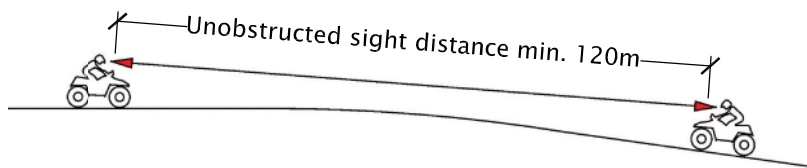

LINE OF SIGHT - VERTICAL CURVE

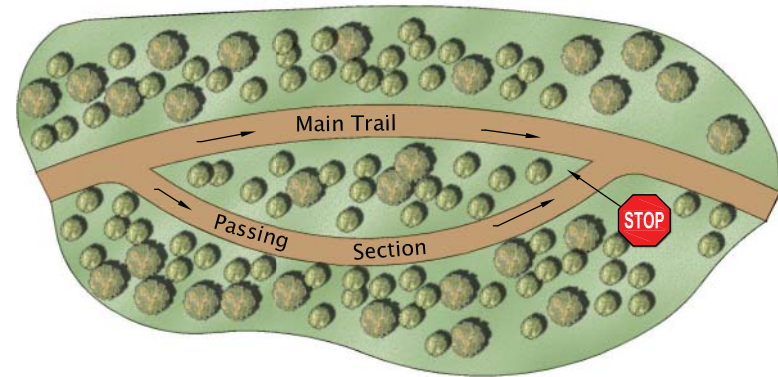
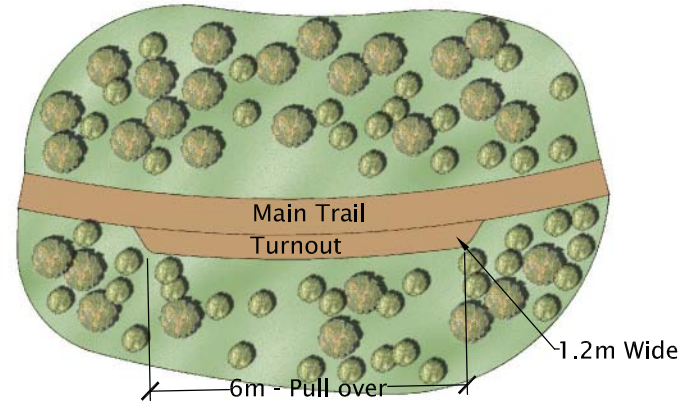

c. Tree Clearing

Tree removal should be done only in circumstances where there is no other reasonable option for developing a safe trail alignment. In general, Trail Operators/Managers/Owners should accommodate trees by adjusting trail routes to avoid compromising either the roots or the canopy of existing trees. If possible, additional space for the trail or sight lines should be achieved by pruning rather than clearing trees. Where this is not possible, priority should be given to the preservation of younger mature trees in good health.

A clear exception to the above is the removal of trees that pose a safety risk. Any tree that is structurally unsound or for reasons of poor health or other cause is likely to fall on or across the trail should be removed as part of the trail development process.

All tree pruning and clearing should be undertaken by professions familiar with such work. The evaluation of tree health and stability should be undertaken by a registered arborist.

Where healthy trees exist in areas where visibility is an issue use selective clearing. Do not clear cut. If clear cutting has been undertaken in surrounding areas, it is better to cut up to the edge of the trail, rather than leave a thin buffer. These buffers directly next to trails only result in blow downs and higher maintenance.

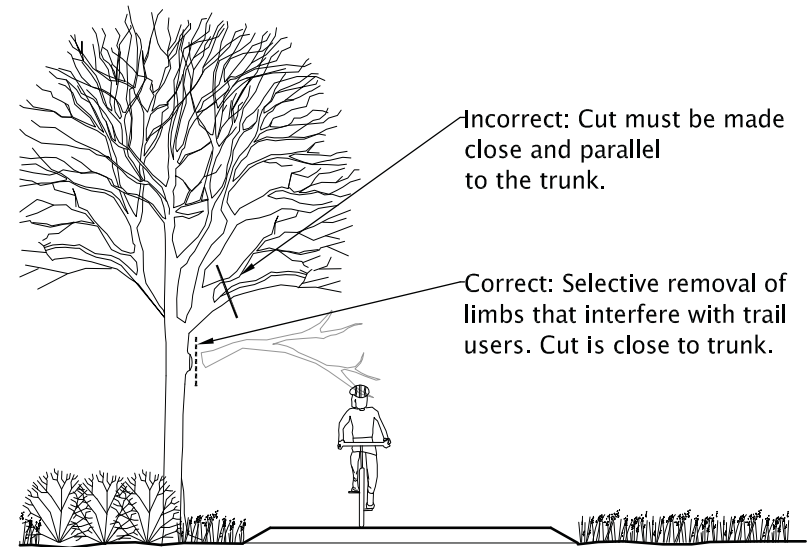

Proper Tree Pruning for Vertical Clearance
The figure above shows the correct removal of tree limbs.

The picture below show a large number for trees blown down after a storm due to improper clearing practices.



d. Railings

- Railings fall generally into two categories: hand rails and guard rails. Hand rails are used in a variety of circumstances to assist hikers. They should be designed to be easily gripped, have a smooth finish and be free of splinters or other hazards. They should be designed and constructed to have a sturdy appearance and feel;
- Guard rails separate hikers and other users from hazards. They should be designed and constructed to have a sturdy appearance and feeling;
- All railings should be designed to meet or exceed the requirements of local codes. Railings must be inspected on a regular basis as part of the maintenance program to ensure they remain in good condition and continue to perform their intended function;
- Provide guard rails along hazardous slopes or steep drop-offs such as over bodies of water and along cliffs;
- Guard rails should be installed on all ramps and bridges. Guard rail height requirements vary depending on types trail use:
 - The minimum railing height requirements on pedestrian trails is 1.05m height.
 - The minimum railing height requirements on horse or bicycle trails is 1.35m height.

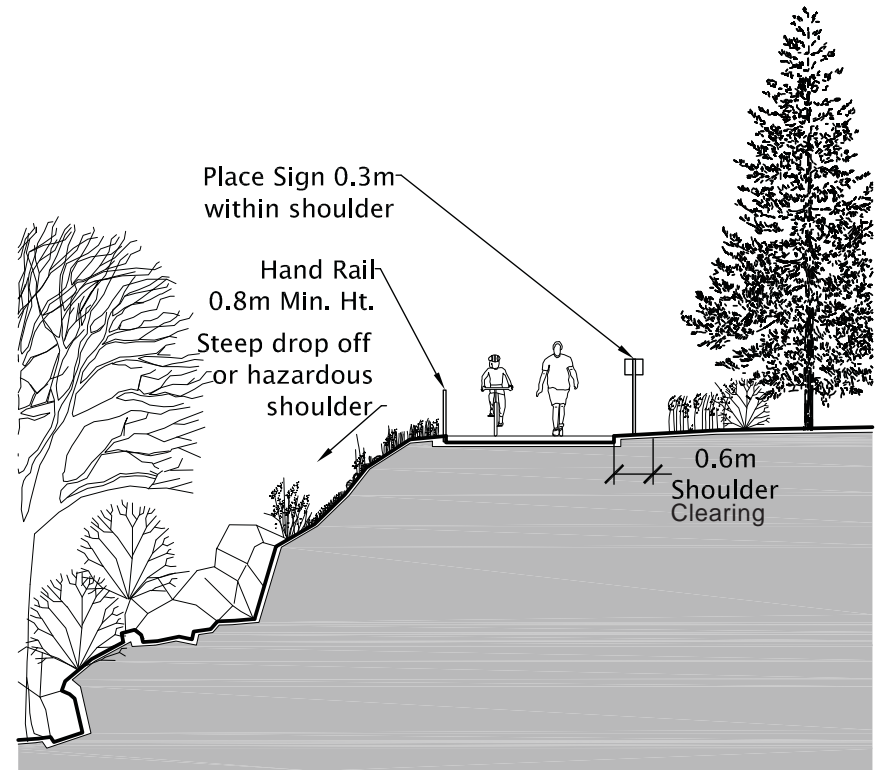

5.4 TRAIL GRADING AND SLOPE

Each user group will have distinct tolerances with respect to grading and slopes. At no time can a trail exceed these tolerances for any of its intended users. Therefore, the user group that requires the most moderate conditions will define the maximum allowable slope on the trail. It should be noted that the figures provided here are guidelines only. Site conditions on individual trails may require a more conservative grading option. In areas where the trails are likely to be frequently wet or ice-covered, lesser gradients are advisable.



Conditions that limit visibility should result in lesser gradients.

The following are acceptable trail design grade tolerances for different trail uses.

a. Trail Design Grades

Hikers, Snowshoers, Cross Country Skiers: Ideal trail grades are between 4% to 10%.

With the exception of short runs where the length of the run does not exceed 15m. Trails can sustain maximum grades as high as 12% - 40%.

Cyclist: Ideal trail grades are between 3% to 5%.

Mountain Bikers: Trail grades vary greatly depending of level of difficulty of trail. The average grade for mountain bike trails is less than 10% with the exception of short runs where the length of the run does not exceed 15m. Trails can sustain maximum grades as high as 15% to 25%. In extreme cases, the maximum grade for runs less than 5m is 45%.

Equestrian: Ideal trail grades are between 2% to 5%.

Trail grades generally do not exceed 10% with the exception of short runs where the length of the run does not exceed 15m. Grades are not to exceed 20%.

Horse and Wagon: Ideal trail grades are between 2 - 5%. Trail grades should not exceed 15% over short distances.

Motorized Trail Users: Ideal trail grades are between 3% to 8%.







Trail grades generally do not exceed 10% with the exception of short runs where the length of the run does not exceed 4m. These short sections can sustain maximum grades as high as 15% to 35%.

For reference purposes, the following 3 pages shows a summary of typical trail grades, trail width, clearing heights and width used for different types of trails in Alberta. These charts are excerpts from the “Alberta Recreation Corridor & Trails Classification System” document.

USER PROFILE SUMMARY CHARTS

Class

Non-Motorized



Users	Experience	Trail Surface	Gradients	Trail Width	Clearing Width	Clearing Height
PEDESTRIAN						
	Primitive	Natural	Steep (up to 45%)	0.3m-1m (1-3ft)	1m-2m (3-6ft)	2.5m (8ft)
	Semi-developed	Granular	Gentle to moderate (up to 20%)	1m-2m (3-6ft)	2m-3m (6-8ft)	3m (10ft)
	Developed	Compacted Granular or Paved	Gentle (up to 5%)	2.5m+ (8ft+)	3.5m+ (11ft+)	3m (10ft)
CYCLISTS						
	Primitive	Un-surfaced	Steep (up to 30%)	0.2m-1m (8in-3ft)	1m-2m (3-6ft)	2.5m (8ft)
	Semi-developed	Granular	Gentle to moderate (up to 15%)	1m-2m (3-6ft)	2m-3m (6-10ft)	3m (10ft)
	Developed	Hard surface	Gentle (up to 10%)	2.5m+ (8ft+)	3.5m+ (11ft+)	3m (10ft)
SMALL WHEELED USERS						
	Primitive	N/A	N/A	N/A	N/A	N/A
	Semi-developed	Packed or Paved	Gentle (up to 10%)	1m-2m (3-6ft)	2m-3m (6-10ft)	3m (10ft)
	Developed	Paved	Gentle (up to 5%)	2m+ (6ft+)	3m+ (10ft+)	3m (10ft)
EQUESTRIAN						
	Primitive	Unsurfaced	Steep (30% +)	0.5m-2m (18in-6ft)	1.5m-2.5m (5-8ft)	3.5m (11ft)
	Semi-developed	Semi packed	Moderate to steep (up to 15%)	1m-3m (3-10ft)	2m-4m (6-13ft)	3.5m (11ft)
	Developed	Packed	Gentle (up to 10%)	3m+ (10ft+)	4m+ (13ft+)	3.5m (11ft)
HORSE & WAGON						
	Primitive	Natural	Steep (up to 15%)	2.5m (8ft)	3m-4.5m (10-14ft)	3.5m (11ft)
	Semi-developed	Semi packed	Gentle to moderate (up to 10%)	3.5m (11ft)	4.5m-5m (14-16ft)	3.5m (11ft)
	Developed	Packed	Gentle to moderate (up to 10%)	4m+ (13ft+)	5m+ (16ft+)	3.5m (11ft)
CROSS-COUNTRY SKIING						
	Primitive	Ungroomed	Steep (up to 30%)	1m-2m (3-6ft)	1m-2m (3-6ft)	3m (10ft)*
	Semi-developed	Occasionally groomed	Gentle to moderate (up to 20%)	2m-4m (6-12ft)	2m-4m (6-13ft)	3m (10ft)*
	Developed	Trackset or Packed	Gentle (up to 10%)	4m+ (13ft+)	4m+ (13ft+)	3m (10ft)*

* above average snow level

USER PROFILE SUMMARY CHARTS

Class

Non-Motorized

Users	Experience	Trail Surface	Gradients	Trail Width	Clearing Width	Clearing Height
SNOW SHOEING						
	Primitive	Ungroomed	Steep (up to 30%)	0.75m-1.5m (2-5ft)	0.75m-1.5m (2-5ft)	2.5m (8ft)*
	Semi-developed	Groomed	Gentle to moderate (up to 20%)	1.5m-2.5m (5-8ft)	1.5m-2.5m (5-8ft)	3m (10ft)*
	Developed	Groomed and packed	Gentle (up to 10%)	2.5m+ (8ft+)	2.5m+ (8ft+)	3m (10ft)*
DOG SLEDDING						
	Primitive	Ungroomed	Steep (up to 30%)	1.5m-2.5m (5-8ft)	1.5m-2.5m (5-8ft)	3m (10ft)*
	Semi-developed	Single track	Gentle to moderate (up to 20%)	2m-3m (6-10ft)	2m-3m (6-10ft)	3m (10ft)*
	Developed	Double track	Gentle (up to 10%)	3m+ (10ft+)	3m+ (10ft+)	3m (10ft)*

Class

Motorized

B1 - TWO-WHEELED MOTORIZED VEHICLE

	Primitive	Unsurfaced	Steep (up to 45%)	0.3m-1m (1-3ft)	0.75m-1.5m (2-5ft)	3m (10ft)
	Semi-developed	Natural, rutted	Gentle to Moderate (up to 15%)	1m-2m (3-6ft)	2m-3m (6-10ft)	3.5m (11ft)
	Developed	Natural, smooth	Gentle (up to 10%)	2.5m+ (8ft+)	3.5m+ (11ft+)	3.5m (11ft)

B2 - WIDTH <1.27m (50") MOTORIZED VEHICLE

	Primitive	Unsurfaced	Steep (up to 30%)	1.5m-2.5m (5-8ft)	2.5m-3.5m (8-11ft)	3.5m (11ft)
	Semi-developed	Natural, rutted	Gentle to Moderate (up to 20%)	2m-3m (6-10ft)	3m-4m (10-13ft)	3.5m (11ft)
	Developed	Natural, smooth	Gentle (up to 10%)	3m+ (10ft+)	4m+ (13ft+)	3.5m (11ft)





B2(S) - WIDTH <1.27m (50") SNOW VEHICLE

	Primitive	Ungroomed	Steep (up to 45%)	2m-3m (6-10ft)	2m-3m (6-10ft)	3.5m (11ft) *
	Semi-developed	Occasionally groomed	Moderate (up to 20%)	5m+ (16ft+)	5m+ (16ft+)	5m (16ft) *
	Developed	Regularly groomed	Gentle (up to 15%)	5m+ (16ft+)	5m+ (16ft+)	5m (16ft) *

* above average snow level

USER PROFILE SUMMARY CHARTS

Class Motorized

Users	Experience	Trail Surface	Gradients	Trail Width	Clearing Width	Clearing Height
B3 – WIDTH 1.27m (50") to 1.65M (65") MOTORIZED VEHICLE						
	Primitive	Unsurfaced	Steep (up to 30%)	2m-3m (6-10ft)	3m-4m (10-13ft)	3.5m (11ft)
	Semi-developed	Natural, rutted	Gentle to Moderate (up to 15%)	2.5m-4m (8-13ft)	3.5m-5m (11-16ft)	3.5m (11ft)
	Developed	Natural, smooth	Gentle (up to 10%)	5m+ (16ft)	6m+ (16ft)	3.5m (11ft)
B3(S) – WIDTH 1.27m (50") to 1.65M (65") SNOW VEHICLE						
	Primitive	Ungroomed	Steep (up to 30%)	2m-3m (6-10ft)	2m-3m (6-10ft)	3.5m (11ft)*
	Semi-developed	Occasionally groomed	Gentle to Moderate (up to 20%)	5m+ (16ft)	5m+ (16ft)	5m (16ft)*
	Developed	Regularly groomed	Gentle (up to 15%)	5m+ (16ft)	5m+ (16ft)	5m (16ft)*
B4 – WIDTH 1.65m (65") or more MOTORIZED VEHICLE						
	Primitive	Unsurfaced	Steep (up to 45%)	2m-4m (6-13ft)	3m-5m (10-16ft)	3.5m (11ft)
	Semi-developed	Natural, rutted	Moderate to Steep (up to 40%)	3.5m-5m (11-16ft)	4.5m-6m (15-19ft)	4m (13ft)
	Developed	Natural, smooth	Gentle (up to 10%)	5m+ (16ft)	6m+ (19ft)	4m (13ft)
B4(S) – WIDTH 1.65m (65") or more SNOW VEHICLE						
	Primitive	Unsurfaced	Steep (up to 30%)	2m (6ft)	3.5m (11ft)	3.5m (11ft)*
	Semi-developed	Sufficient Snow	Gentle to Moderate (up to 20%)	4m-5m (13-16ft)	5m+ (16ft)	5m (16ft)*
	Developed	Sufficient Snow	Gentle (up to 15%)	5m+ (16ft)	5m+ (16ft)	5m (16ft)*

* above average snow level

5.5 MINIMIZING USER CONFLICT BY CONTROLLING SPEED ON TRAILS

The faster speed of 'wheeled' trail users compared to other trail users is often at the root of trail conflict. Trail Operators/Managers/Owners must fully appreciate that some mountain biking and OHV(ing) are adrenaline driven sports, and while there are always a few renegades, most trail users are responsible, conscientious individuals who seek an enjoyable experience, not excessive speed.

Trails that have built-in natural limitations such as twist and turns, rougher surfaces, narrower tread and natural obstacles will provide challenges and thrills for wheeled users, and at the same time keeping speed down, thereby reducing user conflict.

Posting speed control signage has negative appeal to trail users, and is rarely heeded since there are few resources to patrol this. As such, signage is not a recommended choice of speed control.

The following points 5.6 and 5.7 are speed control strategies that a trail operator should plan and build for if wheeled users are allowed on the particular trail.

5.6 SPEED CONTROL FOR MOUNTAIN BIKING TRAILS

The following are effective natural speed control strategies:

1. Use rhythm and consistent trail flow.
2. Corral the trail by using objects to emphasize turns.
3. Use more single track and narrow trails to slow mountain bikers down. Wide open segments promote higher speeds.
4. Utilize grade changes (large humps) and turns. Straight wide trails promote excessive speed.
5. Install choke points.
6. Modify surface texture to slow mountain bikers down.



5.7 SPEED CONTROL FOR MOTORIZED TRAILS

The following are examples of effective speed control strategies through the use of good trail design and tread manipulation. Posting speed limit signs have limited ability to control speed.

Wide open and straight segments promote higher speeds, whereas, views, interesting elements, and trail surface modification force riders to slow down and take more notice of their surroundings.

1. Exposure: Sudden exposure to views, steep drop offs from side slopes increases the dramatic feeling of exposure.
2. Transition: Grade changes, tight curves, and thick vegetation all create challenges for the user. Challenge force riders to slow down and take more notice of their surroundings.
3. Variety: Bridges, obstacles and natural elements in the landscape that narrow and/or create direction changes on the trail add interest.
4. Modifying trail surface: Create rough tread using rocks and boulders. This requires skillful negotiation around these obstacles and will slow trail users down.



1.



2.



3.



4.

5.8 STAGING AREAS

Conflicts arise when incompatible users are forced to congregate in limited space such as the start of a trail head or campground. For example, horse camps and other trail users have been a source of conflicts, due to size of vehicles, smell, environmental impacts and other issues.

Separate horse camps and staging areas from other trail users such as hikers, back packers. Locate hitching posts resting stalls well away from other trail user campsites. Provide separate campgrounds for equestrian and other users.

Motorized vehicles are loud and their machines pollute the air. Consider separating trail head and staging areas away from quiet trail users such as hikers, cyclist, cross country skiers and equestrian.

Where possible, provide separate entrance and exit points into trail-head parking lots, especially along heavily traveled roads. Try not to design dead end parking lots.

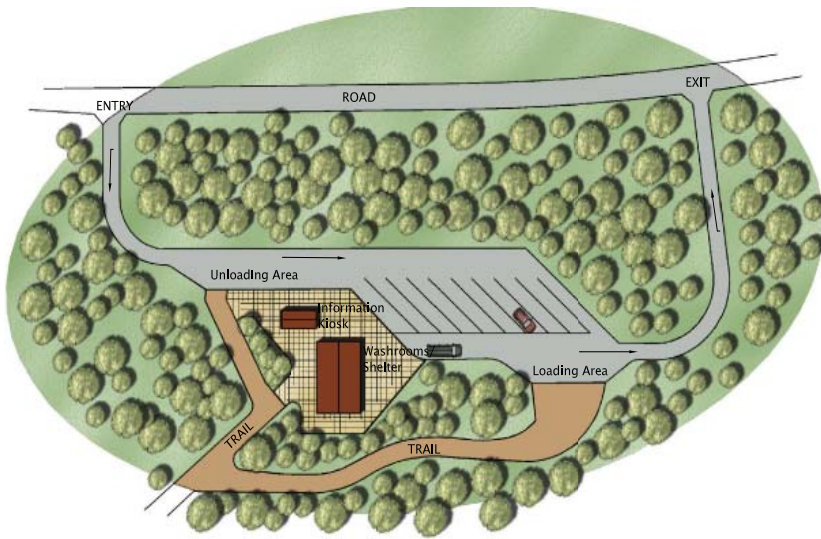

For horse and other motorized trail uses, provide ample room for unloading in a safe area, away from parking lot traffic circulation.

Provide loading ramps.

Entrances and exits should be offset from other road intersections by at least 15m. Wherever possible, entrance/exits should favor right hand turns.

Single traffic lanes in parking lots should be 3.5m wide, double lane, 7.3m wide. Turning radii at entries and exits should be at least 4.5m.

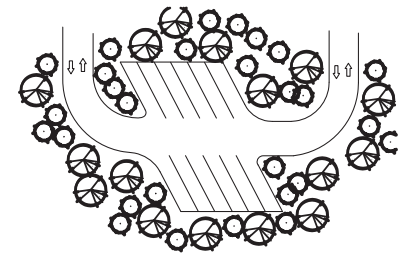

Two Way Through Traffic

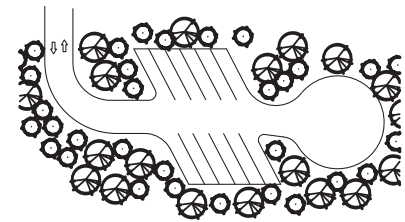

Two Way Through Traffic with Turnaround

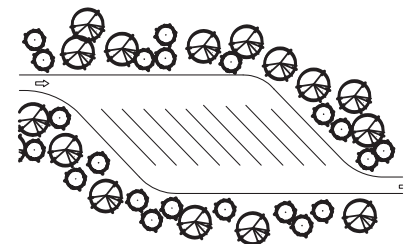

One Way Traffic with Horse or ATV Parking

6.0 TRAIL CONSTRUCTION

Trail construction requires an understanding of typical construction details and how to apply them to site specific conditions. The stability and durability of the trail is directly proportional to the quality of trail construction. Improper construction will lead to higher maintenance costs and potential liability issues. In addition, changes to accepted standards in the intended use of the trail may require retrofit and upgrade of the trail. Trails must be built to the standard of the most demanding use intended for the trail. They must also be constructed to discourage unintended uses.

During the construction period, Trail Operators/Managers/Owners must ensure that there is restricted access to the work site.

Construction sites represent a significant source of liability. Only workers actively involved in the construction should enter the work area.

In addition, care must be taken during the construction of the trail and associated infrastructure to ensure that the work does not result in adverse affects on the surrounding land. Works associated with trail construction can result in landslides, mud flows, erosion, fires and the contamination of water courses. Trail Operators/Managers/Owners should use appropriate measures to ensure that such issues do not occur. When in doubt, professional advice should be sought from a civil engineer, ecologist or landscape architect regarding appropriate measures.

The following pages of this section are best practices to mitigate risk during trail construction.



BEFORE



DURING



ALMOST DONE

6.1 REQUIRED VERTICAL CLEARANCES

Trees directly alongside trails need to be checked regularly to ensure that low hanging branches are pruned and broken branches removed, to maintain proper vertical clearance heights for trail user safety. Branches that are too low can cause serious injury to trail users who might not see the branch until they've collided into it. For typical tree vertical clearance limits, please refer to page 32 - 34 of this document for trail user profile summary charts. The following sketches show the minimally acceptable vertical clearances for trails.

Pedestrian: Provide 2.0m of vertical clearance throughout the trail.

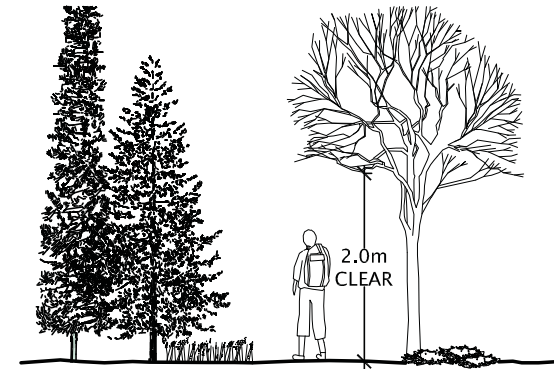

Cyclist: Provide 2.5m of vertical clearance throughout the trail.

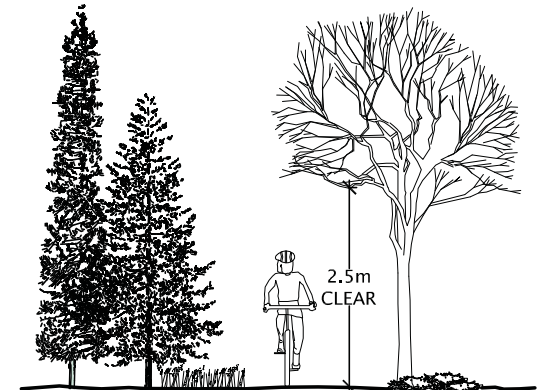

Cross Country Skiing: Provide 3.0m vertical clearance above average snow level throughout the trail.

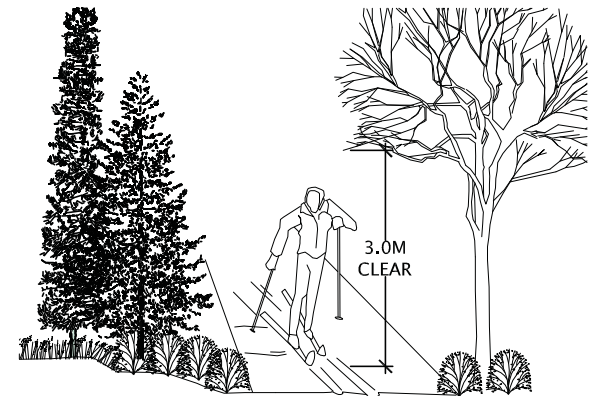

6.1 REQUIRED VERTICAL CLEARANCES

Equestrian: Provide 3.0m of vertical clearance throughout the trail.



Horse Drawn Vehicle: Provide 3.5m vertical clearance throughout the trail



Snowshoeing: Provide a 3.0m vertical clearance above average snow level throughout the trail.

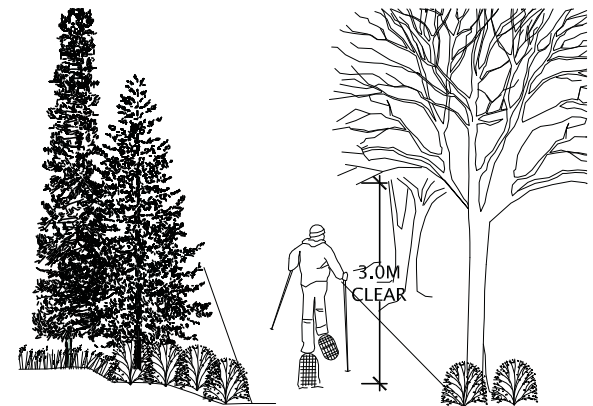

6.1 REQUIRED VERTICAL CLEARANCES

Dog Sledding: Provide a 3.0m vertical clearance above average snow level, throughout the trail.

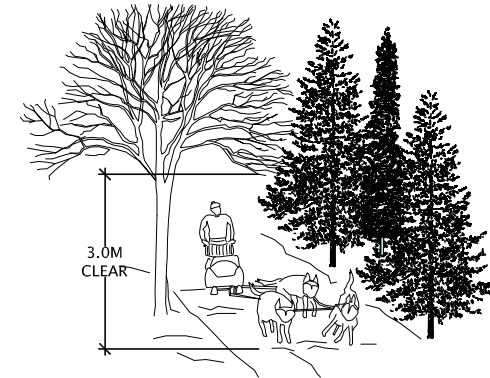

Snow Vehicles with width less than 1.27m,
Snow Vehicles with width between 1.27m and 1.65m:
Provide a 3.5m vertical clearance above snow pack, throughout the trail.

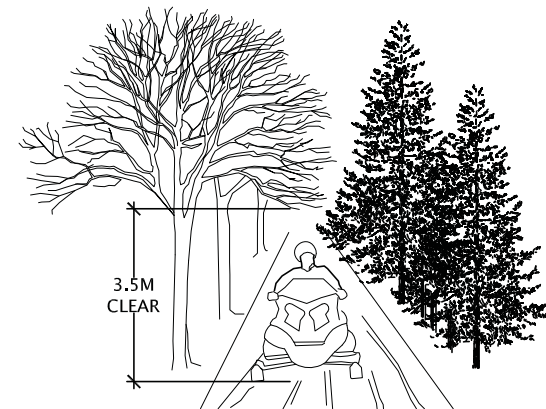

Snow Width with width greater than 1.65m :
Provide a 5m vertical clearance above snow pack, wide clear path of travel
throughout the trail.

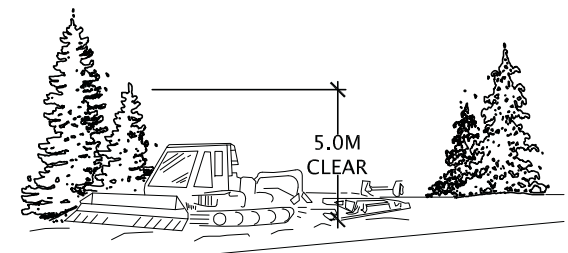

6.1 REQUIRED VERTICAL CLEARANCES

Motorized Vehicle with width less than 1.27m,
Motorized Vehicle with width between 1.27m and 1.65m:
Provide a 3.5m vertical clearance throughout the trail

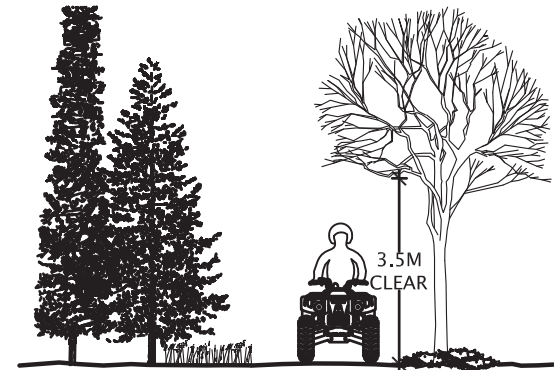

Motorized Vehicle with width greater than 1.65m:
Provide a 4.0m vertical clearance throughout the trail

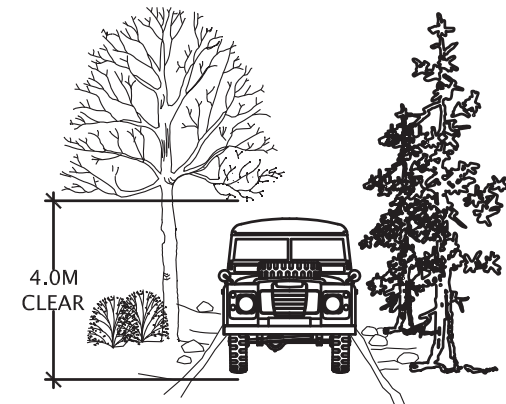

Two Wheeled (one front, one back) Motorized Vehicle:
Provide a 3.5m vertical clearance throughout the trail

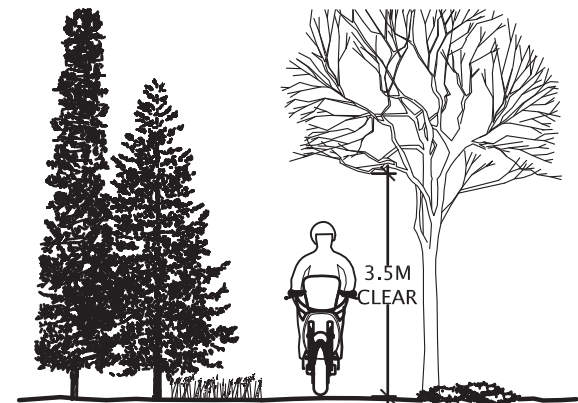

6.2 TRAIL EROSION CONTROL

Water is potentially the most detrimental element a trail can face. Erosion is the particular problem. Erosion can attack the surface of the trail, its edges or its base. The mechanism is simple. Moving water has the capacity to carry away loose particles of materials. The size of particles that can be moved is directly proportional to the volume and speed of the water. Do not underestimate the destructive potential of erosion. In general, there are two principles to follow that will minimize the potential for erosion.

1. Do not allow water flows to concentrate
2. Do not allow water to gain speed.

The following are trail grading techniques that a trail developer should employ when building any trail for use at any time of the year

ROLLING GRADE DESIGN FOR TRAILS

Sideslope. Rolling grade is most effective when the trail is traversing slopes of 20 to 70%. On sideslopes of less than 20%, draining dips become more difficult. On sideslopes greater than 70%, traversing the slope becomes too difficult.

Tread grades. Rolling grade is most effective when tread grade is less than 1/4 to 1/3 of the sideslope. To avoid drainage problems, no part of the trail should be completely level

Tread crest. Local high points that divide the trail into separate tread segments for drainage control.

Hardened tread. Used where native soils and rolling grade techniques cannot be effective.

Sustainable native tread. Shaped from native soil and rock

Drainage crossing. All natural drainage channels and swales, no matter how small or intermittent are crossed with a tread dip. This ensures that the site drainage continues its original course instead of flowing off course resulting in erosion.

Larger drainage features may require culverts or bridges

Tread climb. The steepness and length of the tread is determined by the soil type, trail use and site drainage characteristics.

Edge buffer. Refers to an small berm or shoulder on the outside of the tread. Used to increase the sense of visitor safety on steeper sideslopes.

Tread dip. Local low point that drains tread runoff to the downside slope

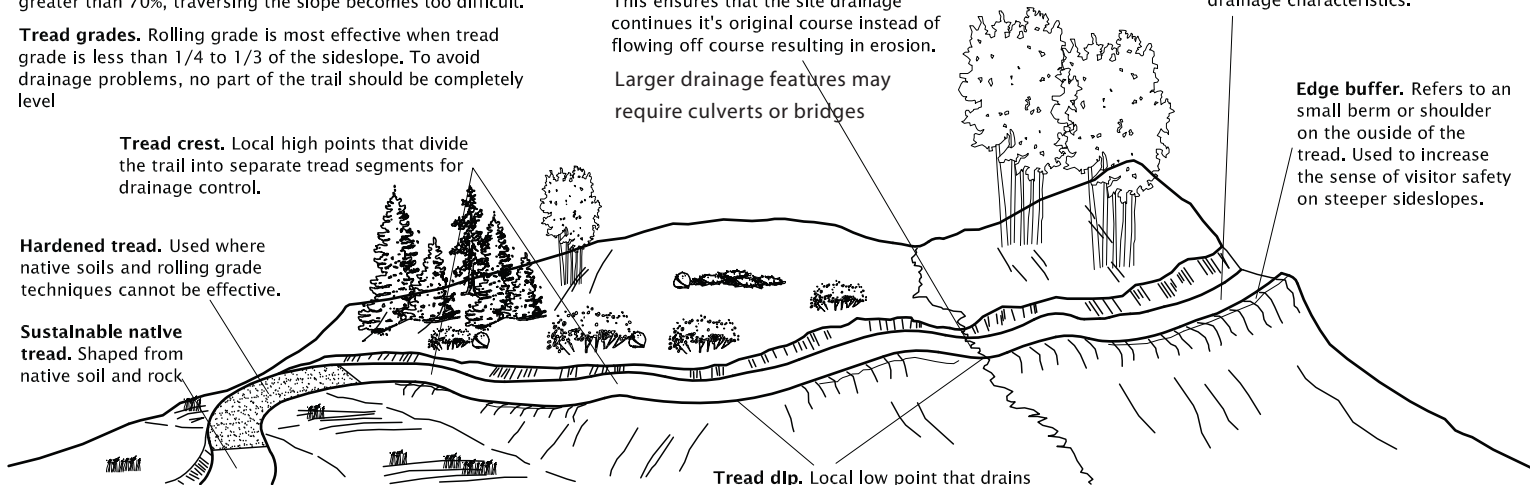

Credit: Trail Planning, Design and Development Guidelines - Minnesota Department of Natural Resources - Trails and Waterways

- a. Heed the "Half Rule": This means a trail's grade should never exceed half the grade of the sidehill it is located on. If the grade does exceed half the sidehill, it is flirting with the fall line, and will be more susceptible to erosion. For example if one is designing a trail across a hillside with a slope of 20 percent, the trail-tread grade should not exceed 10 percent. (See next page for illustration)
- b. Align trails using the "rolling grade design pattern". Wherever possible, route trails parallel to slopes and maintain a minimum trail cross slope of at least 2%. The figure below describes this design pattern in detail.
- c. As a general design guideline, keeping the average trail grade/slope to 10% or less is most sustainable for the trail's longevity.
- d. Maintain existing vegetation directly next to the trail, or plant drought resistant native shrubs, ground cover and grasses along slopes adjacent to trails. Plant root systems stabilize the soils on slopes thereby greatly reducing the risk of erosion.

- e. Avoid locating trails perpendicular to a slope. The picture below shows how environmentally devastating and dangerous heavily eroded trails can be.



- f. Avoid trail alignment on flat areas for long stretches, this causes water ponding, soil saturation and eventual degradation of the trail surface.



- g. Where possible, route trails close to a ridge point, NOT right along the top of the ridge. Poor trail construction and/or severe rain storms can severely compromise the stability of the trail. The trail will invert and cause water to run down the center channel of the trail thus heavily eroding it. If one has no choice but to route a trail along the top of a ridge, ensure that the trail is crowned and the tread is raised a minimum of 6" above the existing adjacent grades. Trail surfaces should be hardened when located on top of a ridge.

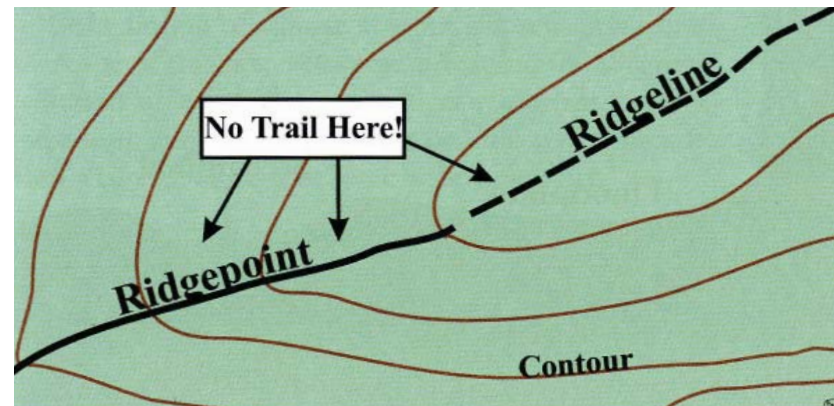

Picture credit: 'Pennsylvania Trail Design Manual'

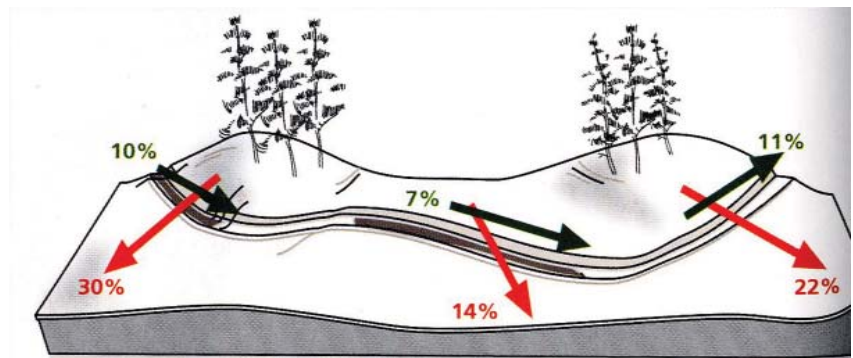

"Half-Rule" Illustrated

Picture credit: "IMBA's guide to providing great riding"

6.3 TRAIL EDGE PROTECTION TECHNIQUES:

Where trails traverse a side-slope, trail users tend to avoid the outside edge. The steeper and higher the drop off below the trail, the farther away from the edge trail users prefer to stay. Trail users avoiding the outside edge of a side slope tread often results in out-sloped trails failing when compaction and displacement of the tread center deepens over time. This center line deepening creates an unintended drainage channel along the trail, as water cannot sheet-drain off the side slope as originally designed.

The following figures illustrate different edge protection techniques that can be used to prevent unintended berms from building on the sides of out-sloped trails.

1. In-slope: A narrow tread can be shaped to slope and drain to the inside edge. If trail users start to slide sideways on a loose or slippery tread, they will then slide inward, away from the edge. This is typically used on switch backs.
2. Additional tread width: Widen the tread width in areas of limited sight lines or blind curves with an outside drop off.
3. Shoulder: Leave a vegetated strip on the outside edge to create a greater sense of safety and greater edge stability. The shoulder is lower than the tread and often slopes slightly down toward the outside edge (out-sloped). Drainage swales are optional. Shoulders are often used on trails built on abandoned railroad grades and road beds.
4. Constructed barrier: A curb, bump rail, low wall, fence, or guard rail can be used to provide edge protection on steep slopes, narrow treads, outside curves, hazardous drop offs, or when additional protection supports the trail purpose. If the barrier has suitable openings at tread level, the tread surface can be out-sloped.

1.

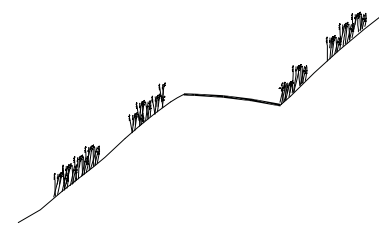

2.

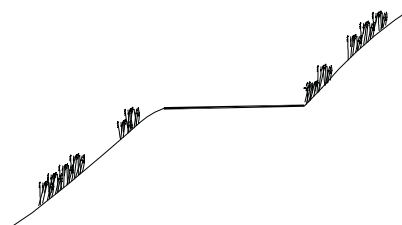

3.

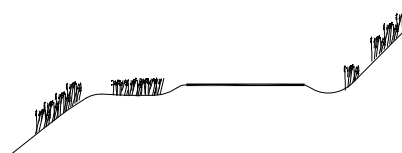

4.

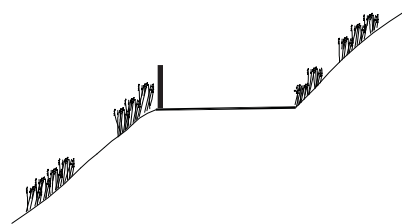

6.4 TRAIL SURFACING

The trail surface must be appropriate to the intended use and the environment in which the trail is built. In particular, the surface must be appropriate to the most demanding use intended for the trail. It must withstand natural stresses placed upon it including potential damage by freeze/thaw cycles, erosion and other natural conditions than might lead to the deterioration of the surface.

1. Harden trail surface when trail grade exceeds 15% slope.
2. Avoid using loose or sharp gravel as a trail surface or as a trail hardener. It is a hazard to many different types of users, non-motorized and motorized.
3. Raise the trail tread 7.5 - 15cm above surrounding grade to allow for subsurface drainage.
4. Red shale, limestone dust or finely crushed gravel make excellent trail surfaces that compact naturally.
5. Avoid wood fibre chips as they tend to retain moisture and don't stand up to sustained use.

Before Trail Hardening



After Trail Hardening



Photo credit: 'Pennsylvania Trail Design Manual'

Before Trail Hardening



After Trail Hardening
Alternative Trail Surfacing



7.0 TRAIL SIGNAGE

Signage is often necessary for identification, direction and regulation. It can also be a source of visual clutter. Trail Operators/Managers/Owners should use signage only where necessary and consider other methods of disseminating non-essential information. The most vital signs are those that mitigate risk. These include clear postings of rules governing the use of the trail and warning of hazards. It must be remembered that some trail users will be unable to read in either official language. Signs should include widely recognizable international symbols wherever possible.

It should be noted that way-finding elements do not necessarily require words or graphics in order to be effective. Simple elements such as color coded bollards can be used to mark individual trails or identify hazards.







Distance signs and emergency services signs are important for those with no prior knowledge of the trail. These can be located at trail heads or important junctions along the trail.

7.1 TYPICAL SIGNAGE ELEMENTS







Signs fall into 4 main categories: Regulatory, Cautionary, Informational and Educational. Before proceeding to design or purchase signage, Trail Operators/Managers/Owners must ensure that they have permission from the appropriate land authority or owner to place signs on the land.







The following sign symbol tables are taken from the 'Sign Design Guideline' manual prepared by the International Association of Snowmobile Administrators (IASA). These are general examples of signage used along trails in Alberta. Please check to ensure that your signage conforms with the local signage standards for the specific area that the trail is located in.

EXAMPLES OF REGULATORY SIGNAGE:









Typical Design	Name and Use	Usual Characteristics
	STOP Instructs riders to bring their vehicle to a complete stop before proceeding with caution.	0.3x 0.3m Octagon. Red background with white reflective lettering.
	YIELD Instructs riders to yield the right-of-way to vehicles traveling on the other trail.	0.3x 0.3m Triangle. Red and reflective white background, with red lettering.
	SNOWMOBILING ALLOWED Identifies areas where snowmobiling is allowed.	0.3x 0.3m Square. White background, black graphic, green circle – not reflective.
	NO ATV'S or TRAIL BIKES Identifies areas where ATV's or Trail Bikes are not allowed.	0.3x 0.3m Square. White background, black graphic, red circle – not reflective.
	SPEED LIMIT Reminds riders not to exceed the speed limit as indicated.	0.2x 0.3m Rectangle. White background, black graphic and black lettering.
	ONE WAY Identifies sections on the trail where vehicles may travel in one direction only.	0.2x 0.3m Rectangle. White background, black graphic and black lettering.
	OTHER REGULATORY SIGNS Other regulatory signs may be developed as necessary.	0.2x 0.3m Rectangle. White background and black lettering.

EXAMPLES OF CAUTIONARY SIGNAGE:





Typical Design	Name and Use	Usual Characteristics
	STOP AHEAD Informs riders they are approaching a stop sign.	0.3x 0.3m Diamond. Yellow background, red octagon and black arrow.
	CAUTION Use this sign to warn of a hazard when no specific sign is available for that purpose.	0.3x 0.3m Diamond. Yellow background and black lettering.
	SLOW Instructs riders to temporarily slow their vehicles.	0.3x 0.3m Diamond. Yellow background and black lettering.
	RIGHT OR LEFT TURN Informs the rider that the trail ahead makes a significant change in direction.	0.3x 0.3m Diamond. Yellow background and black graphic.
	GATE AHEAD Informs riders they are approaching a gate across the trail.	0.3x 0.3m Diamond. Yellow background and black lettering.
	JUNCTION AHEAD Informs riders they are approaching a trail intersection.	0.3x 0.3m Diamond. Yellow background and black lettering.

Typical Design	Name and Use	Usual Characteristics
	WINDING TRAIL Informs riders they are approaching a series of curves.	0.3x 0.3m Diamond. Yellow background and black graphic.
	OBJECT MARKER Identifies a fixed object at the side of the trail. Stripes slope down toward the trail. Used when any object narrows the normal width of the trail. See Figure 4.3 on page 100.	0.3x 0.3m Diamond. Yellow background and black graphic.
	CHEVRON ALIGNMENT SIGN Identifies a sharp turn and provides additional guidance.	0.3x 0.3m Diamond. Yellow background and black graphic.
	BRIDGE AHEAD Informs the rider that they are approaching a bridge that is narrower than the trail	0.3x 0.3m Diamond. Yellow background, black graphic and black lettering.
	BUMP Informs riders they are approaching a spot that is abruptly higher or lower than the rest of the trail.	0.3x 0.3m Diamond. Yellow background, black graphic and black lettering.
	STEEP HILL Informs riders they are approaching a section of the trail with an exceptionally steep grade.	0.3x 0.3m Diamond. Yellow background, black graphic and black lettering.
	RIGHT HAIRPIN TURN Informs riders they are approaching a sharp right hand turn of or close to 180 degrees.	0.3x 0.3m Diamond. Yellow background and black graphic.

EXAMPLES OF INFORMATIONAL SIGNAGE:

SIGN	NAME AND USE	PHYSICAL CHARACTERISTICS
	CLOSED TRAIL Informs rider that the trail is closed and should not be used.	300 x 150 mm rectangle. White background, black lettering.
	CLUB HOUSE Informs riders of the location of a club house.	300 x 300 mm square. White background, black graphics and lettering.
	DETOUR Informs riders that the trail has been temporarily re-routed.	300 x 300 mm square. White background, black graphics and lettering.
	FIRST AID Informs riders of the availability of first aid.	300 x 300 mm square. White background, red graphics.
	TELEPHONE Informs riders of the availability of a telephone.	300 x 300 mm square. White background, blue graphics.
	FUEL Informs riders of the availability of fuel.	300 x 300 mm square. White background, blue graphics.
	CAMPFIRE Informs riders of the availability of a fire pit.	300 x 300 mm square. White background, blue graphics.
	CROSS-COUNTRY SKI TRAIL Informs rider they are approaching a cross-country ski trail.	300 x 300 mm square. Blue background, white graphics.
	SNOW SHOE TRAIL Informs rider they are approaching a snow shoe trail.	300 x 300 mm square. Blue background, white graphics.

EXAMPLES OF EDUCATIONAL SIGNAGE:

SIGN	NAME AND USE	PHYSICAL CHARACTERISTICS
	RIDE SAFE RIDE SOBER Reminds the riders of proper riding etiquette.	300 x 300 mm square. White background, black lettering.
	MAKE TRACKS NOT TRASH Reminds the riders of proper riding etiquette.	300 x 300 mm square. Red background, white lettering.
	SLEDSMART STUPID HURTS Reminds the riders of proper riding etiquette.	300 x 300 mm square. Blue background, white lettering.
	SLOW DOWN NOW Reminder to riders to slow down in this area ahead. Use with other sign such as speed limit or quiet zone.	300 x 300 mm square. White background, red lettering.

7.3 ELEMENTS TO CONSIDER FOR SIGN DESIGN:

1. Do not group regulatory and warning signs together. Keep a distance of at least 25m between signs.
2. Informational signage should contain all emergency contact phone numbers as well as a phone number or website to direct trail related queries.
3. Group directional signs and bulletin boards together at all major trail heads, rest areas and trail parking lot locations.
4. Identify the approved trail use types with signage
5. Identify trail intersections using signage
6. Minimize negative messages on signs, because they are more prone to vandalism and theft. Utilize humor on signs wherever possible.
7. Educate trail users with gentle reminders instead of negative reminders.
8. Pavement marking should be used sparingly, as they can be slippery when wet, increasing the danger of slipping, as well as making stopping difficult. Never use them as an exclusive signing method.



2.



3.



4.



5.



6.



7.

9. Use trail etiquette signage to promote courtesy among trail users, thereby reducing user conflicts. The figures on the right are examples of "Yield" signage for trails.

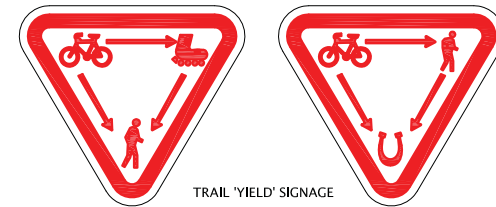

10. Where appropriate, clearly indicate trail uses that are not allowed during certain periods of the year.



11. Where possible, consider using a schedule for high conflict, multi or mixed use trails. The figure on the right illustrates an example of a horse and bike trail sharing schedule. This is also useful for managing horse, snowmobiles and OHV trails where conflict on these mixed use trails are much higher.

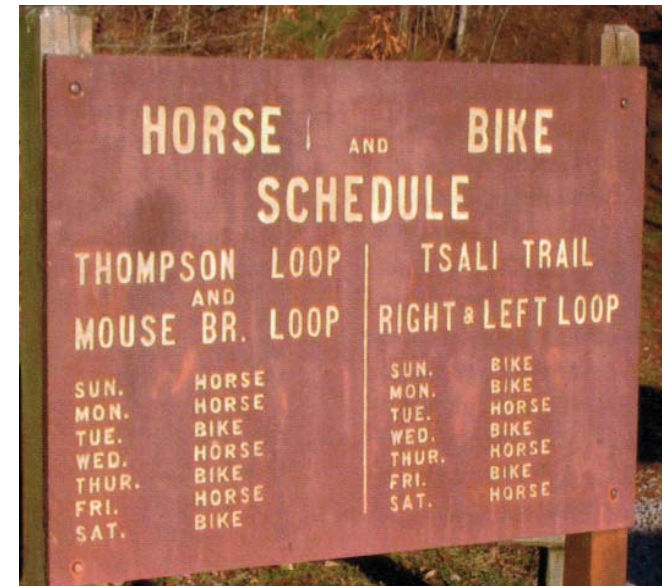

Photo credit: Department of Forestry, Clemson, South Carolina

12. Warn trail users about trail hazards:

1. Signage warning trail users about wildlife in the area.
2. Signage warning of fire hazards caused by motorized trail users.
3. Signage clearly communicating trail uses that are not allowed.



13. Close trails if necessary if trail hazards become too great a risk for trail users to use the trail.

The following are examples of circumstances of high risk:

- Fire hazards.
- Dangerous wildlife wandering too closely to trails.
- Severe weather conditions.
- Severely eroded trails, washed out trail infrastructure and large fallen trees.

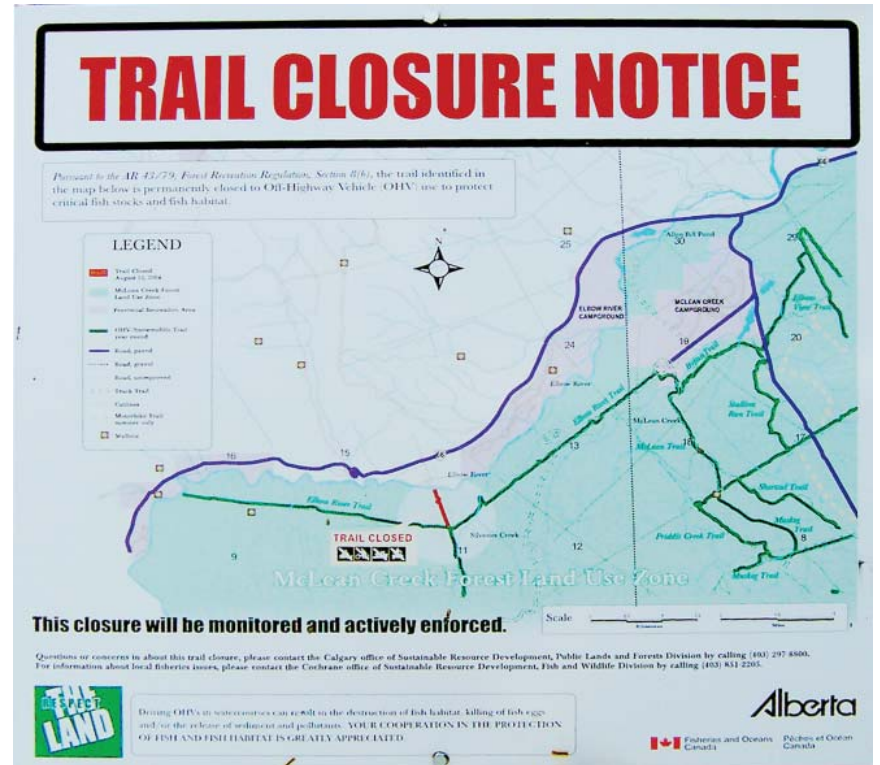

7.3 SIGNAGE PLACEMENT REQUIREMENTS

Signs must be placed so that they are clearly visible but in positions that do not impede traffic on the trail or represent a hazard to users. If a sign warns of a hazard, it must be placed sufficiently in advance of the hazard to allow the user to react appropriately. The illustrations on this page are taken from the 'Sign Design Guideline' manual prepared by the International Association of Snowmobile Administrators (IASA).

1. The top right figure illustrates the dimensional requirements for trail signage placement on non-motorized trails.
2. The bottom right figures illustrates the dimensional requirements for trail signage placement on motorized trails.
3. The bottom left figures illustrates the right and wrong way to orientate a sign on motorized trails.

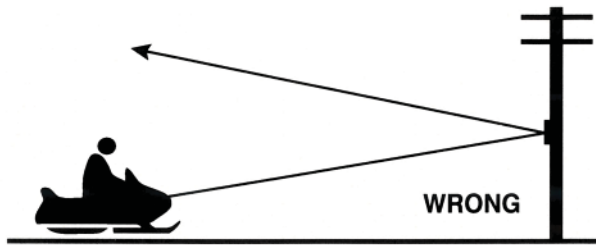
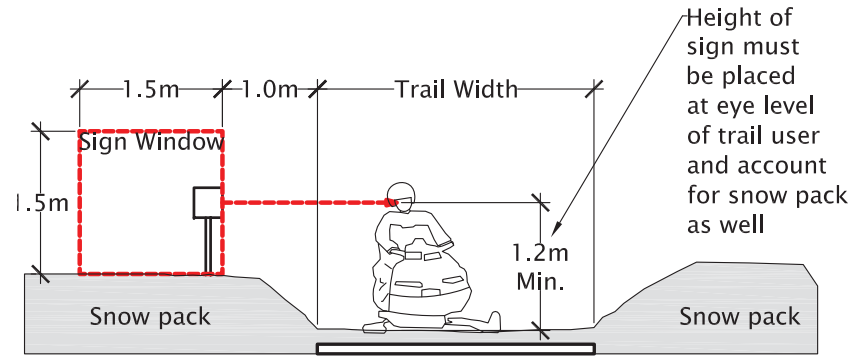
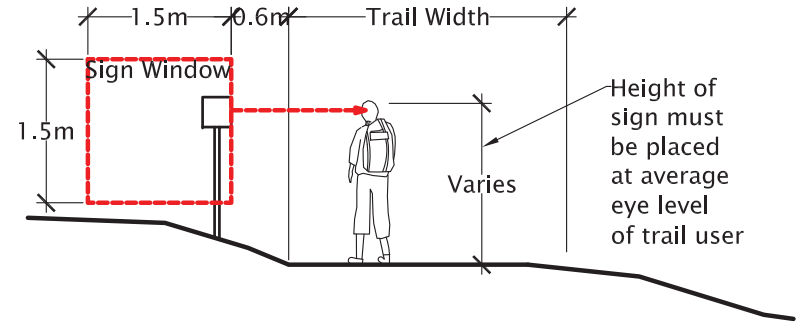

- a. Signs placed too high do not reflect headlight beams back to the rider.

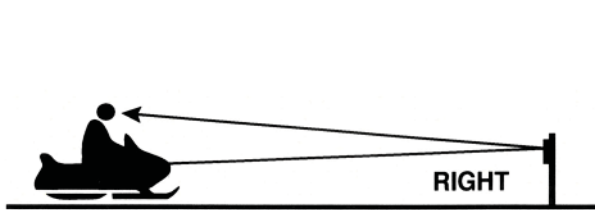

- b. Signs placed at rider's eye level reflect back correctly and are much easier to see.

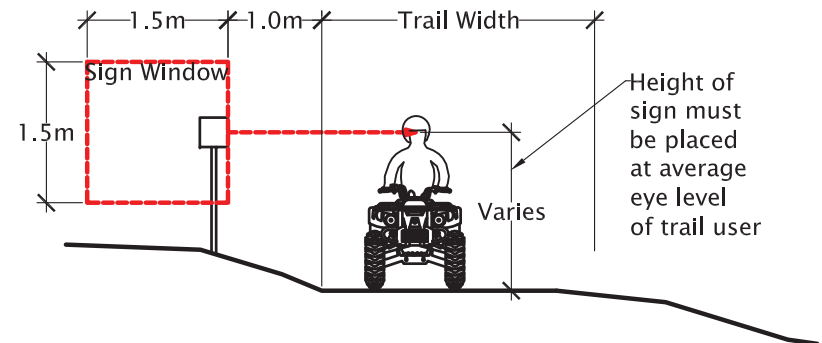

7.4 TYPICAL TRAIL SIGNAGE DIFFICULTY RATING SYSTEM FOR MOUNTAIN BIKING AND CROSS COUNTRY SKI TRAILS:

Where there are recognized difficulty levels associated with different types of trails, these should be clearly posted on signs at the entry points. It is vital that users understand the level of challenge represented by the trail they are preparing to use.

1. A trail difficulty rating system is commonly used to help mountain bikers navigate trails according to their experience and fitness level, thereby reducing the risk of unexpected injury due to lack of experience on the type of trail. The figures below show the common symbols used to identify the different difficulty ratings of a trail. Signs can be erected following this system of symbols.
2. Similar symbols are commonly used for downhill ski trails, and can also be useful for cross country ski trails too.



7.5 SIGNAGE VIEWING DISTANCES

The type of trail use will dictate the typical viewing distance for a sign. This in turn will influence the layout and design of the sign. In general, the necessary viewing distance increases as the average speed of the trail user increases. Any sign should be readable from a distance equal to, or greater than the typical stopping distance of the user. Legibility is affected by typical light levels, the size of the font and/or icons used on the sign, the contrast between the lettering and the sign background, and the clarity of the sign used. Trail Operators/Managers/Owners should consider using the approved standards for roadways with equivalent speed limits.

Cyclist and Mountain Bikers:

Minimum viewing distances for Stop signs: Stop signs should be visible from 40m. Where a trail intersects a road, stop signs should be visible from 60m. Warning signage should be placed no less than 35m from intersections.

Providing proper signage alerts riders to dismount when crossing narrow bridges, entering tunnels or culverts, as well as yielding to hikers or equestrians.

Ensure there is adequate signage at key locations, such as trail heads, junctions, and hazardous areas.

Snowmobiles (Trail requirements are the same for both single and double occupancy snowmobiles):

1. The following table displays the caution signage sighting distance for snowmobilers.

Minimum Posting Distance for Caution Signs for SNOWMOBILES

Design Speed (Km/Hr)	Stopping Sight Distances
30	* m
40	* m
50	55 m
55	70 m
65	90 m
70	100 m
80	130 m
90	150 m

* No suggested minimum distance recommended. At these speeds, sign location depends on physical conditions at the site

2. Provide proper trail etiquette signage as well as ample warning signs at intersections.

OHV – Off Highway Vehicles:

The following table displays the caution signage sighting distance for motorized recreational vehicles on motorized trails.

Minimum Posting Distance for Caution Signs

Design Speed (Km/Hr)	Stopping Sight Distances Flat Grade	Stopping Sight Distances Uphill Grade - 15% max	Stopping Sight Distances Downhill Grade - 15% max
10	6 m	6 m	6m
15	15 m	15 m	15 m
25	25 m	20 m	30 m
30	35 m	30 m	40 m
40	45 m	40 m	60 m
50	60 m	50 m	80 m
55	75 m	65 m	100 m
65	90 m	80 m	130 m
70	100 m	90 m	150 m

** All stopping distances shown in this table are based on a brake reaction time of 2.5seconds

The figure to the right and on the following two pages illustrate a variety of common trail locations where signs are needed. They also show where to place these signs.

The illustrations are taken from the 'Sign Design Guideline' manual prepared by the International Association of Snowmobile Administrators (IASA).

1. Warning signage and adequate sighting distances at road crossings.

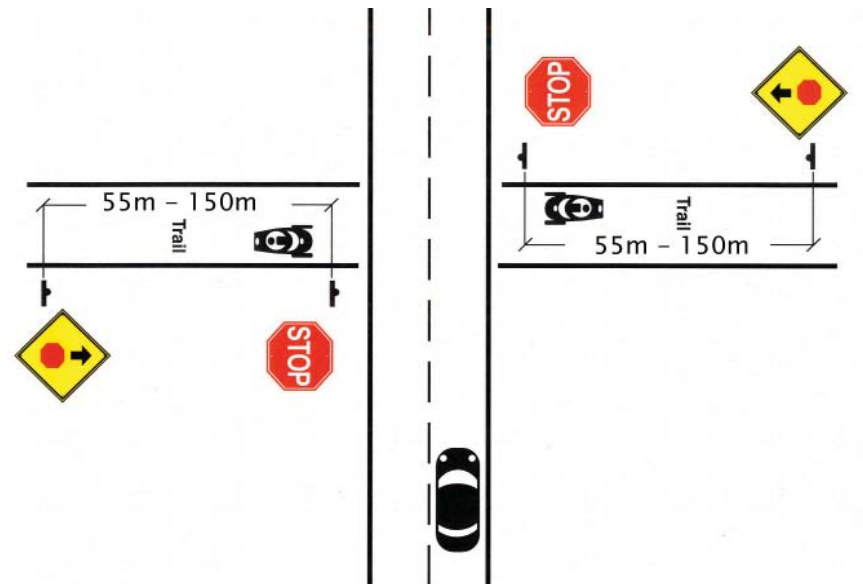

2. Warning signage and adequate sighting distances at trail intersections.

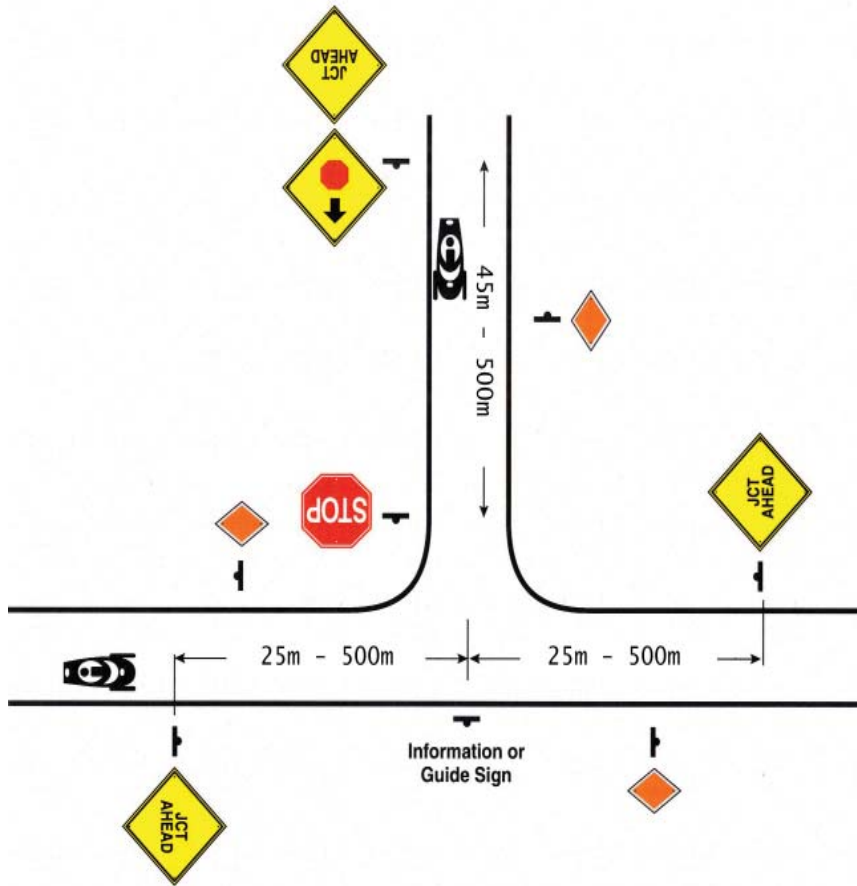

3. Warning signage and adequate sighting distances at bridge crossings.

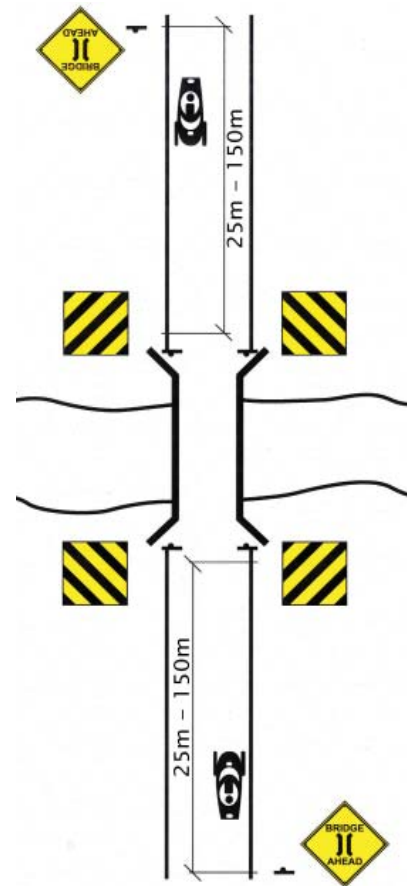

4. Warning signage at bumps.

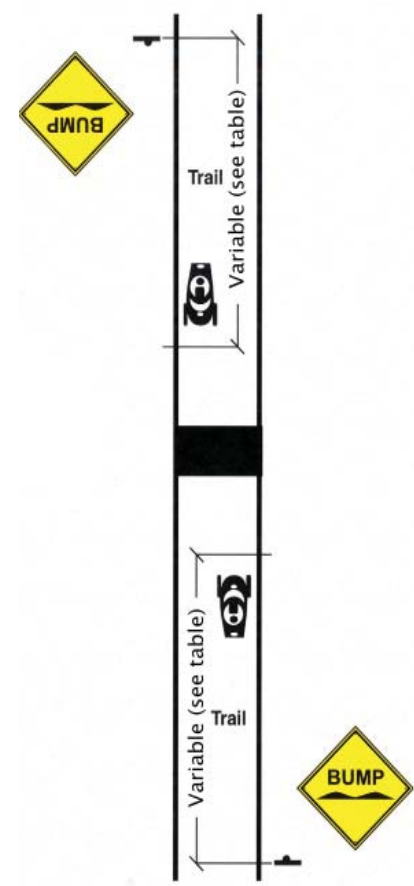

5. Warning signage and adequate sighting distances at curves and tight turns.

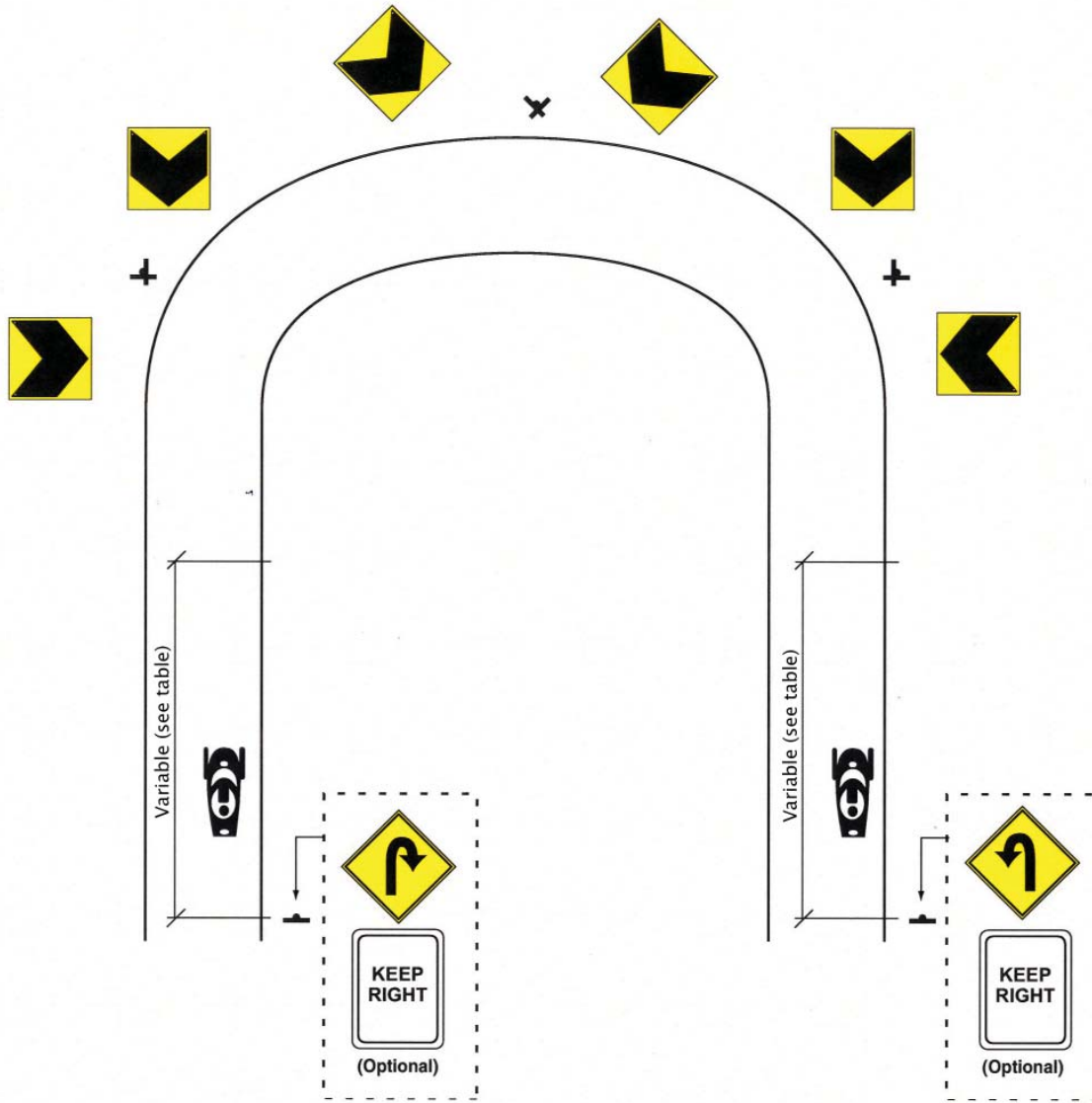

6. Warning signage and adequate sighting distances around sharp bends.

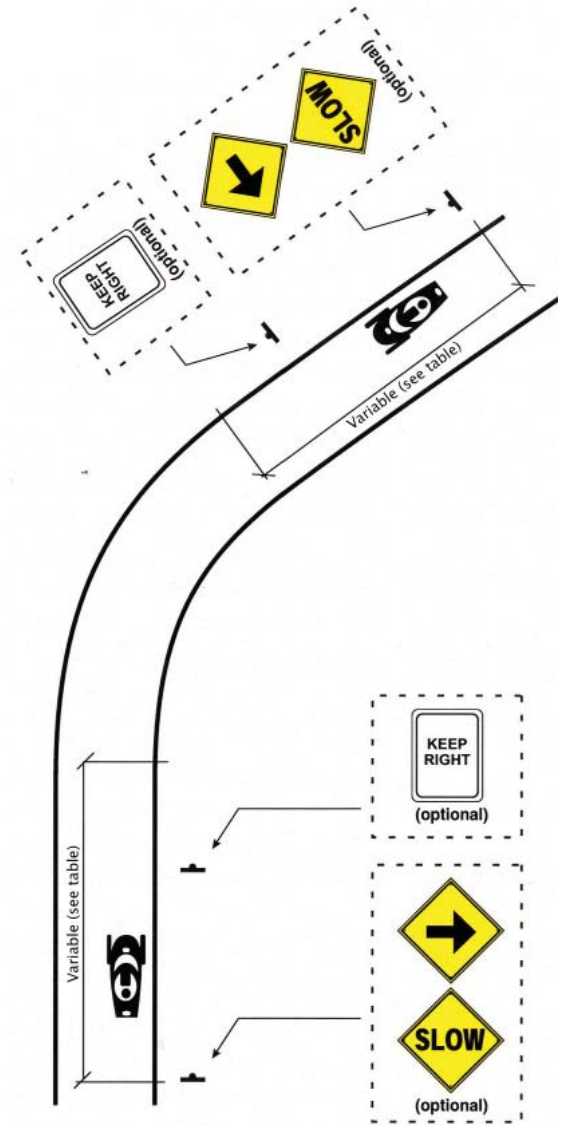

8.0 WATER CROSSINGS

Trail Operators/Managers should consider the development of any water crossing with the owners utmost care. There are three principle issues involved in all water crossing; safety, ecology and utility.



1. Utility: This is the simple requirement for the crossing to meet the needs of the intended users. In general, crossing should not be over built as this creates greater disruption and expense than necessary. They should be constructed based on accepted standards. All but the most modest crossings will require professional design services from a structural engineer or the use of pre-engineered bridge systems. Crossings may be subject to provincial and local building codes as well as standards issued by applicable OHV associations. The most rigorous applicable standard should guide design of the crossing. Crossings may include culverts, corduroy trails, boardwalks and bridges. Failure to properly design or construct any crossing can lead to substantial financial liability arising from greater maintenance and/or replacement costs. Substandard design or construction can also lead to complete or partial failure of the crossing resulting in potential serious injury or death.

2. Ecology: Streams, rivers, ponds and wetlands are ecologically sensitive areas. Trail Operators/Managers/Owners must be aware of local environment protection regulations and conform to their requirements. These regulations may place limitations on the location, nature and allowable uses of a crossing. There may also be requirements with respect to the materials to be used for construction, the time periods within which construction can occur and the required maintenance after construction. It may also be required to construct barriers to restrict user access to watercourses in the area of the crossings either for safety reasons or for environmental protection. Failure to comply with environmental regulations can result in substantial legal and financial liability.

3. Safety: Aside from the potential for failure of the crossing as noted above, there are ongoing safety concerns relating to the general operation of the crossing. Crossings must offer a stable walking surface as a basic minimum, suspension bridges are stable in the sense that they provide a structurally sound walking surface. Where there is a substantial risk of slipping or falling off the crossing or where it is mandated by applicable regulation, a suitable safety barrier must be provided. The crossing must be constructed of materials that are suitable for the intended purpose and will prove durable under use over long periods of time.

The following are key considerations when designing and constructing bridges:

- a. Where the crossing creates a fall distance of greater than 0.45 meters or where hazardous conditions such as sharp stones exist below the crossing, guard rails should be provided conforming to local standards. Note that guard rail design will vary depending on the type of use on the trail. Equestrian bridges require different standards than do cyclists or pedestrians.

- b. The edges of covered culvert crossings represent a fall hazard. Where no head wall or guard rail is provided, the steep slopes down to the water course can be treacherous. Where guard rails are not used, a shoulder on each side of the crossing should be provided. The width should be not less than 25% of the width of the trail surface. It is desirable to construct the shoulders using a material that has a contrasting colour or texture top to the trail surfacing material. Many culverts today are made of plastic.
- c. Crossings represent confined spaces where users cannot move aside to make way for others as may be possible at other points along the trail. The potential for collisions and conflicts between user groups is therefore greater at crossings. Provide a straight section of trail on either side of all water crossings that is equal to the average stopping distance for the intended users. The intention is to provide sufficient distance to allow a user to stop short of the crossing in the event that the crossing is blocked, washed out or otherwise compromised. Speed control measures should be considered where wheeled vehicles are in use.
- d. Wooden decks are prone to become slippery due to water, ice and algae, particularly as they are worn smooth by traffic. Where wood decks are used, consider methods of maintaining a non-slip finish and post signs warning of slippery conditions.
- e. Where the trail users travel at significant speed, such as is common with cyclists and motorized recreationalists, do not use bridges that incorporate grade change in their design. In particular, hump backed bridges can represent a significant hazard as trail users coming from opposite directions cannot see each other until they near the top of the hump, thus their braking reaction times may be delayed increasing the chances of collisions.
- f. Avoid unprotected approaches to crossings. Use vegetation or guard rails to direct riders onto the crossing.

8.1 PERMANENT CROSSINGS

Permanent crossing are designed to be used for a period of two years or more. These crossing include timber bridges, steel/ concrete bridges, and culverts. These types of crossing need to be authorized by licenses/ permits issued by Sustainable Resources Development on public lands and the Water Resources Administration Division of Alberta Environment, the Department of Fisheries and Oceans as well as authorization from the land owner. Trail Operators/Managers/Owners should acquaint themselves with all applicable regulation, provincial and local building codes and proceed accordingly.

All crossings must be designed by a structural engineer to support the weight, vibration and stresses imposed by the intended user group. This can be achieved by engaging the services of a professional structural engineer or through the purchase of a pre-engineered structure from a reputable firm.



An example of a well built, structurally sound, permanent bridge crossing.

8.2 TEMPORARY CROSSINGS

These crossings are typically used on a seasonal basis. Crossings include, fords, log bridges, snow and ice bridges, timber bridges, portable bridges, and culverts. Crossings used during the winter season must be removed before the spring break up. These bridges by their nature are temporary. Extended use of these crossings, and failure to remove the bridges at their scheduled times can pose serious danger to users who are unaware of the crossing's temporary nature.

8.3 BRIDGE MAINTENANCE

Trail Operators/Managers/Owners must consider that crossings, in particular culverts, bridges and boardwalks, may be subject to unique problems.

Ice may form on bridge decks at times when the trail is otherwise free of ice, creating an unexpected hazard for unwary users. Wooden walking surfaces are prone to attack by algae, making them slick and resulting in a fall hazard. Washouts can occur frequently in some areas. Appropriate warning signs and maintenance practices should be considered to mitigate these problems. Once a bridge or culvert has been installed, a regular maintenance and inspection program should be conducted and documented. Bridges should be inspected at least once a year. Maintenance ensures the operation and safety of a crossing and controls erosion. Occasional remedial work also helps reduce liability.



An old bridge that has fallen to disrepair. This is a hazard and a liability.



An example of a temporary log bridge.



An example of a temporary portable wood bridge, also known as a 'puncheon'.

8.4 EQUESTRIAN BRIDGES

Equestrian bridges are constructed only when it is not possible for a horse to navigate through a body of water safely. Bridges pose an interesting challenge for most horses. Due to their high center of gravity and fear of falling, horses are easily spooked and can pose a great danger to the rider by throwing the rider off into the water. If a bridge is necessary, then they should be constructed narrow and have high railings. No passing is allowed on bridges used by horses. Post "No passing" signage as well as signage to let the riders know that they should dismount and lead their horses over the bridge.

Key design considerations for equestrian bridges are:

1. Bridge railings should extend 1.4m above the deck of the bridge.
2. The maximum width of the bridge is 1.5m wide. (measured from inside curbing to inside curbing). Keep the minimum depth of curbing to no less than 0.18m. The typical 0.15m is not sufficient. Horses need the bulk of the edges to feel safe. Bridges should also have a non-skid surface.
3. Bridge railings should be built out of a strong sturdy material. Chamfer all edges of protruding wood post, so that no sharp edges exist.
4. Avoid unprotected approaches on either side of the bridge opening. Use vegetation or wing walls to encourage horse direction.
5. Bridges should not have slope of any degree.



1.



2.



3.

A "no sharp edges" design for bridge railings and end posts. (Photo by G.W. Wood.)



4.

Unprotected approach at bridge arrivals, are not allowed for horse bridges.

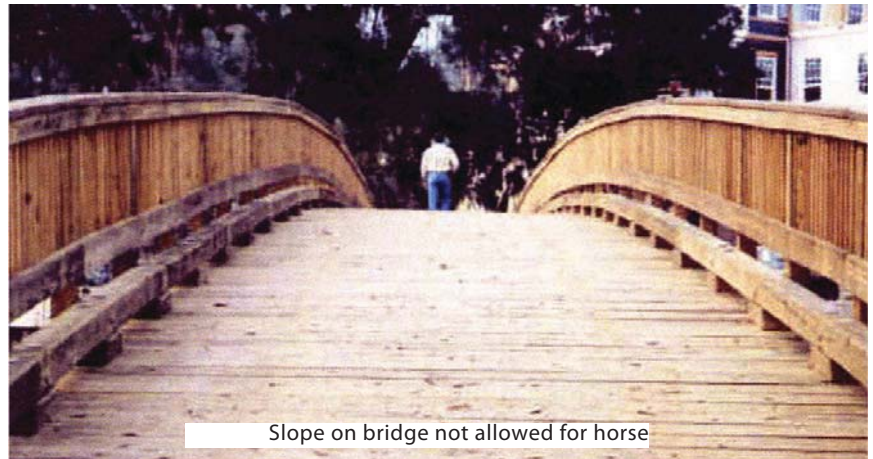

5.

Slope on bridge not allowed for horse

Photo Credits: Designing Shared-Use Trails to Include Equestrians - Anne M. O'Dell

9.0 TRAIL OPERATIONS

9.1 TRAIL MANAGEMENT

If the Trail Operators involvement extends into management of a trail, they must understand that trails are an ongoing responsibility. The best design and construction practices will not compensate for operational deficiencies. In order for a trail to remain functional and safe, it must be properly managed. While management is not necessarily an onerous duty, it is a constant requirement.

Trail Operators/Managers/Owners are responsible for defining and implementing appropriate policies regarding all use, user conflict resolution, operational procedures, user complaint response, emergency preparedness, and similar issues. If anything does happen on the trail, the Trail Operators should have a defined policy and response ready for implementation. Improper management practices open the way for a host of potential problems and liabilities.

9.2 TRAIL SAFETY MANAGEMENT

9.2.1 Trail Safety Plans

It is important for trail operators and managers to have some sort of plan to pre-empt and find solutions to deal with unexpected events and accidents that may happen on the trail. This could include events such as avalanches, wildfires, industrial accidents and dealing with wildlife in the area.

The following are trail safety polices a not-for-profit organization should consider implementing as part of their organizational plan.

- Prepare an emergency plan. The plan should pre-empt potential emergencies, such as fire hazards or removal of badly injured users. Have a good trail map that clearly marks the beginning and end of trails access routes. Ensure that during the planning and design stage, that trail heads are easily accessible and recognizable to emergency personnel. Trail heads should have a large enough space to accommodate an emergency vehicle. As well, ensure that emergency contact information is readily available to users on the club's website, trail heads, and on any trail information signage.
- For extreme or long distance trails, there should be procedures to monitor users. For example having a sign-in sheet, with expected day and time of return, and a safety check list.
- Provide adequate signage at all trail heads explaining trail etiquette, trail hazards and trail conditions. Signage may include information such as months of use, wildlife and fire hazards and types of unfavorable weather conditions that deem the trail unsafe. For examples of these types of signage, please refer to page 50 - 52 of this document.

9.2.2 Avalanche Safety Management Plan

Trail Operators/Managers/Owners should have a well laid out avalanche safety management plan if they plan to build or allow trails located along or across avalanche fall lines in mountainous regions, above the tree line and in bowl areas.

One of the most important steps Trail Operators/Managers/Owners should take is to make all trail users aware of the avalanche danger. This can be done through signage, websites, trail user meetings, at visitor information centers and trail heads.

For any potential avalanche areas, sign(s) should be placed on the trail indicating the level of risk apparent from avalanche. The five risk levels are defined by the Canadian Avalanche Centre standards at www.avalanche.ca. These risk levels could require daily, weekly or monthly updates, as appropriate.

Below are measures a Trail Operator/Manager/Owner responsible for a trail near a bowl or avalanche area should consider implementing for risk management of avalanches:

- Contact an Avalanche consultant and get an assessment of the area's baseline structure and its potential to create damage – a list of these consultants is available at www.avalanche.ca/caa/members/qualifiedavalanche-planners.
- Based on the avalanche consultant's report – the Trail Operator/Manager/Owner will need to develop an Avalanche safety plan. This plan will provide an operating protocol outlining the steps to manage the risk of avalanche.
- The Trail Operator/Manager/Owner needs to coordinate with the Canadian Avalanche Center to develop a working partnership so the sharing of collected environmental and climatic conditions within the local area can proceed. This information would be forwarded on a regular basis to the Canadian Avalanche Center where interpretive models have been developed to determine the level of risk of avalanche for that area and can be communicated to all necessary stakeholders.

- Should the risk level be at a threshold level the Trail Operator/Manager/Owner needs to carry out appropriate actions depending on their legislative authority on the trail including:
 - Signs
 - Closing trails
 - Gates on access roads
- The Trail Operator/Manager/Owner may also consider getting some of their own staff or volunteers qualified in Avalanche training. More information on this can be obtained from the Avalanche consultant through the Canadian Avalanche Centre.

The Canadian Avalanche Centre offers training courses for Operators needing to become more adept on this topic. These courses can be found at www.avalanche.ca/caa/training/training-flowchart.

Backcountry operations should incorporate the following risk mitigation plans into their avalanche safety management plans.

- Operational Safety Plans
- Intermittent Avalanche Control
- Route Selection by Professional Guides

10.0 TRAIL VOLUNTEERS AND STEWARDSHIP

Trails have varying degrees of maintenance required. Some trails require more monitoring than others. For many Trail Operators/Managers/Owners this task can seem daunting given the number of trails and/or distance the trail covers. To accomplish this task successfully, Trail Operators/Managers/Owners need the help of trail stewards.

Typically, trail stewards are volunteers, people that use the trail and/or have a vested interest in maintaining the longevity of the trail. It is important for Trail Operators/Managers/Owners to provide a well managed and safe environment for volunteers to operate in as they are a key component to the long term survival of any trail.

Often the task of trail building is more difficult than it appears to be. Trail Operators/Managers/Owners should consider using the services of a professional trail building crew. These crews are experienced and understand the nuances of trail building. A properly built trail has lower maintenance cost, causes less damage to the environment and has lower user conflicts.

10.1 MANAGEMENT OF VOLUNTEERS

Below are recommended best practices for Trail Operators/Managers/Owners to consider adopting as organizational policies. Implementing these or similar measures will help to minimize the risk that volunteers could bring to themselves or to their organization. A well managed volunteer organization will result in smoother and safer trail maintenance operations.

Trail Operators/Managers/Owners should layout policies and procedures which provide structure for the maintenance program and guidance for the volunteers including:

- Confidentiality Agreement
- Alcohol/drug use at the work site
- No Discrimination Policy
- No Harassment Policy
- Grievance Procedure

- Termination Procedure
- Liability Release
- Safety Policy

Trail Operators/ Managers/ Owners should also identify potential risks for volunteer jobs. They need to clearly define:

- Job Descriptions
- What skills are needed for this work?
- What equipment?
- What are the physical demands the work will place on the volunteer?
- Is there a minimum fitness level required to perform the job successfully?
- What dangers might the volunteer encounter - use of dangerous equipment, steep terrain, wild life (such as bears, moose and cougars), falling trees, extreme climate conditions?

Trail Operators/ Managers/ Owners should take precautions to avoid obvious and unforeseen risks that volunteers may encounter.

- Establish minimum health requirements appropriate to volunteer work.
- Recruit, screen and place volunteers with appropriate skills and physical capability for the work.
- Provide training and supervision on correct use of equipment at the onset of work even if the volunteer states they are competent in using equipment.
- Require or provide appropriate safety equipment items such as: safety glasses, ear protection, chain saw pants and work gloves and safety boots.
- Encourage volunteers to self-identify risks you may have overlooked and communicate them to you and the group.

- Write volunteer position descriptions that specify skills needed to perform and have the volunteers read and sign the description (to reduce liability).
- Provide written procedures and protocol for situations that involve risk.
- Provide written fact sheets regarding hazards and safety precautions.
- Evaluating your volunteers and your volunteer program on a periodic or annual basis is critical to sustaining an effective and efficient program. The evaluation process should be tailored to your program and to the volunteer tasks. Questions to evaluate your program may include:
 - a. Is our volunteer program meeting our goals; how is it contributing to achieving our organization’s mission?
 - b. How are volunteers contributing to achieving our strategic goals and mission?
 - c. What is our program costing the organization (staff time, expenses, etc.)?
 - d. What are the non-tangible benefits of our volunteer program?

Please refer to Appendix A - J for sample forms that a Trail Operator/Manager/Owner might find useful.

11.0 TRAIL MAINTENANCE

The best trail maintenance is preventative. This means replacing worn components and repairing damaged areas before they fail entirely. This proactive approach will greatly reduce the Trail Operators/Managers/Owners’ exposure to liability. If the trail has been properly designed and constructed, maintenance should be a routine action that returns the trail to its original design condition.

11.1 GENERAL TRAIL MAINTENANCE BEST PRACTICES

The following are common due diligence maintenance practices that a Trail Operator/Manager/Owner can do to mitigate risk on trails.

1. Perform regular inspections on the trail. This includes but is not limited to: checking for damaged gates and signage, erosion problems, washouts, fallen trees or any trail obstructions. Maintain detailed and on-going trail maintenance records. Refer to Appendix E for a sample “Trail Inspection Report”
3. Monitor weather conditions and any unexpected conditions that might temporarily compromise the stability or availability of the trail. Post temporary warning signage updating users on weather conditions and their impact on the trail.
4. Where possible, close trail when severe weather conditions deem the trail unsafe for users.
5. Where practical, close trail and place warning signs when dangerous wildlife is in close proximity of the trail.
6. When performing trail maintenance, a Trail Operator/Manager/Owner should take the following into consideration:
 - Have adequate flag men.
 - Provide warning signage to let trail users know construction/maintenance is in progress.
 - Ensure that workers are trained and well equipped to perform the tasks undertaken.
 - Place a warning on a website so work won’t be a surprise to trail users.

12.0 SPECIAL TRAILS

12.1 VIA FERRATA



Via Ferrata is Italian for “via the iron rung”. Via Ferrata is a mountain route which is equipped with fixed cables, stemples, ladders, and bridges. The use of these allows otherwise isolated routes to be joined to create longer routes which are accessible to people with a wide range of climbing abilities. Walkers and climbers can follow Via Ferratas without needing to use their own ropes and belays, and without the risks associated with unprotected scrambling and climbing. They are found in a number of European countries. Via Ferratas are also found in a few places in the United States and Canada (including Alberta).

While Via Ferrata is similar to rock climbing the major difference is that the fall factor, which in climbing can never by definition exceed 2, can in Via Ferrata be much higher. (Fall factor is the ratio of the length a climber falls before his rope begins to stretch and the amount of rope available to absorb the energy of the fall. In climbing terms: the length of an arrested fall cannot exceed two times the length of the rope.)

These high fall factors are possible in Via Ferratas because the length of rope between harness and carabiner is short and fixed, while the distance the climber can fall depends on the gaps between anchor points for the safety cable. The human body, as well as most items of climbing equipment, cannot withstand the forces associated with some of these higher fall factors and so a number of devices have been developed to act as shock absorbers or progressive brakes. Their function is to dissipate the energy of the fall while at the same time keeping the climber and equipment intact.

In spite of the perception of Via Ferrata as being more secure and safer than rock climbing, people are more likely to injure themselves if they do fall, partly because of these elevated fall factors and partly because there are often rungs, steps, pigtails, etc on which to land.

Via Ferrata's are not common in Alberta, though they do exist. Trail Operators / Managers / Owners contemplating a Via Ferrata must contact the land owner or authority for appropriate permissions. In most cases this would be Alberta Sustainable Resource Development. Those interested should also visit the following websites for more detail on Via Ferratas: www.coe.ca, www.acmg.ca, www.pc.gc.ca, and www.alpine-clubofcanada.ca

Via Ferratas are considered extreme trails and have high risk of a person falling and possible death. No trail user is allowed on these trails unless they have the explicit permission from the trail owner and/or operator.

Due to the extreme nature of the trail, Via Ferratas are only operated by a trail group with the approval of the land management authority in which it is located. These trail groups are often "for-profit" organizations, and they offer "guided ascents" that the public can sign up and pay a fee.

All Via Ferrata trail users must be led by a mountain guide certified by ACMG (Association of Canadian Mountain Guides). Certified ACMG guide(s) will lead the group through a safe and enjoyable climb.

Trail Operators/Managers/Owners should consult with the land owner/authority as well as an insurance specialist to find out what types or if any insurance coverage is necessary or even possible.

Most commonly there is extensive signage at the base of these trails indicating to the public that they are not for public use, and providing clear contact information on how to get in contact with the trail operator.

12.2 OTHER EXTREME TRAILS

This section of the document deals with the basic forms of extreme trails. They are comprised of high-marking, mountain climbing, ice climbing and rock climbing trails. The risks associated with slipping, falling, being buried by an avalanche and dying are extremely high and these risks cannot be borne or retained by anyone but the user themselves.

a. High-Marking



High-Marking and snow tracks.

High-Marking is the recreational maneuver of attempting to reach the highest point of a snow-covered mountain on a snowmobile. It is an activity in which the snowmobile tries to ride as far up a steep mountain slope as possible, then turn around and come back down the hill without getting stuck, rolling the snowmobile or losing power.

A high-mark begins when a snowmobiler leaves an established trail and fully accelerates; blazing a trail upward toward the summit of a snow-covered mountain face, ideally lying at a 30-45% grade. As the terrain gets steeper, the machine's acceleration slows down. At the apex of the elevation gained, the rider must sharply turn 180 degrees and descend the feature.

The height of the arching track left in the snow by a pioneering rider usually sparks competition within members of a rider's party, urging the rest to surpass the height of the original arch, thus initiating a competition. High marks vary in their degrees of difficulty depending on the pitch of a given ascent and conditions of the snow.

This activity is extremely dangerous and can involve serious personal injury, because optimum high-mark terrain is typically in areas where avalanche danger is extremely high and the rider's activities can trigger the avalanche itself, causing the rider to be buried in the ensuing snow slide.



The path of destruction of an avalanche.

According to American Council of Snowmobile Associations, "High-marking accounts for more than 63 percent of the avalanche fatalities involving snowmobilers in North America." High-marking should only be attempted by snowmobilers who are equipped with avalanche transceivers and accompanied by other riders capable of detecting a distress signal and rescuing a buried snowmobiler.

The dangers of the activity cannot be overstated. This is not an insurable activity, and Trail Operators/Managers/Owners should not endorse any part of this activity on designated trails.

b. Climbing



Free rope ascent up a mountain.

Dangers in mountaineering, rock and ice climbing can be divided into two categories:

1. Objective hazards that exist without regard to the climber's presence, such as rock-fall, avalanches and inclement weather.
2. Subjective hazards that relate only to factors introduced by the climber such as equipment failure and falls due to inattention, fatigue or inadequate technique. A route continually swept by avalanches and storms is said to have a high level of objective danger, whereas a technically far more difficult route that is relatively safe from these dangers may be regarded as objectively safer.

In all, climbers must concern themselves with the following dangers: falling rocks, falling ice, snow-avalanches, the climber falling, falls from ice slopes, falls down snow slopes, falls into crevasses and the dangers from altitude and weather.

Most extreme trails are located within the mountains of Canada's national parks. For more detail about how these trails are operated, please visit the website www.pc.gc.ca. The parks mountain safety website was created to provide users of the Mountain National Parks with information that will help them to travel safely in the back country of Banff, Yoho, Kootenay, Jasper, Mount Revelstoke, Glacier and Waterton Lakes National Parks. This is an effective way of communicating to a large group of potentially interested trail users throughout the world.

Trail developers who are contemplating an extreme trail on provincial lands must contact the appropriate land manager to obtain the proper approvals. In most cases this will be Alberta Sustainable Resources Development.

There are guided climbs (expeditions) led by different groups such as the Alpine Club of Canada (ACC). Please visit their website www.alpineclubofcanada.ca for more information. Some of these groups are "for-profit" organizations comprised of certified ACMG guides that, for a fee, will take interested individuals on mountain climbing expeditions. As well there are local rock and ice climbing clubs led by trained climbing professionals that will take interested individuals on rock/ice climbing expeditions.

In the Appendix section of this document, one can find forms regarding waiver administration, incident management and reporting that may help trail developers or managers contemplating operating an extreme trail. These are forms taken from the ACC and ACMG website, and is offered as information to the public.

Appendix I – Trip waivers - Any participant in activities sponsored by The Alpine Club of Canada is required to sign the Release of Liability, Waiver of All Possible Claims, and Assumption of Risk ("the Release"). The following forms are provided for section trip leaders to print out and trip participants to read and sign.

1. Waiver Admin Policy – How to manage those waivers
2. ACC Waiver Forms – Blank form
3. ACMG Waiver Form – Blank form

Appendix J – Incident Reporting - In the event of an accident, this is ACC's policy that any accident be reported to the ACC National Office if the trip was an ACC-sponsored activity

1. Field Accident Report
2. Incident Report Form

13.0 APPENDICIES

APPENDIX A - SAMPLE VOLUNTEER APPLICATION FORM

APPENDIX B - SAMPLE LIABILITY RELEASE FORM

APPENDIX C - SAMPLE SAFETY POLICY

APPENDIX D - SAMPLE SAFETY FACT SHEET

APPENDIX E - SAMPLE TRAIL RISK INSPECTION REPORT

APPENDIX F - SAMPLE TRAIL INCIDENT REPORT

APPENDIX G - SAMPLE TRAIL USE & INDEMNIFICATION AGREEMENT

APPENDIX H - AVALANCHE SAFETY PLANS

APPENDIX I - EXTREME TRAILS WAIVER POLICY AND FORMS

APPENDIX J - EXTREME TRAILS INCIDENT REPORTING FORMS

The sample forms included in this document are for informational purposes only. The Government of Alberta does not warrant that the use of these sample forms will adequately protect every organization, given the unique nature of each group.

APPENDIX A - SAMPLE VOLUNTEER APPLICATION FORM

Sample Volunteer Application

Volunteer Application Form

Please complete the application and return it to [organization name][mailing address]

Name: _____

Mailing Address: _____

Home Phone: _____ Work Phone: _____

Best time to contact you: _____ May we contact you at work? ()Yes () No

Employer/ School: _____

Occupation/ Course of Study: _____

Degree(s) or Certification(s): _____

Health Condition. Please indicate if you have any of the following conditions or other conditions we should be aware of in making your volunteer assignment:

_____ Asthma/ Shortness of Breath	_____ Emphysema
_____ Heath Conditions/ Bypass Surgery	_____ Hip/Knee Replacement
_____ Shoulder replacement/ problems	_____ Vertigo/Balance Problems

Have you volunteered with us before? ()Yes ()No

If yes, when and for which project? _____

Skills and Interest. Please place an **S** by your skills and an **I** by areas of interest.

_____ Fundraising Events	_____ Membership Outreach
_____ Event Organization	_____ Exhibit Preparation
_____ Grant Writing	_____ Youth Programs
_____ Office / Administrative Projects	_____ Volunteer Management
_____ Field Trip Leader	_____ Research/ Date Collection
_____ Creating Maps using GIS	_____ Preserve Stewardship
_____ Public Speaking	_____ Trail Building
_____ Graphic Design	_____ Invasive Weed Control
_____ Writing	_____ Using Heavy Tools
_____ Public Relations	

Additional special Skills I bring to the organization/ project include:

Availability:

Weekly Monthly Quarterly Periodically Call me

Weekdays Weekday Evenings Weekends Weekend Evenings

I am interested in volunteering for the [Organization Name] because :

Please select all that apply:

The types of volunteer opportunities I am interested in are:

One time only Short term: 1-3 months Occasional Long term: 6-12 months

I am looking for volunteer opportunities that will:

utilized my existing skills provide me an opportunity to learn new skills

provide me with an educational opportunity.

Personal or Professional References:

1. Name: _____

Relationship: _____

2. Name: _____

Relationship: _____

3. Name: _____

Relationship: _____

Have you ever been convicted of a misdemeanor? Yes No

Have you ever been convicted of a felony? Yes No

Thank you for your interest in [organization name]

We will contact you to learn more about your interest and discuss current volunteer opportunities

APPENDIX B - SAMPLE LIABILITY RELEASE FORM

Sample Liability Release

Sample is not legal advice. Have your organizations legal counsel review your liability release

WAIVER AND RELEASE AGREEMENT¹²

**THIS IS A RELEASE OF LIABILITY,
PLEASE READ CAREFULLY BEFORE SIGNING**

NAME:
ADDRESS:
CITY/STATE ZIP CODE:
PHONE (h) (w)
EMAIL

Are you registered as part of a group? ___ Yes ___ No If yes, what is the name of the group? _____

Are you under 18 years of age? ___ Yes ___ No If yes, what year were you born?

How did you hear about this project?

In return for receiving permission from _____ for allowing me to participate as a volunteer on the on _____, Project Description I agree to assume all risks of loss and injury that may arise out of my participation and I agree to waive any and all claims against and the other parties described below. I hereby release, and agree to indemnify and hold harmless _____ (Organization Name), project participants, and anyone else involved with this project and their respective agents, representatives, officers, employees, successors, assigns and insurers, hereinafter referred to collectively as "the Released Parties", from any and all liability, claims, demands or actions or causes of action whatsoever, arising out of damage, loss or injury to my person or property, whether anticipated or unanticipated, while participating in any of the activities contemplated by this agreement, whether such damage, loss, or injury results from the negligence of the Released Parties, their respective agents, officers, employees, successors, assigns and insurers or from some other cause. This release and agreement shall be binding upon me, my heirs, successors, assigns, administrators and executors.

I expressly acknowledge, represent and agree that expressly identifying and explicitly naming the respective agents, representatives, officers, employees, successors, assigns and insurers of the parties released, all of whom I intend to be released by this document, is a practical impossibility for the parties. I expressly acknowledge that, for good and valuable consideration, the terms "respective agents, representatives, officers, employees, successors, assigns, and insurers", however used in this Waiver and Release Agreement, are expressly and explicitly intended to

include all and each and every individual, person, firm, entity and corporation who are now, or at any time may have been included in the specifically listed categories.

I have read and understand the _____ project description related to this project. I realize that working on this project may involve risks and hazards, which may include, but are not limited to (1) the use of tools and other construction related equipment, (2) working around other participants who may not be accustomed to this type of labor or the tools and equipment associated with it, (3) working in mountainous, back country, or other urban or rural terrain that may be uneven, rocky and otherwise hazardous, (4) other risks and hazards that may be described in the project description. I am aware of these and other risks and hazards inherent in participating in this project and hereby assume sole responsibility for all such risks and hazards.

I _____ grant and other project sponsors permission to utilize my image in photographic recordings of the project, and I waive any right to claim compensation in exchange for participating in the project. I agree to abide by the rules and regulations of while participating in this project. I hereby acknowledge that I have read, understood, and voluntarily agreed to the foregoing waiver and release agreement.

Signature _____ Date: _____

Signature of parent or guardian if you are under 18 years of age:

Signature _____ Date: _____

Person to contact in case of an emergency:

Name: _____ Phone: _____

APPENDIX C - SAMPLE SAFETY POLICY

Sample Safety Policy

OAK RIDGES TRAIL ASSOCIATION (ORTA) SAFETY POLICY FOR TRAIL WORKERS¹³

1.0 INTRODUCTION

1.1 PURPOSE

The purpose of this policy is to ensure that volunteers and employees participating in the construction and maintenance of the Oak Ridges Trail do so in a safe manner, thereby minimizing risk of injury and associated liability to the ORTA and its officers.

It is ORTA's duty to adopt reasonable standards, and to ensure that they are being applied on the Trail. All volunteers and employees shall be made aware of this policy.

1.2 TRAIL WORK

- (a) Trail workers should be made aware of the hazards and risks involved in the work to be done.
- (b) Trail workers participating in trail building or maintenance should sign an acknowledgement of risk and waiver of liability form (Appendix A).
- (c) Written documentation should be prepared for the project, describing the work; when, where, who is involved, expectations. This should be filed along with the above-mentioned waiver forms.
- (d) Trail work must only be done at the instruction of a Trail Captain or Chapter Chair. The Trail Captain, Chapter Chair or their designate shall be present and undertake responsibility for all trail work.
- (e) New trail construction must be done with the landowner's prior knowledge and approval including approval of the specific details of the physical construction planned.
- (f) Maintenance of the existing trail must be conducted within the restrictions and limitations specified in any land use agreement signed by the association and the landowner.
- (g) Trail building and maintenance should be done only by those who have been trained and equipped for the tasks at hand.
- (h) Trail workers should not work alone in situations involving the use of power equipment, climbing, or other increased risk activities.
- (i) Power equipment (e.g. chainsaws, brush cutters) must only be operated by trained persons or those whose experience with such machinery can be verified (examples: groundskeeper, farmer). Power equipment must never be used by inexperienced operators.
- (j) Safety equipment must be worn at all times when using powered equipment.

(k) When repairs are required to the trail, the Trail Captain or Chapter Chair should determine who has the primary responsibility to make the repair. For example, removal of a large fallen tree may be the responsibility of a conservation authority, on whose land the trail exists, and which has the trained and experienced staff to remove the tree.

2.0 USE OF EQUIPMENT

2.1 SAFETY

(a) Power equipment includes, but is not limited to, chain saws, string trimmers, brush cutters, and any other machinery which is powered by gasoline or electricity. Battery-operated equipment is not included.

(b) All operators of power equipment shall be properly trained in the safe use of the equipment (see Training).

(c) All operators of power equipment shall use appropriate safety equipment and protective clothing. ORTA will provide same if the operator does not possess it.

(d) All work crews should include at least one person trained in first aid and this person should not be operating power equipment.

(e) In the case of chainsaws and brush cutters, appropriate safety equipment consists of a minimum of:

- hard hat with eye and ear protection
- CSA approved safety boots
- chainsaw pants or chaps
- chainsaw gloves

In the case of string trimmers, appropriate safety equipment consists of a minimum of:

- eye and ear protection
- high top safety boots
- Long pants made of heavy material
- heavy-duty, non-slip gloves

2.2 TRAINING

(a) Operators of chainsaws must have verifiable experience or have completed an approved chainsaw safety course.

(b) ORTA may arrange training courses depending upon need and availability.

(c) The Trail Director will maintain a list of approved chainsaw safety courses.

(d) ORTA will reimburse the cost of required training courses.

(e) Training courses are offered by some community colleges, equipment manufacturers and distributors, the Bruce Trail Association, the Ontario Forestry Safe Workplace Association, the Construction Safety Association of Ontario, Landscape Ontario Horticultural Trades Association, and others. Courses may also be offered by your local Ministry of Natural Resources or Conservation Authority office.

(f) A list of trained, qualified persons will be kept by ORTA.

2.3 OPERATING TIPS

- (a) During the use of a chainsaw, two people besides the operator should be present to ensure safety of the operator and any other persons in the vicinity. One person should be positioned on the trail to each side of the chainsaw operator to warn any approaching hikers.
- (b) The brush cutter operator must be given a wide berth; concentration on controlling the swath and the direction of the blade coupled with the noise of the machine will make the operator oblivious to other workers "in the way".
- (c) Operating a brush cutter can be tiring when used continuously for long periods. It is recommended that a second qualified person be present to take turns operating the machine.
- (d) One person should precede the cutter to remove rocks, branches, bottles, cans and other debris which could become a projectile or damage the equipment

APPENDIX D - SAMPLE SAFETY FACT SHEET

Sample Safety Fact Sheet

Tools for Trail Work¹⁴

A wide variety of tools are available to layout, construct, and maintain trails. Local and individual preferences often dictate the kinds of tools which are chosen for various tasks. Some of the most commonly used tools and tips on using the tool safely and effectively are presented. Every trail worker needs to learn how to choose the correct tool for the job, use it effectively and safely, care for it, and store it properly.

Tool Safety

The following should be covered with crewmembers before the start of any trail work.

Proper use begins with a good grip. Wet or muddy gloves may cause a tool to slip from your hands, striking you or someone near you.

Watch out for people around you. When chopping or brushing, be aware of any people in the surrounding area. The combined length of your arm and tool could reach a person working near you. Also, be aware of trail users. Often a user may try to pass right into your back swing. If you see someone coming, stop work, notify your co-workers and wait for them to pass.

Make sure you have a clear area in which to swing. Watch out for overhead or side hazards. A hazard is anything that could interfere with the complete swing of your tool, and knock it from your hands or down onto any part of your body. Keep your tool in front of you at all times. You should never need to swing your tool over your head.

Be alert for hazardous footing. Make sure you have a firm, balanced, and comfortable stance before starting your work. Clear limbs, sticks, loose rocks, or other debris from your footing area. Particularly with striking tools—make sure your feet are spaced well away from your target area.

Choose the right tool for the job. The wrong tool can make you work in an awkward stance which will wear you out.

Make sure your tool is sharp. A dull tool that bounces or glances off of what it was attempting to cut can be very dangerous. A sharp tool will cut faster and be less tiring.

Carry the tool properly. Always carry tools in your hands and down at your side on the down hill side of the trail. Use blade guards whenever possible. Never carry tools over your shoulder.

Travel safely. Stay at least 10 feet apart on the hike in and out from the work site—space yourself along the trail.

APPENDIX E - SAMPLE TRAIL RISK INSPECTION REPORT

Alberta Snowmobile Association

Snowmobile Club Trail Risk Checklist (sample)

The varying activities that can be part of any event, trail project or maintenance operation can provide a difficult risk management environment for a club to manage. Activities often involve other groups or individuals, can involve major risks, can involve a number of people coming together for a short period of time and the physical environment can be challenging. This checklist is intended to provide a starting point for you to use to develop your own specific risk management checklists. Every club has risks specific to them – only YOU can identify them. Look and understand the risk management process in the accompanying handbook. The primary goal is to prevent injury to ourselves and others. But also to measure the impact on all facets of club operations. The checklist is not complete and you should attempt to identify all areas of risk that may deal with finance, planning, volunteers, law, etc.,etc.

Potential Risks Identified	Date mm/dd/yr	Problems Detected (if any)	(a) Likelihood Scale of 1 to 10	(b) Impact Scale of 1 to 10	Risk rating % (equals sum of a+b x 5)	Who will fix the problem	Action Item	Date when will be fixed (mm/dd/yr)	Signed off
Trail Maintenance									
Have you applied for necessary permits from the appropriate authorities?									
Permission from landowners?									
Contact list for committee members responsible?									
Contact list for Volunteers?									
Sufficient manpower for the project?									
Have you selected a project manager?									
Are your staff and volunteers adequately qualified?									
Food & drink for Volunteers?									
Do you have a checklist to ensure you have all appropriate documentation, such as the work plan including emergency plan?									
Will there be road closures?									
Do you have a contact list for committee members responsible for each area of the project?									
Do you have Third Party liability insurance?									
Is property and equipment insured?									
Do you have any contractors?									
Does your contractor have third party liability insurance?									
Are you named as an additional insured on the contractor's policy?									

Alberta Snowmobile Association
Snowmobile Club Trail Risk Checklist (sample)

Potential Risks Identified	Date mm/dd/yr	Problems Detected (if any)	(a) Likelihood Scale of 1 to 10	(b) Impact Scale of 1 to 10	Risk rating %(equals sum of a+b x 5)	Who will fix the problem	Action Item	Date when will problem be fixed (mm/dd/yr)	Signed off
Trail Maintenance									
Do you have a contact list for all stakeholders?									
Have you prepared a site plan (map)? Do all stakeholders have a copy?									
Signage									
Do you have appropriate warning signs on-site? i.e. Groomer working.									
Do you have appropriate informational signs?									
Do you have adequate trail markers?									
Do you have directional signs?									
Trail Head signs?									
Do you have stop & yield signs at key intersections?									
Do you have signs showing location of emergency shelters?									
Do you have signs that lead to parking areas?									
Do you have mileage markers?									
Are main routes easily indentified?									
Do you have signs designed to the provincial standard?									
Do signs meet landowner / government requirements for size, visibility , etc?									

Alberta Snowmobile Association
Snowmobile Club Trail Risk Checklist (sample)

Potential Risks Identified	Date mm/dd/yr	Problems Detected (if any)	(a) Likelihood Scale of 1 to 10	(b) Impact Scale of 1 to 10	Risk rating %(equals sum of a+b x 5)	Who will fix the problem	Action Item	Date when will problem be fixed (mm/dd/yr)	Signed off
Trail Management									
Do you have fee collectors and or Snow Patrollers?									
Do you have a check-in procedure?									
Do fee collectors complete a daily report of passes sold & money collected?									
Do you have an emergency response plan? i.e. first aid									
Do you have an effective communication plan?									
Do you have a scheduling plan?									
Do Fee Collectors and Snow Patrol have Personal Safety Equipment. i.e. Hi Visibility Vest									
Do you have a plan for dealing with unruly visitors?									
Other?									
Other?									
Other?									
Cabins / Warm up shelters									
Are shelters in good repair?									
Is the roof in good repairs?									
Are handrails and stairs in good repair?									
Is out house available?									
Is outhouse in good repair?									
Are doors clear of snow?									
Are all stairs kept clear of snow and ice?									
Do you have frequent maintenance during the season?									
Are buildings insured for loss?									
Are all occupation permits/ leases etc up to date?									
Do you have yearly fees attached to shelters? ie taxes or lease fees?									

Alberta Snowmobile Association
Snowmobile Club Trail Risk Checklist (sample)

Potential Risks Identified	Date mm/dd/yr	Problems Detected (if any)	(a) Likelihood Scale of 1 to 10	(b) Impact Scale of 1 to 10	Risk rating %(equals sum of a+b x 5)	Who will fix the problem	Action Item	Date when will problem be fixed (mm/dd/yr)	Signed off
Cabins / Warm up shelters									
Are wood stoves safely installed?									
Do the stoves meet CSA or ULC standards?									
Are the chimneys installed in a safe manner?									
Do chimneys meet acceptable fire prevention standards?									
Are cabins / shelters cleaned regularly?									
Is firewood available in sufficient supply?									
Are cabins / shelters easily accessible to the public?									
Are cabins / shelters accessible by vehicle in the off season?									
Are canis / shelters used year round?									
Who maintains them in the off season?									
Other									
Other									
Other									
Other									
Groomers / drags									
Are groomers capable of the job required of them?									
Are groomers in good repair?									
Do you have a plan for regular maintenance of the machines?									
Do you have a plan for breakdowns on the trail?									
Who carries out major repairs?									
Do you have a funding formula to ensure sufficient operating funds?									
Do you have a single person designated as the Groomer leader?									
Are operators trained properly?									
Do you have minimum standards of experience for operators?									
Do you have safety equipment on the machines?									

Alberta Snowmobile Association
Snowmobile Club Trail Risk Checklist (sample)

Potential Risks Identified	Date mm/dd/yr	Problems Detected (if any)	(a) Likelihood Scale of 1 to 10	(b) Impact Scale of 1 to 10	Risk rating %(equals sum of a+b x 5)	Who will fix the problem	Action Item	Date when will problem be fixed (mm/dd/yr)	Signed off
Grommers									
Do you have a communication strategy for operators in the field?									
Is grooming scheduled?									
Is fuel stored in a safe location?									
Do you have a spill kit on each unit?									
Do you have a plan to combat potential spills?									
Are operators trained in the safe handling of fuel & oil in order to avoid spills?									
Is there a ERP for the groomer operators?									
Other									
Other									
Other									
Other									
Other									

Alberta Snowmobile Association
Snowmobile Club Trail Risk Checklist (sample)

Risk Chart							
LIKELIHOOD							
IMPACT	RATING		A (10-9)	B (8-7)	C (6-5)	D (4-3)	E (2-1)
			Frequent	Probable	Occasional	Remote	Improbable
	A (10-9)	Catastrophic	High	High	High	High	High
	B (8-7)	Critical	High	HIGH	High	Medium	Low
	C (6-5)	Important	High	High	Medium	Low	Low
	D (4-3)	Marginal	High	Medium	Medium	Low	Low
E (2-1)	Negligible	Medium	Low	Low	Low	Low	

Examples of risk measure:

MEASURE	IMPACT	Effect / Description
A	Catastrophic	Death
B	Critical	(Severe injury (e.g. loss or crushed limb, brain damage)
C	Important	Major Injuries – require medical assistance (inc concussions)
D	Marginal	Minor Injuries, cuts, treated internally (inc minor sprains
E	Negligible	No Injuries

Measure	Likelihood	Description
A	Frequent	Will occur regularly – day to day
B	Probable	Will occur on most occasions, circumstances
C	Occasional	Will occur from time to time
D	Remote	May occur but not regularly or often
E	Improbable	Unlikely to ever occur

Risk Priority calculations:

Each club that starts to identify the risks involved with a project will soon become over whelmed if a process for measuring priority is not applied to the results. Resources such as volunteer time and money should assigned to the most important or highest risk items in order for there to be effective implementation of your risk management plan. *(continued)*

Alberta Snowmobile Association
Snowmobile Club Trail Risk Checklist (sample)

(Continued from page 6)

Depending on the number of "Risk Potentials" identified for a specific project, it may be necessary to assign priority to each item. This is easily done if there are only 5 or 6 " Risk Potentials" to be dealt with on a checklist. But as the complexity of a project increases so do the number of " Risk Potentials" that are indentified. And as the number increases it becomes more difficult to choose which items should be addressed first.

In Order to simplify the process of prioritizing the "Risk Potentials" the Checklist has two columns that are used to assign (1) Likelihood and (2) level of Impact. Under each of these heading you are asked to rate the particular Risk Potential on a scale of 1 -10 (1 being least and 10 being highest). There is then a third column that asks for" Risk rating % " and that is the "priority" of a risk calculated by adding the "Likelihood" value to the "Impact" value and multiplying by "5". The result as illustrated below is a figure between 1 & 100 with 100 being the most important. As each item on the list is assigned a priority percentage it is slotted into the priority list.

Potential Risks Identified	Date mm/dd/yr	Problems Detected (if any)	(a) Likelihood Scale of 1 to 10	(b) Impact Scale of 1 to 10	Risk rating %(equals sum of a+b x 5)	Who will fix the problem	Action Item	Date when will problem be fixed (mm/dd/yr)	Signed off
Cabins / Warm up shelters									
Are wood stoves safely installed?	1987	Chimney appears weak and has poor attachment points.	9	8	9+8*5= 85				

Acknowledgements:

This checklist, and the back ground information included in the documents that accompany it, are written for the sole purposes of information for snowmobile clubs to make the first steps towards effective risk management. The author has used a variety of sources to develop the information and specifically wishes to acknowledge the assistance of an online risk management program presented by "our community.com" . Freely available at www.ourcommunity.com.au. The information used from their website is presented in substantially the same form as is available on line.

I would suggest that for more Checklist ideas and for a more detailed examination of the risk management process this site is well organized and very informative.

Other sites that can be of some use in formulating a risk management plan are:

<http://www.managementhelp.org/legal/rskmgmnt.htm>

https://www.riskinstitute.org/peri/index.php?option=com_bookmarks&task=detail&id=562

DISCLAIMER:

While all care has been taken in the preparation of this material, no responsibility is accepted by the author(s) or ASA, its staff or volunteers, for any errors, omissions or inaccuracies. The material provided in this help sheet has been prepared to provide general information only. It is not intended to be relied upon or be a substitute for legal or other professional advice.

No responsibility can be accepted by the author(s) or the ASA for any known or unknown consequences that may result from reliance on any information provided in this handbook.

Appendix A

TRAIL CONDITION REPORT

CHAPTER :

NOTE: The ORT Guide For Trail Maintenance and risk management requires that this report be filled out in the spring and fall of each year.

Describe Section Inspected (e.g. between where and where):															
Guidebook Map Number:															
Inspection Date:															
Spring:	Fall:	Year:													
<p>CHECK (✓) ITEMS IF IN SATISFACTORY CONDITION. IF NOT, PUT X AND COMMENT INCLUDING ACTION TAKEN OR TO BE TAKEN. REPORT MAJOR PROBLEMS AT ONCE TO YOUR CHAPTER CHAIR IMMEDIATELY.</p> <p><input type="checkbox"/> Litter collected and disposed of (including parking areas).</p> <p><input type="checkbox"/> Grass and shrubbery trimmed.</p> <p><input type="checkbox"/> Branches pruned back, stumps removed, windfalls cleared.</p> <p><input type="checkbox"/> Safety hazards eliminated (dead limbs, leaning trees, loose rocks etc.)</p> <p><input type="checkbox"/> Stiles safe and firmly in place.</p> <p><input type="checkbox"/> Fences in good condition</p> <p><input type="checkbox"/> Slope erosion under control.</p> <p><input type="checkbox"/> Do wet areas have dry crossings.</p> <p><input type="checkbox"/> Bridges in good repair with decking intact.</p> <p><input type="checkbox"/> Blazes in good condition and according to ORTA policy.</p> <p><input type="checkbox"/> Visibility adequate and not confusing</p> <p><input type="checkbox"/> Old unnecessary blazes - scraped off or painted over</p> <p><input type="checkbox"/> Proper signage on trail and in good repair.</p> <p><input type="checkbox"/> Need for additional signs:</p> <p><input type="checkbox"/> Small ORT A signs Number needed:</p> <p><input type="checkbox"/> 12X12 ORTA signs Number needed:</p> <p><input type="checkbox"/> <input type="checkbox"/> Other signs needed Describe and attach drawing, dimensions)</p> <p>CIRCLE YES OR NO.</p> <table style="width: 100%; border: none;"> <tr> <td style="width: 60%;">Any signs of vandalism or misuse of trail?</td> <td style="width: 10%;">Yes</td> <td style="width: 10%;">No</td> <td style="width: 20%;"></td> </tr> <tr> <td>Any problems with fires in unauthorized places?</td> <td>Yes</td> <td>No</td> <td></td> </tr> <tr> <td>Any parking problems, e.g. laneways obstructed?</td> <td>Yes</td> <td>No</td> <td></td> </tr> </table>				Any signs of vandalism or misuse of trail?	Yes	No		Any problems with fires in unauthorized places?	Yes	No		Any parking problems, e.g. laneways obstructed?	Yes	No	
Any signs of vandalism or misuse of trail?	Yes	No													
Any problems with fires in unauthorized places?	Yes	No													
Any parking problems, e.g. laneways obstructed?	Yes	No													
<p>TRAIL CAPTAINS PLEASE NOTE:</p> <ul style="list-style-type: none"> • Advise Chapter Chair or Trail Director immediately of any land for sale on or near the ORT trail. • Use the back of this sheet for any further comments, including suggestions for improvements of any kind. • Report on or within a week of the date specified, and send the completed form promptly to your Chapter Chair, who will arrange any assistance needed and report conditions to the Trail Director. 															
Trail inspected by (Please print):															
Trail Captain:	Tel:	email or Fax:	Signature:												
Chapter Chair:	Tel:	email or Fax:	Signature:												

Trail Assessment Form

Trail Assessment Form

Observer:

Date:

Trail segment: From _____ to _____.

Landowner:

Contacted first **Y** **N** (circle one)

General condition of trail (or route):

	Poor	Average	Good	Excellent
Drainage				
Tread condition				
Furniture/ stiles/ gates				
Bridges				
Erosion				
Litter				
Landowner response				

- | | Work required | Location | Tools or materials |
|----|---------------|----------|--------------------|
| 1. | | | |
| 2. | | | |
| 3. | | | |

General comments regarding your visit:

APPENDIX F - SAMPLE TRAIL INCIDENT REPORT

ALBERTA SNOWMOBILE ASSOCIATION

INCIDENT REPORT (GENERAL) PART ONE

1. All claims should be reported by telephone to 1.888-818-5821 as soon as possible. This step is crucial to the identification of emergency situations in which quick action by qualified authorised personnel can act to reduce or even eliminate losses.
2. A completed Incident Report form must then be forwarded to the adjuster for every potential claim. Fax to 1.250.860.1213 attention Claims Department.
3. Make sure a blank copy of this form is available in the organisation's office and at any events and always keep a copy of the completed Incident Report form for your records.

(SECTION A) GENERAL INFORMATION
--

Name of Insured/Location		Date of Loss/Injury/Incident	
Address	Town/City	Province	Postal Code
Address where loss/injury occurred	Town/City	Province	Postal Code
Name of person filing report (please print)	Position (if applicable)	Daytime Phone No. ()	
Alternate Contact Person's Name	Position (if applicable)	Daytime Phone No. ()	

SECTION (B) PROPERTY INCIDENT REPORT PARTICULARS

Policy number	Certificate number
<input type="checkbox"/> Building <input type="checkbox"/> Contents <input type="checkbox"/> Boiler & Machinery <input type="checkbox"/> Crime <input type="checkbox"/> Other (Specify)	

What happened? Provide a brief synopsis of the incident, describing damage and including date and time, circumstances and estimate.

Date	Signature
------	-----------

POLICE OR FIRE (IF APPLICABLE)

Fire Chief's/Police Officer's Name	<input type="checkbox"/> Police <input type="checkbox"/> Fire	Division/Badge No.	Phone No. ()
------------------------------------	--	--------------------	------------------

WHAT YOU CAN DO TO ASSIST

1. Protect your property from further damage. For example:
 - a) Install temporary covering to the building if exposed to the elements
 - b) Move equipment to an unaffected area of the premises
2. Do not throw anything out unless it is absolutely necessary. Make certain these relevant items are kept for examination.
3. If possible, obtain photographs of the site of the accident, fire, or other loss.
4. In the event of theft or dishonesty, call the police at once.

continued



ALBERTA SNOWMOBILE ASSOCIATION

COMPREHENSIVE GENERAL LIABILITY INCIDENT REPORT (PART TWO)

(SECTION C) PARTICULARS

This incident involves: Bodily Injury/Personal Injury Damage to Third Party's Property by Insured
 Is there more than one claimant: Yes No **If yes, complete and incident report for each claimant!**
 Was there alleged to be a hazardous condition causing the incident? Yes No **If yes describe:**

What was the claimant doing immediately before the accident occurred?

Did the claimant's actions cause or contribute to the incident? Yes No **If yes, how?**

Was another person alleged to have caused the incident? Yes No **If yes, who:**

Name	Address	Daytime Phone No. ()
------	---------	--------------------------

INCIDENT DETAILS

Description of Incident (Also describe the location within premises or beyond premises where it happened)

COMPLETE THIS SECTION IF PERSON(S) INJURED

Name of Person Injured	Age (approximately)	<input type="checkbox"/> Male <input type="checkbox"/> Female	Guardian If Minor
Address	Town/City	Daytime Phone No. ()	
Occupation	Employed by	Daytime Phone No. ()	
Nature and Extent of Injury	Was medical treatment required? <input type="checkbox"/> Yes <input type="checkbox"/> No	Treatment <input type="checkbox"/> by Doctor <input type="checkbox"/> at Hospital <input type="checkbox"/> None Required	

WITNESSES (VERY IMPORTANT)

Name	Address	Daytime Phone No. ()
Name	Address	Daytime Phone No. ()

Additional Remarks _____

PLEASE ALSO COMPLETE SECTION A / SIGNATURE OF PERSON COMPILING REPORT
--

Date	Signature
------	-----------

WHAT YOU CAN DO TO ASSIST

1. Do not admit liability. Legal liability is a complex matter.
2. Make sure that any injured person receives immediate first aid. Call an ambulance if necessary.
3. It is vital that any letter from a claimant or lawyer, or court forms be sent immediately to the assigned adjuster handling the loss.



APPENDIX G - SAMPLE TRAIL USE & INDEMNIFICATION AGREEMENT



LICENCE AGREEMENT

THIS LICENCE AGREEMENT MADE as of the _____ day of _____, 200__.

BETWEEN:

(the "Owner")

OF THE FIRST PART

- and -

(the "Occupier")

OF THE SECOND PART

- and -

(the "Club")

OF THE THIRD PART

WHEREAS the Owner is the registered owner and the Occupier is the authorized occupier of the lands legally described as:

Meridian: _____
Range: _____
Township: _____
Section: _____
Quarter: _____
in the county of: _____

(the "Lands").

AND WHEREAS the Club is a duly authorized snowmobiling club affiliated with the Alberta Snowmobile Association;

AND WHEREAS the Club has requested the right to use the Lands of the Owner / Occupier for the purposes of allowing Individual Trail Pass Members of the Club to use the trails on the Lands for snowmobiling. In consideration of the covenants herein contained, the parties covenant and agree with each other as follows:

1. An Individual Trail Pass Member shall mean a member in good standing of the Club, of the Alberta Snowmobile Association or of any other snowmobiling club affiliated with the Alberta Snowmobile Association, authorized to use the Trails for the purposes of snowmobiling. A snowmobile operator who is not an Individual Trail Pass Member of the Club or an Individual Trail Pass Member who fails to present upon request to the Owner / Occupier proof of current membership, will be denied access to the Trails.

2. The Owner / Occupier grants to the Club a licence to enter, establish, groom, maintain, sign and use that portion of the Lands as designated on the attached Schedule "A" (the "Trails") for the exclusive purpose of allowing Individual Trail Pass Members of the Club to use the Trails for snowmobiling.

3. The Owner / Occupier shall grant access to the Lands prior to and after the winter months for the purpose of opening and closing, upgrading and maintaining the Trails when there is no snow cover, provided the Club receives prior verbal consent before accessing the Lands.

4. The Club will:

- (a) repair or replace property damaged by Individual Trail Pass Members on the Trails used for snowmobiling;
- (b) maintain the Trails to be used by Individual Trail Pass Members in reasonably good condition for snowmobiling excluding any damage caused to crops;
- (c) undertake to post appropriate signage; and
- (d) remove on an annual basis any litter caused by any Individual Trail Pass Members;

5. The Club shall maintain general third party liability insurance with a limit of at least \$1,000,000.00, which provides for insurance coverage to the owners and occupiers of the Lands, to cover land uses specified herein. The insurance company shall defend all actions commenced under the coverage of this policy, up to the policy limits, on behalf of the Owner / Occupier. This coverage is confirmed to the Owner / Occupier by signing this licence agreement on the condition that no fee has been charged by the Owner / Occupier for the use of the Trails.

6. The Club hereby indemnifies the Owner / Occupier against all liability and claims for compensatory damages for bodily injury and property damage in connection with the operation of the trails.

7. This Licence may be terminated by either party, without cause, by giving 60 day prior written notice to the other party at the address designated below.

8. If any term of this Licence is determined to be invalid or unenforceable by any court, such determination will not invalidate the rest of this Licence which will remain in full force and effect as if the invalid term had not been made part of this Licence.

9. The Owner / Occupier and the Club acknowledge that they do not rely upon any information or statement, oral or written, express or implied, given to each other.

10. This Licence constitutes the entire agreement between the Owner / Occupier and the Club and any and all previous agreements, written or oral, express or implied, between the parties or on their behalf relating to the use of the Lands are hereby terminated and cancelled. Any modification to this Licence must be in writing and signed by the parties or it will have no effect and will be void.

11. In this Licence, words importing the singular number will include the plural and vice versa, and words importing persons will include individuals and clubs and vice versa.

12. Each party will at the request and expense of any other party sign and deliver such further or additional documents as may reasonably be considered necessary or desirable by the respective parties to properly reflect and carry out the true intention and meaning of this Licence.

13. This Licence will be construed and enforced in accordance with, and the rights of the parties will be governed by, the laws of the Province of Alberta.

14. The Club is hereby authorized to act as the Owner / Occupier's agent to supervise and enforce the uses identified herein with respect to the Trails in accordance with the *Petty Trespass Act*, R.S.A., 1980, c.P-6, *Occupier's Liability Act*, R.S.A. 1980, c.O-3, and *Off-Highway Vehicle Act*, R.S.A. 1980, c.O-4, as amended from time to time.

Signature of Owner

Club: _____

Name of Owner
Address:

Signature of Club President
Address:

Signature of Occupier

Name of Occupier
Address:

APPENDIX H - AVALANCHE SAFETY PLANS

Recommended Generic Table of Contents

Avalanche Safety Plans

The intent of this recommended generic table of contents is to facilitate the development of avalanche safety plans required under the recently approved WSBC regulation, and to encourage reasonable congruency within and between sectors. It is hoped that organizations such as Canada West Ski Areas Association, HeliCat Canada, Backcountry Lodges of BC, BC Commercial Snowmobile Operators Association and others will use this generic content to develop sector specific templates for their members to use when producing avalanche safety plans for their individual operations.

Geographical description (overview of location and climate) **Operational goals, objectives, priorities** **Supervision and reporting**

- Organization chart
- Role - responsibility statements for all reporting levels through to employer

Staffing

- Numbers, qualifications and/or certifications for each

Training

- Initial and recurrent training courses (essential, desirable)
- On-the-job training objectives

Equipment, infrastructure requirements

- Snow & weather Communications Avalanche control Explosives storage, transportation and use Signs, fences, barriers, etc.
- Vehicles, office & storage, information and data management
- Personal protective equipment

Operational procedures

- Pre-season tasks checklists Data collection (sources & mechanisms) Daily agenda Hazard - risk evaluation Risk mitigations (avalanche control methods, as appropriate for the operation) Communications
- Event reporting, check-in procedures Information sharing (InfoEx, etc)
- Public information Documentation
- Post-season tasks checklists
- Others, as appropriate

Emergency response procedures **Accident - incident investigation, reporting** **Safety inspections, audits (quality assurance)**

Appendices

- Avalanche Atlas Terrain zoning
- Risk assessment(s) as per WSBC requirements Explosives storage, transportation and use - WSBC, NRCan approved procedures Staff training records Equipment, materials inventories Compendium of all relevant legal, regulatory, contractual, other references

CAA Recommended Minimum Training and Experience for Qualified Avalanche Planners

Role: Planner (Consultant) for active avalanche safety programs. See companion DRAFT Scope of Practice document

Credentials, Training & Experience

Criteria listed below in bold font are core criteria to be met by the “planner of record”. Criteria in regular font may be provided by supporting members on the planning team.

“Qualified Avalanche Planner” as defined in Part 4.1.2 (1) of proposed WSBC regulation

CAA Ops L2 course graduate, c/w Module 1

Annual filing, CAA CPD program compliance

Seasons experience, avalanche operations

Seasons experience, avalanche program management / quality assurance, this sector

Professional liability insurance coverage

Introductory avalanche mapping course

Meteorology or avalanche weather course

Avalanche forecasting course***

Advanced avalanche rescue course**

Guide certification (as per sector standard)

Advanced avalanche mapping course

Avalanche blasting course

Avalanche blasting ticket (valid)

Safety in winter operations course***

Avalanche accident investigation experience

Relevant post-secondary degree

University level statistics course

Sector Specific Recommended Minimum Qualifications

	Downhill Ski Resorts	Mechanized Wilderness Guiding	Non- mechanized Wilderness Guiding	Highways, Railways, Buildings, Forestry & Construction Ops	Govt. & NGO “Public Service” Programs	Snowmobile Wilderness Guiding
“Qualified Avalanche Planner” as defined in Part 4.1.2 (1) of proposed WSBC regulation	Yes	Yes	Yes	Yes	Yes	Yes
CAA Ops L2 course graduate, c/w Module 1	Yes	Yes	Yes	Yes	Yes	Yes
Annual filing, CAA CPD program compliance	Yes	Yes	Yes	Yes	Yes	Yes
Seasons experience, avalanche operations	15	15	15	15	15	15
Seasons experience, avalanche program management / quality assurance, this sector	3	3	3	3	3	3*
Professional liability insurance coverage	Yes	Yes	Yes	Yes	Yes	Yes
Introductory avalanche mapping course	Yes	Yes	Yes	Yes	Yes	Yes
Meteorology or avalanche weather course	Yes	Yes	Yes	Yes	Yes	Yes
Avalanche forecasting course***	Yes	Yes	Yes	Yes	Yes	Yes
Advanced avalanche rescue course**	Yes	Yes	Yes	Yes	Yes	Yes
Guide certification (as per sector standard)		Yes	Yes		Desirable	Yes**
Advanced avalanche mapping course	Desirable			Desirable		
Avalanche blasting course	Yes	Yes		Yes		Desirable
Avalanche blasting ticket (valid)	Desirable	Desirable		Desirable		Desirable
Safety in winter operations course***	Desirable	Desirable	Desirable	Desirable	Desirable	Desirable
Avalanche accident investigation experience	Yes	Yes	Yes	Yes	Yes	Yes
Relevant post-secondary degree					Desirable	
University level statistics course	Desirable	Desirable	Desirable	Desirable	Desirable	Desirable

* For BC Commercial Snowmobile Operators Association (BCCSOA) members this sector experience requirement may be filled by a supporting member of the planning team due to limited capacity within existing operators. ** BCCSOA guide standards and certification process to be implemented by 2010.

*** These training programs are currently under development by the CAA, and will be available by fall, 2008.

NOTE 1: For all categories of workers described in this document, specified formal training requirements may be met through an “or equivalent” training determination under the Prior Learning Assessment Review (PLAR) process conducted by the CAA Education Committee.

CAA Recommended Minimum Training and Experience for Qualified Avalanche Planners

Role: Planner (Employee) for active avalanche safety programs. See companion DRAFT Scope of Practice document

Credentials, Training & Experience	Sector Specific Recommended Minimum Qualifications					
	Downhill Ski Resorts	Mechanized Wilderness Guiding	Non-mechanized Wilderness Guiding	Highways, Railways, Buildings, Forestry & Construction Ops	Govt. & NGO "Public Service" Programs	Snowmobile Wilderness Guiding
Criteria listed below in bold font are core criteria to be met by the "planner of record". Criteria in regular font may be provided by supporting members on the planning team.						
"Qualified Avalanche Planner" as defined in Part 4.1.2 (1) of proposed WSBC regulation	Yes	Yes	Yes	Yes	Yes	Yes
CAA Ops L2 course graduate, c/w Module 1	Yes	Yes	Yes	Yes	Yes	Yes
Annual filing, CAA CPD program compliance	Yes	Yes	Yes	Yes	Yes	Yes
Seasons experience, avalanche operations	10	10	10	10	10	8*
Seasons experience, avalanche program management / quality assurance, this sector	5	5	5	5	5	3*
Introductory avalanche mapping course	Yes	Yes	Yes	Yes	Yes	Yes
Meteorology or avalanche weather course	Yes	Yes	Yes	Yes	Yes	Yes
Avalanche forecasting course***	Yes	Yes	Yes	Yes	Yes	Yes
Advanced avalanche rescue course***	Yes	Yes	Yes	Yes	Yes	Yes
Guide certification (as per sector standard)		Yes	Yes		Desirable	Yes**
Advanced avalanche mapping course	Desirable			Desirable		
Avalanche blasting course	Yes	Yes		Yes		Desirable
Avalanche blasting ticket (valid)	Desirable	Desirable		Desirable		Desirable
Safety in winter operations course**	Desirable	Desirable	Desirable	Desirable	Desirable	Desirable
Avalanche accident investigation experience	Yes	Yes	Yes	Yes	Yes	Yes
Relevant post-secondary degree					Desirable	
University level statistics course	Desirable	Desirable	Desirable	Desirable	Desirable	Desirable

* For BC Commercial Snowmobile Operators Association (BCCSOA) members this sector experience requirement may be filled by a supporting member of the planning team due to limited capacity within existing operators. ** BCCSOA guide standards and certification process to be implemented by 2010.

*** These training programs are currently under development by the CAA, and will be available by fall, 2008.

NOTE 2: Plans prepared by a planner (employee) should be peer reviewed by a commensurately qualified individual from another organization in the same sector prior to being accepted and implemented by the employer.

APPENDIX I - EXTREME TRAILS WAIVER POLICY AND FORMS

***Alpine Club of Canada's Policy Regarding
Waiver Administration, Incident Management & Reporting***

**TO: All Alpine Club of Canada Trip Leaders and Section Executives
FROM: National Office**

Policy as it applies to Trip Leaders

These instructions are to be given to all trip leaders along with blank waivers for all activities. This policy and all related documents are on the Alpine Club of Canada's website

A. Waiver Administration

As trip leaders, you are required to have participants in all activities sponsored by The Alpine Club of Canada (ACC) sign the official Release, Waiver and Assumption of Risk (hereinafter referred to as the Release) before the activity begins. The importance of this document to The Alpine Club of Canada cannot be over-emphasized. The way you conduct yourself in dealing with participants signing the Release is of great importance to whether the document "will stand up in court" later on. As a result, the following steps should be followed when having participants execute the Release:

How to get waivers signed properly

Instructions you may need to give to Participants:

- Read and understand the Release before signing and dating it. This Release is easy to read and is in plain English. If you do not sign and submit the Release, you will not be able to participate in your chosen activity.
- The Release is available in English & French.
- If you have any questions about the meaning of the Release, ask for assistance from the national office of The Alpine Club of Canada and they will be able to explain the document in detail.
- You cannot change any terms of the Release prior to signing it.
- The witness to your signature must be a non-family member. It is preferred that the witness is an Alpine Club of Canada member, volunteer or employee. Each witness should confirm that you have read and understood the Release.
- Do not rush through reading the Release - leave yourself ample opportunity to read and understand its terms in advance of your chosen activity.
- If you refuse to sign the Release, you will not be able to participate in the chosen activity.

Instructions for Trip Leaders:

1. You must ensure that the participant has had time to read the Release before signing and dating it. Make sure they are not rushed during this important part. If you are able, it is often advisable to have participants read and sign the waiver well in advance of the activity e.g. days or weeks before the activity. The waiver is available for viewing on the Alpine Club of Canada's website and trip leaders should encourage participants to read this and understand its contents prior to any trip. Be sure that participants are aware that if they do not sign the Release they will not be able to participate in the Activity.

2. You must ask each participant whether they have any questions about the meaning of the Release and, if they do have any questions, you should do your best to answer them. If you can't, questions should be referred to the Executive Director of The Alpine Club of Canada who will be able to explain the document in detail.

3. Nothing in this Release can be changed in any way and it must be signed “as is” as a condition of participating in the proposed activity.
4. You must understand the Release yourself. Read it very carefully and make sure that you understand its terms. If you do not understand any of its terms, or don't feel that you are capable of explaining it to someone else, please contact the Executive Director of The Alpine Club of Canada, who will provide you with an explanation to address your concerns.
5. Should participants ask you to tell them what the document says, be sure to emphasize that they are required to read it and understand it before signing, and before they will be able to participate in the activity. You can tell them that it is a document which protects The Alpine Club of Canada from lawsuits in the event that a participant is injured or killed or has any of his property or personal belongings damaged or lost. The Release also protects The Alpine Club of Canada from liability for not only natural hazards but for the negligence of any of the other ACC member participants. You should also tell them that the document includes a clause where each participant agrees that, should evacuation or rescue become necessary, each participant agrees to pay the cost of that evacuation or rescue.
6. The witness to the participants' signature must be a non-family member. You can witness the person's signature or one of the other participants can witness the signature. The preferred approach, if possible, is to have the participant's signature witnessed by an Alpine Club of Canada member, volunteer or employee. Each witness should ask the participant if he/she has read and understood the release, which is critical to its legal validity. Minors must have their parent/guardian sign the Release and trip leaders must be satisfied that the minor is able to and does participate in the activity safely.
7. If an individual refuses to sign the Release, you must advise them that he or she will not be able to participate in the activity.
8. The Release is available in the following languages: English and French. The person should be provided with a Release that is written in the language that he or she is most comfortable with.
9. For "repeat" and virtually “ identical” activities (e.g. weekly or monthly sessions at the same climbing wall), participants need only sign the Release once per year. For all other activities, including all outdoor activities, a separate Release must be signed prior to each activity.

What to do with the Release(s) after signing

11. Assuming that an incident does not occur during a given activity, signed Releases must be retained by the Section for a period of six years, after which time they can be destroyed. Please return all signed Releases as soon as possible following an activity to the person in your Section who has been given the duty of looking after these documents.

B. Incident Management

If an incident results in injury, property damage or loss (or if the trip leader feels that an injury or property damage/loss situation could possibly be claimed at some later time), the following process should be followed:

Administer appropriate incident management procedures

Trip leaders will have the responsibility of carrying out or delegating whatever actions are necessary to manage the situation until the victim has been turned over to the appropriate rescue, health care or other authorities. Your incident report will deal with the events up to that point.

Complete an incident report

The trip leader or other designated individual must contact the Executive Director at the Alpine Club of Canada's National Office as soon as possible regarding the incident. One scenario would be for the trip leader to contact the Section Chair and that person would contact the Executive Director. This must be done **as soon as possible after the incident occurs**.

In addition, a complete, written incident report must be prepared **as soon as possible after the incident occurs**, sent to the Section Executive who will send it on via the Section Chair to the Executive Director. The original, signed Releases(s) of all persons who suffered (or might later claimed to have suffered) personal injury or property damage/loss as a result of the incident must accompany this report. In this report, it is important to record all relevant information about the incident: times, location, activity being undertaken at the time of the incident, etc. Opinions or speculations as to how the incident could have been avoided should not be included. It is the Section Executive's duty to ensure that the report is complete before submitting it to the Executive Director.

Under normal circumstances, it is expected that an incident report will be in the Executive Director's hands no later than a maximum of 3 weeks after the incident.

Do NOT talk to the media about the incident. Any questions from the media are to be referred to the Executive Director of the Alpine Club of Canada. No copies of any Releases or incident reports are to be provided to the victim or any other person.

Policy as it applies to Section Executives

Waivers & Trip Leaders

For a number of years, the Alpine Club of Canada (ACC) has required participants in ACC activities to read and sign waivers prior to taking part in official activities. Because of issues relating to the ACC's insurance, this requirement was extended to ACC Section activities some years ago. Although never passed by the Board, the practices outlined in this document have actually been in place for several years now. These informal practices now have the importance of ACC Policy and all ACC Sections are obligated to ensure their activities meet the requirements outlined.

Sections must be aware of and make certain that its trip leaders are aware of the necessity of having signed waivers for ALL Section activities before the activity takes place. The ACC's liability insurance depends on this policy being carried out properly without exception.

Each Section should make sure it has a process that will acquaint its trip leaders with the contents of the waivers, the reasons for having them completed properly, how to complete the waivers properly, the procedure to be followed should there be an incident on a Section activity, where waivers are to go after an activity, how soon completed waivers are to be returned following an activity and how to complete an incident report, should that ever be necessary.

The first part of this policy is to be given to all trip leaders along with blank waiver forms to be used for every Section activity. This policy and all related documents are on the ACC's website. Sections are encouraged to find ways to acquaint their members new and old with the waiver requirement for all Section activities in advance of those activities. This could involve having new members sign a waiver when they join, having members sign a waiver once a year at an annual meeting or other function, including a copy of the waiver in the Section newsletter once a year, etc. Whatever method is used, the objective is to emphasize and demonstrate the concept of "informed consent" and the understanding that participants release the ACC from any liability in the event of injury or loss.

There is no legal requirement for trip participants to be ACC members, but non-members are not covered by the ACC's insurance should they be found negligent in causing someone personal injury or property damage/loss. It is strongly recommended that all trip participants become members of the ACC, as this protection is one of the benefits of membership.

Each Section must develop a process for gathering and keeping all waiver forms from all Section trips and activities. Such documents are obviously needed should there be an incident resulting in any injury or loss, but it may be necessary to provide signed waivers from earlier activities that a participant has been on should a later incident occur that involves that participant. Such documentation can help to show that there was informed consent on some number of previous occasions. For this reason, completed waivers should be kept on file for at least 6 years.

Incident Reporting

Once an incident resulting in injury or loss has taken place and the trip leader has filed an incident report and handed over the signed waiver forms, the Section Executive will handle the rest of the tasks as follows:

The incident report, together with a copy of the signed Releases of all persons involved in the event (victims and anyone who might be alleged to have caused the incident), must be forwarded to the Executive Director at National Office, as soon as reasonably possible. No one else, including the victim(s), should be given a copy of the incident report or Release(s).

The trip guide (national trips) or section chair (section trips) is required to file the incident report with National Office as soon as possible after it occurs. Note that for Section trips this policy requires the report to come to National Office from the Section chair, and not directly from the trip leader – the purpose is to make sure the "most senior" volunteer in the section is aware of and approves the report before he/she

sends it to National Office. While there are no guidelines as to what should/should not be in the report, the rule of thumb is that it should be a complete and accurate description (with times, locations, etc.) of the incident from the time it occurred to the time the victim is removed from the site and is in the care of “the authorities”. Also, for legal/liability reasons, the report must be factual only – no value judgements or speculations are to be included as to why it happened, how it could have been avoided, etc. The report should also contain a copy of the ACC Incident Report form, if appropriate (available on the ACC website), and must be accompanied by the original the waiver form signed by the victim prior to the activity.

Subsequently, a search should be conducted through all retained Releases to identify and extract any previous Releases signed by those involved in the reported incident. Copies of the previous Releases are to be forwarded to the Executive Director of the ACC as soon as possible.

For legal reasons, all originals and copies of Releases and previous Releases related to any incident, together with the incident report, must not be destroyed without the permission of the ACC’s Legal Committee.

How National Office will handle the report

If there is a reported incident on an “official” ACC activity (National or Section), the Executive Director of the ACC will notify the insurance company of this and tell them a report will be filed with them as soon as possible. Under normal circumstances, it is expected that incident reports will be submitted to the insurance company no later than a maximum of 4 weeks after the incident.

When the report is received by the Executive Director, it is sent to the chairs of the Safety Committee and the Legal Committee so they can check it for accuracy and completeness, and ensure there are no statements that are value judgements, speculations, etc. If one or both of those people are not satisfied with the report, they inform National Office and their comment(s) will be passed on to the author of the report asking for the necessary revisions. As soon as both committee chairs are satisfied with the report, it is sent to our insurance company, to the Executive Committee and to the person responsible for Accidents in North American Mountaineering (ANAM).

The insurance company’s normal practice is to conduct an immediate investigation, in order to have a report on their file if and when a liability action is ever brought forward on the matter. Those investigations have become more detailed over the past few years. For example, they usually involve the insurance company interviewing the trip leader, the person(s) who administered and witnessed the waiver and one or more trip participants (particularly those who may have witnessed the incident).

The “maximum 4 weeks” timing for the incident report to be sent by the Executive Director to the insurance company is critical. For 2 main reasons:

- 1. the insurance company is interested in conducting its investigation and preparing its report while memories about the incident are still fresh in people’s minds. This is also in the Club’s best interests; and**
- 2. the Club’s on-going access to affordable liability insurance is dependant on many factors, including the Club demonstrating to the insurance company that it manages its affairs in a professional manner. The timely submission of complete and accurate incident reports contributes to that image of professionalism. Inaccurate, incomplete or untimely reports do not.**

If there is some possibility a complete and accurate incident report cannot be in the Executive Director’s hands within 4 weeks of the incident, the Section Chair should notify the Executive Director immediately.

**RELEASE OF LIABILITY, WAIVER OF
ALL POSSIBLE CLAIMS AND ASSUMPTION OF RISK**

(Ce formulaire est aussi disponible en français)



**Warning: By Signing This You Are Waiving Your Legal Rights
and You Give Up the Right to Sue**

PLEASE READ CAREFULLY

**To: THE ALPINE CLUB OF CANADA and HER MAJESTY THE QUEEN IN RIGHT OF CANADA
AS REPRESENTED BY PARKS CANADA**

PARTICIPANT(S) NAME(S): All Persons Signing This Form as Participants

ACTIVITY: All activities sponsored by or organized by or through The Alpine Club of Canada, including but not limited to:

(Please print name of camp or activity)

I desire to participate in the above activities sponsored or organized by The Alpine Club of Canada. I understand that in order for The Alpine Club of Canada to accept my application to participate in the above activities, I must agree to be bound by this Release, Waiver and Assumption of Risk.

In consideration of The Alpine Club of Canada accepting my application, and my being permitted to participate in the above activities, I must agree to this Release, Waiver and Assumption of Risk.

I waive any and all claims I may now and in the future have against, and release from all liability and agree not to sue The Alpine Club of Canada, Her Majesty the Queen in Right of Canada as represented by Parks Canada and their officers, employees, mountain guides, instructors, leaders (volunteer or other), agents or representatives (collectively the "Released Parties") for any personal injury, death and property damages, expenses or loss sustained by me as a result of my participation in the above activities due to any cause whatsoever, including, without limitation, negligence, breach of statutory duty including duties arising from occupier's liability legislation, on the part of the Released Parties but is not intended to affect any rights I have under Provincial Worker's Compensation legislation.

I am aware that there are serious dangers and risks inherent in travel to and in mountains and other remote places (mountaineering, hiking, mountain camping, skiing, sport climbing and mountain flying), including but not limited to the following:

1. **MOUNTAIN TERRAIN** - The mountainous areas used for activities sponsored or organized by The Alpine Club of Canada have steep slopes that in their natural state have many dangerous obstacles and hazards that may be hidden or covered by snow in winter, or grass and foliage in summer. Some of these obstacles and hazards include loose rocks, glacier crevasses, ice and snow cornices, tree walls, tree stumps, creeks, rocks and boulders, forest deadfalls, holes and depressions below the snow or ground surface, volcanic activity, water quality, and varying and difficult conditions. These mountainous areas also have dangerous man-made obstacles and hazards which may include logging and other roads, steep road banks and washouts, fences and other structures. The mountainous areas used for activities sponsored by The Alpine Club of Canada may not have been climbed, traveled or skied previously, and are not regularly patrolled or examined. Because of forested areas, wild rugged terrain or bad weather, participants may become lost or separated from their guides or companions. Communication in this mountain terrain is always difficult and, in the event of an accident, rescue and medical treatment may not be available.
2. **AVALANCHES AND ROCKFALL** - Avalanches can frequently occur in mountain terrain. Avalanches may be caused by natural forces including steepness of slopes, snow depth, instability of the snow-pack or changing weather conditions. Losses can occur from the actions of participants, helicopters or the failure, for any reason, of the Released Parties to predict whether the terrain is safe for travel or skiing or where an avalanche may or may not occur. Participants can be overcome by rockfall at any time, without warning.

Warning: By Signing This You Are Waiving Your Legal Rights and You Give Up the Right to Sue

3. MOUNTAIN FLYING - Additional risks are posed by airplane and helicopter travel in mountainous areas and in varying weather conditions.
4. WEATHER - Weather conditions may be extreme and can change rapidly without warning.
5. THE RELEASED PARTIES AND OTHER PARTICIPANTS - The conduct, including negligence, of the Released Parties, the guides, and other staff of The Alpine Club of Canada and or other participants.
6. CLIMBING ON NATURAL OR ARTIFICIAL WALLS - Activities may include the use of natural or artificial structures to allow climbing, some hazards of which include protection or hardware failure, rope failure or structural failure of the natural or artificial surface.
7. EQUIPMENT FAILURE - Equipment used as an aid or safety measure while climbing or skiing (including hardware or ropes) may fail or break.

I accept all the inherent risks of the above activities and the possibility of personal injury, death, property damage or loss resulting there from.

I agree that I will be fully responsible for all costs and expenses which may be incurred in providing any special services to myself, outside of regular services agreed to or provided by the Released Parties in connection with the activities, and without limiting the generality of the foregoing, I agree to be responsible for and to pay for all and any costs of rescues, special travel, medical attention or other special outlay for myself personally, and to reimburse the Released Parties and its staff for all costs of these services as may be incurred by them for my benefit or at my request.

I acknowledge that the enjoyment and excitement of this activity is derived in part from travel to and in climbing environments, mountains and other remote places, mountaineering, rock climbing, ice climbing, camping, skiing, sport climbing and mountain flying, and that the inherent risks of these activities contribute to such enjoyment and excitement.

In entering into this agreement, I am not relying on any oral, written or visual representations or statements made by the Released Parties, including those in the camp prospectus or other brochures, to induce me to participate in the above activity.

I confirm that I am the full age of majority or, in the alternative, I have indicated that I am the guardian of the minor participant named, and that I have read and understand this agreement prior to signing it and agree that this agreement will be binding upon me (as participants or guardians), my heirs, next of kin, executors, administrators and successors.

SIGNED THIS _____ DAY OF _____, 200__.

Participant's Signature	Participant's Printed Name	In the Presence of: Witness Signature	Witness' Printed Name
1. _____	_____	_____	_____
2. _____	_____	_____	_____
3. _____	_____	_____	_____
4. _____	_____	_____	_____
5. _____	_____	_____	_____
Guardian's Signature: (if Participant is a Minor)	Guardian's Printed Name:	In the Presence of: Witness Signature	Witness' Printed Name:
_____	_____	_____	_____

**RELEASE OF LIABILITY, WAIVER OF CLAIMS,
ASSUMPTION OF RISKS AND INDEMNITY AGREEMENT**
(hereinafter the "Release Agreement")

**BY SIGNING THIS DOCUMENT YOU WILL WAIVE OR GIVE UP CERTAIN
LEGAL RIGHTS, INCLUDING THE RIGHT TO SUE OR
TO CLAIM COMPENSATION FOLLOWING AN ACCIDENT**

PLEASE READ CAREFULLY!

SIGNATURE OF CLIENT/STUDENT

Name	Last		First		Initial
	Address				
	Street				
	City	Prov/State	Country	Code	
Email Address					
Date of Birth	Year	Month	Day	Age	
	Telephone		Office	Mobile	
	Home				
Trip Date	Year	Month	Day		

TO: _____; _____;
ASSOCIATION OF CANADIAN MOUNTAIN GUIDES; HER MAJESTY THE QUEEN IN RIGHT OF CANADA; and their directors, officers, employees, guides, agents, independent contractors, subcontractors, representatives, successors and assigns (all of whom are hereinafter collectively referred to as "**the Releasees**")

WILDERNESS ACTIVITIES

In this Release Agreement, the term "**wilderness activities**" shall include but is not limited to: alpine skiing, nordic skiing, telemark skiing, snowboarding, hiking, touring, mountaineering, rock climbing, ice climbing, expeditions, trekking, glacier travel, and all activities, services and use of facilities either provided by or by the Releasees including orientation and instructional sessions or classes, transportation, accommodation, food and beverage, and water supply, and all travel by or movement around helicopters, other aircraft, snowcats, snowmobiles or other vehicles and camping or overnight stays in the outdoors.

In this Release Agreement, the term "**Negligence**" includes the failure by the Releasees to use such care as a reasonably prudent and careful mountain guide/instructor would use under similar circumstances, or breach of any other duty of care imposed by law.

I AM AWARE OF THE RISKS, DANGERS AND HAZARDS ASSOCIATED WITH WILDERNESS ACTIVITIES AND I FREELY ACCEPT AND FULLY ASSUME ALL SUCH RISKS, DANGERS AND HAZARDS AND THE POSSIBILITY OF PERSONAL INJURY, DEATH, PROPERTY DAMAGE OR LOSS RESULTING THEREFROM.

NOTICE TO SNOWBOARDERS AND TELEMAR SKIERS - INCREASED RISK

Unlike alpine ski boot/binding systems, snowboard, and some telemark boot/binding systems are not designed or intended to release and will not release under normal circumstances, thus increasing the risk of not surviving an avalanche.

NON-SCHEDULED OR EMERGENCY EVACUATION, RESCUE OR FIRST AID

I acknowledge and agree that all expenses associated with non-scheduled or emergency evacuation, rescue or first aid will be my responsibility and will not be covered by the Releasees.

**RELEASE OF LIABILITY, WAIVER OF CLAIMS,
ASSUMPTION OF RISKS AND INDEMNITY AGREEMENT
(hereinafter the "Release Agreement")**

**BY SIGNING THIS DOCUMENT YOU WILL WAIVE OR GIVE UP CERTAIN LEGAL RIGHTS, INCLUDING THE
RIGHT TO SUE OR TO CLAIM COMPENSATION FOLLOWING AN ACCIDENT**

PLEASE READ CAREFULLY!

SIGNATURE OF CLIENT/STUDENT

ASSUMPTION OF RISKS – AVALANCHES, ALPINE TERRAIN, WILDERNESS TRAVEL, WEATHER

I am aware that participation in wilderness activities involves many risks, dangers and hazards. Avalanches occur frequently in the terrain used for wilderness activities and may be caused by natural forces or by persons travelling through the terrain. I am aware that the Releasees may fail to predict whether the terrain is safe or whether an avalanche may occur. The terrain used for wilderness activities is uncontrolled, unmarked, not inspected, and involves many risks, dangers and hazards in addition to that of avalanche. These may include, but are not limited to: cornices; crevasses; cliffs; trees, tree wells; tree stumps; forest dead fall; creeks; rocks; rockfall; boulders; holes and depressions on or below the snow surface; variable and difficult snow conditions; effects of high altitude including pulmonary edema and cerebral edema; equipment failure; encounters with dangerous or poisonous flora and fauna; impact or collision with other persons; becoming lost or separated from one's party or guide; negligence of other persons; and **NEGLIGENCE ON THE PART OF THE RELEASEES, INCLUDING THE FAILURE BY THE RELEASEES TO TAKE REASONABLE STEPS TO SAFEGUARD OR PROTECT ME FROM THE RISKS, DANGERS AND HAZARDS OF WILDERNESS ACTIVITIES.** Communication in the alpine terrain may be difficult, and in the event of an accident or illness, rescue, medical treatment and evacuation may not be available or may be delayed. Alpine weather conditions may be extreme and can change rapidly and without warning. Disease may arise from the increased difficulty in maintaining personal hygiene.

RELEASE OF LIABILITY, WAIVER OF CLAIMS AND INDEMNITY AGREEMENT

In consideration of the Releasees allowing me to participate in wilderness activities as defined in this Release Agreement, and for other good and valuable consideration, the receipt and sufficiency of which is acknowledged, I hereby agree as follows:

1. **TO WAIVE ANY AND ALL CLAIMS** that I have or may in the future have against the Releasees and **TO RELEASE THE RELEASEES** from any and all liability for any loss, damage, expense or injury including death that I may suffer, or that my next of kin may suffer as a result of my participation in wilderness activities, **DUE TO ANY CAUSE WHATSOEVER, INCLUDING NEGLIGENCE, BREACH OF CONTRACT, OR BREACH OF ANY STATUTORY OR OTHER DUTY OF CARE, INCLUDING ANY DUTY OF CARE OWED UNDER ANY APPLICABLE OCCUPIER'S LIABILITY LEGISLATION ON THE PART OF THE RELEASEES, AND FURTHER INCLUDING THE FAILURE ON THE PART OF THE RELEASEES TO TAKE REASONABLE STEPS TO SAFEGUARD OR PROTECT ME FROM THE RISKS, DANGERS AND HAZARDS OF WILDERNESS ACTIVITIES REFERRED TO ABOVE;**
2. TO HOLD HARMLESS AND INDEMNIFY THE RELEASEES from any and all liability for any property damage or personal injury to any third party resulting from my participation in wilderness activities;
3. This Release Agreement shall be effective and binding upon my heirs, next of kin, executors, administrators, assigns and representatives, in the event of my death or incapacity;
4. This Release Agreement and any rights, duties and obligations as between the parties to this Release Agreement shall be governed by and interpreted solely in accordance with the laws of the province where the wilderness activities take place and no other jurisdiction; and
5. Any litigation involving the parties to this Release Agreement shall be brought solely within the province where the wilderness activities take place and shall be within the exclusive jurisdiction of the Courts of that province.

In entering into this Release Agreement I am not relying on any oral or written representations or statements made by the Releasees with respect to the safety of wilderness activities, other than what is set forth in this Release Agreement.

I CONFIRM THAT I HAVE READ AND UNDERSTOOD THIS RELEASE AGREEMENT PRIOR TO SIGNING IT, AND I AM AWARE THAT BY SIGNING THIS RELEASE AGREEMENT I AM WAIVING CERTAIN LEGAL RIGHTS WHICH I OR MY HEIRS, NEXT OF KIN, EXECUTORS, ADMINISTRATORS, ASSIGNS AND REPRESENTATIVES MAY HAVE AGAINST THE RELEASEES.

Witness Signature
Please Print Name

Signature of client/student
Date
Signature of Parent or Guardian if under age 19

MEDICAL INFORMATION FORM

Name	<small>Last</small>	<small>First</small>	<small>Initial</small>
Date of Birth	<small>Year</small>	<small>Month</small>	<small>Day</small> <small>Age</small>

EMERGENCY CONTACT

NAME		<small>Relationship</small>
TELEPHONE	<small>HOME</small>	<small>Office</small> <small>Mobile</small>

MEDICAL INFORMATION

ALLERGIES	
MEDICATIONS	
MEDICAL CONDITIONS	
FAMILY DOCTOR	<small>Phone</small>
MEDICAL INSURANCE NUMBER AND CARRIER	
IS THERE ANY OTHER HEALTH OR MEDICAL INFORMATION YOU WANT US TO KNOW ABOUT	

APPENDIX J - EXTREME TRAILS INCIDENT REPORTING FORMS

Accident/ Incident Report Form

Please use this form to report accidents/incidents that happen on all Section-sponsored activities and have the Section Chair forward it to the ACC's Executive Director at National Office.

Date of report:		Date of Incident:	
Report completed by:		Address:	
		Phone #:	
Participants:			
Trip Leader:			
Rope Leader:			
Location of Incident:			
Incident Description: (use back of form for more details)			
Other Witnesses:			
Equipment Involved:			
Weather Conditions:			
Person Injured:	Name:	Phone:	
	Address:		
Treatment administered:			
Rescue Description:			

The Alpine Club of Canada



Field Accident Report Form

PATIENT INFORMATION

PATIENT NAME:		sex: _____	age: _____
address:		phone: _____	
health care #:	plan #:	company/instit.: _____	
accident notification to be given to: NAME:		relationship:	phone: _____
address:		phone: _____	
AIRWAY: open <input type="checkbox"/>	obstructed <input type="checkbox"/>	BLEEDING: internal <input type="checkbox"/>	external <input type="checkbox"/>
OBSERVATIONS AT 10 MINUTE INTERVALS			
CONTINUOUS MONITOR	START TIME: _____ HRS	_____ HRS	_____ HRS
Level of conscious. eyes verbal motor			
Respir. rate character			
Pulse rate character			
Pupils (L) size mm reaction			
Pupils (R) size mm reaction			
Skin colour temp			
OVERALL CONDITION: lucid <input type="checkbox"/> stable <input type="checkbox"/> good <input type="checkbox"/> fair <input type="checkbox"/> poor <input type="checkbox"/> life threatening <input type="checkbox"/>			
MEDIC ALERT DETAILS: ALLERGIES:			
MEDS GIVEN:	1) drug	dosage	time
	2) drug	dosage	time
	3) drug	dosage	time

COMPLETED BY: _____

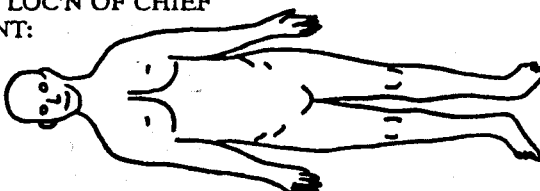
ACCIDENT INFORMATION

DATE OF ACCIDENT:		TIME OF ACCIDENT:	
CURRENT LOC'N OF PATIENT:			
map name #: _____		map sheet: _____ scale: _____ grid ref: _____	
hut <input type="checkbox"/> tent <input type="checkbox"/> bivi <input type="checkbox"/> open <input type="checkbox"/> subalpine <input type="checkbox"/> alpine <input type="checkbox"/> elevation: _____			
PATIENT'S EQUIPMENT COLORS: jacket: _____ helmet: _____ pack: _____ tent: _____			
# REMAINED WITH PT. M: ___ F: ___		Name of support leader with patient: _____	
WEATHER		WIND dir'n _____ strnth _____ TEMP: _____ °C	
SKY:	clear <input type="checkbox"/> ptcl <input type="checkbox"/> ocast <input type="checkbox"/> obscd <input type="checkbox"/> ceiling: _____	visibility in mtrs: _____ in kms: _____	
PRECIP:	type: _____ accum rate: _____		
TERRAIN		slope angle: _____ aspect: _____	
FOREST:	thick <input type="checkbox"/> gladed <input type="checkbox"/> open <input type="checkbox"/> krumholz <input type="checkbox"/> meadow <input type="checkbox"/> heather <input type="checkbox"/> grass <input type="checkbox"/>		
CLIFF:	scree <input type="checkbox"/> ledge <input type="checkbox"/> ridge <input type="checkbox"/> gully <input type="checkbox"/> pinnacle <input type="checkbox"/> col <input type="checkbox"/> hanging <input type="checkbox"/>		
GLAC'R:	crevassed <input type="checkbox"/> ice-fall <input type="checkbox"/> covered <input type="checkbox"/> dry <input type="checkbox"/>	wtrfall: _____ gully <input type="checkbox"/> face <input type="checkbox"/>	
ACCIDENT HIST:	roped <input type="checkbox"/> unroped <input type="checkbox"/> helmet on <input type="checkbox"/> helmet off <input type="checkbox"/> slip <input type="checkbox"/> tumble <input type="checkbox"/>		
rockfall <input type="checkbox"/> icefall <input type="checkbox"/> freefall <input type="checkbox"/> dist. in mtrs.: _____		avalanche <input type="checkbox"/> size: _____	
heat related <input type="checkbox"/> cold related <input type="checkbox"/> ski <input type="checkbox"/> animal <input type="checkbox"/>		what?: _____	
DESCRIBE NATURE OF ACCIDENT/MECHANISM OF INJURY:			
CHIEF COMPLAINT:			
INDICATE LOC'N OF CHIEF COMPLAINT:			
			
EQUIPMENT AT SITE: # tents _____		# sleeping bags _____ # sleeping pads _____	
STOVES: type: _____ #: _____		FUEL AVAIL: litres ___/carts ___	
CLIMBING ROPES: #: _____ diameter: _____		length: _____	
HELMETS? Y N #: _____	CRAMPONS? Y N #: _____	ICE AXES? Y N #: _____	
HARDWARE: hammer? Y N _____		pitons#: _____ nuts#: _____ krabs#: _____	
FIRST AID KIT: complete incomplete (circle)		OTHER: _____	
STABILIZATION OR EVACUATION PLAN (circle)			
<input type="checkbox"/> will remain at current location		require: <input type="checkbox"/> stretcher <input type="checkbox"/> spineboard	
<input type="checkbox"/> will descend/traverse to: (circle location: hut, campsite, road, pass, valley)		destination grid reference: _____	
<input type="checkbox"/> have sufficient clothes	<input type="checkbox"/> have sufficient shelter	<input type="checkbox"/> have sufficient food	<input type="checkbox"/> have sufficient manpower
manpower present is <input type="checkbox"/> experienced <input type="checkbox"/> inexperienced <input type="checkbox"/> mixed			
<input type="checkbox"/> require extra clothes	<input type="checkbox"/> require extra shelter	<input type="checkbox"/> require extra food	<input type="checkbox"/> require extra manpower
- have resources available for fire YES or NO		- are close to suitable helicopter landing site YES or NO	

14.0 REFERENCES

- Alberta Recreation Corridor & Trails Classification System. Government of Alberta. Recreation Branch, Alberta Tourism, Parks and Recreation
- A Guide to Using and Developing Trails in Farm and Ranch Areas. British Columbia, Ministry of Agriculture and Lands.
- ACMG – Association of Canadian Mountain Guides
- ACC – Alpine Club of Canada's Policy Regarding Waiver Administration, Incident Management & Reporting - & Release of Liability, Waiver of all Possible claims & assumption of Risk
- Cross Country Ski Trails. Government of Alberta. Community Recreation and Sport Branch, Alberta Tourism, Parks and Recreation.
- Conflicts on Multiple-Use Trails: Synthesis of the literature and state of the practice. Sponsored by The Federal Highway Administration and The National Recreational Trails Advisory Committee. US Department of Transportation.
- Designing Shared Used Trails to Include Equestrians. Ann M. O'Dell.
- Guidelines for OHV Recreation. Tom M. Crimmins – in association with the National Off-Highway Vehicle Conservation Council
- Guidelines of Snow Avalanche Risk Determination and Mapping in Canada. Canada Avalanche Association
- Land Managers Guide to Snow Avalanche Hazards in Canada. Canada Avalanche Association
- Managing Mountain Biking, IMBA's Guide to Providing Great Riding. IMBA, International Mountain Bicycling Association.
- Pennsylvania Trail Design Manual for Off-Highway recreational Vehicles. Department of Conservation & Natural Resources, Bureau of Facility Design and Construction and Recreation and Conservation
- Rails With Trails: Lessons Learned. Literature Review, Current Practices, Conclusions. U.S. Department of Transportation.
- Railway Association of Canada
- Rail Trails and Safe Communities. Rail to Trails Conservancy.
- Recreational Horse Trails in Rural and Wildland Areas. Design, Construction and Maintenance. Department of Forestry and Natural Resources, Clemson, South Carolina
- Stream Crossing Guidelines – Operational Guidelines for Industry. Alberta Energy and Natural Resources.

- Snowmobile Trail Development Manual. Alberta Snowmobile Association
- Guidelines for Snowmobile for Snowmobile Trail and Signing and Placement. IASA. International Association of Snowmobile Administrators.
- Trails for the Twenty-First Century. Edited by Karen-Lee Ryan. Rails to Trails Conservancy
- Trail Planning and Design, and Development Guidelines. Minnesota Department of Natural Resources - Trails and Waterways Division
- Trail Design Guidelines for Portland's Parks System. Portland Parks & Recreation
- Trail Solutions: IMBA's Guide to Building sweet single track. International Mountain Biking Association
- Understanding Risk Management - A volunteers view of risk management written for the Alberta Snowmobile Association - Clayton Prince, Capri Insurance Services Ltd. 2011
- Whistler Trail Standards, Environment and Technical Trail Features. Resort Municipality of Whistler