



Saskatoon Berry Production Manual

Purchase the print version of Saskatoon Berry Production Manual for \$15.
Buy it on-line www.rtw.ca/b238

Saskatoon Berry Production Manual



Robert Spencer

Linda Matthews

Bob Bors

Clarence Peters

Purchase the print version of Saskatoon Berry Production Manual for \$15.
Buy it on-line www.rtw.ca/b238

Published by:

Alberta Agriculture and Rural Development
Information Management Division
7000 – 113 Street
Edmonton, Alberta
Canada T6H 5T6

Editor: Chris Kaulbars
Graphic Designer: John Gillmore
Page Production: J.A. Serafinchon

Copyright © 2013. Her Majesty the Queen in right of Alberta (Alberta Agriculture and Rural Development). All rights reserved.

No part of this publication may be reproduced, stored in a retrieval system or transmitted in any form or by any means, electronic, mechanical, photocopying, recording or otherwise without written permission from the Information Management Division, Alberta Agriculture and Rural Development.

No Endorsement Given: This publication should not be taken as an endorsement by Her Majesty the Queen in right of Alberta of the products or services mentioned herein.

Disclaimer: Responsibility for interpretation or application of the content contained in this publication rests with the user. Information in this publication is provided solely for the user's information and while thought to be accurate, is provided strictly "as is" and without warranty of any kind, either express or implied. Her Majesty, the publishers and contributors to this publication, and their agents, employees or contractors will not be liable to you for any damages, direct or indirect, or lost profits arising out of your use of this publication.

ISBN 978-0-7732-6101-3
Printed in Canada

Copies of this publication may be purchased from:

Publications Office
Alberta Agriculture and Rural Development
Telephone: 1-800-292-5697 (toll free in Canada) OR call 780-427-0391

See the website: www.agriculture.alberta.ca/publications for information about other publications, CD-ROMs and DVDs.

Purchase the print version of Saskatoon Berry Production Manual for \$15.
Buy it on-line www.rtw.ca/b238

Acknowledgements

The authors of the *Saskatoon Berry Production Manual* gratefully acknowledge the help and support of others in developing this book:

- Perry Millar
- Anthony Mintenko, Manitoba Agriculture, Food and Rural Initiatives
- Forrest Scharf, Saskatchewan Ministry of Agriculture
- Dr. Ken Fry, Olds College
- Greg Pohl, Canadian Forest Service
- Nathan and Gillian Spencer
- Saskatchewan Cultural Industries Development Fund
- Saskatchewan Publishers Group
- Saskatchewan Ministry of Agriculture

Thanks are also extended to the many contributors of photos for this publication. The photo credits acknowledging the providers are listed with each of the images in the book.

Special Acknowledgement

Alberta Agriculture and Rural Development would like to acknowledge the significant foundational work of the University of Saskatchewan and its Domestic Fruit Program towards the Saskatoon berry industry and the development of this resource.

Contents

Introduction	1	Seed-propagated plants and juvenility	14
Biology	3	Clonal plants and precocity	15
Vegetative and reproductive buds	3	Cultivars	17
Primary bud break	3	Cultivar descriptions	17
Secondary bud break	6	Honeywood.....	17
Leaves	6	JB30.....	18
Flowers and fruit.....	6	Martin.....	18
Pollination	7	Nelson.....	19
Propagation	9	Northline.....	19
Rooting ability and stock plant etiolation.....	9	Pembina.....	20
Stool bed preparation	9	Smoky.....	20
Softwood cuttings	10	Thiessen	21
Mist bed structure.....	11	Other named cultivars	21
Misting schedule.....	12	Most commonly planted cultivars	22
Tissue culture	13	Orchard Establishment	25
Seedling plants versus clonally propagated plants	13	Climatic considerations.....	25
Plant variability between a seedling orchard and a clonal orchard.....	13	Site selection	25
Degree of variability among seedlings.....	14	Topography	25
		Row orientation.....	26
		Soil.....	26
		Shelterbelts	26
		Water availability.....	27
		Planting time	27
		Hardening off plants.....	28
		Pre-planting preparation	28
		Planting.....	28
		Traditional planting.....	29
		Deep planting: an experimental method	29
		Deep planting: open furrow method.....	29
		Calculating number of plants.....	30

Cultural Practices	33	How much to prune and when.....	51
Water management	33	Dormant season.....	52
Drip irrigation	33	Bud break.....	52
Buried drip irrigation lines	35	Non-dormant pruning.....	52
Dryland orchards	35	Pruning recommendations for	
Fertility	36	Saskatoon berry growth phases	52
Soil fertility program	36	Plant establishment phase: first or second	
Soil pH	37	dormant season.....	52
Iron chlorosis/lime-induced chlorosis.....	37	Training phase: non-fruiting years.....	53
Soil salinity.....	38	Maintenance phase: fruiting/reproductive	
Tissue analysis and plant nutritional status	38	years.....	54
Nutritional deficiency symptoms	38	Rejuvenation phase of overgrown	
Weed control	40	hedgerows.....	55
Cultivation	40	Advantages of burning.....	57
Herbicides.....	40	Winter Hardiness and Frost	
Mulching.....	40	Tolerance	61
Grass, cover crops and mowing	41	Winter hardiness.....	61
Pruning	43	Frost tolerance and injury symptoms ..	61
Why prune fruit shrubs	43	Diversity	62
Pruning basics for fruit production	43	Pests and Diseases	63
Equipment and supplies.....	43	Pest and disease management	63
General pruning practices.....	44	Pest management practices	63
Saskatoon berries in the wild.....	45	Pest management systems	63
Why prune Saskatoon berries	45	Conventional pest management system	63
Pruning objectives for commercial		Organic pest management and production	
Saskatoon berry production	45	system	64
Effects of pruning	46	Integrated pest management system.....	64
Basic pruning cuts and techniques	48	Insect pests	64
Removal cuts	48	Pests that feed on buds, flowers	
Heading cuts	49	and fruit	64
Growth habits of Saskatoon berries	50	Apple curculio	64
Branching habits of Saskatoon berries	50	Cherry shoot borer.....	66
Suckering habits of Saskatoon berries	51	Hawthorn lacebug.....	67
Fruiting habits of Saskatoon berries	51	Hawthorn weevil.....	68
		Leafrollers, numerous species.....	69

McDaniel spider mite and two-spotted spider mite.....	70	Processing.....	102
Saskatoon bud moth.....	71	Fresh product	102
Saskatoon sawfly	73	Freezing	102
Tarnished plant bug/Lygus bugs	75	Value-added products.....	102
Woolly elm aphid and woolly apple aphid	76	Food development centres	103
Diseases.....	79	On-farm food safety	104
Bacterial blast	79	Marketing.....	105
Blackleaf/witches' broom.....	79	Markets.....	105
Brown fruit rot or mummyberry	81	U-pick or pick-your-own	105
Cytospora canker and dieback	81	Farmers' markets	105
Entomosporium leaf and berry spot.....	82	Farm gate sales	106
Fireblight	85	Wholesale	106
Powdery mildew.....	87	Restaurants and hotels	106
Saskatoon juniper rust	87	Processors.....	107
Harvest	89	Exporting	108
Harvesting	89	Health/nutritional benefits.....	108
Ripening	89	Glossary	109
Uneven ripening	90	References	110
Hand harvesting	91	Appendix.....	111
Pre-picking.....	91		
Pick-your-own or U-pick.....	91		
Mechanical harvesting.....	94		
Choosing the right harvester.....	95		
Upright harvesters.....	97		
Sideways harvester.....	97		
Post-harvest	99		
Post-harvest deterioration	99		
Field heat.....	99		
Harvest timing to reduce cooling requirements.....	100		
Removing field heat.....	100		
The sorting line.....	100		

Introduction

Saskatoon berries have been a part of the Canadian prairie landscape and culture for generations and generations. Over the last 30 or more years, a sizable industry has developed around this traditional prairie fruit. In addition, a significant amount of research and experimentation accompanied this industry development.

This manual represents a comprehensive resource for new and existing Saskatoon berry growers. It delves into the biology of the plant, both from a basic, whole plant level through to a detailed examination of how the plant will respond to practices such as pruning.

The process of propagation is outlined, including a comparison of seedling versus vegetatively propagated material. The manual compares the various commonly grown cultivars for various characteristics and takes growers through orchard establishment and cultural practices for the maintenance of a healthy orchard. There is also a comprehensive outline of pruning techniques, including how pruning affects an orchard and when pruning should be carried out.

Because plant health is a concern for all growers, the various common diseases and pests of Saskatoon berries are outlined, complete with colour photos for identification according to different symptoms.

Once the Saskatoon berry crop is ripe, growers need to focus on harvest and post-harvest management concepts as well as basic marketing. These sections in the manual provide the practical information needed for growers to succeed in these areas.

The information provided in the Appendix is supplementary resource material that can be accessed at any time.

This manual can be used as a comprehensive informational guide for new growers or for those establishing an orchard from the ground up. It will also be a valuable reference tool for growers with specific needs.

Biology

Saskatoon berry plants are 1 to 5 m tall (3 - 16 ft.) shrubs with alternately arranged buds and leaves. Flowers and fruit form in clusters on the branches. Plants may be 3 to 6 m (10 - 20 ft.) wide if left unpruned.

The reddish purple to black, fleshy, berry-like fruit contains several seeds. Branches are smooth with chocolate brown colouring, and twigs are reddish brown.

Vegetative and reproductive buds

An understanding of the bud stages is important for the proper timing of sprays for pest management (see Appendix 1.11). Knowing the bud stages of the crop is also significant for predicting and understanding frost damage as well as the timing of harvest operations.

During the first two development years of plants growing from suckers or root cuttings (clonal plants), all the alternately arranged buds produced on new shoots are juvenile tissue or leaf or vegetative buds. During the first three to four years of seedling plant development, all the buds produced on new shoots are juvenile tissue. Once the clonal or seedling plants have passed the juvenile stage of development, all the buds are mixed fruit-leaf buds, and the plants will begin to produce fruit in addition to leaves.

Primary bud break

Plants break bud in early spring. Initial, or primary, bud break, which occurs from late April to early May, produces the inflorescence and two or three basal leaflets. The time period for the bud stages described in Table 1 is approximately two to three weeks in an average year, but cold or warm spring temperatures can cause this period to vary.

Saskatoon berries are prone to uneven ripening, which may be due to uneven bloom time. It is therefore possible to have some buds in different stages on the same bush, with the buds on the south side more advanced than those on the north side and growth on outside branches more advanced than inside ones.

Also, budding in different varieties and in orchards in different locations may not occur at the same time (see chapter on Orchard Establishment). When estimating the bud stage for the crop, it is important to judge what stage most of the buds are in.

Table 1. Stages of Saskatoon berry bud and inflorescence development

Bud Stage

1. Dormant bud
 Buds as they appear over winter.
 Bud scales closed.
 No sign of opening or breaking dormancy.

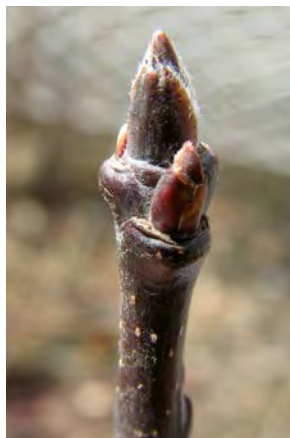

2. Silver tip
 Indicates a break in dormancy.
 Dense, silver, hairy tip emerging from apex of bud scales.

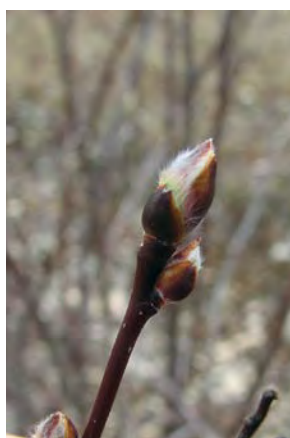

3. Green tip
 First sign of individual basal leaflets emerging from apex of mixed fruit bud and showing distinct separation.
 Difficult to distinguish due to hairy leaflets.



Bud Stage

4. Full green
 Bud scales expelled, first sign of all the basal leaflets that remain tightly folded over the flower buds.



5. Tight cluster
 Basal leaflets open and unfold displaying the full tight cluster of individual flower buds.

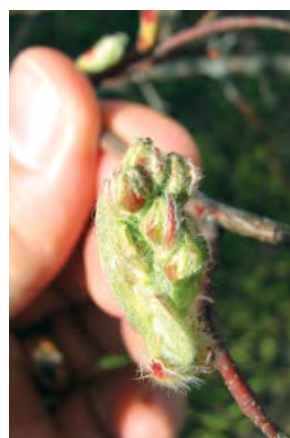

6. Pink or white tip
 Pink tips of petals (some clones are pure white) appear at the apex of individual florets.
 Bud cluster expands to form a loose inflorescence.

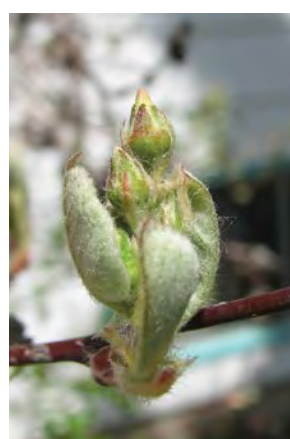

Table 1. Stages of Saskatoon berry bud and inflorescence development

Bud Stage	Bud Stage
<p>7. Balloon</p> <p>Petals expanded but remain closed over the floral cup.</p> <p>Inflorescence almost fully extended.</p> <p>Anthers and stigma protected and hidden.</p>	<p>9. Petal fall</p> <p>Petals expelled from floral cup.</p> <p>Sepals (calyx) fully exposed.</p> <p>Undeveloped fruit.</p>
<p>8. Full bloom</p> <p>Petals fully expanded and fully open.</p> <p>Anthers and stigma displayed.</p>	



Photos: Robert Spencer

Secondary bud break

Secondary bud break occurs just after petal fall when vegetative shoots extend to increase the size of the plant. These vegetative shoots are produced from axillary buds at the base of one or more basal leaflets on the dominant fruiting inflorescence.

Leaves

Leaves are simple, with smooth, rounded margins at the base and serrated teeth at the apex. Leaves are variable in size, ranging from 1 to 5 cm (0.5 - 2 in.) in length (Figure 1).

Flowers and fruit

White (and occasionally pink) flowers are 8 to 12 mm (0.3 - 0.5 in.) across. They are arranged in what is described as a reduced panicle, a terminal bud that opens first (followed by those on the lateral branches) and has an occasional branching habit.

Individual flowers are held on a stalk within the cluster. Each flower has 5 petals with a green sepal positioned between each petal, 5 pollen receptors

known as stigmas and 20 pollen-producing anthers (Figure 2). Saskatoon berry plants produce flowers from early May to early June on wood that is at least one-year-old.

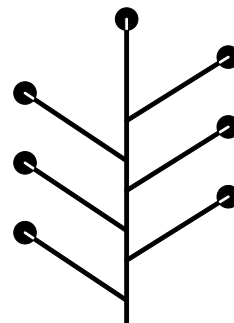

Figure 2. Reduced panicle: buds or flowers open from top to bottom.

The fleshy purple fruit sometimes has a whitish bloom and is a round, berry-like pome (fruit with a central core containing seeds) with several seeds (Figure 3). Individual fruit size varies from 6 to 16 mm (0.2 - 0.6 in.) across, and the size is relative to the number of developing seeds (ovules). Large-sized fruit has more seeds per berry.



Figure 1. Saskatoon berry leaf has serrated teeth towards leaf tip on a Smoky cultivar. *Photo: Bob Bors*



Figure 3. A slight whitish bloom can be seen on this cluster of mature Thiessen fruit. *Photo: Bob Bors*

Saskatoon berry fruit has three stages of development that exhibit a sigmoidal (“S” shaped) growth pattern. During stage one, fruit growth begins slowly, then shows an increase; stage two, fruit growth is fairly constant; stage three exhibits rapid or exponential growth.

Pollination

Pollination is achieved by the transfer of pollen from the anthers to the stigma in the same flower. Wild plants exhibit two types of flowers: narrow, deep floral cups, which may favour self-pollination, and wide, open shallow floral cups, which may not favour self pollination.

Studies at the University of Saskatchewan determined that the flower structure encourages insect pollination and that flowers are predominantly self-pollinated; however, cross-pollination does occur.

Floral scents differ from cultivar to cultivar, and these scents determine the type of pollinators attracted to the flowers. Some florets are scentless while others are strongly scented, either sweet scented or foul scented.

Moonlake, for example, is a sweet-scented cultivar that attracts an abundance of pollinators, including many types of bees. A carrion-scented variety, which is covered with flies during flowering, has been encountered in the Qu’Appelle Valley of Saskatchewan.

Buds to berries

First bud break

- flowers open
- basal leaflets open just prior to petal tips emerging

Second bud break

- leaf buds elongated and cylindrical and lie flat against the stem
- leaves occur singly or alternately on stem

Leaf shape

- circular or slightly ovate
- margins serrated or singly toothed; teeth most pronounced at top leaf

Flowers

- 5 green sepals and 5 white petals with 10 to 20 stamens and a central pistil
- clustered along a central stem; cluster called a raceme
- easily killed by frost

Fruit

- botanical name: a pome
- frosts soon after flowering may damage immature fruit
- bloom or waxy covering
- stalk (pedicel) 1 cm (0.4 in.)
- clusters (racemes) hold 3 to 18 berries
- ripen 6 to 8 weeks after flowering
- single berry:
 - 78 % to 81 % water
 - 19 % sugar
- benzaldehyde produces the characteristic flavour and fruit fragrance

Propagation

Most orchardists do not find it economical to propagate their own plants because the process requires special equipment, skills and time. Furthermore, some Saskatoon berry varieties are protected by agreements with nursery associations such as the Canadian Ornamental Plant Foundation.

While this section is a guide for nurseries, it is hoped that the average grower will recognize the level of expertise required and be willing to buy plants from specialized propagators. This section will also help growers understand what it is they are buying – be it cuttings or tissue culture plantlets – and the advantages and disadvantages of each.

For growers, having plants that are uniform in size and shape is important for mechanical planting. Uniform fruit and ripening date are also important for mechanical harvesting, while fruit consistency is important for processing. To achieve these necessary features, the vegetative propagation of superior varieties is recommended, as opposed to propagation using seedlings.

Softwood cuttings can be the most economical method of vegetative propagation. However, tissue culture is the preferred method of vegetative propagation to obtain large quantities of disease-free plants. With the possible exception of Northline Saskatoon berries, it is not worth grower time and effort to grow from seed because the variability in seed-grown plants means many will not be suitable for commercial purposes (see the section on Seed-propagated Plants later in this chapter).

The Northline exception

It is rare in the world of fruit varieties to have a variety true from seed.

In the early days of the Saskatoon berry industry, many growers planted seedling orchards and were disappointed by the lack of uniformity. At Paul Hamer's Saskatoon Farm near Calgary, Alberta, researcher Bob Bors inspected several acres of Northline seedling orchards that were uniform. Today, the Saskatoon Farm only uses seed from orchards that grow Northline isolated from all other varieties.

Rooting ability and stock plant etiolation

The rooting ability of plants is improved when cuttings are obtained from etiolated tissue, a process where stock plants grow in the absence of light. Cuttings are grown in a stool bed, which is prepared by cutting a Saskatoon berry shrub to ground level and covering it with a black polyethylene tent. New shoot growth is allowed to grow under the cover for four to six weeks, and then light is introduced to allow the plants to re-green.

Stool bed preparation

1. Cut dormant mature shrubs (older than three years) to ground level in early spring.
2. Cover the cut shrubs with 6 mil black polyethylene supported with wire hoops to form a tunnel or tent structure.
3. Ventilate the polyethylene tent with a chimney constructed by taping black plastic pipes 5 cm (2 in.) in diameter to a bamboo stake; secure the apparatus in the centre of the polyethylene tent.



Plant cut to soil line; it will be covered with black plastic tent.



Black tent covering plants cut to soil line.

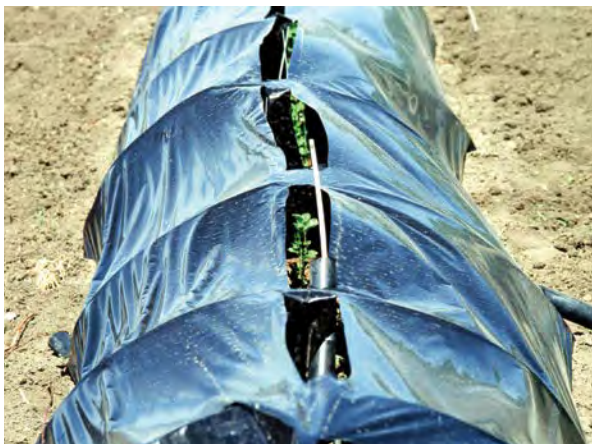

Cut-out rectangles for re-greening plants – new shoots from these plants will be good softwood cuttings, capable of creating roots.

Figure 4. Stool bed process. *Photos: Rick Sawatzky.*

4. Place plastic pipe ventilation devices at the base of the tent.
5. Allow etiolated growth to reach approximately 10 cm (4 in.) in length (approximately 4 to 6 weeks) before it is allowed re-green.
6. Re-green by cutting small windows in the north side of the tent so that direct sunlight does not reach the etiolated growth.
7. Remove the new green shoots after a week and prepare the softwood cuttings.
8. Remove the plastic tents from the stock plants or they will overheat.

Softwood cuttings

Softwood cuttings taken from etiolated tissue are capable of growing roots. Here is the recommended procedure.

1. Immediately place the cuttings in water to ensure they remain turgid (firm and fluid-filled).
2. Take the cuttings to a potting area when as many as needed have been gathered.
3. Dip the cut end in 3,000 to 10,000 ppm liquid rooting hormone (IBA) or Number 2 or 3 of powdered rooting hormones.
4. Place the cuttings in Spencer-LeMaire RootTrainers or other deep containers filled with well-drained rooting medium such as Promix-1 or Sunshine #1. Deep containers will direct the new growth downward.
5. Immediately place the cuttings into a mist bed (instructions below). Cuttings will root by August. Then, growers have three options:
 - a. Plant the rooted cuttings into the field in late August, and keep the transplanted cuttings well watered and free of weeds.
 - With the arrival of cold weather, mulch the cuttings with peat moss and wood chips.
 - Secure the area with wire mesh to prevent rodent damage.

- b. *Alternatively*, remove the plastic covering from the mist bed (below) and overwinter cuttings in it.
- c. *Or*, move the cuttings to a special holding area for the winter, for spring planting.

Mist bed structure

A mist bed supplies cuttings with bottom heat to accelerate rooting and enough moisture to prevent dehydration (see Figure 5).

Growers will need the following materials to build a mist bed:

- a concrete or wood frame (do not use pressure-treated or creosote-treated wood) – growers can design the dimensions to suit their own needs

- polyethylene or shade cloth to make a cover
- mist nozzles to provide the moisture
- a solenoid valve and controller to automate mist cycles
- a heating cable to provide bottom heat
- a thermostat to control the temperature of the heating cable
- a water source such as a hose bib
- timers that will automatically turn the system on and off for an intermittent period – these timers are obtained from greenhouse supply companies and are not the same type as used for irrigation
- copper tubing and a length of garden hose

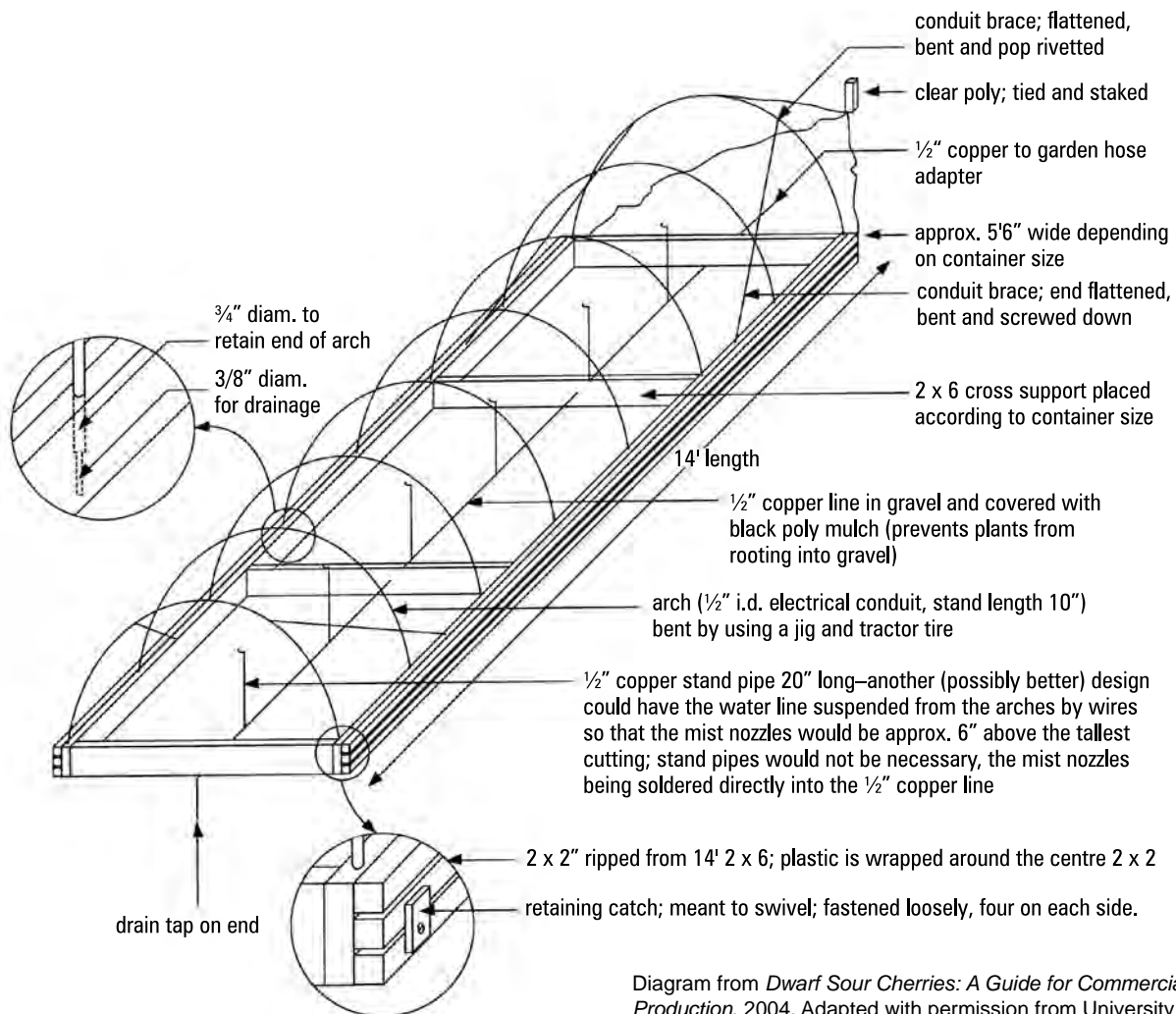

Diagram from *Dwarf Sour Cherries: A Guide for Commercial Production*, 2004. Adapted with permission from University of Saskatchewan Extension Press.

Figure 5. Mist bed.

Water flows continuously to a solenoid valve that is controlled by two clocks wired in series. After flowing through the solenoid valve, water travels through a garden hose to the mist bed location where it flows into a copper tube running the length of the bed. The water is emitted through brass mist nozzles inserted into the tubing.



Greenhouse interior mist bed with heating coils covered by sand, which helps spread heat evenly. *Photo: Bob Bors.*



Outdoor mist beds with shade cloth and aluminum hoops. *Photo: Robert Spencer.*

Figure 6. Mist beds.

Misting schedule

When propagating for trials at the University of Saskatchewan, the following mist bed spray schedule was used. Because several other species are propagated in the same unit, this set-up has not been specifically tailored to any particular fruit crop.

When using a mist tent, it is important to control overheating by ventilating the tents. Raise the polyethylene covering at the sides of the mist tent near the staked ends, and do not allow the temperature in the mist bed environment to exceed 40°C (105°F).

Table 2. Misting schedule

Weeks	Misting Amounts
1 - 4	Mist cuttings for 20 seconds every 5 minutes, 24 hours a day.
5 - 8	Reduce the mist frequency to 20 seconds every 7 minutes, 24 hours a day.
After week 8 until well rooted	Reduce the mist frequency to 20 seconds every 10 minutes during daylight hours only. Continue misting at this frequency until the cuttings are well rooted.
After well rooted	Remove polyethylene cover and set the mist clocks to water the cuttings twice a day. See the previous Softwood Cuttings section for instructions on planting outdoors.
Every week the plants are in the mist bed	Fertilize the cuttings with a dilute solution of 20-20-20 soluble fertilizer. Sanitize the cuttings with Rocal or Skyclean disinfectant to prevent algae growth.

Tissue culture

Tissue culture or micro-propagation refers to *in vitro* culture of plant tissue. Micro-propagated plants are produced in sterile conditions on an artificial growing medium, which rapidly produces large amounts of genetically identical, disease-free planting stock.

While the traditional method of making cuttings works well in early summer, tissue culture allows propagation to be done year-round, and thus, it is possible to propagate large numbers of plants on a yearly basis. This feature is the main reason for using tissue culture plants.

The Saskatoon berry nursery industry does not have a disease-free certification program, but putting plants into tissue culture assures the nursery operators that no diseases can infect them because all plants going into tissue culture are surface sterilized. If a diseased plant slips by and is placed in tissue culture, the plant usually performs poorly and is discarded. The tissue culture process removes almost all insects, mites, viruses, bacteria and fungi, making tissue culture stock a source of disease- and pest-free material for propagation.

However, just because a plant came from tissue culture does not mean it is now immune to diseases. It can still contract diseases like any other plant once it is in the field.

Micro-propagated shrubs are available for sale as plugs (container grown) and as potted plants. Often, tissue culture companies sell plugs (also called liners) wholesale to smaller nurseries, which then plant them in larger pots and grow the plants for an extra year or more. The larger bushes cost more and may not be economical for professional orchardists, but may be attractive to gardeners who only want a few plants that are more mature.

Tissue culture plants are available from licensed propagators (see Appendix 1.3).

Seedling plants versus clonally propagated plants

Plant characteristics between seedling plants and clonally propagated plants differ.

Because seedling plants are derived from sexual recombination during the process of sexual reproduction, seedling Saskatoon berry plants are

not genetically identical. Although the differences between some seedling plants may be subtle or almost invisible, plants grown from seed are not true to type. Each has a unique genetic makeup, even though the seeds may have come from the same row of plants or even from the same plant. Some seedling plants, however, may be markedly different in outward appearance.

Clonally propagated plants are derived from micro-propagation, softwood and hardwood cuttings, layering, root division and grafting. These plants are identical to the parent plant. Any variation among clonally propagated plants in the field results from environmental factors.

Plant variability between a seedling orchard and a clonal orchard

An orchard planted with seedlings will exhibit greater variation in plant characteristics and growth – either subtle or drastic – than an orchard planted with clones.

Most seedling orchards will have greater variation in anthesis (flowering period), fruit size, colour, quality and maturation than a clonal orchard.

Coming in from the wild

“Most cultivars of Saskatoon berries grown at present are based on selections from the wild – someone walking in the bush noticed a plant that was quite superior to its neighbours in fruit production, dug up a sucker, and brought it home. Only a few named cultivars have been the result of deliberate selection from test plots.” Martin was developed from a Thiessen seedling selected by the Saskatchewan horticulturalist Dieter Martin (Sara Williams)

Parkhill and Success likely are hybrids of *Amelanchier stolonifera* and *A. alnifolia*. All other cultivars are hybrids of *A. alnifolia* (B.J. Weir).



Figure 7. Differences in maturation can be seen in the different heights of these Smoky seedlings.
Photo: Clarence Peters

While differences in leaf size and colour are inconsequential, differences in plant size and plant shape will have an effect on orchard management. Variation in plant height and shape in a hedgerow will require additional pruning and shaping to accommodate mechanical harvesting.

However, fruit variability in a seedling orchard is more critical to the orchardist than plant variability. Increased variation in fruit characteristics, especially in size and weight of fruit, has been noted on seedling plants compared to cultivars or plants derived from controlled crosses.

In mature seedling orchards with obvious differences in fruit quality among the plants, some of the plants may be ignored by U-pick harvesters. Variable fruit maturation dates between seed-propagated plants will require additional harvest dates, resulting in additional harvest costs. There may also be increased handling costs and losses from fruit culling due to variation in fruit maturity, size and colour.

Slight or marked variation in fruit flavour is also found in a mature seedling orchard. Differences in fruit sugar content and acidity may not be apparent to the orchardist but are of utmost importance to fruit processors. In some mature seedling orchards, the fruit may be too variable to satisfy the requirements of processors, thereby limiting market opportunities for producers (U-pick, farmers' markets).

Clonally propagated orchards should avoid many of the above issues; however, over the long term, there should be little difference in total yield between seedling and clonal orchards, provided seedlings are from a reliable and isolated source.

Degree of variability among seedlings

The degree of variability among seedlings depends on the characteristics of the source plant (clone or cultivar), the amount of cross-pollination occurring at the source and, most importantly, whether the variety is itself a hybrid between two plants with many differences.

For example, if a short, small-berry bush were crossed with a tall, large-fruit bush, the hybrid may be medium height with medium-sized fruit. However, it is also possible for the hybrid bush to be a small, medium or tall bush that produces small, medium or large fruit. And the genetics within the seeds from the hybrid bush might produce any combination of bush size and fruit. When adding the genetic possibilities for early and late fruiting, different flavours and other characteristics, a grower could have an orchard with wide variation that may be challenging to manage.

If the original plant from which seeds were gathered was the result of many generations of shrubs that have exhibited little variation or if the original plant were hybridized with similar plants, a grower could expect the resulting seedlings to be rather uniform. Observations of seedling orchards of Smoky and Northline are much more uniform, while Thiessen and Martin display wider phenotypic variation. Bearing this factor in mind when buying plants, it is worthwhile to inquire whether the plants are clones or seedlings.

Seed-propagated plants and juvenility

Seed-propagated plants pass through three phases of development:

- an immature or juvenile growth phase with no fruit bud production
- a brief transitional growth phase where fruit bud production begins
- a mature growth phase where the plants fruit readily.

Besides lacking reproductive capability, juvenile plants are also smaller in size than mature plants and may have larger, hairy, uniquely shaped leaves.

A feature of seed-propagated plants is that they never lose their juvenility at the base of the plant. If seedling plants are pruned to the base of the plant (to the root crown), as is done in renewal pruning or the complete takedown of a hedgerow, the new replacement shoots produced from the base of the plants will display the same juvenile characteristics as before the takedown. This characteristic will result in a delayed return to fruit production, which can have a financial effect.

Clonal plants and precocity

Although seed-propagated plants pass through the three phases described above in an orderly manner, clonal plants exhibit varying growth stages that depend on the growth stage of the source material. In general, clonal plants are more precocious, that is, they begin to produce fruit readily one to two years sooner than seed-propagated Saskatoon berries.

Cultivars

Saskatoon berry cultivars were selected from the wild for desirable fruit and/or plant characteristics: fruit size, yield, flesh colour, flowering time and harvest date. Taste attributes such as sugar content and acidity were also noted. Plant size also varies among cultivars.

Cultivar descriptions

The following guidelines were applied in the descriptions below:

- **Height:** mature trees
- **Yield:** varies from year to year – low yield 2,250 kg/hectare (2,000 lb./acre), high yield 6,730 kg/hectare (6,000 lb./acre)
- **Taste:** determined by sensory analysis

Characteristics	Features
-----------------	----------

Honeywood	
-----------	--

Fruit	<ul style="list-style-type: none"> • deep blue with dark purple skin when ripe • fruit size 13 to 15 mm (0.5 - 0.6 in.) • full flavoured, tangy • very high yield • large fruit clusters
Bush	<ul style="list-style-type: none"> • height: 5 m (16 ft.) • spread: 4 m (13 ft.) • upright, spreading structure • low suckering
Uses	<ul style="list-style-type: none"> • fresh eating, processing
Other features	<ul style="list-style-type: none"> • blooms later than other cultivars thereby potentially avoiding damage by spring frosts • uneven ripening characteristics make it more suitable for U-pick orchards



Photo: Bob Bors

Characteristics	Features
-----------------	----------

JB30	
------	--

Fruit	<ul style="list-style-type: none"> • deep blue when ripe • average fruit size 17 mm (0.7 in.) • wild flavour • high yield
Bush	<ul style="list-style-type: none"> • height: 5 m (16 ft.) • spread: 6 m (20 ft.) • compact bush • low suckering
Uses	<ul style="list-style-type: none"> • fresh eating, processing
Other features	<ul style="list-style-type: none"> • compact bush, large fruit



Photo: Jarvis Blushke

Martin	
--------	--

Fruit	<ul style="list-style-type: none"> • deep blue skin when ripe • fruit size 15 mm (0.6 in.) or larger • excellent flavour, considered fresh and juicy • medium yield • more uniform ripening within fruit clusters
Bush	<ul style="list-style-type: none"> • height: 3 m (10 ft.) • spread: 4 m (13 ft.) • round bush • moderate suckering
Uses	<ul style="list-style-type: none"> • fresh eating, processing
Other features	<ul style="list-style-type: none"> • more uniform ripening • Saskatchewan selection, Thiessen parentage



Photo: Bob Bors

Characteristics	Features
-----------------	----------

Nelson	
--------	--

Fruit	<ul style="list-style-type: none"> • deep blue skin when ripe • fruit size 13 mm (0.5 in.) • tangy flavour, acidic • fleshy fruit
Bush	<ul style="list-style-type: none"> • height: 4.5 m (15 ft.) • spread: 4.5 m (15 ft.) • uniform growth habit
Uses	<ul style="list-style-type: none"> • fresh eating, processing
Other features	<ul style="list-style-type: none"> • some resistance to juniper rust • flowers and fruits about one week later than other cultivars; may avoid spring frosts



Photo: Bob Bors

Northline	
-----------	--

Fruit	<ul style="list-style-type: none"> • deep blue skin when ripe • fruit size 16 mm (0.6 in.) • full flavoured, sweet • very high yield • fruits at a younger age than other cultivars
Bush	<ul style="list-style-type: none"> • height: 4 m (13 ft.) • spread: 6 m (20 ft.) • upright, spreading structure • high suckering
Uses	<ul style="list-style-type: none"> • fresh eating, processing
Other features	<ul style="list-style-type: none"> • suitable to both hand and mechanical harvesting • suggested to have very uniform seedling plants



Photo: Bob Bors

Characteristics	Features
-----------------	----------

Pembina	
---------	--

Fruit	<ul style="list-style-type: none"> • deep blue when ripe • average fruit size 14 mm (0.5 in.) • full flavoured, tangy to moderately sweet • high yield • slightly oval fruit produced on long clusters
Bush	<ul style="list-style-type: none"> • height: 5 m (16 ft.) • spread: 5 m (16 ft.) • upright, slightly spreading structure • produces few suckers
Uses	<ul style="list-style-type: none"> • fresh eating, processing; ornamental
Other features	<ul style="list-style-type: none"> • low suckering habit makes it suitable for home gardens



Photo: Bob Bors

Smoky	
-------	--

Fruit	<ul style="list-style-type: none"> • deep blue when ripe • average fruit size 14 mm (0.5 in.) • mild, sweet flavoured; described as fleshy • very high yield
Bush	<ul style="list-style-type: none"> • height: 4.5 m (15 ft.) • spread: 4.5 m (15 ft.) • upright, spreading structure • suckers profusely
Uses	<ul style="list-style-type: none"> • fresh eating, processing
Other features	<ul style="list-style-type: none"> • blooms later than other cultivars thereby potentially avoiding damage by spring frosts



Photo: Bob Bors

Characteristics	Features
-----------------	----------

Thiessen	
Fruit	<ul style="list-style-type: none"> • deep blue when ripe • average fruit size 17 mm (0.7 in.) • excellent flavour, described as fresh and juicy • high yield • uneven ripening
Bush	<ul style="list-style-type: none"> • height: 5 m (16 ft.) • spread: 6 m (20 ft.) • round bush • low suckering
Uses	<ul style="list-style-type: none"> • fresh eating, favoured by processors
Other features	<ul style="list-style-type: none"> • uneven ripening characteristics makes it more suitable for U-pick orchards • early flowering makes it susceptible to damage from spring frosts



Photo: Bob Bors

Other named cultivars

Table 3 below describes some other named Saskatoon berry cultivars that are available but are not as commonly grown as those described above.

Table 3. Comparison of some less frequently grown Saskatoon berry cultivars

Cultivar	Fruit Size	Flavour	Yield	Characteristics
Moonlake	16 mm (0.6 in.)	sweet and mild	medium	sporadic production
Parkhill*	medium	sweet and mild	medium/low	smaller bush with Entomosporium resistance.
Regent	13 mm (0.5 in.)	high sugar, mild	medium	good ornamental value
Thiessen RS	15 - 18 mm (0.6 - 0.7 in.)	good flavour	high	low growing

*Yield varies from year to year – low yield: 2,250 kg/hectare (2,000 lb./acre), high yield: 6,730 kg/hectare (6,000 lb./acre). Adapted from Guide to Fruit Production 2007 and Prairie Plant Systems Inc. 2006.

Ornamental Saskatoon berry cultivars

Altaglow and Paleface are two ornamental Saskatoon berry cultivars. These erect shrubs grow in a pyramidal shape to about 7 m (22 ft.) in height. They are not self-pollinating but are readily pollinated by blue-fruited cultivars. The berry is white when ripe and about the same size as the blue Saskatoon berries. Though edible, the fruit is rather bland. Their best feature is the brilliant foliage in fall: it changes from green to purple to red and then to yellow.

Most commonly planted cultivars

When choosing a cultivar, it is important to consider the harvesting method (see the Harvest and Post-Harvest chapters) and what the crop will be used for. It is also important to consider the typical flowering and harvest dates of the various cultivars.

To mitigate risk (spring frost, variable yields, etc.), it is often recommended that growers consider planting more than one cultivar. This approach spreads out the flowering and harvest period and can prevent a complete loss in the case of crop failure.

In general, the top three cultivars on the prairies are Northline, Thiessen and Smoky. Preferences and reasons for choosing cultivars vary from farm to farm and grower to grower.

Many growers prefer Northline because the plants are less expensive when grown from seed. Its smaller bush with many suckers means growers can use a sideways harvester. Northline also requires less pruning because growers want the rows to grow wide for using the sideways harvester. Firm fruit, whether hand-picked or harvested mechanically, does not tear as much as other varieties, which reduces the amount of rot that can set in during processing. Firm fruit also enhances pie quality.

Thiessen is known for its large berries. A fast growing, upright plant, Thiessen can only be mechanically harvested with an upright harvester. For a hand-pick or U-pick operation, the larger berries mean people can fill their buckets faster. Because the berries are softer than other varieties, they are better for blending and making sauces, salad dressing or juice. The large berries are impressive in pies. Growers who grow cultivars other than Thiessen suggested that its fruit was larger because of extra water, which they felt reduced the flavour.

Growers of Smoky mention flavour as the reason for growing them. Since Smoky was the first Saskatoon berry cultivar, there are many customers who are familiar with it and ask for it. The bush habit is similar to Northline.

Parkhill was noticed in 2009 and 2010 as having superior resistance to Entomosporium. In the past, its resistance was noted in reports of the Native Fruit Development Program. In 2010 at the University of Saskatchewan, it was the best looking of all the varieties during that wet season. The 7-year-old bushes were smaller than most, being about 1 m (4 ft.) tall. However, the bush has a nice shape for better air penetration and ease of harvesting. It could be an ideal selection for homeowners.

All growers felt the cultivars they grow are the best tasting.

Grower feature

Jarvis Blushke's JB30

JB30 is one of the more recent cultivars to be introduced commercially, and it has burst onto the horticultural market after years as a best-kept secret.

JB30 is a selection collected 25 years ago from the North Saskatchewan River Valley by Jarvis Blushke of Langham, Saskatchewan, where one of the first neighborhood U-pick operations for Saskatoon berries had been established.

Subsequently, the Native Fruit Development Program of the University of Saskatchewan, under Richard St-Pierre, compared 15 mature cultivars at 2 sites over a 5-year period. The study evaluated yield, fruit size, ripening (evenness and date) and shoot growth.

The cultivars with high yield and large fruit size: JB30, Thiessen and Martin. The cultivars with earliest fruiting time: JB30, Thiessen, Martin and Honeywood.

Upon completion of the study, JB30 was recommended for commercial propagation.

Orchard Establishment

Climatic considerations

The Canadian prairies are situated in the northern temperate climatic zone with a short growing season. Temperatures can fluctuate from 40°C (104°F) in summer to minus 40°C (minus 40°F) in winter. However, rapid temperature fluctuations such as those found in the Chinook region of the Canadian prairies are often more damaging to orchards than the slower, more measured, changes in temperature extremes.

In spite of these extremes, a grower can establish a successful long-term venture by carefully selecting an orchard site with optimum conditions and by using good cultural practices.

Site selection

The selection of an appropriate site is of the utmost importance since the site enhances productivity, thereby increasing profit margins. A life expectancy of 25 to 35 years for the orchard should be sought

as a minimum goal. A good site with optimum conditions will yield a long-term, productive and profitable orchard.

Orchards will be exposed to a variety of climatic conditions, and it is important to limit the effects of climate. When choosing an orchard site, a grower should consider the following factors:

- topography
- soil type
- protective shelter (shelterbelts, natural or planted)
- availability of adequate quantity of quality water

Topography

The ideal orchard site has a northeast or east slope, preferably overlooking a river or body of water. This location provides adequate air and water drainage because dense air at ground level flows downhill into a frost pocket, and excess water drains to the base of the slope.



Figure 8. An ideal site for an orchard – the Saskatoon Farm orchard, near Dewinton, AB, is on a plateau below a shallow hillside and overlooks the Highwood River. *Photo: Bob Bors*

Another ideal site faces northeast or east with a more moderate slope ranging from 1 to 5 per cent. This slope aspect offers protection from sunscald, winter damage, frost damage, heat and drought stress, and provides calmer conditions for pollinator activity.

Other suitable orchard sites are flat terrain or flat terrain at the top of low, gently sloping hills, with a slope direction between north and east and northwest.

Avoid southeast and west slopes because these exposures often lack adequate snow cover in winter and are exposed to the predominant desiccating west and northwest winds. Southeast and west slopes also induce early flowering, which increases the potential for frost damage and increases the risk of sunscald injury.

Avoid northern slopes because they do not provide adequate sunlight for photosynthesis. Finally, avoid plantings at the bottom of slopes because these areas are susceptible to frost damage and waterlogged soil.

Row orientation

Row orientation will influence light penetration and air circulation. Saskatoon berries planted in a north-south row orientation receive maximum light penetration into the canopy whereas rows planted in an east-west row orientation receive maximum air flow, due to the prevailing winds.

However, if growers have sloped land, it is best to plant in such a way as to allow cold air to drain out of the orchard, while minimizing soil erosion and making mechanical harvesting easier. This approach may involve orienting rows diagonally down the slope, rather than planting following the contour or planting rows directly down a steep slope.

Soil

In general, cultivars appear tolerant of most types of prairie soils. A soil pH range of 6.0 to 7.5 is ideal for growing Saskatoon berries. However, Saskatoon berries have been grown successfully in fine clay soil with a pH of 8.

Avoid planting in saline or waterlogged soil because the root systems are sensitive to poorly drained or wet soil.

Soils

Sandy soils drain quickly, are easily worked and warm up faster in the spring. They have low moisture-holding capacity, low nutrient-holding capacity and are subject to wind erosion.

Clay soils have high moisture-holding and high nutrient-holding capacity. They warm up slowly in the spring and may have poor drainage.

Fruit production guides universally discourage growing fruit crops in clay soil. However, deep clay soils with low amounts of rainfall, such as the soils found on much of the prairies, may be fine for fruit growing. However, growers should avoid fruit growing in pure clay soils in regions where rainfall is plentiful or on the Canadian Shield where the soil is shallow.

The following characteristics describe ideal soil:

- well drained
- sandy loam or loam texture
- no perennial weeds
- a pH near 7.0 (6.0 - 7.5 to maximize nutrient availability)
- organic matter levels between 2 to 3 per cent (very important with clay or sandy soil)

The type of soil affects the water and nutrient-holding capacity, which, in turn, determines the irrigation schedule and fertilization requirements. Sandy soils drain faster than clay soils, thus requiring more frequent irrigation.

A complete soil test is recommended before making a final decision for an orchard site. See Appendix 1.2.1 for a list of companies that perform soil tests.

Shelterbelts

Shelterbelts create beneficial micro-climates for fruit production on the prairies and should be considered an essential part of any prairie fruit orchard. Multi-row shelterbelts provide the best protection, and each unit of shelterbelt height gives 3 to 5 times its

height in terms of distance of protection (e.g., 1 m (3 ft.) gives 3 - 5 m (10 - 16 ft.) of protection).

Ideally, shelterbelts should be in place before planting and should surround the orchard. However, crops such as corn and tall sunflowers can be used for temporary shelterbelts. Artificial shelterbelts (windbreaks) can be used in the absence of trees (see Figure 10).

On the lower part of a slope, shelterbelt plantings should be spaced an adequate distance away from the orchard plantings to permit ample air drainage, so the shelterbelt planting does not act as a cold air trap.

Place shelterbelts perpendicular to prevailing winds to reduce wind speed, which, in turn, controls erosion, reduces the wind chill factor and desiccation (drying), and prevents mechanical wounding or damage caused by rubbing or breaking branches. Reducing wind speed also increases the amount of snow accumulation in winter, which contributes to stored soil moisture and in summer, enhances flower pollination by insects.

Shelterbelts should not be completely solid as some amount of airflow is beneficial. If possible, place gaps or spaces in shelterbelts to allow air into and out of fields.



Figure 9. A mature shelterbelt protects a mixed-crop orchard at Sweet Berry Meadows near Nipawin, SK. *Photo: Bob Bors*



Figure 10. An artificial shelterbelt at the CACDI Irrigation Demonstration Farm at Lethbridge, AB. *Photo: Troy Ormann*

Plant rows of fruit trees 15 m (50 ft.) away from shelterbelts. This distance provides adequate turning space for mechanical harvesters and prevents damage to fruit tree branches from large snowdrifts that accumulate on the leeward side of shelterbelts.

Consult provincial government contacts for current information on shelterbelt planning and planting.

Water availability

When assessing potential orchard sites, growers need to consider the availability of water. Will the orchard require irrigation? If so, how easy will this procedure be? What are the costs? Is there a good supply of quality water at the location?

Watering practices and irrigation will be discussed in more detail later in this manual (see the section on Water Management in the Cultural Practices chapter).

Planting time

Plant plugs or container-grown shrubs. Choose healthy plants with a well-developed root system. Planting can occur in spring, in August or in the dormant (early spring or late fall) season. Dormant plant material is usually planted in early spring or late fall.

Plugs planted in August should have fertilizer withheld so as not to encourage late-season growth.

Continued production of top growth means the plants may not become fully dormant and may result in winter dieback.

Some nurseries take actively growing greenhouse plants that have been growing during the winter and place them in cold storage for six weeks before delivery. This method induces dormancy in the plants and, in effect, provides them with a “winter rest.”

When planted in the spring, these plants break dormancy, put on more shoot growth and will produce a larger plant at the end of the growing season (sometimes twice as large as those without the cold treatment). There is an additional cost for this handling, and growers have to arrange for the cold storage treatment in advance.

Actively growing plants that have recently come out of tissue culture are not as expensive as dormant plants, but they may or may not put on additional shoot growth during the first growing season. However, these plants usually make extensive root growth during this period.

Hardening off plants

Plants grown in a greenhouse need to be gradually exposed to outdoor conditions for two reasons: to prevent them from getting sunburned and to reduce the stress that occurs when they are placed in the field. The glass of a greenhouse blocks most ultraviolet (UV) light, so the plants need some time (approximately four to five days) to build protective waxy layers on their leaves. If, however, the plants are fully dormant (no leaves), there is no need to harden them off, and this step can be skipped.

One hardening-off method is to place the greenhouse-grown plants in a shady area at first and then gradually move them into the sun. Another method is to cover them with a shade cloth, such as Reemay, and gradually increase the amount of time they are uncovered.

On an overcast day, the plants can be left out in the open and unprotected, but a bright, sunny day may cause sunburn. Sunburned leaves, or parts of leaves, become white or faded for a few days, after which they usually turn brown.

Pre-planting preparation

When preparing to plant, ensure the planting site is both free of perennial weeds (see the section on Weed Control in the Cultural Practices chapter) and has been worked sufficiently to ensure the planting bed is ready to receive transplants. This preliminary work may involve one to two years of site and soil preparation.

Skimping on preparation can cost growers in terms of time and effort required in future years and may well make the difference between having a thriving, established orchard or a weak, problem-plagued one.

Planting

In wild stands, Saskatoon berry plants normally grow in dense thickets where new plants are established from rhizomes originating from the crown of the mother plant. Cultivars, particularly seedlings, retain a strong tendency to sucker, but plants produced from tissue culture or etiolated cuttings are similar, and their suckering response is more moderate.

Growers may choose to use the traditional planting method of preparing a hole (see the following Traditional Planting section), or they may wish to consider the experimental method of deep planting (see the Deep Planting section later in this chapter).

Regardless of the planting method, when the shrub is in place, cover the roots with topsoil, pack firmly and water immediately. If drip irrigation tape is set up in the orchard, connect the tape as each row is planted or have a ready supply of water from a hose to water the plants as they go in. It only takes a few minutes of air exposure or contact with dry soil to damage young roots. Also, do not spread out the plugs across the field before planting unless it is a very damp day.

Growers can also use a mechanical transplanter. Transplanters require one or two people, depending on the model, to manually place the plugs into a device that plants at pre-determined intervals. It is important to ensure that machines have been properly calibrated. These machines are never totally accurate for planting depth; therefore, it is best to inspect new plantings and manually replant those not properly planted (see the Planting Recommendations table at the end of this chapter).

Traditional planting

Prepare a hole large enough to accommodate the entire root mass, and plant the shrubs at least 2.5 to 5 cm (1 - 2 in.) deeper than they were in the nursery containers to avoid frost heaving, which is a serious problem in clay and organic soils.

Recommended spacing for the plants within the row is 1 to 1.5 m (3 - 5 ft.) apart. However, the distance between the rows will depend on equipment size and cultural practices:

- Mechanical harvesters require 5 to 6 m (17 - 20 ft.) between rows to avoid harvester damage.
- U-pick orchards can use narrower row spacing, 3.5 to 4 m (12 - 13 ft.), but can be spaced up to 5 m (16 ft.) apart. With narrower row spacings, pruning becomes even more important to provide adequate space for pickers to move freely and to prevent bushes that “loom” over pickers.

Deep planting: an experimental method

The deep planting of crowns along with appropriate pruning procedures produces a multi-stemmed shrub with new shoots originating from the crown (below the soil surface) rather than from rhizomes positioned away from the mother plant.

When Saskatoon berries are deep planted, individual shoots that form the crown are separated below the soil surface and are well spaced at the surface. This method aids pruning and decreases the susceptibility to canker diseases.

It is suggested that growers test a small portion of their plants with deep planting to determine the benefits and disadvantages, based on their soil, site and climatic conditions. Growers may also want to conduct small trials to determine the best technique and correct depth for plant placement for their orchard. Results can be compared to your current planting methods.

Potential advantages to deep planting Saskatoon berries:

- reduces suckering
- maintains individual crowns
- promotes deep, central rooting

- produces a multi-stemmed shrub with shoots originating from the crown (rather than root suckers) when properly pruned
- helps decrease susceptibility to pests and disease

Deep planting of the crown helps maintain separate crowns rather than having the plants form a solid hedgerow (or at least, the method delays the development of a solid hedgerow). Some growers perceive solid hedgerows as a disadvantage.

Certainly, spacing facilitates air movement, which, in turn, may prevent or delay the onset of fungal diseases, such as *Entomosporium* leaf and berry spot and powdery mildew. These diseases establish and perpetuate in a humid microclimate (see the Pests and Diseases chapter).

Separated root crowns also improve the efficiency of commercial over-the-row harvesters since the fish plates are able to close intermittently at the base.

Producing deeply rooted plants with low suckering may also help avoid problems with woolly elm aphids and woolly apple aphids. These pests prefer feeding on shallow-rooted suckers and rhizomes near the soil surface rather than on the main plant and deep roots.

Deep planting: open furrow method

The simplest way to achieve deep planting is to adjust the planter to place the shrubs deeply into the soil. The current recommendation is to place nursery or greenhouse-grown stock 2.5 to 5 cm (1 - 2 in.) deeper into the soil than it was in the pots.

The open furrow system of deep planting is a more long-term method where growers create a narrow trench and place the plants at the desired depth in the trench. Slowly, over several years, the trench in which the plants are placed is filled in.

Open furrows can be made with a variety of equipment:

- potato hilling equipment
- reversed disks and shanks
- modified raised-bed equipment
- modified mouldboard plough
- rototillers with optional hilling blades
- producers' own modified implements

Furrow dimensions:

- depth: 10 to 15 cm (4 - 6 in.)
- width: 0.3 m (1 ft.)
- distance between furrows same as for traditional planting: mechanical harvesters 5 to 6 m (17 - 20 ft.), U-pick orchards 3.5 to 5 m (12 - 16 ft.)

Plant placement:

- Space plants 1 to 1.5 m (3 - 5 ft.) apart.
- Place plants to be grown in lighter soils deeper than those to be grown in heavy soils.
- Place the plants in the furrow with the root crown just above the bottom of the furrow.
- Place container-grown, tissue culture plants or dormant, bare-rooted plants with the natural crown of the plant level with the bottom of the furrow instead of the normal soil level.

Closing the furrow:

- Keep the furrow open until a well-branched stool has developed – two years (or more).
- Allow the closing process to be gradual and occur naturally through erosion and between-row cultivation.
- Avoid closing the furrow too quickly; quick closure may smother the formation of a sufficient number of new basal shoots.
- When the furrow is completely closed, growers should have well-spaced, multi-branched plants, narrow at the base, with the shoots originating well below the soil and the rows free of root suckers.

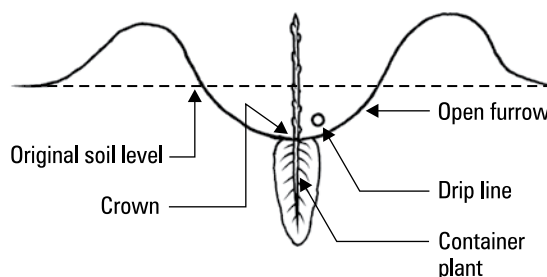

Figure 11. This side-view diagram illustrates the structure of an open furrow deep planting with plant and drip line placed in furrow below original soil level. *Diagram: Clarence Peters*



Figure 12. Early stages of deep planting show open furrows in this recently planted orchard. *Photo: Clarence Peters*

Calculating number of plants

Row spacing and plant spacing will determine the number of plants per hectare or per acre. The number of Saskatoon berry plants required for an orchard is determined with the following formulas:

Plants per hectare

$$\frac{10,000}{\text{between-row spacing in metres} \times \text{between-plant spacing in metres}}$$

Plants per acre

$$\frac{43,560}{\text{between-row spacing in feet} \times \text{between-plant spacing in feet}}$$

Planting Recommendations

Planting method	Depth	Plant spacing	Distance between rows	
			Mech. harvest	U-pick
Traditional planting	2.5 - 5 cm (1 - 2 in.) deeper than containers	1 - 1.5 m (3 - 5 ft.)	5 - 6 m (17 - 20 ft.)	3.5 - 5 m (12 - 16 ft.)
Deep planting	2.5 - 5 cm (1 - 2 in.) deeper than containers in 10 - 15 cm (4 - 6 in.) deep furrow	1 - 1.5 m (3 - 5 ft.)	5 - 6 m (17 - 20 ft.)	3.5 - 5 m (12 - 16 ft.)

Cultural Practices

Water management

Water is important for ensuring good orchard establishment, flower bud initiation, fruit sizing and getting consistent yields.

Crops grown on the prairies rely on soil moisture reserves accumulated during the fall and winter seasons and on annual summer precipitation. However, irrigation systems can supplement water in years when there is a spring soil-moisture deficit or inadequate seasonal rainfall.

Regardless of whether or not growers choose to irrigate orchards every year, it is important to supply plants with water during the first three years of establishment. Adequate water is also necessary as fruit filling takes place. The amount of water required by a Saskatoon berry orchard will vary with the year and location, as affected by climate, in-season rainfall and weather, as well as the age and size of the plants within the orchard.

If an irrigation system is planned, have the water source analyzed to ensure the water is suitable for irrigation (Appendix 1.2.1). Consult an irrigation and/or water specialist to interpret the water analysis and assist in designing an appropriate system for the orchard.

On the prairies, water use approval or licensing is required before irrigation water can be taken from any source other than a pond or dugout filled by rainwater or melted snow that has fallen on the grower's property. The construction of ponds, dugouts or dams may also require approval. Obtain permission for water use from the appropriate water regulating authorities (Appendix 1.2.2).

Drip irrigation

Use drip irrigation systems only rather than overhead irrigation, which can spread leaf diseases.

Drip irrigation has a number of advantages over other systems:

- controls the amount and placement of water and minimizes water loss through evaporation, resulting in greater efficiency
- allows development of an irrigation system with a somewhat smaller water source than other systems require
- operates with low water pressure and distributes the water at an even flow rate, reducing the amount of energy required for its operation, which contributes to lower operating and labour costs once the system has been installed
- waters the plants slowly near the root zone, so the foliage remains dry, thus reducing the opportunities for fungal disease development
- reduces weed growth between the rows due to lack of moisture
- can be automated and an in-line fertilizer system can also be installed



Figure 13. Surface drip line. *Photos: Lloyd Hauser*



Figure 14. Inline fertilizer drip system – fertilizer is distributed to the plants through the drip line watering system. *Photo: Bob Bors*

Drip irrigation systems require better quality water than overhead systems because of the small size of the emitters, and depending on the water analysis, pre-treatment of the water may be necessary to filter out debris.

The main components of a drip irrigation system are the head and the distribution network. The head consists of a water source, pump, filter, pressure regulator and pressure gauge, and may also include a water meter, chemical injector and electronic controller.

The pump draws water from the source and feeds the distribution network. A filtration system prevents clogging. Water pressure and emitter output are controlled with a regulator.

The distribution network is made up of the main water line and lateral lines with emitters or lateral drip lines. Lateral lines transport water to the orchard and discharge it at emitter sites (Figure 15).

Routine inspection of the system is required to check for damage from rodents and field equipment.

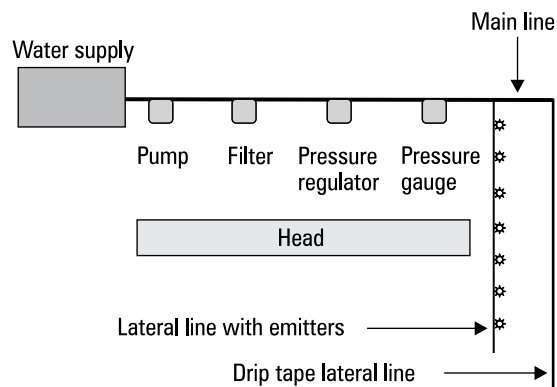

Figure 15. Components of a drip irrigation system.



Figure 16. Rodent-damaged drip irrigation line.
Photo: Robert Spencer

When laying out drip irrigation lines, it is important to ensure that drip emitters are spaced so as to provide adequate water to the plants. Emitter spacing is not standardized for all drip lines.

Choose a spacing that will provide a uniform wetting zone for the plant spacing chosen. Also consider that drip lines will expand and contract due to heating and cooling, causing them to move and potentially shift the wetting zone somewhat.

While a single drip irrigation line may provide sufficient water for smaller, establishing plants, as orchards mature, a second line may be necessary to meet orchard water requirements. This factor needs to be considered in the planning stages so that both system capabilities and water sources are adequate.

Buried drip irrigation lines

The open furrow (deep planting) system limits the use of plastic mulch for weed control since it is difficult to install plastic mulch in a trench. However, buried irrigation systems can help reduce weeds.

Place the drip irrigation lines on one side of the row. Drip lines with proper emitters can be buried as the furrow is closed (see Figure 11). There are several advantages to buried lines:

- less likely to become pinched off when placed in the area between the crown and the root
- are out of the way of pruning devices
- do not wet the soil surface, which reduces weed growth, particularly in a dry year
- reduce surface humidity at the base of the crown, which may help prevent or reduce fungal diseases such as *Entomosporium* leaf and berry spot and powdery mildew

The greatest disadvantage to buried irrigation lines is the difficulty in finding and repairing damaged or plugged emitters and pinched lines. However, pinched lines are more common with above ground lines because these lines have a tendency to become constricted between two crown shoots.

Dryland orchards

Dryland orchards rely on winter snow accumulation and in-season rainfall to meet seasonal water requirements, so dryland orchard practices are focused on conserving moisture. These orchards are riskier, and if moisture conditions become limited, the plants may have sporadic yields. Under prolonged drought, some plants may die or the entire orchard may die.

The following recommendations could be helpful in reducing water needs by maximizing available moisture.

- Plant shelterbelts to trap snow and reduce wind speed (evaporation/transpiration losses).
- Control weeds to decrease moisture losses from competition.

- Avoid grass lanes to prevent moisture losses from competition, although this method may reduce orchard access during wet periods. Ideally, if planting grass, only plant grass species that do not spread into the plant rows and are low water users. Maintain a bare strip of soil out from the plants to reduce competition.
- Water the shrubs for the first *three* years to ensure they are well established; this procedure is imperative if plants are to survive in dryland conditions.



Figure 17. Good weed control. Photo: Lloyd Hausher

Fertility

Saskatoon berries represent a long-term crop that will require added fertilizers to maintain productivity over the life of the orchard. It is important to remember that nutrient requirements will vary from area to area with different soils.

By ensuring that soil nutrient levels are topped up before planting and by applying specific amounts of fertilizer yearly, growers can ensure that adequate nutrients are available to the crop for the duration of its lifespan.

It is important to have soil tested and prepared before planting an orchard. A soil test will provide benchmark information on the nutritional status, soil texture, organic matter, pH and soil salinity levels for the soil within the orchard. It is much easier to amend soil before planting begins, and the following steps will ensure the long-term productivity of the orchard.

Prepare soil for planting:

- perform tillage operations to incorporate debris, control weeds and prepare the planting bed
- add or build up organic matter
- apply the necessary nutrients recommended by the soil test

In general, it is recommended that soils (averaged throughout the depth of the planting bed) contain at least 70 kg actual nitrogen (N)/ha (65 lb/ac), 100 kg actual phosphorus (P)/ha (90 lb/ac) and 400 kg actual potassium (K)/ha (355 lb/ac) before planting Saskatoon berries. These levels will ensure there are sufficient nutrients for the establishing crop.

Logic dictates that since Saskatoon berries are an indigenous crop on the Canadian prairies, the soils are fertile enough to support their growth initially. However, orchard crops need nutritional supplements if they are to remain productive over the entire life of the orchard because as fruit is harvested, nutrients are removed.

In subsequent years after planting, in-row soil testing or leaf tissue analysis can be used to determine nutrient requirements. Leaf tissue analysis is considered by some to be far more reliable than soil samples to determine nutrient requirements (see Tissue Analysis further on in this chapter); however, testing facilities may not always be available, and proper samples must be collected for tests to be accurate.

Soil fertility program

Adequate nutrition is necessary for Saskatoon berry plants of all ages, but during the orchard establishment phase, the plant's ability to access soil nutrient reserves is less than during its mature years. Provided soil fertility is adequate at planting, no additional nutrient application may be required for the first few years; however, this situation can vary depending on the soil and the region. As plants mature, their annual nutrient demand will increase somewhat.

Growers should apply a small amount of nitrogen and some phosphorus (e.g. 11-52-0) at planting. This mix should be added as a liquid fertilizer when watering in transplants. This approach will ensure that the young, establishing plants will have easy access to adequate nutrients as they start to grow.

In subsequent years, fertilizers may be broadcast over the soil surface near the root zone and worked into the soil. Granular fertilizers can also be applied as a band to the base of plant rows, or fertilizer can be supplied to the plants via injection into the drip irrigation system.

It is important to adjust the per-acre-rate of fertilizer to compensate for the smaller area being treated. Guard against an excessive application of nitrogen, especially a late fall application, which would stimulate late season growth and delay dormancy, rendering bushes susceptible to winter injury.

Phosphorus deficiencies are uncommon, and most prairie soils will contain adequate levels of potassium for Saskatoon berry fruit production. Where a potassium deficiency is identified, the plants respond well to field applications of potassium.

Sulfur and most micronutrient fertilizers are unnecessary unless a deficiency is detected.

Currently, recommendations for fertility applications vary. Applications are made to maintain the level of soil fertility in the soil, topping up or replacing those nutrients removed during fruit harvest. As a general rule, growers may apply 33 to 55 kg actual N/ha (30 - 50 lb/acre) and 22 to 44 kg actual P/ha (20-40 lb/acre) as a split application in early May and late June.

Rates should be adjusted when applying as a banded application, depending on between-row spacing. Total application rates can be modified using annual in-row soil testing and/or leaf tissue testing.

Soil pH

The degree of soil acidity or alkalinity is described by the pH scale:

- pH=7 is neutral
- pH<7 is acidic
- pH>7 is alkaline or basic

Soil pH is important because this variable affects the availability of plant nutrients. A range of 6.5 to 7.5 is neutral, and most plant nutrients are available in this range.

As pH moves further away from neutral, nutrients become more or less soluble in soil water and more or less available to plants. Movement toward acidity reduces the availability of the macronutrients phosphorus, potassium and sulfur as well as the micronutrients calcium and magnesium. Movement toward alkalinity reduces the availability of the micronutrients copper, manganese, zinc, boron and iron.

As soil pH changes, there is also the potential for nutrients to become available in toxic amounts, which could harm orchard plants.

Iron chlorosis/lime-induced chlorosis

In balanced pH conditions, plants absorb an adequate amount of iron from the soil to facilitate chlorophyll production. If the soil is too alkaline (basic), the plant may develop iron chlorosis (or lime-induced chlorosis), where the ability of plant roots to take up iron is reduced by an accumulation of bicarbonate ions in the soil. Within the plant, the movement of iron from older tissue to younger tissue is reduced, resulting in a deficiency.



Figure 18. These leaves exhibit typical symptoms of chlorosis. *Photo: Anthony Mintenko*

The most common symptom of this condition is interveinal chlorosis – yellow tissue between prominent green veins. But symptoms can also appear as a range from a slight fading in colour to the complete yellowing of leaves.

Foliar application of chelated iron, soil aeration and soil remediation based on soil test results may alleviate the problem. However, if the soil pH is >8 , it may be very difficult to correct this problem, and growers may want to find a better site for the plants. Soil pH can be reduced very gradually, over time, through the use of acidic fertilizers.

Soil salinity

Soil salinity is determined by measuring the electrical conductivity of a soil. Electrical conductivity (EC) is an estimate of the amount of soluble salts present in the soil solution.

Fruit crops are classified as “sensitive” to salt. Electrical conductivity values of less than 1 dS/m (deciSiemens per metre) are considered acceptable. As the electrical conductivity (dS/m) of the soil increases, there will be reductions in yield, and the health of the plants will be affected.

The soluble salts in prairie soils are primarily composed of sulfates of magnesium and sodium, but most plants do not require sodium and cannot survive in saline soils. When plants absorb too many sodium ions instead of potassium ions, they develop a nutrient deficiency and enzyme inhibition.

Salinity typically occurs in areas with a high water table and where the amount of evaporation is greater than the amount of precipitation. Salinity also occurs in irrigated soils when salts are introduced in the irrigation water and build up in the soil or when poorly drained soil prohibits the effective leaching of excess irrigation water.

If salt damage is suspected, tissue analysis can detect salt injury. Soil testing before planting can determine if a soil is suitable. Note that beans have a similar salt tolerance level to fruit crops, so if beans can be grown in the soil, fruit should also be viable.

Even if growers do not have saline soil, a gradual localized buildup of salt can occur over time, especially with drip irrigation systems. Once or twice a season, it is a good idea to apply excess water to

allow the leaching of salts, but this flushing will occur naturally if there is heavy rainfall. It is also important to use only good quality water for irrigation.

Tissue analysis and plant nutritional status

Tissue analysis is a diagnostic tool that can be used to detect nutrient deficiencies and potential toxicities by showing which nutrients the plant is actually absorbing. A tissue analysis of a plant indicates the nutritional status of the plant, and a tissue analysis of a cross-section of plants establishes the nutritional status of the orchard.

When gathering leaves to determine nutritional status, collect samples from the current season's growth from the mid-section of the plant. Collect the samples in midsummer when active growth and nutrient uptake are occurring and later in the growing season when active growth has stopped, but before the leaves start changing colour.

When sampling to diagnose an existing problem, collect paired samples: one sample from normal foliage and one sample from abnormal foliage.

Nutritional deficiency symptoms

Trees can be inspected visually for nutrient deficiencies (See Table 4), but caution is recommended because deficiency symptoms may be mistaken for disease or insect injury and can vary quite widely. Testing should be done to validate visual symptoms.

Table 4. Nutrient deficiency symptoms

Nutrient	Plant Part	Deficiency Symptoms
Nitrogen (N)	Leaves	Pale green to yellow; first evident in lower/older leaves at the base of shoots
	Fruit	Small and early maturing
Phosphorus (P)	Leaves	Purplish colour; young leaves abnormally dark green; symptoms usually occur early in the growing season
Potassium (K)	Leaves	Symptoms develop first on older leaves at the base of the current season's shoot growth; characterized by marginal scorching
Calcium (Ca)	Leaves	Upward cupping of leaf margins on younger leaves; expanding leaves exhibit uniform veinal and interveinal chlorosis
Magnesium (Mg)	Leaves	Green colour fades at the tips of older leaves, and fading progresses between the veins toward the base and main vein of the leaf, giving the leaves a herringbone appearance
Boron (B)	Leaves	Distorted, may cup or roll downward or develop a thick, leathery texture
	Shoots	Tips cease to grow and die; buds fail to open and die
	Fruit	Gnarled, misshapen, corky tissue
Copper (Cu)	Leaves	Elongated young leaves appear stunted and misshapen; leaves narrow with wavy margins
Iron (Fe)	Leaves	Interveinal chlorosis beginning with terminal leaves and moving to basal leaves
Manganese (Mn)	Leaves	Interveinal chlorosis confined to the leaf margins; appears on the youngest leaves first
Zinc (Zn)	Leaves	Chlorotic tufts of smaller leaves develop at shoot tips; resetting of leaves is the result of reduced shoot elongation

Adapted from Pennsylvania Tree Fruit Production Guide



Figure 19. This orchard is well mulched and has good weed control resulting from Casoron applications. *Photo: Lloyd Hausher*

Weed control

Weeds compete with crops for moisture and nutrients, and can also be alternate hosts for diseases and insects as well as shelter for burrowing pests. Weeds also create a favourable environment for disease and insect development (e.g. reduced air flow results in increased humidity). Weed control can be achieved through a combination of tillage/cultivation, herbicides, mulching, and sowing grass or cover crops and mowing.

Cultivation

For one to two years before orchard planting, cultivate the area in the spring and summer to effectively control perennial weeds. Weakened perennial weeds may attempt to re-establish in the fall, but a fall application of a non-selective herbicide (e.g. glyphosate) will destroy them. It is extremely important to avoid applying chemicals when it is windy and to use chemicals according to the label recommendations.

If the planned orchard area is in grass, spray out row strips and work up that area. Consideration should be given to what is going to be done with the between-row space as the established grass species may not be suitable for orchards and may need to be removed or replaced at a later date.

If between-row spaces are left bare, tillage is a valid weed control option, provided care is taken to keep cultivation shallow and not too close to the Saskatoon plants, as the plants are susceptible to damage.

Herbicides

Newly planted Saskatoon plants are not very competitive and must be protected from weed encroachment. Before planting, growers may apply and incorporate pre-emergent herbicides to provide some residual control of emerging weeds. Applied products will not provide long-term protection, but the use of pre-emergent products, combined with good pre-planting weed control, can keep the weeds down to a manageable level.

Some other cultural methods of weed control will likely be necessary in the first couple of years, as plants become established. Care should be taken to avoid damage to plants.

Herbicide use can make weed control somewhat easier once the plants become established. A small number of chemical products are available for use in Saskatoon berry plantings. Depending on the product, plants must be established for a minimum of one to two years. Most herbicide applications are made to plants in the early spring or when plants are dormant.

Care should be taken when applying herbicides as significant damage can occur if products are applied improperly. Drift, contact with bark and leaves or contact with active plant parts can result in damage. Systemic herbicides, if applied to Saskatoon berry suckers growing between rows, can travel back to the mother bush and cause damage. When applying products to plant rows (banded), rates should be adjusted to compensate for the actual area being treated.

For a list of currently registered products for use in Saskatoon berries, see the information in Appendix 1.12.

Mulching

Using mulch has a number of advantages:

- suppression of weeds
- retention of moisture
- extension of the growing period

- enhanced seedling survival
- protection of irrigation lines

Growers can use organic mulch (bark, flax shives, pine cones, straw, wood chips), black plastic mulch or fabric mulch. Fabric mulch holds up and performs the best over the long term, but for many growers, it is prohibitively expensive. The deep planting method does not allow mulching (see the section on Deep Planting in the previous chapter).

Mulch installation is labour intensive, but once the mulch is in place, weed control operations are decreased. A combination of mulch and trickle or drip irrigation underneath works well for establishing new plantings.

When installing plastic mulch, the drip line is usually placed in the rows beforehand, and the mulch is placed overtop. Some mechanical plastic mulch applicators, such as the one in Figure 20, can also mechanically plant small plugs simultaneously.

In most situations, mulch application is a multi-person job, requiring one person on the tractor and additional people for cutting and burying plastic at the ends of the rows. Plants should be checked after mulch application to ensure they are positioned correctly.



Figure 20. This plastic mulch applicator can also mechanically plant small plugs simultaneously. *Photo: Bob Bors*



Figure 21. Plastic mulch installed at planting in an orchard. *Photo: Lloyd Hausher*

Research conducted by the Saskatchewan Fruit Growers Association and the Agri-Environment Services Branch (formerly the Prairie Farm Rehabilitation Administration – PFRA) demonstrated the benefits of using plastic mulch in berry orchards (see Appendix 1.13).

The use of organic mulches is a common approach that conserves moisture and can suppress weeds somewhat. Mulch is typically applied in a band at the base of the plant row. Care should be taken to ensure that mulch does not cover or damage young plants.

Mulches should be 10 to 30 cm (4 -12 in.) deep and should be at least 20 to 30 cm (8 -12 in.) away from the plants (to protect from rodent damage). Organic mulches may start to break down over time, which can result in a temporary tie-up of nutrients in the soil profile by micro-organisms.

Mulches also have some disadvantages, and some researchers think that leaving the soil bare in the plantation row is best. Organic mulches can provide shelter or protection for small rodents (mice, voles), which nest and/or hide in the mulch and feed on the shrubs. And, these mulches are also a haven for the woolly elm aphid.

Producers should decide whether using mulches or not works best for them and then make appropriate adjustments to their management practices to be successful.

Grass, cover crops and mowing

Cover crops, green manure crops and semi-permanent and permanent grass plantings are effective weed suppressants and also act as management tools for using excess soil moisture

and nutrients. These tools also work to moderate soil temperature. Green manure crops and semi-permanent grass cover add organic matter to the soil when they are cultivated and worked into the soil.

Orchard access during wet weather can be greatly improved, especially on heavy soils, when non-invasive grass cultivars or cover crops are planted between rows. Plant drought-tolerant, non-spreading, clump grass species, such as Sheep's Fescue or hard fescue. These species do not require a lot of moisture to survive and do not require a lot of mowing.

Broadcast seed at approximately 45 kg/ha (40 lb/ac.), and incorporate using a light cultivation. Maintaining a grass-free zone approximately 0.5 m (1.5 ft.) away from both sides of the Saskatoon berry plantings will reduce competition and allow the shrubs to grow to full size.

Cover crops help offset the risk of winter damage, particularly during the third, fourth and fifth years while the bushes are growing rapidly but before they fruit heavily. Winter-damaged bushes produce lush

new growth below the damaged areas of the bush, and during the following winter, this new growth is at greater risk of cold temperature damage than the rest of the bush.

Moisture and nutrient uptake by grass and cover crops has been found to induce earlier dormancy in plants and increase winter hardiness, particularly if growers stop mowing the cover crop in late summer. Once the orchard is established – two to three years after planting – seed the lanes with non-invasive grass.

Thicker or longer grassed areas provide excellent habitats for rodents, which can become pests during winter. Consider mowing to open up the grass canopy to expose rodent pests to predators and to discourage pest populations from becoming established.

In some drier regions or areas, grass can become competitive and can use up vital moisture reserves. Alternative plans need to be considered if moisture is in limited supply.



Figure 22. A wood-chip mulch and grass cover between the rows help suppress weeds and manage moisture.
Photo: Robert Spencer

Pruning

Why prune fruit shrubs

- establish and train new plants
- control plant height, size and shape
- improve plant structure and branching habit
- eliminate or reduce sucker growth
- maintain plant vigour and health
- maintain annual fruit production
- delay plant maturity and extend orchard longevity
- repair damaged plants and rejuvenate old plants
- remove diseased, dying or dead plant material

Saskatoon berry plants are shrubs and require pruning to ensure long-term health and productivity. For commercial producers, pruning serves three purposes:

- increase and stabilize the productive capacity of the plants
- control plant size
- establish and maintain hedgerow architecture to accommodate specific types of mechanical harvesters

For shrubs grown in backyards and in small numbers on acreages, the benefits are the same: pruning helps maintain plant health, vigour and productivity.

Pruning basics for fruit production

Whether pruning a large tree or a small shrub, proper tools are a must. A few general practices relating to pruning will also help maintain the tools.

Equipment and supplies

The tools and equipment required for pruning Saskatoon berry plants on a small acreage include a pruning knife and bypass secateurs for small cuts up to 2.5 cm (1 in.), a two-handed bypass lopper and, occasionally, an adjustable pruning saw for larger cuts. Keep all pruning equipment as sharp as possible to facilitate clean cuts.

For larger orchards, growers will need a pneumatic hand-held pruner (lopper size) with an extension, which makes the pruning procedure much faster and easier. Pruning saws are not normally required if following the recommended renewal pruning regime during the training and maintenance phases of orchard establishment.

Additional equipment, such as a chainsaw and bush cutter, is not required unless the hedgerows have reached full maturity and have been rarely or never pruned.



Figure 23. Pneumatic hand-held secateur. Photos: Clarence Peters and Lloyd Hausher

If growers have a small operation and need to remove suckers to keep the rows narrow, they should use a long sharp spade. In large orchards, use a large sharp disk or similar tillage unit that cuts the lateral roots below ground but does not uproot them. Deep planting, especially in open furrows, and regular sucker removal reduces and all but eliminates wide lateral suckering away from the rows.

Pruning tools

There is a world of difference between pruners (or secateurs), loppers, saws and tools made with quality steel and those of lesser quality. Cheap secateurs may be inexpensive, but are easily bent by the first few pruning cuts on larger branches. Growers will know when they have found good tools because they will not have to replace them. Quality tools pay for themselves in the long run.

General pruning practices

- Prune soft wood and woody stems up to 1 cm (0.5 in.) in diameter with secateurs or pruning shears. Loppers or long-handled pruning shears can cut branches up to 4 cm (1.5 in.) in diameter. A pruning saw is ideal for cutting thick wood and roots. Keep blades sharp to ensure clean cuts.
- Remove diseased or damaged wood right away at any time of year to prevent disease from spreading. When removing diseased wood, cut 30 cm (12 in.) below the infected area or further back to a logical junction point – do not leave a stub.
- Use clean, sharp pruning tools; clean cuts promote the rapid formation of scar tissue.
- Disinfect tools about every 15 minutes when pruning healthy bushes as pruning can spread diseases or viruses that are not easily detected.

Disinfect tools between cuts with full-strength Lysol when pruning diseased branches. You can dip the tool into the Lysol, but using a spray bottle filled with disinfectant is the easiest and fastest method, and the liquid does not spill. Hook the handle of the spray bottle onto a belt or pocket, so the bottle does not have to be carried. Always wipe the tools after dipping or spraying.

Pruning tools can also be dipped into a 1:10 solution of Lysol and water, household bleach and water (with a few drops of soap to act as a surfactant) or 70 to 90 per cent alcohol. Rust is a problem when tools are dipped into water-based solutions, so be

sure to dry the tools thoroughly after use with a soft, oily cloth to help keep them rust free.

Pruning paint on the cuts is not recommended because it can seal in fungal spores or bacteria that may have been on exposed tissues. The paint also creates the ideal moist environment required for disease proliferation. Researchers have found that untreated cuts tend to heal better on their own than if pruning paint is used.

Saskatoon berries in the wild

Wild Saskatoon berry plants produce a strong central leader and narrow, weak secondary branching. Some varieties sucker profusely from lateral rhizomes while others produce few suckers and develop a more tree-like structure, with shoots produced near the crown.

In the wild, Saskatoon berry plants produce most of their fruit from mixed buds on new wood extensions produced in the previous season. However, some fruit is also produced on two and three-year-old wood from mixed buds; these are vegetative buds on spur-like projections (not true spurs) at the base of fruiting inflorescences.

Wild Saskatoon berries naturally mature in 8 to 10 years to a height of 3 to 6 m (10 - 20 ft.). When fully mature, plants cease producing new growth extensions. On mature plants, fruit is produced on mixed basal buds from the spur-like growths on previous fruiting inflorescences.

These natural fruiting and vegetative growth characteristics of wild Saskatoon berries are not desirable for either backyard gardens or commercial production, but proper pruning procedures can alter the growth habits and tendencies of Saskatoon berry cultivars and improve the plant's fruiting habits.

Why prune Saskatoon berries

Saskatoon berries have some specific growth and fruiting characteristics that, when understood, will help growers prune properly. The following discussion provides background on several key pruning topics: basic pruning objectives, how pruning affects Saskatoon berry plants in general, and how pruning can contribute to increased production.

Pruning objectives for commercial saskatoon berry production

The pruning recommendations that follow assume a commercial production and a free-standing hedgerow designed for mechanical harvesting. In most cases, the type of harvester dictates the maximum allowable height and the preferred width and shape of the fruiting hedge. To some extent, all these objectives can be achieved through the use of a proper pruning regime.

Long-term objectives for pruning Saskatoon berries for a commercial operation:

- grow and maintain the plants and hedgerows at an optimum height
- shape the plants and maintain the architecture of the hedgerows to best accommodate mechanical harvesting
- improve the branching habit and strength of branches to reduce mechanical injury from the harvesting operation
- reduce suckering and maintain individual plant crowns
- increase the amount of new fruiting wood and maintain an annual bearing habit
- increase longevity by maintaining plant health and vigour and delaying plant maturity
- increase and maintain a high and predictable annual yield with large, high quality fruit



Figure 24. Severe suckering in row of Smokys due to lack of pruning; row is becoming wider and increasingly dense, which will affect the long-term health of the plants, fruit production and harvesting.
Photo: Clarence Peters



Figure 25. A well-pruned row of Smokys has a narrow base and the interior of the plant is more open, which will enhance the vigour of the plants and ease harvesting. *Photo: Clarence Peters.*

Effects of pruning

The pruning cut triggers a physiological response in the plant cells that influences the growing habits of the plant. The physiological changes affect bud dominance, branching habits, changes in the juvenile and mature states as well as fruiting. Growers can see the effects of these changes in the growth or physical development of the Saskatoon berry plants.

Growers can use important effects of pruning Saskatoon berry plants to their advantage:

Physiological effects

- alters production and distribution of growth regulators, which triggers bud dominance, establishes branching habits and branch angles
- may alter plant's growth state by delaying change from juvenile to mature state or may reverse mature state to juvenile state
- if severely pruned, alters carbon, hydrogen, oxygen, nitrogen ratios and delays onset of fruiting
- if selectively pruned, increases fruit bud development
- regulates fruiting by affecting biennial/annual production

Physical effects

- triggers dwarfing, which can be cumulative if plant is pruned annually

- stimulates temporary and localized growth near pruning cut, but over time, growth will be less than if not pruned
- affects fruiting by delaying onset, decreases total yield while increasing marketable yield, or evens out annual yields by reducing biennial bearing

Dwarfing

The degree of dwarfing is influenced by different factors:

- how early in a plant's development pruning is begun
- the time of year the pruning is done
- the amount of wood removed
- whether or not pruning is done annually and regularly

The long-term and cumulative effect of regular pruning reduces the eventual total mass of both the vegetative growth and root growth, which ultimately has a dwarfing effect.

Growers should not be surprised if pruning appears to have the opposite effect at first, and the pruned plants appear to have increased vegetative vigour. This result is because the pruned plant attempts to restore the equilibrium between vegetative and root mass by producing a flush of new growth. This effect is temporary, and the extra energy required to produce the new growth never completely replaces the original vegetative mass.

The earlier annual pruning is begun in a plant's development, the greater the dwarfing effect. A plant that has never been pruned until it nears maturity exhibits little or no dwarfing effect when a pruning program is begun because the root mass is too vast.

The timing of the pruning operation also affects the amount of dwarfing. Pruning dormant plants in the spring or fall affects vegetative growth initially and reduces suckering. However, late summer pruning has the greatest dwarfing effect, initially, because it starves the root system while the plant prepares for winter, which reduces the vigour of the vegetative growth in the following year.

Plant Configuration

Pruning affects a number of physical attributes:

- plant height

- plant width and shape
- the degree of branching
- the angles at which the branches are attached
- the amount of new wood
- the number of fruiting versus vegetative buds
- the degree of suckering

Pruning alters the configuration of individual plants and the architecture of a hedgerow by permitting growers to control and manipulate the shape of the plants to suit their needs.

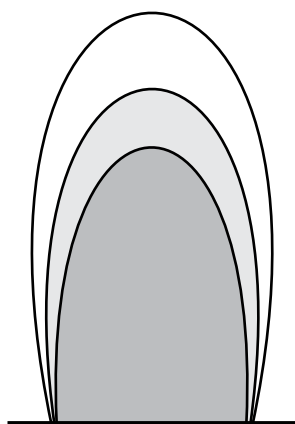

Figure 26. Bad architecture – if regular pruning is neglected, the architecture of the Saskatoon berry plant rows will develop a wide base and excessive height. *Diagram: Clarence Peters*

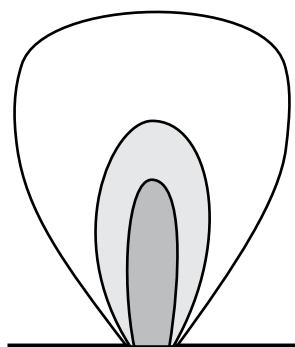

Figure 27. Good architecture – the architecture of a well-pruned Saskatoon berry row resembles a vase: narrow at the base and widening toward the top. *Diagram: Clarence Peters*

The majority of branches on the centre and lower half of a hedgerow produce little, if any, valuable

fruit, and removal pruning and annual thinning stimulate the development of new wood and stronger fruit buds.

Yield and fruit size

Regular and corrective pruning procedures reduce biennial bearing (also called alternate or irregular bearing) – a tendency to overproduce one year and under-produce the following year. Biennial bearing occurs for a variety of reasons: flower loss, early fruit loss, low pollinator activity in cool weather, too little sunshine, variable moisture as well as soil nutrient status. Once triggered, the biennial bearing habit tends to perpetuate itself.

Plant health and vigour

Plant health is sustained when the following problems are addressed:

- diseased, insect-infested, weak, older wood is removed
- suckers and lower branches are taken off, reducing the risk of fungal diseases and wood-boring insects found in the microclimatic zone (high humidity, reduced air movement) around the base of the plant
- shaded growth in the centre and lower portions of the canopy where unproductive wood is produced are pruned
- multiple-branched stems and older wood, which are susceptible to breakage and mechanical harvester damage are cut off

Regular and annual pruning also has the following benefits:

- delays the maturation of a fruiting hedge and maintains its productivity over a longer time
- replaces the oldest portion of growth by replacing it with a flush of new, vigorous vegetative shoots from the root crown, thus increasing the proportion of fruiting wood
- increases the production of side branches (feathering) and improves the structure, framework and strength of individual branches, plants and hedgerows while also reducing stature

Regular and annual thinning increases the penetration and distribution of light throughout the canopy, stimulating the production of vigorous fruit and vegetative buds.

Basic pruning cuts and techniques

When growers have some background on basic pruning practices and the fundamental reasons for pruning Saskatoon berry plants, they can learn and apply two standard pruning cuts and techniques.

The two necessary pruning cuts are *removal* and *heading*:

- removal cuts: eliminate or thin vegetative growth
- heading cuts: promote branching in close proximity to the cut

Removal cuts

In general, removal or thinning cuts on Saskatoon berry plants remove entire branches or growth back to a main branch or the root crown. Removal cuts should be made at the branch collar, a specialized area of tissue that forms callous and scar tissue most rapidly (see Figure 28).

Removing a branch from its base diverts the plant's resources into existing branches and allows greater light penetration and more air movement. Removal cuts are also made when a tree has too many branches, which causes lower yield, poorly coloured fruit and more disease and harvesting problems.

Lateral removal cuts on side branches are used to thin the canopy and to remove other problems:

- wide or low branching, which is unproductive
- injured wood
- narrow or split angles
- diseased or insect-infested wood

A removal cut at ground level can be used to thin the crown in the hedgerow or force a replacement branch from the root crown. Growers should make the cut as close to the ground as possible to prevent infection by dieback disease organisms.

To avoid a replacement shoot where the cut is made, the removal cut should be made as close to the point of origin as possible; for example, remove a sucker well below the ground level with a sharp spade or disc, or expose the rhizome to the crown for removal.

Besides making cuts to shape the shrub and encourage healthy growth, growers may have to

make cuts to remove damaged or diseased wood. If the branch appears diseased, make the cuts at least 30 cm (12 in.) below the diseased section.

Guidelines for making removal cuts:

- Make cuts at a slight angle to allow any free water to shed.
- Make cuts flush to the main branch and as clean as possible with the cutting blade against the main branch.
- Do not leave stubs for wood-boring insects or disease organisms to enter.
- Use a pruning compound only where fireblight or other bacterial infections are present.

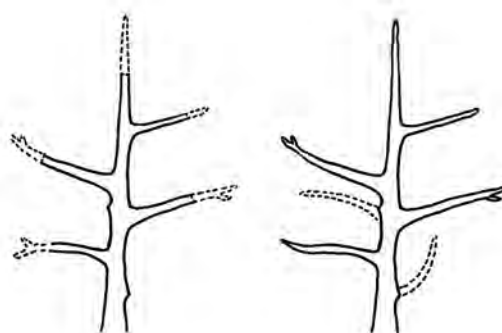

Figure 28. Removal cuts – on left: heading back cuts; on right: thinning cuts.

When removing a large branch (too big for regular secateurs), cut the branch back to a live branch or to a trunk. To remove a large branch, make cuts in three stages:

1. First, make an undercut approximately 15 cm (6 in.) away from the trunk and about one-third of the way into the branch. This undercut prevents the next cut from tearing the bark.
2. Next, make the top cut right through the upper part of the branch about 5 cm (2 in.) beyond the undercut (toward the branch tip). This cut greatly reduces the weight of the branch.
3. What is left is a 15 cm (6 in.) stub that should be removed with a third cut. Because there is little weight on it, the stub is easier to remove, and the bark will not tear.

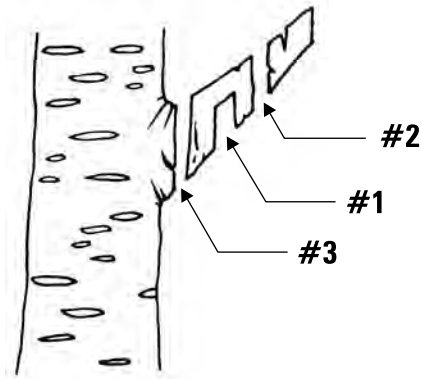

Figure 29. Large branch removal cuts.

Heading cuts

In general, heading cuts remove only part of the growth. When heading back (pruning) a branch, make an angle cut about 5 mm (0.25 in.) above an outward-facing bud. This type of cut allows moisture to roll off the cut surface, deterring the growth of disease.

Heading-back cuts (see Figure 28) are also used to remove the growing point of a branch, which stimulates the growth of side buds and results in more branches. This practice of heading back a growing point on a branch is also known as tipping, which is especially advantageous for a spindly branch or bush.

Severe heading cuts will do the following:

- promote the development of new replacement crown shoots for renewal pruning
- promote feathering of branches on newly planted shrubs
- increase the amount of fruiting wood when training the plants to a bush form

Use a severe (or low) heading cut to force a new shoot from as low on the root crown as possible. The cut is made near the crown if shallow planted and at ground level for deep-planted crowns. Leave a 2.5 to 5 cm (1 - 2 in.) stub on shallow-planted and open-furrow stock, and cut to near ground level for deep-planted stock.



Figure 30. Crown of a shallow-planted mature Saskatoon berry: new buds, which will need to be pruned to maintain the structure, can be seen emerging at the base of the plant. *Photo: Clarence Peters*



Figure 31. This one-year-old, deep-planted Saskatoon berry has been headed, forcing the growth of three main branches now emerging from the crown, which remains beneath the soil. *Photo: Clarence Peters*

After fruiting begins, heading techniques may be used to promote and increase the production of fruiting wood.

Major heading cuts on older, larger or main branches should be made sparingly and angled to existing smaller branches. Do not leave any stubs as they may quickly become infected by several common canker and dieback pathogens.

How much is best?

On the Vermette farm at Yorkton, Saskatchewan, the following aspects of tipping were observed:

No tipping

- few sides branches formed
- branches formed narrow angles
- tall growth observed

Tipping three buds

- moderate branching
- branches formed wider angles
- medium growth observed

Tipping five buds

- best branching
- branches formed wide angles
- shortest growth observed

“Tipping Demonstration” Clarence Peters

Growth habits of Saskatoon berries

Being aware of a few growth traits in Saskatoon berries will help in pruning to greatest effect. Although Saskatoon berry cultivars suppress some of the natural growing and fruiting tendencies found in the wild (native) plants (see Saskatoon Berries in the Wild section near the beginning of this chapter), these cultivars still retain some original growth habits that pruning can modify to the grower’s advantage.

Recognizing these habits may help in better understanding both why the plant requires regular pruning and its response to a pruning program.

Branching habits of Saskatoon berries

Saskatoon berries do not produce new branching well if headed to older wood. The reason for this is due to the differences in the branching and budding tendencies of juvenile plants (years one to three) and those in the reproductive phase.

Indiscriminate heading to older wood should not be practised with Saskatoon berry plants since this procedure effectively removes all or a major portion of the year’s productive wood. Growers need to learn to differentiate between vegetative buds and fruit buds.



Figure 32. Left: juvenile leaf bud – the leaf buds are narrow, pointed and pressed against the branch. The top bud will produce a leader and the side buds, lateral branching. Right: mature mixed fruit bud – fruit buds are fatter and swollen, compared to the buds on the left. The top bud will produce a flower raceme and later, a new leader from a basal bud.

Photos: Clarence Peters

Several years after planting, during the juvenile phase, Saskatoon berries grow only vegetatively, and all the buds (apical/terminal and lateral) produced are leaf buds. Growth extension (in the form of a new leader) occurs from the apical bud, and limited lateral branching and growth extension occur from lateral leaf buds.

Once Saskatoon berries enter the reproductive phase, fruiting begins and all apical and lateral buds have the potential to become mixed-fruit buds (both fruit and vegetative buds) (see the Fruiting Habits section below).

In summary, a plant in the juvenile state produces natural branching while a plant in the mature state produce very little natural branching unless it had a great deal of heading pruning to promote branching.

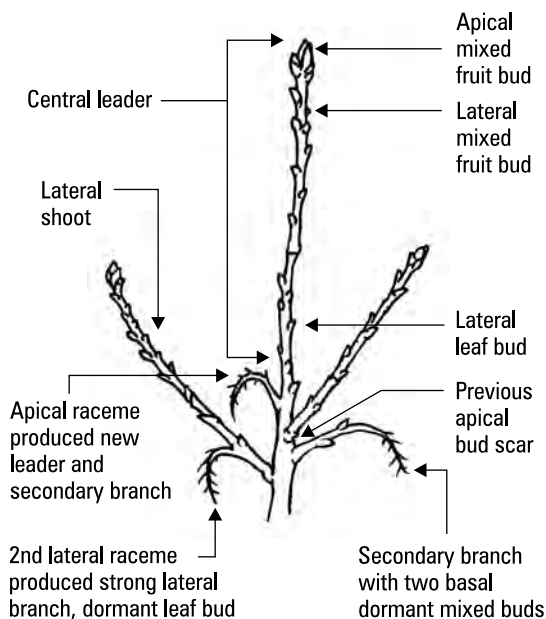

Figure 33. Saskatoon berry biology – typical branching habit. *Diagram: Clarence Peters*

Suckering habits of Saskatoon berries

To some extent, the production of daughter plants through suckering from lateral rhizomes occurs in all Saskatoon berry plants, whether they are seedlings or grown from a clonal or vegetative source. Also, some suckering occurs more readily with certain Saskatoon berry cultivars. (See the Cultivars chapter for information on suckering tendencies in cultivars.)

Contrary to popular belief, annual and moderate pruning reduces the development of suckers. As noted earlier, deep planting has the potential to reduce lateral suckering significantly, since rhizome production occurs from the natural root crown, not readily from the lower stem. This approach means the rhizomes are too deep to be injured by cultivation and less likely to reach the surface.

Fruiting habits of Saskatoon berries

Once Saskatoon berries begin to fruit, they produce mixed-fruit buds – a cluster of fruit buds and several groups of two or three leaves at the base of the fruiting cluster. This growth lasts one year. During the year, the plant prepares for next year's growth by producing a new leaf bud or mixed-fruit buds in the leaf axils on new wood extensions produced on current year's growth.

Only the dominant buds (apical and first laterals) produce a new shoot. However with pruning, additional lateral mixed-fruit buds can be induced to form lateral branches in the same season.

How much to prune and when

The amount of growth that should be removed will depend on what phase of growth the plants are in and the purpose to be achieved. During the early years of a plant's growth, growers will be shaping



Figure 34. Low suckering bush – although under a light skiff of snow, this deep-planted, five-year-old well-pruned Saskatoon berry shows little suckering at the base. *Photo: Clarence Peters*

the plants; later, they will renew the plants annually and develop an ongoing maintenance program. Old plants that have not been pruned regularly may need to have rejuvenation techniques applied.

Dormant season

Pruning during full dormancy is the least disruptive to normal plant functions. All major pruning activities, such as renewal pruning and rejuvenation of hedgerows, should be done during the fully dormant season – late fall, late winter or early spring before any new growth. Late fall will likely be the optimum choice for most growers because of time availability. However, the limited amount of research to date favours spring pruning over fall pruning, but the differences are not great.

A general rule for annual dormant pruning is to remove up to or including one-quarter of the oldest growth. This pruning will include much of the unproductive branches, general thinning and basal cuts to remove a portion of the oldest branches. Specific amounts will be discussed later under each phase of growth.

Bud break

Heading, or tipping, cuts should be made in early spring. Pinching new growth after secondary bud break may be equally effective. The advantage of pinching is that none of the current year's production is lost since the terminal mixed-fruit bud is not removed. Only the vegetative buds at the tip of the branches that expanded after secondary bud break are pinched.

Non-dormant pruning

Pruning after growth has begun in mid to late spring, in summer or even in early fall should be kept to a minimum and only be done to remove diseased or dead tissue. Further research on non-dormant pruning is needed.

Pruning recommendations for Saskatoon berry growth phases

The pruning of Saskatoon berry plants occurs in four phases:

- establishment phase
- training phase
- maintenance phase
- rejuvenation phase

Each phase will be described separately, and a summary table outlining all the pruning recommendations for the growth phases appears after the discussion in the text.

The objectives and procedures for pruning Saskatoon berry plants differ from one growth phase to the next, but as noted, it is important to begin pruning when the orchard is first established.

If growers have taken over some neglected plants or poorly maintained orchard, the following recommendations for rejuvenation will help restore the productivity of the plants.

Plant establishment phase: first or second dormant season

The initial pruning of newly planted Saskatoon berries serves three purposes:

- alters the growth habit of the young plant from a central leader to a multi-stemmed crown
- alters the balance of energy in older transplants by initially building a strong root system
- alleviates a root-bound condition in transplants overgrown in containers

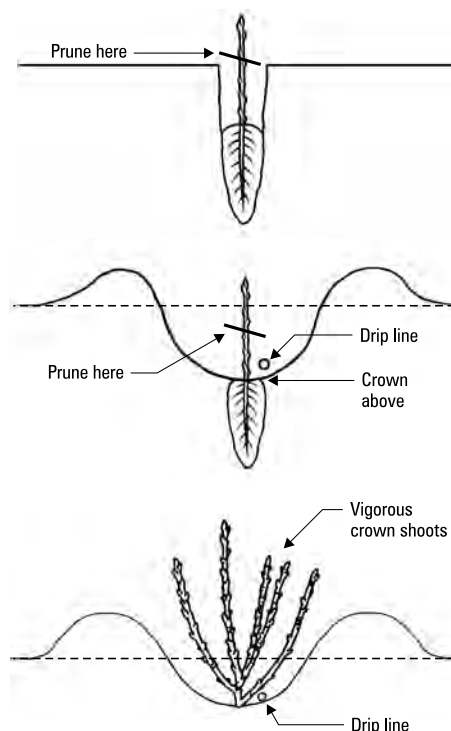

Figure 35. Pruning Saskatoon berry plants: establishment phase. *Diagrams: Clarence Peters*

Initial pruning

Initial pruning develops a multi-stemmed shrub rather than a plant with a strong central leader (especially important with Martin and Thiessen cultivars). Deep planting encourages branching from the crown below the natural ground level rather than from suckers.

The timing of the initial pruning will depend on the type of planting stock (bare-rooted, container grown) and the time of planting.

Whether or not growers deep plant, the crown should be set below the natural ground level to facilitate the development of a low, multi-stemmed crown. If growers do not deep plant, the natural crown should be at least 2.5 to 5 cm (1 - 2 in.) below the soil surface. Deep planting into a trench or open furrow will mean setting the crown from 10 to 15 cm (4 - 6 in.) below the soil surface (see the Planting and Deep Planting sections in the Orchard Establishment chapter).

Initial pruning of bare-rooted plants

Bare-rooted plants, recently dug or with weak root systems, should be transplanted during the dormant season, either in late fall or early spring.

Dormant, bare-rooted plants transplanted in the spring may be pruned immediately after planting if they are strong. Delay the pruning of weaker plants until the following spring.

Delaying pruning may delay bud break, but the delay gives the current root mass a chance to establish. This approach will allow the new vegetative growth required to generate new root growth and develop a balance between top growth and root mass.

Initial pruning of container-grown plants

Plants grown in containers from tissue-cultured plants, etiolated cuttings or seed grown under greenhouse conditions that are properly hardened-off should be transplanted as dormant plants in early spring or late fall.

Fully dormant container-grown plants of sufficient size may be pruned in early spring right after planting. Very small stock plants should be pruned the following spring.

Container-grown plants that are transplanted while actively growing should not be pruned immediately after planting as the procedure would further weaken

the root system. Pruning should be delayed until the first dormant season, ideally the following spring.

Training phase: non-fruiting years

Following the initial pruning during the first dormant period, the plants will have produced numerous new shoots to form the crown. During the second dormant period (about year two), growers now move to training pruning as the plants move from the juvenile phase to the reproductive phase. This transitional period may continue until about year four.

Training pruning is the most important phase in the life of the Saskatoon berry plantation. It will take at least three years to develop a proper bush plant, one with a multi-stemmed crown and a vase-shaped hedgerow, the preferred shape for commercial harvesting. Although growers will be increasing the development of fruiting wood, proper development of the hedgerow at this stage is more important than bringing the plants into production.

The exact procedures for pruning Saskatoon berries have not been well researched, but limited experience and demonstrations suggest the plants appear to respond similarly to well researched pruning procedures for most traditional commercial fruit (currants, gooseberries, high bush blueberries).

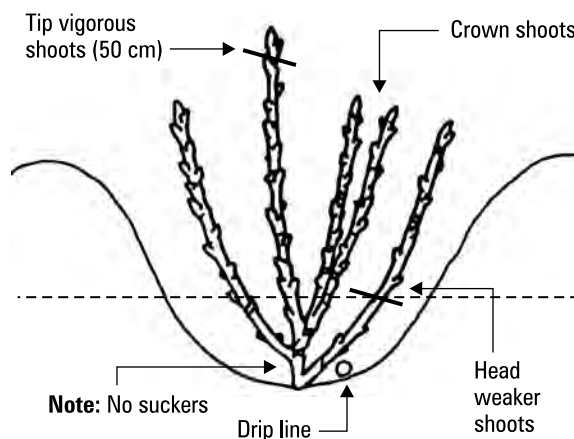

Figure 36. Pruning Saskatoon berries: training phase – Year 2 and Year 3. Diagram: Clarence Peters

Training pruning: pruning techniques

Training pruning removes enough top growth each year to force the plant to produce new shoots from the crown.

Three objectives of training pruning:

- increase the number of basal shoots from the crown
- produce shoots of varying ages to make it easier to begin renewal pruning in later years
- develop a vase-shaped hedgerow

Growers should prune in the late-dormant stage in spring or just after buds start to open. Remember that all, or at least most, of the growth is vegetative in the first few seasons.

Year 1

These procedures force the plant to increase the number of shoots from the root crown.

- select a few upright shoots in the first year
- head them back to knee height if they reach beyond 50 cm (20 in.)
- remove any wide lateral shoots and weaker upright shoots to ground level if shallow planted
- remove any wide lateral shoots and weaker upright shoots to 5 cm (2 in.) from the ground if deep planted

Year 2

- follow the same procedure in the second, third and fourth springs until there are a number of shoots varying in age from one to four-years-old

Years 3 and 4

To force wide-angled lateral branching and increase the annual yield once the plant is fruiting:

- in late spring, just after bud break, head back the oldest shoots to increase the number of lateral shoots (feathering)

At most, this step will delay initial fruiting by one year, but remember that fruiting in the first year is usually insignificant.

Maintenance phase: fruiting/ reproductive years

The pruning during this phase is referred to as renewal pruning, since the objective is to establish a pattern of pruning that renews and maintains the vigour of the plant. The objectives for the pruning procedures during the maintenance or fruiting phase:

- maintain a healthy and vigorous vase-shaped hedgerow as narrow as possible at the base, approximately 30 to 45 cm (12 - 18 in.) by reducing suckering and maintaining a separate root crown
- maintain the hedgerow with a height not exceeding 2 to 2.5 m (7 - 8 ft.) by annually heading leaders back to lateral branches
- maintain a high and predictable annual yield by promoting new growth annually
- replace some of the oldest branches annually through renewal pruning at the base of the root crown

Annual renewal pruning

Renewal pruning replaces growth from the base of the plant over a specified number of years. For example, a four-year renewal system replaces all growth over four years by removing one-quarter of the oldest branches every year. A five-year renewal system replaces all growth in five years and so on.

The key factors to consider in renewal pruning are the branching and fruiting characteristics of the plant:

- how and where it produces its best fruit
- how and where it produces new branches
- the type of hedgerow desired for harvesting

Remember, Saskatoon berries do not usually produce mixed-fruit buds on new shoots in the year they emerge from the crown, but they produce fruit almost exclusively on one-year-old wood thereafter.

Four-year renewal pruning

A four-year renewal system with annual heading of the leaders to promote lateral shoots is recommended. Main shoots older than four years take up considerable space and generally have passed their prime. Older shoots tend to produce less and less as they age and then only on the periphery or outside of the plant. These old shoots just take up space.

Annually removing one quarter of the main shoots forces a sufficient number of new replacement branches without making the crown too dense. Over time, the average of the oldest shoots will be lower, and if the grower has headed them back annually, height growth is controlled when these shoots are removed.

Advantages of a four-year renewal system along with annual heading:

- maintain and extend the longevity of the plantation indefinitely, without the need for radical rejuvenation
- maintain and increase yields substantially
- reduce biennial fluctuations on fewer main shoots from the crown
- reduce and maintain plant stature at an acceptable height
- increase the strength and vigour of lateral branches
- maintain the vigour and health of the plants, since younger wood is less susceptible to some plant diseases (especially canker), wood-boring insects, mechanical injury and breakage

In the spring of the first year of renewal, select a new shoot from the root crown. The shoot is vegetative the first year and produces secondary or lateral branches. The second year, it produces fruit on the main shoot and lateral branches. Each of the following springs, it should be headed annually to continue production of the maximum number of lateral shoots, while also reducing height growth.

By the fifth or sixth year, the branch is usually too high or the base circumference is too large, and it can either be headed back to a lower lateral or removed at the base to force a replacement branch.

Annual tipping or heading

Annual tipping (pruning the dominant bud) and heading during the dormant season (removing a number of apical buds on shoots) encourage lateral branching.

Pinching induces several lateral branches and sacrifices no fruit buds. Tipping sacrifices only a few dominant fruit-producing buds in the current season and produces equally wide-branch angles. The best feathering response can be achieved two ways:

- tipping or heading the leading shoots just after primary bud break
- pinching new leaders that emerge from the secondary bud break

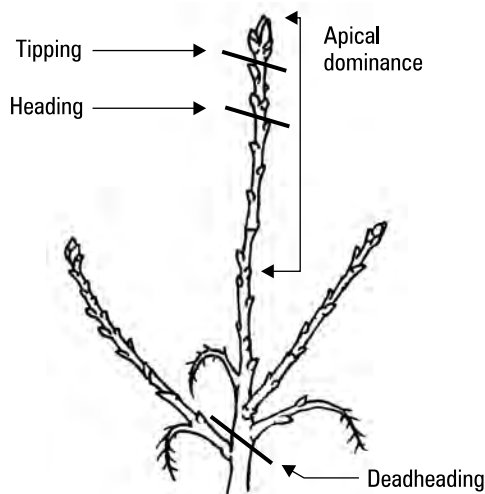

Figure 37. Pruning Saskatoon berries: annual tipping or heading. *Diagram: Clarence Peters.*

Annual and regular maintenance pruning

Besides heading and tipping to encourage new growth, regular maintenance pruning removes mechanically damaged or diseased and insect-infested wood. This pruning may be done at any time as long as it is not excessive.

Remove the following:

- fireblight infections – remove as soon as possible, and pruning tools should be disinfected between cuts
- weak basal shoots, low lateral shoots and branches, unproductive side shoots with few fruit buds and most of the growth up to 50 cm (20 in.)
- lower laterals not producing fruit

The annual thinning of the crown and top growth increases air movement through the plants, which helps reduce plant disease development. This system also lends itself well to various forms of trellising, a system commonly used for many commercial bush fruits in other countries, particularly in Europe. On the prairies, trellises have not been widely used.

Rejuvenation phase of overgrown hedgerows

As noted at the beginning of this chapter, with proper pruning from first planting through the training and maintenance phases, it is possible to maintain a healthy and productive hedgerow at

a proper height and shape indefinitely. However, since many plantations have been allowed to grow to full maturity (some for 8 - 12 years) with little or no proper pruning, other renewal techniques are needed.

Rejuvenating overgrown hedgerows is not easy. Growers will have to contend with a profuse numbers of suckers, roots now so massive that total removal of the top growth stimulates an overwhelming amount of regrowth and the loss of the dwarfing effect.

In addition to regular pruning tools, growers may need chain saws, reciprocating saws, brush cutters, root pruners, pruning saws and a monumental amount of labour.

Recommendations to rejuvenate severely overgrown hedges that have never been properly pruned:

- remove one-quarter of the crown growth annually over four years, and use heading-back cuts to reduce overall height; this method has produced the best results
 - plants tend to compensate for the yield loss by increasing branching and fruiting on the rest of the plant as well as with increased average fruit size
 - regrowth was not juvenile and fruited in the second year

OR

- remove all the growth as close to ground level as possible in the first year (use a variety of methods – brush hog, mower, pruners, etc.), followed by burning the remainder of the crowns with flax straw to produce a narrower hedgerow that produces fewer and stronger new shoots
- when rejuvenating, the rows will have to be narrowed to 25 to 30 cm (10 - 12 in.) by removing all the wide sucker growth as close to the crown as possible, which can be done by mechanical root pruning or by burning the root crowns with flax straw
- apply fertilizer and irrigate (if available) next spring to encourage growth

Keep this in mind...

Fruit will form almost exclusively on mixed-fruit buds produced on one-year-old wood and, to a lesser extent, on mixed buds produced at the base of the previous year's fruiting clusters. All new lateral branches that are induced to grow can potentially produce mixed-fruit buds at each leaf axil along the branch. The new mixed-fruit buds are initiated by July each year, and their development is in direct competition with fruit production, so sufficient nutrients and moisture are very important during this time.

- thin and head new growth the following two seasons, regardless of the method chosen
 - regrowth may be juvenile, resulting in a delayed return to fruiting
- when rejuvenating using this last method, do not apply Casoron (diclobenil) herbicide in the fall before rejuvenation as the chemical affects new shoot development



Figure 38. Total removal at Topps trials: all branches are removed as close to the crown as possible in this row of Saskatoon berries – further pruning of the rapid growth that follows total removal will be needed in year two and three, followed by maintenance pruning. *Photo: Clarence Peters*

Advantages of burning

Burning the remainder of the crowns (after radical rejuvenation) with flax straw can produce a much narrower new hedgerow with fewer and stronger new shoots than a hedge that was only removed to the ground.

Burning has demonstrated a number of other advantages:

- removal of fireblight infections
- killing of all the above-ground portions (stubs) of the plants
- killing of all the shallow-rooted wide suckers
- reduction in the number of new shoots
- emergence of any new shoots from below the soil surface rather than from buds on injured stubs above the ground

Table 5. Pruning recommendations for Saskatoon berry growth phases

Plant Establishment Phase: First or Second Dormant Season

Initial Pruning

Develops a multi-stemmed shrub rather than a plant with a strong central leader.

Bare-rooted plants – spring planted

- strong plants: prune immediately after planting
- weaker plants: delay pruning until the following spring

Container-grown plants

- fully dormant plants of sufficient size: prune in early spring right after planting
- fully dormant small stock plants: prune the following spring
- actively growing plants: prune the following spring

Training Phase

During second dormant period (about year two), move to training pruning as the plants move from the juvenile phase to the reproductive phase.

Year 1

These procedures force the plant to increase the number of shoots from the root crown.

- select a few upright shoots in the first year
- head them back to knee height if they reach beyond 50 cm (20 in.)
- remove any wide lateral shoots and weaker upright shoots to ground level if shallow planted
- remove any wide lateral shoots and weaker upright shoots to 5 cm (2 in.) from the ground if deep planted

Year 2

- follow same procedure in the second, third and fourth springs until there are a number of shoots varying in age from one to four-years-old

Years 3 and 4

To force wide-angled lateral branching and increase the annual yield once the plant is fruiting:

- in late spring, just after bud break, head back the oldest shoots to increase the number of lateral shoots (feathering)

Table 5. Pruning recommendations for Saskatoon berry growth phases

Maintenance Phase: Fruiting/Reproductive Years

Annual Renewal Pruning

The pruning during this phase is referred to as renewal pruning since the objectives are to establish a pattern of pruning that renews and maintains the vigour of the plant.

Renewal pruning replaces growth from the base of the plant over a specified number of years.

- remove some of the shoots at the base during the dormant season

Annual Thinning

- remove non-fruiting, superfluous lateral branches

Annual Heading

- tipping, heading or pinching to promote branching

Annual Maintenance Pruning

- remove damaged shoots
- maintain narrow row by removing wide suckers
- remove low laterals
- control insects and disease by pruning either when dormant or during growing season if needed

Four-year Renewal Pruning

A four-year renewal system with annual heading of the leaders to promote lateral shoots is recommended.

Year 1

- select new shoot from root crown – will be a vegetative shoot; produces secondary or lateral branches

Year 2

- produces fruit on the main shoot and lateral branches

Years 3 - 4 or 5

- head shoot annually each spring to continue production of the maximum number of lateral shoots; also reduces height growth

Year 5 or 6

- branch usually too high or base circumference too large; it can be headed back to a lower lateral or removed at base to force replacement shoot

Annual Tipping or Heading

Annual tipping (pruning dominant bud) and heading during dormant season (removing a number of apical buds on shoots) encourages lateral branching.

- regular maintenance pruning removes mechanically damaged, diseased and insect-infested wood; may be done any time as long as it is not excessive

Remove

- fireblight infections; disinfect tools between cuts
- weak basal shoots, low lateral shoots and branches, unproductive side shoots with few fruit buds and most of the growth up to 50 cm (20 in.) from the ground
- lower laterals not producing fruit

Table 5. Pruning recommendations for Saskatoon berry growth phases

Rejuvenation Phase of Overgrown Hedgerows

Rejuvenation Phase	<p>Rejuvenate severely overgrown hedges that have never been properly pruned:</p> <ul style="list-style-type: none">• remove one-quarter of the crown growth annually over four years; use heading-back cuts to reduce overall height; this method has produced the best results <p><i>or</i></p> <ul style="list-style-type: none">• remove all the growth as close to ground level as possible in the first year; burn the remainder of the crowns with flax straw; do not apply Casoron (diclobenil herbicide) in fall before rejuvenation as this product will affect shoot growth <p><i>and</i></p> <ul style="list-style-type: none">• fertilize and water to encourage growth in the spring• thin and head new growth the following two seasons, regardless of the method chosen
---------------------------	--

Winter Hardiness and Frost Tolerance

Winter hardiness

Although winter temperatures on the prairies can drop to below minus 40°C (minus 40°F), Saskatoon berry plants are extremely hardy and are well adapted to survive, although improperly established seedlings may not.

Growers in Chinook regions, with their cycles of deep cold and thawing, may experience some damage or loss. However, by establishing orchards with optimum conditions and maintaining good cultural practices, growers in Chinook areas can alleviate these risks and establish successful operations (see the Orchard Establishment chapter).

Frost tolerance and injury symptoms

Untimely frosts are another risk for all growers. Frost can damage buds at crucial times in their development, and this damage, in turn, can mean little or no fruit development. If the frost is not prolonged or too severe, the overall consequences may not be too serious. Some buds can survive if they are deeper inside the plant or are facing south and are more advanced in their development than those facing north.

Temperatures of minus 2.2°C (28°F) or lower can damage Saskatoon berry flowers and newly set fruit. If the temperature drops lower, the cold can kill Saskatoon berry flower buds and other growing tissue. Depending on the severity of the frost, damage may be visible an hour later or several days later. Damage is sometimes difficult to see; growers should look for browning inside the flower bud or a slight browning of petals.

The severity of damage to the flower buds depends on their stage of development. Further research on Saskatoon berries and frost is needed, but research on apples, which are in the same family, shows that 30 minutes of the temperatures in Table 6 will kill 90 per cent of the flower buds at each particular stage. The general principle is that as flower buds become more developed and progress towards and past blooming, they become more sensitive to frost.

Table 6. Frost tolerance levels in apples

Flower bud stage	Temperature tolerance
Tight bud flower	–8°C (17.6°F)
First pink	–6°C (21.2°F)
Full pink	–4.6°C (23.7°F)
First bloom	–4°C (24.8°F)
Full bloom	–4.7°C (23.5°F)
Post bloom	–3°C (26.6°F)

Adapted from Mintenko 2007



Figure 39. Frost injury is visible on these Saskatoon berries; it is unlikely they will produce viable fruit.
Photo: Robert Spencer

Diversity

Some strategies can help offset the risks of cold and frost damage. All growers will benefit from establishing their orchards in optimum sites and maintaining good cultural practices.



Figure 40. Diverse orchard – rows of strawberries alternate with a row of raspberries with a row of Saskatoon berries farthest in photo at the Warman Berry Ranch, Saskatchewan. *Photo: Bob Bors*

Growing several different cultivars may help to mitigate risk. Nelson, for example, flowers about one week later than other cultivars, which, in a bad year, might mean the difference between either some harvest or no harvest at all. Even a few days difference in blooming times can make a big difference.

It is often recommended that growers plant two or three cultivars to reduce risk. This practice has the added benefit of also spreading out harvest operations somewhat.

In addition to growing Saskatoon berries, growers should also consider growing other fruit crops such as raspberries, strawberries, chokecherries, black currants, blue honeysuckle or dwarf sour cherries. Slightly varied blooming times for other crops may mean that if one crop fails due to cold conditions, another may not.



Figure 41. Mixed planting – strawberries, raspberries and Saskatoon berries (extreme right) at the Warman Berry Ranch, Saskatchewan.
Photo: Bob Bors

Pests and Diseases

Pest and disease management

As a native of the Canadian prairies, Saskatoon berry plants are host to hundreds of native insects as well as a number of mites and diseases. Fortunately, only a small portion of these elements ever reach pest status.

Pest species are normally kept in check by natural control agents such as predators, parasites and pathogens. Weather patterns most frequently trigger pest outbreaks by interrupting natural cycles. Intervention with broad-based pesticides may also lead to the development of new pest problems by disrupting natural control mechanisms.

A spray chart for control of pests and diseases listed according to bloom and bud stage has been prepared for this chapter and can be found in Appendix 1.11.

Pest management practices

Ways to control pests and diseases:

- *Natural Control Practices*: natural control is a reliance on natural enemies and weather – natural control alone will not be very effective with a native crop such as Saskatoon berries.
- *Cultural Control Practices*: the best cultural practices (site selection, irrigation and fertility management, pruning, orchard sanitation) should be used to maintain a healthy orchard.
- *Mechanical Control Practices*: hand-picking pests, physically removing or destroying infested parts, or installing barriers and traps can be employed in some instances, although these methods are not always effective on a commercial scale. Methods such as pruning can help keep some issues, such as some diseases, in check.
- *Biological Control Practices*: bio-control involves the use of naturally occurring or introduced beneficial organisms such as predators, parasitoids, pathogens or other control agents to suppress and reduce pest populations.

- *Chemical Control Practices*: chemical controls mean the use of manufactured pesticides. The type of pesticide used and the application timing are crucial. When necessary, pesticides should be used with caution in combination with other pest management tools. Overuse of chemicals can lead to the development of resistance in pest populations or the disruption of natural control mechanisms.

Pest management systems

Because of the abundance of wild stands of Saskatoon berries that host a number of important pests and diseases, growers need to be vigilant in monitoring for pest populations. Plantations should be located as far as possible from wild stands where practical. Pest and disease problems may also be cyclical and not a severe problem every year.

Growers should practice integrated pest management and use chemical controls in combination with other pest management practices, rather than relying on chemicals as the sole control method.

Three systems of pest management:

- conventional pest management
- organic pest management
- integrated pest management

Conventional pest management system

A conventional pest management system uses chemical pesticides when pests occur. The system is often effective only in the short term and may disrupt natural control mechanisms. Using this system requires only a basic understanding of the pest or disease.

Organic pest management and production system

An organic pest management system uses natural control methods for pest control, enhancing them if possible. The system uses either naturally occurring pesticides or pesticides accepted for use in organic production.

Integrated pest management system

Integrated Pest Management (IPM) is a term that describes the design and implementation of a pest management program that incorporates a diverse variety of pest control practices for specific pest problems. IPM involves a systematic approach that incorporates natural, cultural, biological and chemical methods of pest control. It requires a detailed understanding of all the pests or diseases.

IPM uses regular scouting or monitoring and requires a greater understanding of pest life cycles to track changes in pest populations over the duration of the growing season. By understanding how a pest population is developing and the actual effect of the pest, growers can make better decisions about management practices. IPM also uses economic thresholds as part of the pest control decision-making process. Management practices are not focused on eradication, but rather on suppression or maintenance of pest populations at levels that do not have an economic effect.

The current level of understanding of the interaction between Saskatoon berries and pests permits the complete use of an IPM system for pest or disease management on Saskatoon berries; however, there is always room for improvement. When available, a diverse set of control options for each pest or disease will be given in this publication so that IPM can be incorporated into orchard practices.

Insect pests

When coping with pests, growers need to be sure they have identified the pest correctly and that they understand its life cycle. Effective treatment depends on choosing the right type of system and/or pesticide.

Timing is everything, since it is the interruption and intervention in the life cycle at the right moment that will destroy eggs, inhibit egg laying or destroy fertile pests. Controls should be applied to attack the most susceptible life stage or to provide protection.

Applying a pesticide after the susceptible stage has occurred or when economic damage has already occurred is a waste of time and money. Some pesticides offer some residual control, but the effectiveness depends on the product.

Pests that feed on buds, flowers and fruit

The pests that have the greatest economic effect on Saskatoon berry plants are those that feed directly on the buds, flowers and fruit, which results in either reduced yield or reduced fruit quality.

Apple curculio, *Anthonomus quadrigibbus* Say (Coleoptera, Curculionidae)

Apple curculio is a *major* pest of Saskatoon berry plants and the most significant of the snout weevil pests of Saskatoon berries. This pest also attacks hawthorn, mountain ash, apples (especially Siberian and ornamental crabs), pear and occasionally, chokecherry. Damage results in a loss of fruit yield and especially a reduction in fruit quality. Since the larvae, pupae and adults may still be inside the berries at harvest time, they are also a fruit contaminant.

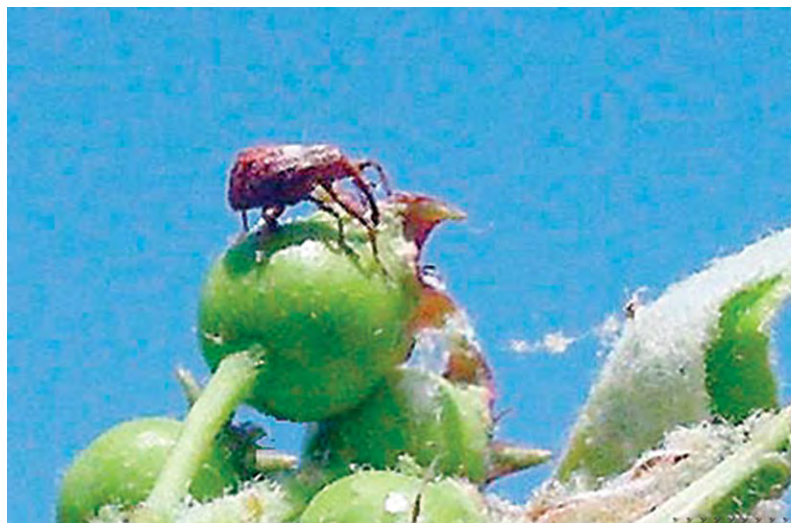

Figure 42. The snout on this adult apple curculio is clearly seen as it prepares to puncture the fruit.
Photo: Clarence Peters



Figure 43. The apple curculio larva has developed and been feeding in the brown area inside the ripening fruit bud. Larvae may also be found inside rotted fruit. *Photo: Clarence Peters*



Figure 44. Damage/holes where the apple curculio has fed are now beginning to rot. *Photo: Clarence Peters*

Life Cycle

- Apple curculio produce only one generation per season.
- The adult stage survives the winter in the soil or plant debris, and adult emergence time is temperature related.
- Adult weevils have prominent snouts, are hard-shelled and bronze to brown with lighter patches and two dorsal humps.
- Weevils become active by mid-May, feeding on flower buds, pollen, flower parts, leaf petioles and later, young fruit.
- Mating occurs soon after they become active.
- Translucent white oblong eggs are deposited inside the fruit through feeding punctures, usually near the stem attachment, and are hidden with frass; one egg is deposited per fruit.
- White to cream-coloured larvae feed on the developing seeds in the fruit.
- Pupation occurs inside the fruit, and pupae may be inside the fruit at harvest time.
- The appearance of the new generation of adults coincides with harvest time, and adult weevils are frequently contaminants in the fruit. New adults seek shelter in debris, where they remain during the rest of summer and over the fall and winter.

Feeding and Damage Symptoms

- Adult weevils initially feed on pollen, but may also injure flowers, stamens and stigmas, as well as stems and new shoots.
- Puncturing of young fruit may cause the fruit to abscise (fall off), and overall yield may be somewhat reduced. Most fruit remains intact, but the quality of the remaining fruit is greatly reduced by the injuries.
- Adult weevils may puncture the fruit, often repeatedly, during feeding and leave deep scars.
- Adult weevils also injure the fruit near the stem attachment during oviposition (egg laying) and larger fruit develop with the larvae inside.

- Larvae feed on the developing seeds in the fruit, and pupae remain in the fruit until they transform into adults.
- Scarred and injured fruit may be misshapen and tight on the stem at harvest.

Controls

Natural

- A number of parasites are common, which keep the pest in check.
- Predators are common, but the weevils are well camouflaged and play dead.

Cultural

- Isolate from native stand of Saskatoon berry and chokecherry.
- Control weeds.
- Remove infested green fruit (time consuming) – not likely cost effective.

Monitoring

- Sweep net sampling is effective; try yellow sticky traps, which have been useful in monitoring in apple orchards.

Chemical

- Application of registered control products should be timed to control arriving adults (balloon stage) or adults present (after petal fall).

Cherry shoot borer, *Argyresthia oreasella* Clemens (Lepidoptera, Yponomeutidae)

Cherry shoot borer is a *major* pest in native stands of Saskatoon berry plants, as well as chokecherry, and is potentially a major pest of Saskatoon berry orchards.



Figure 45. Leaves that stem off this plant shoot are dying due to cherry shoot borer. Photo: Clarence Peters

Life Cycle

- Cherry shoot borers overwinter as eggs on mixed fruit buds.
- Larvae hatch in early spring as the mixed buds begin to expand.
- Larvae feed internally, inside new shoots, in leaf peduncles (stalks) and rachises (central stem) of fruit inflorescences, causing them to wilt and abscise (fall off).
- Mature larvae bore a hole through the base of the inflorescence and drop to the soil to pupate in mid-June.
- Very small, slender, silvery white and gold moths emerge in late June or July, mate and lay eggs in the bracts of new buds.

Feeding and Damage Symptoms

- Initial injury is unseen as the pest burrows into the base of the buds.
- Loss of entire fruit clusters can result.

Controls

Natural

- Several significant parasites are present, which keep the pest in check.

Cultural

- Isolate from native stands of Saskatoon berry, pincherry and chokecherry.

Chemical

- No specific insecticides are registered for this pest in Saskatoon berry plant. Applications of registered control products at early bud stages for control of other pests may provide some control.

Hawthorn lacebug, *Corythuca cydoniae* (Fitch) (Hemiptera, Tingidae)

The hawthorn lacebug can seriously damage Saskatoon berry foliage, and in extreme cases, it may cause complete defoliation of the plants by late summer.

Severe stress may reduce the vigour of the plant and the development of new fruit buds. Alternatively, severe stress may cause the plants to become dormant by mid to late summer, bud and then flower again in late August.

Hawthorn lacebugs are also found on hawthorns, mountain ash and cotoneaster.



Figure 46. Adult hawthorn lacebugs can be found on flowers, fruit and both sides of the leaves. *Photo: Clarence Peters*



Figure 47. Hawthorn lacebug damage - note presence of different stages, as well as frass and debris. *Photo: Robert Spencer*



Figure 48. Hawthorn lacebug damage seen in leaf mottling, caused by the sucking of the cellular sap – note pale sections of the leaves; brown patches indicate dying leaf parts. *Photo: Robert Spencer*

Life Cycle

- Hawthorn lacebugs produce two full generations and a possible partial third generation per year.
- Adults overwinter in leaf litter beneath host plants.
- Adults begin to feed in early spring and mate shortly after.
- Adults are small bugs with a lace-like appearance.

- Black vase-shaped eggs are laid from mid-May to early June on midribs and main veins of leaf undersides.
- Blackish nymphs with few markings hatch in late June to mid-July and are very active.
- Nymphs mature and feed until late August then fall to the ground and find shelter in leaf litter.
- A second generation of adults matures in the fall.

Feeding and Damage Symptoms

- Early spring feeding by wintering adults causes stippling of unfolded leaves and damages developing buds and flowers.
- Adult lacebugs and nymphs suck cellular sap, resulting in greyish spotting, stippling and desiccation of the foliage.
- Later generations feed on all plant surfaces: leaves, stems and developing and maturing fruit, resulting in light ghost spots on the fruit.
- Large populations of adults, with associated sap and frass, can deter some pickers and reduce overall fruit quality.

Controls

Natural

- Ladybird beetles (coccinellid beetles) are a predator; biological control is not practical due to the tendency of beetles to disperse.

Cultural

- Isolate from native Saskatoon berry stands if practical.

Chemical

- No specific insecticide is registered for Hawthorn lacebug on Saskatoon berry plants. Application of registered control products for other registered pests may provide some control of wintering adults and the first generation of nymphs.

Hawthorn weevil, *Pseudanthonomus crataegi* (Walsh) (Coleoptera, Curculionidae)

The hawthorn weevil and other related weevils can also cause economic loss of fruit in Saskatoon berries. The pest generally breeds on native hawthorn.



Figure 49. The hard shell and the snout, which punctures the plant when the hawthorn weevil feeds, are clearly visible. Photo: Clarence Peters



Figure 50. Hawthorn weevil damage: note the punctures on the petals on left and upper right. Photo: Clarence Peters

Life Cycle

- Hawthorn weevils produce one generation per season.
- Adult weevils winter in soil or plant debris and become active in early May, usually by the tight cluster stage.
- Weevils are hard shelled and metallic reddish brown with a long snout.

- Oblong translucent eggs are placed just under the skin of green fruit, although eggs are predominantly laid on hawthorn.
- Weevil larvae are greyish white to cream or light yellow.

Feeding and Damage Symptoms

- Weevils feed on pollen and injure all floral parts, including the anthers, stigmas, petals and green fruit.
- Adults make numerous feeding punctures (often clustered) on green berries; oviposition (egg laying) marks are not distinguishable
- Some research suggests that larvae may tunnel along new shoots, killing flower clusters in a manner similar to cherry shoot borer.
- Infested fruit fails to develop normally, ripens early and unevenly, has hard cores and remains tight on the stem at harvest.

Controls

Chemical

- Application of registered control products should be applied at either balloon floret stage to control some of the overwintering adult weevils as they arrive or shortly after petal fall to control feeding weevils.

Leafrollers, numerous species (Lepidoptera, Tortricidae)

Leafrollers usually feed within folded leaves or within clusters of fruit tied in with the leaves. Numerous species of leafrollers attack Saskatoon berries and many other native and orchard fruit crops, among them:

- fruit tree leafroller, *Archips argyrospila* (Walker)
- oblique-banded leafroller, *Choristoneura rosaceana* (Harr.)
- three-lined leafroller, *Pandemis limitata* (Rob.)
- four-lined leafroller, *Argyrotaenia quadrifasciana* (Fern.).



Figure 51. Oblique-banded leafroller larvae are light green to yellow green to dark green; head is dark brown to black. *Photo: Clarence Peters*



Figure 52. Fruit tree leafroller larvae are light coloured with a dark head; the leaf shows the eating pattern and the beginning of the webbing that will "tie" the leaf, causing it to curl. *Photo: Clarence Peters*

Life Cycle

- Some leafroller species have several generations per season.
- Wintering varies among different species, but leafrollers usually overwinter in the egg stage or as partially developed larvae.
- Larvae begin feeding as leaves begin to unfold and develop.

- Larvae roll, or tie, leaves and feed inside the rolled leaf.
- Pupation occurs within the rolled leaves.
- Adults are moths, generally light tan to dark brown.

Feeding and Damage Symptoms

- Leaves are folded, rolled or tied to fruit clusters.
- Damaged fruits are partially notched or completely eaten.

Controls

Cultural

- Isolation of Saskatoon berry orchards away from native stands or other orchard trees may be of some benefit.

Chemical

- Application of registered oil products at bud break can provide control of fruit tree leafroller.
- Application of registered control products to control other registered pests may provide some control of leafrollers.

McDaniel spider mite, *Tetranychus mcdanieli* McGregor and two-spotted spider mite, *Tetranychus urticae* Koch (Acari, Tetranychidae)

Two species of spider mites can cause economic injury to Saskatoon berries: two-spotted spider mites and McDaniel spider mites.

Two-spotted spider mites are very common and feed predominantly on the undersides of leaves. McDaniel mites are much more damaging and can cause severe injury to fruit buds, flowers, young fruit and leaves when abundant in spring. Mites are not true insects, but are more closely related to spiders.



Figure 53. McDaniel spider mite webbing can be seen, and small dots on the webbing are the spider mites; ladybird beetles are a good predator for control of this pest. *Photo: Clarence Peters*



Figure 54. The extensive webbing clearly indicates that there is an infestation of McDaniel spider mites on this plant. *Photo: Clarence Peters*



Figure 55. Two-spotted spider mite adults - note distinctive dark spots. Photo: Marion Herbut, Alberta Research Council

Life Cycle

- Mature pregnant female mites (bright orange-red) overwinter in the soil, plant debris or under loose bark and become active early in spring.
- Wintering mites lay up to 50 translucent to yellowish round eggs. Fertilized eggs produce females (80 per cent of all eggs), and unfertilized eggs produce males. Mating occurs as the first offspring mature.
- Spider mites go through four developmental stages: a larval stage (six legs), two nymphal stages and an adult stage (eight legs). Under cool spring conditions, a new generation occurs in 15 to 25 days.
- Summer females lay up to 100 eggs each. Eggs are translucent with characteristic spots. Under hot conditions, a new generation occurs in 8 to 15 days
- Spider mites may have 10 or more generations per season.

Feeding and Damage Symptoms

- Spider mites have piercing mouthparts and injure individual cells, causing desiccation and loss of chlorophyll.
- General plant symptoms are speckling and bronzing, beginning on the undersides of leaves

and eventually expanding to all plant parts. A copious amount of webbing is produced, which may enshroud the plants.

- Damage leads to water stress, eventual premature defoliation and blasting of flower buds.
- Two-spotted spider mite feeding may cause plants to have small red or bronze leaves, which may fall off in heavy infestations.

Controls

Natural

- Mites are normally kept in check by a number of predatory mites. Note: chemical applications may also kill these predatory mites, resulting in possible outbreaks of spider mites.

Biological

- Introducing predatory mites may be effective since natural dispersal is very limited.

Cultural

- Isolation from native Saskatoon berry stands, where practical, is recommended.

Chemical

- No specific pesticides are registered for this pest. Applications of registered pesticides for other pests may be effective in controlling spider mites.

Saskatoon bud moth, *Epinotia bicordana* Heinrich (Lepidoptera, Tortricidae)

The Saskatoon bud moth is a native insect and a major pest of Saskatoon berries. It predominantly attacks Saskatoon berry plants but is found on other species of the Rose family: hawthorns, roses, mountain ash, cotoneaster, apples and crabapples (prefers cultivars with densely hairy buds).

The following bud moths also feed on Saskatoon berry buds, flowers and leaves, causing significant damage:

- yellow-headed fireworm (*Acleris minuta*)
- eye-spotted bud moth (*Spilonota ocellana*)
- leafcrumpler (*Acrobasis indiginella*)
- gold-striped leaf-tier (*Machimia tentoriferella*)
- Sparganothis fruitworm (*Sparganothis sulfureana*)



Figure 56. Saskatoon bud moth larva is lodged in the top of the bud, which has been eaten away. *Photo: Clarence Peters*



Figure 58. Saskatoon bud moth damage: webbing-encased debris from the damaged plants may harbour pupae. *Photo: Clarence Peters*



Figure 57. Larva is feeding inside the green fruit cluster. *Photo: Clarence Peters*



Figure 59. Saskatoon bud moth adult is well camouflaged in its natural habitat. *Photo: Clarence Peters*

Life Cycle

- Adult moth is 10 mm (0.4 in.) in length, slate to brownish grey and variously patterned with white, grey and brownish scales.
- Adult moths overwinter under bark and probably in leaf litter.
- Adult moths appear before all snow has melted and may be seen fluttering around Saskatoon berry shrubs on warm calm days, particularly at dusk.
- Adult moths hide under bark on cool days and crawl up and down branches when disturbed.
- Moths mate shortly after emerging in early spring.
- Moths lay cream to light pink to mauve eggs at the base of mixed-fruit buds (bud axils); eggs hatch mid-April to May.
- Larvae are nearly translucent and 1.5 mm (0.03 in.) long with darker heads; they turn light green or cream after feeding.
- Maturing larvae feed on flowers, young fruit and leaves tied together with webbing; most remain in the larval stage throughout the summer.
- Pupation occurs within protective webbing or encased in debris within fruit cluster or leaves.
- New moths emerge very late in fall and immediately seek shelter for the winter.

Feeding and Damage Symptoms

- Newly hatched larvae attack mixed-fruit buds in the silver tip or bud stage, but larvae occasionally feed in the fully dormant bud stage during a very early spring.
- Larvae eat tiny holes, less than 1 mm (0.04 in.) in diameter, through the bracts covering emerging buds, or they slip in behind the bud scales, leaving no visible sign of entry.
- Flower buds with tiny holes may have droplets oozing out.
- Larvae may sever or injure the bud stem and prevent the cluster from expanding, causing them to wilt and dry.
- Flower buds may be yellow and fall off easily when touched.

- Larvae feed on individual flower buds, tying the inflorescence with webbing and removing stamens and stigmas.
- Mature larvae feed on young fruit, tying fruit clusters with webbing.

Controls

Monitoring

- Moths fly at dusk and dawn. They are not attracted to ultraviolet light traps, but pheromone traps could be used.
- Moths are attracted to canary yellow and lemon yellow sticky traps.

Cultural

- Plant away from native Saskatoon berry stands in areas where isolation is practical.

Chemical

- Registered oils can be applied at bud break to control moth eggs and newly emerged larvae.
- Registered control products may be applied at green tip stage to tight bud cluster to control newly emerged larvae. A second application (balloon floret stage) for other pests may provide some control of feeding larvae.

Saskatoon sawfly, *Hoplocampa montanica* Rowher (Hymenoptera, Tenthredinidae)

The Saskatoon sawfly and several closely related sawfly species (*Hoplocampa lacteipennis* Rohwer, *Hoplocampa pallipes* MacGillivry, shadbush sawfly, *Hoplocampa halcyon* Norton) are major pests of Saskatoon berries affecting both yield and fruit quality. When very numerous, these pests can cause a nearly complete loss of fruit. Chokecherry is also a host.



Figure 60. Saskatoon sawfly ovipositing eggs at the base of the flower bud, leaving a scar.
Photo: Clarence Peters



Figure 61. Young Saskatoon sawfly larva will chew holes in the floral cup to feed. *Photo: Clarence Peters*



Figure 62. Saskatoon sawfly injury: black patches are injured fruit that will rot before maturing. *Photo: Clarence Peters*

Life Cycle

- Small, slender wasp-like adult sawflies appear on Saskatoon berry plants just before the balloon stage of the florets. They are darker in the anterior (front end) with a yellowish abdomen.
- Eggs are laid in the nectaries via slits under the calyxes.
- Larvae are cream to yellowish.
- Mature larvae drop to the soil and remain inactive in the soil and debris through the summer, fall and winter.
- Pupation occurs in early spring.

Feeding and Damage Symptoms

- Adult sawflies feed in the nectaries and on the pollen, but cause little or no damage.
- Females make oviposition scars under the calyxes while ovipositing eggs.
- Young larvae chew holes in the floral cup into young fruit.
- Young fruit attacked by larvae abscises (falls off) quickly.

- Larvae partially damage younger fruit and completely hollow out older fruit.
- Damaged fruit may have dark hollow patches; the last fruit attacked is a blackened empty shell.
- Infested fruit may resemble brown rot superficially.
- Each larva destroys several fruits.

Controls

Natural

- Timing of attack sometimes delayed by weather factors.

Cultural

- Isolate from native Saskatoon berry stands where practical.

Chemical

- Registered control products should be applied at 25 per cent bloom to control adults and young, developing larvae.

Tarnished plant bug/Lygus bugs, *Lygus lineolaris* (Palisot) (Hemiptera, Miridae)

Lygus bugs are “true bugs” with piercing/sucking mouthparts. The tarnished plant bug (TPB), the most common species, is a major pest of Saskatoon berries, as well as thousands of other plants, and is extremely abundant every spring. At least five other lygus bugs closely related to the TPB also feed on Saskatoon berries but to a lesser extent.



Figure 63. The image shows the shield shape of the tarnished plant bug adult and gives a good indication of its size. *Photo: Clarence Peters*



Figure 64. The tarnished plant bug has fed on the florets of this plant; petals are missing and partially eaten, and those remaining are limp. *Photo: Clarence Peters*

Life Cycle

- TPBs survive the winter as adults in plant debris and become active very early in spring.
- TPB and related species feed on at least 1,000 other plant species.

- Adult TPBs are variously coloured from greenish to tan, reddish brown or near black; other species are variously coloured and marked.
- All TPBs have the characteristic “shield” shape and long feeding piercing mouthpart (stylet), tucked under the legs; they also have a distinctive yellow triangle on their upper back.
- TPBs rarely lay eggs on the leaves of Saskatoon berry plants, so nymphs (immature insects) are not commonly seen on them. Nymphs resemble aphids but move more quickly.

Feeding and Damage Symptoms

- Adult TPBs are the only life stage usually seen on Saskatoon berries. Adults feed on all bud and flower stages until petal fall and generally move on to other plant species for egg laying.
- Feeding causes blind buds (failure to develop) and bud blast (desiccated buds) that resemble winter injury or partial bud injury resulting in severe stunting or bud curvature.
- Feeding on individual florets causes wilting and blasting of individual florets.
- Feeding causes severe yield reductions.

Controls

Monitoring

- Survey by observation from April 15 to May 15; look for the presence of adult lygus bugs. Look for blind buds (resembles winter injury), buds with droplets of sap oozing out and later, look for wilting, blasted or missing floret buds.

Cultural

- Isolation is impractical because of the wide range and distribution of hosts.

Chemical

- Apply registered control products at green tip stage to control wintering adults. A second application at balloon floret stage may provide some control of adults.

Woolly elm aphid, *Eriosoma americanum* (Riley) and woolly apple aphid, *Eriosoma lanigerum* (Hausm.) (Homoptera, Pemphigidae)

The woolly elm aphid (WEA) and the woolly apple aphid (WAA) are currently among the most destructive insects in Saskatoon berry orchards. The primary host for both insects is the American elm. These insects destroy the root system, and vigilance is particularly needed during the establishment years for new plants.



Figure 65. A serious infestation of woolly apple aphids on elm leaves. *Photo: Clarence Peters*



Figure 66. An example of typical curling of elm leaves caused by a serious infestation of woolly elm aphids (WEA) - note presence of aphids and honeydew inside curled leaves. *Photos: Robert Spencer*



Figure 67. Swollen, spongy root system of a Saskatoon berry plant that has been attacked by woolly elm aphids (WEA). *Photo: Robert Spencer*



Figure 68. Woolly elm aphid infestation causing swollen root system - note white, waxy residue in soil and around the plant. *Photos: Robert Spencer*

Life Cycle

- Life cycles of WEA and WAA are essentially identical.
- Eggs overwinter in bark crevices of American elm trees.
- Wingless mothers hatch in early spring and give birth to two generations of live nymphs.
- A third generation of winged females appears in mid-June to early July and begins to migrate, either by flight or blown by strong winds, to Saskatoon berry plants. This activity takes place around the same time that purple lilacs tend to bloom.
- WEA moves directly to the roots where they produce numerous generations of wingless aphids, and their feeding results in root nodules or galls and the proliferation of extensive fibrous roots in dense clusters.

- WAA initially colonize pruning scars, cankers or the lower portion of main shoots near the ground. Feeding on lower stems causes upright branches to arch horizontally or downward.
- WAA then moves to the main roots, where they produce numerous generations of wingless aphids, and their feeding results in the formation of root nodules or galls.
- In fall (as late as mid-October), winged females return to American elms and give birth to winged males and females, which mate.
- The resulting offspring are all females; each produces a single egg deposited on the bark of the tree.

Feeding and Damage Symptoms

- Initial underground feeding may result in the proliferation of new shoots or densely fibrous root growth, root nodulation and galls.
- First sign of injury is usually in late summer when infested plants turn to fall colours early (flagging) and lose leaves prematurely.
- Feeding also predisposes affected areas to fungal rot organisms in the soil.
- By spring, young plants are severely stunted or nearly dead from fungal root rot.
- Plants may break bud but regress soon after or occasionally grow normally until July and collapse in the intense heat.
- Older, more mature shrubs may be less adversely affected since they are deeply rooted.
- Damage may be confined to new crown shoots or suckers, or damage may be confined to a portion of the plant or a few shoots that die back.

Controls

Monitoring

- Watch for tightly rolled or disfigured leaves on American elms.
- Watch for the appearance of winged aphids in rolled leaves.

- Put out yellow pan traps.
- Check newly planted Saskatoon berries for the presence of winged females from late June to early August.
- Check for evidence of aphid colonization on lateral roots 2.5 to 13 cm (1 - 4 in.) deep and the base of new brown shoots from mid-July to mid-September. Aphids will be coated and surrounded with whitish waxy and woolly material.

Natural

- Watch for ladybird beetles at base of plants and in cracks in soil; they are one of the main predators.

Biological

- Predators include ladybird beetles, syrphid flies and antlions; however, these predators tend to disperse rapidly when released.

Cultural

- Removal of American elms in near vicinity may help, but infestations from elms 160 km (100 miles) away have been recorded.
- No cultivar is immune, but Northline and Smoky are the most susceptible to WEA. Martin and Thiessen are the least susceptible.
- Martin and Thiessen are more susceptible to WAA.
- Plastic and organic mulches do not provide protection; polyethylene fabric mulches proved most effective but also most expensive.
- Row covers from late June to mid-September work, but are cost prohibitive.

Chemical

- Registered systemic control products are available for treatment of established (minimum one year) non-bearing plants as well as for fruiting orchards.
- Treatments are applied as a soil injection or plant drench, with the goal being to saturate the root zone.

- Treatments are ideally applied in early to mid-July, but may be applied as late as early August.
- Timing varies depending on the crop stage (bearing or non-bearing) and the pre-harvest interval of the applied product.

Diseases

As with the insect pest problems associated with Saskatoon berry production, the incidence of diseases in Saskatoon berry orchards is complicated by the presence of wild stands of Saskatoon berry plants. Locating the orchard as far as possible from wild stands and vigilance in monitoring the condition of the plants may help.

Here are Saskatoon berry plant diseases to watch for, their symptoms and also cultural and chemical control methods.

Bacterial blight, *Pseudomonas syringae* (Pseudomonadales, Pseudomonadaceae)

Symptoms and treatment are nearly identical to fireblight (see the Fireblight entry further on in this section).

Blackleaf/witches' broom, *Apiosporina collinsii* (Schwein.) Höhn (Pleosporales, Venturiaceae)



Figure 69. Early stage infection of blackleaf/witches' broom developing on a Saskatoon berry plant - note proliferation of shoots and leaf deformation that is commencing. *Photo: Robert Spencer*



Figure 70. Characteristic "scrolling" symptom of blackleaf on Saskatoon berry - note how leaf margins roll downward. *Photo: Robert Spencer*



Figure 71. Early to heavy development of black felt-like growth on leaf undersides of blackleaf infection on Saskatoon berry. *Photos: Robert Spencer and Manitoba Agriculture, Food and Rural Initiatives.*



Figure 72. The dense clump of deformed branches is typical of blackleaf/witches' broom. *Photo: Robert Spencer*

Blackleaf, or witches' broom, occurs mainly in older or neglected orchards and in wild stands, although it occasionally occurs in small amounts in maintained orchards. Blackleaf is not a lethal disease and should not significantly affect production, provided it is adequately controlled.

Blackleaf overwinters in infected tissues and debris, and spores are produced and released in the spring. The fungus infects the leaves of new shoots and suckers only (older wood is not affected). Infected shoots are stimulated to produce many new shoots (witches' broom). Infected leaves eventually die and may remain on the plant.

Symptoms

- Edges of infected leaves roll downward (scroll-like appearance).
- Undersides of leaves become covered with a grey-brown, felt-like fungal growth, which eventually turns black.
- Infected leaves die and may remain on the branches during winter.

A Pruning Reminder

Pruning can help control disease by removing any diseased portions of the Saskatoon berry plant as soon as growers notice them. Pruning helps control the following:

- bacterial blast
- blackleaf/witches' broom
- cytospora canker
- fireblight

Pruning also improves air circulation, which influences disease development.

Technique:

- cut well below the infection (at least 30 cm or 12 in.)
- disinfect tools immediately after use
- burn refuse

- Shoot tips are stimulated to produce many new shoots (witches' broom symptom).
- Fruit on infected plant parts dries up or ripens prematurely.

Control

Cultural

- Remove and destroy infected seedlings, transplants and branches.
- Prune out infected branches 10 to 20 cm (4 - 8 in.) below infection site.

Chemical

- There are no registered pesticides for the control of blackleaf in Saskatoon berry plants.

Brown fruit rot or mummyberry, *Monilinia amelanchieris* (J.M. Reade) Honey. (Helotiales, Sclerotiniaceae)

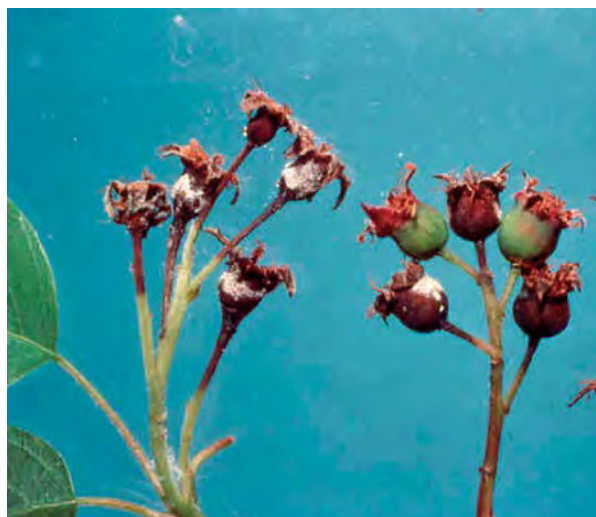

Figure 73. The ripening fruit on these bushes at Davidson, Saskatchewan, show varying stages of brown fruit rot development. The fruit on the left, which has not fully matured, is already mummified. *Photo: Clarence Peters*

Brown fruit rot, or mummyberry, occurs during flowering when spores are released from previous year's fallen mummified fruit and leaves during bud break. The spores can infect flowers, young fruit, and leaves. Disease development is favoured by humid weather.

Symptoms

- Flowers turn brown prematurely.
- Fruit surfaces develop brown spots that progress to light grey-brown tufts.
- Infected fruit may drop or remain on the tree and become mummified.

Control

Cultural

- Collect and destroy mummified fruit and fallen leaves.

Chemical

- Some control of brown fruit rot, or mummyberry, may be achieved by fungicide applications for control of *Entomosporium* leaf and berry spot.

Cytospora canker and dieback, *Cytospora leucostoma* (Pers.) Sacc. (Diaporthales, Valsaceae)



Figure 74. This orchard is weakened and in decline and has a number of bushes succumbing to a cytospora canker. *Photo: Robert Spencer*



Figure 75. Black stain on some of the branches indicates cytospora is spreading internally. Photo: Robert Spencer



Figure 76. The peeling and split bark is another indication of cytospora. Photo: Robert Spencer

Cytospora canker is caused by the organism *Cytospora leucostoma*. Pathogens invade injured areas and progress downwards. Large branches or main stems die back towards the crown of the plant. Infection may spread into root suckers from the crown. Twigs and smaller side branches are more capable of sealing off infection.

This disease is often more prevalent in older, neglected, stressed, weakened or damaged/injured orchards.

Symptoms

- Buds and leaves shrivel in spring.
- Development of fall colours during the season of active growth (flagging).

- Younger bark becomes slightly sunken then wrinkled.
- Older bark splits vertically and peels back revealing reddish inner bark.
- Irregular vertical cracks result in cankers.
- A cone radiating out from the pith causes a black stain indicating the disease is spreading internally.

Control

Cultural

- Prune dying and dead stems 30 cm (12 in.) below observed infection.
- If there is an internal black stain, prune below that.
- Sterilize pruning tools between cuts.
- Burn all pruned material.
- Allow plants to harden off properly in the fall.
- Maintain healthy plants through supply of adequate water, nutrients, etc.

Entomosporium leaf and berry spot, *Entomosporium mespili* (DC.) Sacc. (Helotiales, Dermateaceae)



Figure 77. Entomosporium leaf and berry spot: foliar lesions, angular, blocky lesions. Photo: Robert Spencer



Figure 78. *Entomosporium* leaf and berry spot range of foliar infection levels, from light to severe infections. Photos: Robert Spencer



Figure 79. These berries are infected with *Entomosporium* - note the characteristic spots with a slight halo; berries will be tough and woody textured as a result of infection. Photo: Robert Spencer

Entomosporium leaf and berry spot is the most widespread and serious disease problem that Saskatoon berry producers face every year. This disease is a problem across the prairies, due in part to the high level of incidence within wild stands of Saskatoon berry plants and the difficulty in completely removing this pathogen once it is established in an orchard.

Other plants within the Rose family (including hawthorn, mountain ash, apple and pear) may be infected by *Entomosporium*; however, it is not known how common this disease is a pest of these other hosts.

Entomosporium leaf and berry spot, caused by the fungus *Entomosporium mespili*, infects the leaves, shoots/branches and fruit of the Saskatoon berry plant, rendering the infected fruit unmarketable and reducing the productivity of infected plants through foliar infections and defoliation (in the case of severe infections).

Entomosporium is mainly spread on and within the plant by distinctive-looking asexual spores called conidia. Disease development and spore production are favoured by conditions of high humidity and/or precipitation, warm temperatures and shading. *Entomosporium* develops most rapidly at 20 to 26°C (68° - 79°F) and is most active from early May through mid-July (particularly in wet years).

Spore dispersal is triggered by precipitation and is linked to the movement of water (splash, etc.). In hot, dry years and in drier locations, the incidence and severity of *Entomosporium* may be reduced somewhat.

Conidia of *Entomosporium* infect the leaves of new shoots as well as berries (immature to mature).

There is some debate as to how *Entomosporium* overwinters within a Saskatoon berry orchard. It has been suggested that the pathogen may overwinter on fallen leaves and twigs or perhaps on stems, twigs and branches.

Regardless of how the disease overwinters, once *Entomosporium* is present, growers can assume it will persist and will need to be dealt with on a yearly basis. It is safer to assume that *Entomosporium* is present from the establishment of an orchard and act accordingly.

Symptoms

Leaf Symptoms

- Initial infection appears as small, angular brown spots.
- Spots grow, may join together and are often surrounded by a yellow halo (yellowing increases with increased infections).
- Leaves may turn completely yellow and may fall off if the petioles are infected.

Berry Symptoms

- Lesions on the fruit are watery and greyish.
- Fruit may become discoloured, disfigured, shriveled or cracked.
- Fruit stalks may also become infected.
- Fruit infection greater than 6 per cent can result in rejection by processors.

Control

Cultural

- Ensure adequate air circulation in several ways:
 - prune regularly
 - control weeds
 - correctly orient plant rows in the orchard

- carefully consider plant density
- place shelterbelts carefully to allow sufficient airflow
- Irrigate the soil at the base of the plants, rather than the plants themselves, using drip irrigation systems – do not irrigate with sprinklers.
- Removing fallen leaves may remove some of the disease inoculum; however, this practice will not prevent disease infection and development.

Chemical

- A number of registered control or suppression products are available for use.
- There are NO curative products.
- Apply preventative/protective fungicide sprays to protect developing tissues, with a more specific focus on protecting the fruit.
 - The use of other products may be needed to protect developing foliage.
- Applications can be timed based on two methods:
 - Many products are designed to be applied two to three times over the course of the bud, flower and fruit development period, with ties to specific botanic stages.
 - Make applications beginning at white tip stage, repeating at petal fall and green fruit.

OR

- Use a more integrated approach; make applications based on crop staging as well as weather conditions.
- Make first application after the first rain (rain triggers sporulation) that occurs one or more days after the flowers open (not fully open, but rather as the “floral cup” opens).
- By considering the effect of weather (rain/precipitation and temperature), growers can potentially reduce the number of applications required and the associated costs.
- Further applications may be required if disease pressure is high.
 - Rotate to other chemistry.
 - Consider pre-harvest intervals.

- Rotating chemistry can reduce the likelihood of the development of disease resistance,
- Do not apply any product during full flowering as some products may repel pollinators.

Fireblight, *Erwinia amylovora* (Burrill) Winslow (Enterobacteriales, Enterobacteriaceae)



Figure 80. Both photos show typical fireblight symptoms: the leaves are yellowed or dead but still attached to the branches; the tips of the branches have formed the typical shepherd's crook. Photos: Clarence Peters and Robert Spencer



Figure 81. Fireblight in Purdy orchard. Photo: Ken and Sandy Purdy

Fireblight, named because the affected plant part(s) appears to have been scorched by fire, is one of the most destructive diseases of plants in the Rose family. It is caused by a bacterial pathogen.

Spring weather conditions can influence the occurrence of fireblight, particularly if high relative humidity and showers occur throughout May and June. These conditions promote the development and spread of the disease. Vigorous plant growth in spring and high pollinator activity during blossoming further encourage the spread of the disease.

Temperatures between 18°C and 30°C (64°F - 86°F) favour the spread and development of the disease. A range of 24°C to 26°C (75°F - 79°F) is considered to be ideal for fireblight.

Symptoms often appear suddenly. Initial infection occurs on flowers (blossom and twig blight) and then moves to rapidly growing shoots (shoot blight). Secondary infections are spread by rain, wind, insects and birds. Foliage and bark injured by hailstones may become entry ports for fireblight bacteria. The pathogen can also infect fruit (fruit blight). In severe cases, rootstock may become infected via root suckers.

Symptoms

- Infected blossoms and surrounding tissue wilt rapidly and quickly turn from green to yellow, to reddish brown or black.
 - Newly infected areas appear water soaked.
 - Infected shoots and leaves wilt, forming a characteristic “shepherd’s crook,” and eventually turn reddish brown, appearing scorched.
 - Leaves remain attached to the branches throughout the season on infected shoots.
 - Bacterial ooze (viscous, sticky yellowish to amber fluid) may appear at the edge of infected areas under high humidity conditions.
 - Bacterial ooze may, over time, appear black as it becomes further infected with secondary sooty moulds.
 - Infections on larger branches appear as cankers – dark, discoloured, purplish, slightly sunken areas – which form a crack at the junction of the canker and healthy tissue.
 - Basal leaves on the inflorescence wilt and water-soaked areas form on the fruit.
 - Fruit turns brownish.
 - Fruit shrivels but remains intact and mummified on the tree.
- Plan to isolate the orchard from native stands of Saskatoon berries and other susceptible native species.
 - Avoid lush, succulent growth by practicing fertility management.
 - Apply fertilizer in spring to avoid excess new growth late in the growing season.
 - Avoid heavy use of nitrogen and fresh barnyard manure.
 - Avoid overapplication of fertilizers at any one time – use small, split applications if applying fertilizers.
 - Apply pruning recommendations.
 - Avoid pruning practices that promote excessive new growth, which appears to be more susceptible to fireblight in infected orchards.
 - Remove the infected plants or use controlled burning.
 - Remove the infected plants or in severe cases, the whole orchard.
 - Burn native stands of Saskatoon berry plants in the vicinity of the orchard.
 - Burn the crowns of infected plants with an intense straw fire, which controls fireblight in Saskatoon berry orchards.

Control

Cultural

- Plant resistant cultivars.
 - Consider planting Smoky and Northline, which in an infected orchard have appeared less susceptible than Martin and Thiessen (susceptibility of Saskatoon berry cultivars has not been scientifically determined).
- Isolate the plants or orchard.
- Avoid planting other susceptible ornamental and fruit species in the vicinity of the orchard.

Chemical

- No chemical pesticides are registered for the control of fireblight in Saskatoon berries.

Biological

- A number of registered bio-pesticides have been developed to suppress the fireblight pathogen, mainly through competition.
- Products are typically applied during early bloom through to petal fall.
- Apply products according to label directions.
- It is important to remember that bio-control products may not be compatible with other control products (e.g. copper-based products).

Powdery mildew, *Podosphaera clandestina* (Wallr) Lév (Erysiphales, Erysiphaceae)



Figure 82. Powdery mildew is the white powdery substance on the leaves. *Photo: Anthony Mintenko*

Powdery mildew is caused by the organism *Podosphaera clandestina* and can infect both leaves and fruit. Disease development is favoured by warm, dry weather with a temperature range of 15 to 27°C (60 - 82°F) and continued high humidity. The disease spreads rapidly in dense hedgerows with shaded areas and poor air circulation. This disease is inhibited by rainfall.

Symptoms

- Powdery white growth appears on lower leaves of the main plant and sucker leaves.
- Immature leaves appear distorted.
- New shoots appear stunted.

Control

Cultural

- Grow less susceptible cultivars.
- Collect and destroy fallen debris.
- Ensure adequate air flow within the orchard and around plants:
 - prune regularly

- control weeds
- ensure good plant spacing and orchard row orientation

Chemical

- Registered control products can be applied in protective applications from early flower bud stages through to immature fruit stages.

Saskatoon juniper rust, *Gymnosporangium nelsonii* Arthur. (Uredinales, Pucciniaceae)

Saskatoon juniper rust is a fungus caused by *Gymnosporangium nelsonii* and other species. It requires an alternate host to complete its life cycle.

In early spring, brown galls appear on juniper plants. Following a rain, brownish-yellow jelly-like horns (telial horns) erupt from the galls and discharge spores that travel on the wind and infect Saskatoon berry plants. Infected areas on Saskatoon berry plants produce spores that re-infect juniper plants. Disease development is favoured by wet plant surfaces with air temperatures ranging from 10 to 24°C (50 - 75°F).



Figure 83. The yellow spots on the leaves indicate the early stage of juniper rust in Saskatoon berry plants. *Photo: Clarence Peters*



Figure 84. Spiky projections (pycnidia) erupting from the undersides of Saskatoon berry leaves. *Photo: Robert Spencer*



Figure 85. Spiky projections (pycnidia) erupting from Saskatoon berry rendering them unmarketable. *Photo: Robert Spencer*



Figure 86. A severe rust infection on leaf spurs and fruit of Saskatoon berry is apparent by swelling and deformation of tissues and a copious quantity of rust spores. *Photo: Tricia Simon*

Symptoms

Symptoms on Saskatoon Berry Plants

- Raised yellowish spots appear on leaves and fruit.
- Spots become covered with spiny projections later in the season.

Symptoms on Juniper Plants

- Brown woody galls appear on branches.
- Galls form yellow, jelly-like horns.

Control

Cultural

- Do not plant Saskatoon berry plants within 2 km (1.2 mi.) of juniper plants.

Chemical

- Apply registered control products as a protective spray, with timing of the application varying depending on the nature of the product active ingredient and the time to harvest.

Harvest

Harvesting

Harvesting fruit can account for 50 per cent of the labour needed in the orchard each year, so harvest should be planned well ahead of time. The average peak harvest time for Saskatoon berries is often mid to late July, but the season can vary by plus or minus two weeks.

Good record keeping can help growers estimate harvest time. By noting several key factors over a period of years, growers can calculate harvesting estimations more easily as well as develop a sense of how ripening progresses in the orchard.

Factors to note:

- time of bloom
- first sign of ripening
- point of peak harvest
- last possible time of harvest for picking each variety
- ongoing weather conditions

Ripening

With an average ripening time of mid-July, Saskatoon berries are usually harvested during the hottest time of year. At warm temperatures, ripening accelerates quickly, and berries can easily become overripe and more susceptible to invasion by microbes.

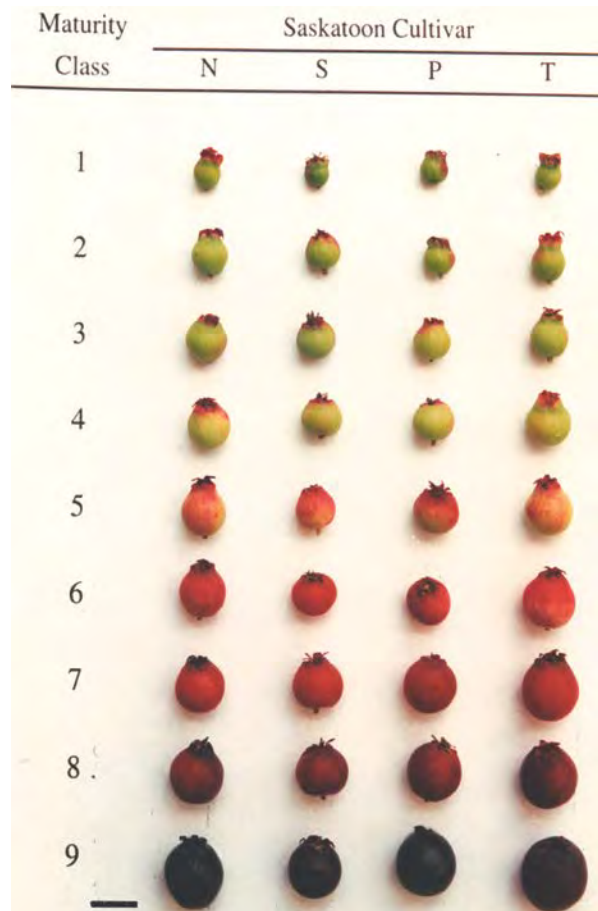

Figure 87. Maturity class index for Saskatoon berry fruit cultivars: Northline (N), Smoky (S), Pembina (P), and Thiessen (T). Fruit in the nine maturity classes were sorted subjectively on the basis of size and colour.

Photo: S.Y. Rogiers and N.R. Knowles, Physical and chemical changes during growth, maturation and ripening of Saskatoon (*Amelanchier alnifolia*) fruit. Can. J. Bot. 75:8:1215-1225. ©Canadian Science Publishing or its licensors.

In a typical year, growers may have a 10 to 14-day window to harvest the fruit. But there will be anomalous years also. Some years, growers may have only a five-day window if it is very hot, or a three-week window if it is unusually cool. In a hot year, there is a greater tendency for even ripening while in a cold year, ripening is spread over a longer time and is more uneven.

Growers should not judge the time of picking by when the berries first turn purple. It usually takes a few more days for the berries to ripen fully. Consider the taste of the fruit and look at the colour of the flesh. Green or white interior flesh indicates the fruit is not ready, but pink or red flesh is optimum. Use the maturity class index (Figure 87) as a guide also.

It is important to understand that half the sugar content of Saskatoon berry fruit is acquired in the last few days of ripening. Saskatoon berry fruit does not continue to ripen after harvest; once fruit is picked, ripening ceases.

Uneven ripening

Regardless of the climatic conditions, uneven ripening is a feature of Saskatoon berries and sorting ripe and unripe fruit will always be necessary.

However, some Saskatoon berry cultivars have a tendency to more even ripening than others. It has been observed that the natural structure of the bushes of a variety plays a role in this tendency. More upright bushes with narrow angles (e.g. Thiessen) are more dense and do not allow light to penetrate into the bush as well as the more spreading types with wider branch angles (e.g. Northline).

Any variety can be improved to encourage more uniform ripening if the plant is properly pruned and thinned. Proper thinning allows for better sunlight penetration. At the same time, proper thinning also leads to better air movement, easier spray coverage and thus, fewer disease problems. Thinning also makes plants easier to harvest by both hand picking and machine harvesting.



Most of these Thiessens are ready for harvest, but some are too ripe and others are not ripe enough.



A harvested flat of unevenly ripened fruit; the unripe fruit will have to be picked out on the sorting line.

Figure 88. Examples of uneven ripening. *Photos: Bob Bors*

Table 7. General ripening tendencies in Saskatoon berries

Cultivar	Ripening Tendencies
Honeywood	fairly even ripening
JB-30	ripen over a period of time; similar to Thiessen
Martin	more uniform ripening within fruit clusters
Nelson	somewhat uneven ripening
Northline	fairly even ripening
Pembina	fairly even ripening
Smoky	relatively uneven ripening
Thiessen	uneven ripening characteristics make it suitable for U-pick orchards

Hand harvesting

Pre-picking

Many operations that pick by hand use ice cream buckets for gathering fruit. Some pickers free both hands for picking by supporting the handle of the pail with a string or rope placed around the neck or by attaching the bucket to their belt.

A more professional alternative (more comfortable and more expensive) is to use picking bags available from orchard supply companies. These bags look similar to newspaper delivery bags, except they go over both shoulders, are waist high and will hold a flat of containers.

When full, the flats are pulled out and sent to the cooler, and a new, empty flat is placed in the bag. If the pickers are instructed to place only the best berries in these containers, then the resulting package is ready to go to the customer.

Because of uneven ripening, it is quite common to send picking crews out every other day or every third day to the same bushes to harvest fruit as it ripens. Often, three pickings are needed.

Keeping track of the information regarding which rows have been picked and when can be solved by making signs with row numbers and giving flags to the pickers to mark the last bush picked. Then, a new picker can easily see where the last picker finished. If the orchard is on a three-day cycle, using three different colours of flags may help keep track of the “when.”

Pick-your-own or U-pick

Pick-your-own or U-pick operations are an option for fruit harvest. Perhaps the key components for the success of these operations are to have a healthy, tasty product, a beautiful, weed-free environment and enough helpful, well-trained and pleasant staff to manage the people. It is also important to have good all-weather parking and clean facilities (washrooms and washing stations).

Allowing customers to pick fruit in the orchard certainly reduces labour costs, but it brings a variety of problems that require creative solutions. The following common problems and solutions table was compiled after discussion with dozens of pick-your-own (PYO) growers.

Table 8. Common problems for Pick-your-own or U-pick operations.

Common Problems	Possible Solutions
The field was muddy from rain, so no one came.	<ul style="list-style-type: none"> • Have grass cover between rows and keep it mowed for easy access.
Customers do not pick enough fruit.	<ul style="list-style-type: none"> • Provide a minimum size, such as an ice cream bucket. • Offer to transport customers to and from the picking areas; customers can tire from walking to the fields or picking in the sun and heat. • Develop a system to take full buckets away for them. Do not forget to put their name on the bucket. • Give away free recipe cards for more ideas on how to use the fruit quickly. • Provide pre-picked fruit (at a higher price) near the cash register just in case customers wanted more but were too tired to continue picking.
The customers (or their children) are eating fruit from the bushes and not putting much in their buckets.	<ul style="list-style-type: none"> • Charge a minimum amount per person who enters the orchard. • Provide an entertaining play area for kids. • Raise your prices.
Customers are breaking branches.	<ul style="list-style-type: none"> • Prune bushes short enough so that fruit is easy to reach.
Picking is sporadic; customers are missing a lot of fruit.	<ul style="list-style-type: none"> • Develop a marker system that directs customers to rows that have fruit that still needs to be picked. • Use staff pickers to go through the orchard at the end of the day and pick missed fruit. • Get into a habit of explaining to customers before they begin that the idea is to go slowly and pick all ripe fruit (reprimands are usually bad public relations); teach customers how to pick properly. • Praise customers who do a good job.
Customers do not know when the season starts and ends.	<ul style="list-style-type: none"> • Design a road sign to indicate “Open” or “Closed.” • Update the operation’s telephone message and website regularly to give out the harvesting information. The telephone number should also be on the road sign, in any advertising and on the website. • Post the information on the operation’s website or a grower group’s website. • Place ads in the local paper. • Encourage/train customers to call before coming to pick. • Send out e-notices indicating the progress of ripening and when the picking season starts and ends.

Pick-your-own (PYO) operations can be springboards for selling other items or starting other complementary businesses. If customers are driving a fair distance to get to the orchard, they may enjoy other activities to make the trip worthwhile.

Restaurants, antique stores, processed products and petting zoos have all been incorporated into successful operations. Greenhouse or bedding plants, mini-golf and corn mazes are also worth considering.

If a grower does not or cannot offer alternatives on his or her own operation, perhaps growers can consider connecting with neighbouring farms and directing customers to each other.



Figure 89. This entrance sign clearly indicates house of operation, crops and other information. *Photo: Robert Spencer*



Figure 90. U-pick sign and row markers. This attractive row marker at the Warman Berry Ranch, near Warman, Saskatchewan, clearly indicates a row of Saskatoon berries and will help direct U-pick customers. *Photo Bob Bors*



Figure 91. A modest but attractive parking lot at Willow View Farms near Arden, Manitoba. Besides selling Saskatoon berries, this operation also sells strawberries, raspberries, chokecherries, and vegetables. *Photo: Bob Bors*



Figure 92. An attractively landscaped area across from the parking lot where children could play or customers could relax. *Photo: Bob Bors*

Having multiple fruit and vegetable crops throughout the season is another great strategy to get customers visiting on a regular basis. In such operations, it is best to let the customer know what new crop is coming next week.

If starting a PYO, it might be a great idea to put the earlier crops in the back of the property and the later ones closer to the entrance; that way, customers will see the new crops coming on. Or perhaps have a few bushes or trees of each crop close to the road for all to see as they drive by.

Mechanical harvesting

As a general rule, mechanized harvesting becomes economically feasible if 40 acres of fruit are to be harvested. Because of uneven ripening, growers who own their own harvesters usually harvest their Saskatoon berry bushes twice with four to six days difference between the early and late harvest dates.

However, if using a harvesting service or renting a harvester, growers may not have the luxury of having the harvester stand idle for a few days, particularly if they are in an area far from other growers. Therefore, growers may want to have only one harvest date. In this case, the yield per acre will be a much lower than multiple-harvest yields because there will be overripe and unripe fruit in the same batch.

Speed of travel, vibration and vacuum strength of the harvester mechanisms are variables that will need monitoring and adjustment throughout the harvest operation, regardless of the type of harvester used. Speed can be faster for bushes with lower yields than bushes with higher yields. Vibration strength may need to be greater for smaller-sized fruit and varieties that tend to hold onto their berries. More vacuum may be needed for large yields.



Figure 93. Joanna sideways harvester - branches lie down and tines knock off berries.

Photo: Robert Spencer

At the start of harvest for any field, the operators need to inspect how well the harvester is performing and make any necessary adjustments. For example, if the harvester picks too many red and green berries, then try reducing the vibration. If ripe fruit is left on the bushes, then try decreasing the tractor

speed or increasing vibration. Several harvester companies have created educational videos to help growers learn how to make these adjustments.

A harvesting machine requires at least three people to operate; many growers prefer five workers or more. One person drives the tractor. One or two workers stand on the harvesting machine placing empty trays to catch the harvested fruit and stacking the trays once they are filled. With additional workers, the filled trays can be unloaded at the end of each row and taken immediately to the refrigerated truck or cooling facility.



One person drives the tractor, one monitors the berries as they fill the flats and one receives and stacks the full flats at Saskatoon Berry Acres, Manitoba.



Harvested fruit travels up the stepped escalator, and the fruit tips into chute and falls into flats. Image also shows the mechanisms (below gauge) for adjusting vibration and speed, etc.

Figure 94. Harvesting crew. *Photos: Bob Bors*

Choosing the right harvester

There are two types of mechanical harvesters: upright (or over-the-row) and sideways. Do not underestimate the importance of the differences between the upright and sideways harvesters.



Over-the-row, pull-type, BEI harvester.
Photo: Lloyd Hausher



Sideways, tractor-towed Joanna harvester at Saskatoon Berry Acres, Manitoba. *Photo: Bob Bors*



Over-the-row, self-propelled, Joonas harvester.
Photo: Robert Spencer



Over-the-row Littau harvester. *Photo: Lloyd Hausher*

Figure 95. Examples of over-the-row and sideways harvesters.

The type of harvester chosen should influence which varieties are grown, how the Saskatoon berry orchard is laid out at planting time and how the bushes are trained. Table 9 summarizes these differences.

Table 9. Differences between upright and sideways harvesters

Plant Variables	Upright Harvester	Sideways Harvester
Plant height	taller: 2 to 2.5 m (6.6 - 8 ft.)	shorter: 1 to 2 m (3.3 - 6.6 ft.)
Plant width	up to 46 cm (18 in.)	up to 1 m (3 ft.)
Training within row	individual plants	solid hedge
Branch number	fewer	more
Branch thickness	can be thicker and older	must be very flexible, therefore thinner and younger
Harvest efficiency	10 to 15 per cent loss in middle of bushes	5 per cent loss, or less
Damage to plants	less damage	more damage
Damage to fruit	more damage	less damage
Row number per acre	more rows, alternating rows can be closer	fewer rows, evenly spaced
Disease pressure	less	more
Annual pruning	more	less
Renew orchard	less often if ever	eventually needed if not pruning annually
Varieties	Thiessen	Northline, Smoky

Upright harvesters

Upright harvesters are better suited for tall plants with narrow rows (a configuration that also has the advantage of increasing air movement and reducing disease). If choosing an upright harvester, growers must prune regularly to reduce suckering and ensure rows remain 46 cm (18 in.) or narrower.

However, since this type of harvester can handle larger bushes, the main branches can be left unpruned for several years. Because fruit is dropped from a greater height, there is a greater possibility of fruit damage.

The upright harvester does not bend branches as much as sideways harvesters do, nor does it have a metal tool to separate the branches, so there is less damage to the bushes. The fish plate catching system is also less efficient than bending the branches to the side, and as a result, the upright cannot catch fruit that falls directly into the centre of the bushes.



Figure 96. Upright, over-the-row harvester from front; the fish plates are the sliding plates on the bottom over opening below tines. *Photo: Robert Spencer*

Because upright harvesters need only be pulled on one side of the row, it is possible to have alternating rows closer together, but this configuration also assumes that growers need less row space for weeding (see Figure 97).

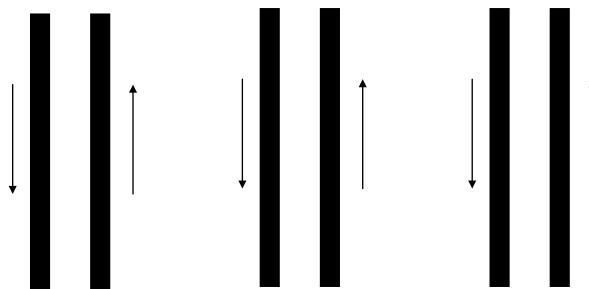

Figure 97. Alternating row widths for upright harvesters: arrows indicate wider spaces are needed between rows for harvesting. Alternate rows could be closer together. *Diagram: Bob Bors*

Sideways harvester

Sideways harvesters are better for shorter varieties of Saskatoon berry plants that have a greater tendency to sucker. Proponents of this harvesting system claim it requires less pruning, and many growers using this harvester do not prune on an annual basis but instead renew the orchard by cutting all the bushes to the ground when the plants grow too large for harvesting.

The thicker density of the bushes creates higher humidity in the orchard and leaves the possibility for more disease since there is likely to be less air movement. However, better coverage with sprays may alleviate the potential for disease problems. One grower reduced the thickness of his shelterbelt to increase air movement in the orchard.



Figure 98. Sideways Joanna harvester enters row; the harvester is beginning a new row at The Saskatoon Farm, Dewinton, Alberta. The plastic mulch is also visible, but the harvester will not damage the mulch if it is properly installed. *Photo: Bob Bors*

Sideways harvesters bend branches away from the centre of the tree. This harvesting method minimizes fruit loss because the branches are held only a few inches from the conveyor belts and shaken, which allows for minimal fruit damage. In recent years, there has been a trend toward sideways harvesters. Sideways machines are generally smaller and tend to be less expensive if purchased new than upright harvesters.



Figure 99. Slight post-harvest damage – these plants are ready for harvest. Although some bending and laying down of branches occurred in a previous harvester pass, the branches can still be harvested. *Photo: Bob Bors*

Ripening and harvesting

Ripening

- fruit usually ripens in July
- fruit ripens more uniformly under even moisture conditions
- evenly ripened fruit can usually be harvested with one or two pickings
- fruit ripens more quickly in hot weather

Mature fruit

- fruit is ready to pick when it is blue or dark purple but not hard
- quality begins to decline once the fruit is fully ripe
- overripe berries have low acidity (pH) as well as high sugar (sucrose) content, and moisture will begin to decline
- mature fruit may burst if moisture or humidity is too high
- mature fruit may shrivel under hot, dry or windy conditions
- fruit will remain on the bush until harvested by humans or birds

Harvesting

- harvest when cool and dry: evening or early morning
- when two-thirds of the fruit are fully ripe and one-third are at reddish purple stage, harvest for fresh fruit market or some processing
- if fruit is semi-ripe, it tends to be more acidic and will have higher levels of vitamin C and pectin, making it suitable for some processing or value-added products

Post-harvest

- place harvested fruit in the shade
- pre-cool within 1 to 2 hours
- prolonged chilling may cause flavour to deteriorate, but delaying cooling may reduce shelf life

Post-harvest

Post-harvest deterioration

The harvesting process generally causes slight damage to the Saskatoon fruit. This damage then allows fungi and bacteria to enter, which causes the fruit to deteriorate. It is amazing how fast fungi can grow under the right conditions: a small brown patch on a berry one day can turn the whole berry into a fuzzy white ball within 24 hours.

Field heat

The post-harvest handling of produce starts even before the actual harvest; the process begins during harvest preparations. Growers start the process by planning the timing of harvest and by having strategies in place to quickly remove field heat from the fruit once it is picked.

Field heat represents the temperature of the fruit at harvest and directly relates to the amount of cooling needed before a crop reaches storage temperature. Removing field heat is the first step in post-harvest handling.

Fruit will deteriorate very rapidly once it is harvested, unless the temperature of the produce can be reduced quickly. Experience and research have shown that harvested fruit should be brought down to a temperature of 0 to 5°C (32 - 41°F) within hours of harvest to maximize the post-harvest life of the produce.

Post-harvest respiration

Fruit undergoes respiration after harvest. During respiration, sugar and starch are broken down to provide ethanol, reducing fruit quality. The sooner the fruit is cooled, the faster the decrease in the rate of respiration and the longer the post-harvest lifespan.

Pre-cool fruit immediately after harvest to decrease respiration rates by lowering fruit temperature to 0°C to minus 5°C (32° - 23°F). Pre-cooling units allow air to flow across the fruit, which is held in ventilated containers.

After pre-cooling, fruit should be covered in plastic to prevent moisture loss.

Store pre-cooled Saskatoon berries at minus 0.6°C to 0°C (31°C - 32°F). Freeze the fruit if it is not intended for the fresh fruit market.

Growth of the fungus *Botrytis cinerea* is inhibited at 0°C (32°F). Its presence can also be reduced through good cultural practices and handling, good sanitation and rapid cooling.

While cool temperatures are critical in ensuring proper storage, this requirement can be reduced somewhat by increasing carbon dioxide (CO₂) levels to displace the oxygen (O₂) required for respiration. Modifying Saskatoon berry storage environments is impractical and probably cost prohibitive for most growers. There is the potential to use modified atmosphere (MA) technology (such as using MA bags) to change O₂ and CO₂ levels in bags, prolonging the post-harvest lifespan in warmer conditions.

Harvest timing to reduce cooling requirements

Planning the timing of harvest can play a significant role in reducing the cooling requirement of harvested fruit and will contribute to prolonging the limited post-harvest lifespan of the crop. The best strategy is to pick the fruit during the cooler times of the day and then cool the fruit as quickly as possible after picking. Berries that are naturally cool at the time of picking are firm and less prone to skin tearing and squashing, making fruit less likely to deteriorate.

For hand picking, the pickers need light, so many growers try to start at sunrise and pick for a few hours or until the temperature is high. Harvesting then stops and resumes later, after the heat of the day has passed, and continues until sunset.

More growers are using mechanical pickers and running them at night, finishing around sunrise. Growers on the prairies have the advantage of nights that tend to have much lower temperatures than daytime temperatures.

Removing field heat

The most common strategy to remove field heat quickly is to have workers whose sole job is to shuttle freshly picked fruit to a waiting refrigerated (reefer) truck or walk-in cooler.

Setting up a wind tunnel also works well. A pallet of fruit in special trays that allow air to pass through them is placed in a tunnel with a large fan at the opposite end that rapidly air cools the fruit. Researchers have found it more effective to pull the air through the tunnel by facing the fan outward at the end rather than trying to push air through by facing the fan into the tunnel.

Most prairie growers use the above “air-cooled” method. In other areas of the world, growers of other, larger crops (notably apples and pears) use water baths to cool and clean the fruit. The harvested fruit is put into large vats of cold water and is then dried before sorting and storing or freezing.

Proper sanitation is critical with the water-cooled method because microbes are easily spread in the water. The water needs to be changed on a regular basis and must be an acceptable quality for fruit processing.



Figure 100. At this Manitoba operation, harvested fruit goes directly into a reefer (refrigerated truck) to be kept cool until the fruit can be cleaned and sorted elsewhere. *Photo: Bob Bors*

Some fruit-sorting assembly lines are equipped with jets that spray water first and then follow with forced air to dry the berries. Some fruit processors have complained that the drying process takes too long or is incomplete and have disabled the washing and drying cycles on the lines.

It may be that the manufacturer of these lines did not take into account the volume of fruit that normally passes through them or the designers did not realize that most processors put their lines in refrigerated rooms where evaporation is much slower than at warmer temperatures.

The sorting line

A sorting line ensures a high quality fruit product. Most harvesting machines blow off most of the stems, leaves and other debris, but only a sorting line will be able to sort unripe and overripe berries. The sorting line will also separate out debris similar in size and weight to the berries, such as dried berries from the previous year or fat caterpillars, both of which have a tendency to stay mixed with the harvested fruit.

Sorting lines usually have two conveyor belts. The first belt feeds the harvest through an air blast cleaner that blows off any remaining dirt and debris. At this point, some growers install a size sorter that automatically removes many of the small unripe or dried berries (it saves time to have this work mechanized rather than have workers manually sort for size).



Figure 101. Workers sort berries on the sorting line.
Photo: Lloyd Hausher

The second belt takes the fruit to the sorting area where workers inspect the fruit and remove anything undesirable. Although rare and expensive, an electric eye can be used for sorting, further reducing the amount of labour used at this step. In most cases, the sorted fruit is immediately put into a freezer. If the berries are to be sold fresh, they are immediately packaged and refrigerated.

Ideally, the sorting operation is in a cool room for several reasons: to keep fruit fresh before and during sorting, to extend shelf life and to reduce fruit rots. While smaller operations may provide a cool, air-conditioned room, larger operations usually have a sorting room similar in temperature to a refrigerator. In addition to adhering to specific requirements for processors and food safety regulations, operators must also ensure that workers are dressed appropriately for working in cool to cold conditions.

The sorting line can be a bottleneck in many operations. Some growers keep the sorting line running 16 hours a day. Other growers try to avoid this situation by setting up very long lines and employing many people on one line.

Still others choose not to have a sorting line and instead sell all the fruit to a processor who does the sorting. In this situation, processors usually pay for the amount of good fruit only and not the discards. Sometimes, this practice has meant that whole truckloads of fruit have been shipped long distances only to discover that most of the fruit was worthless.

There is a point where too much poor quality fruit in a batch makes it not worth sorting. Although there is no precise figure established for Saskatoon berries, processors of other types of fruit on the west coast report that it is not worth sorting a crop with 10 per cent damage. Damage at this level means it may be best to use the fruit for juice or as feed for animals.

Post-harvest study

The use of modified atmosphere (MA) bags in low temperature storage is a recognized method for extending the shelf life of fresh horticultural commodities.

MA bags are made of a plastic that allows the creation of a modified environment within the bag: one that is high in carbon dioxide and low in oxygen concentration.

A three-year study by researchers Zatylny, St-Pierre and Agblor on four Saskatoon berry cultivars – Honeywood, Pembina, Smoky, and Thiessen – was done to determine the effect on fruit quality and shelf life extension of storing fresh Saskatoon berry fruit in MA bags.

The study showed that storage in MA bags efficiently suppressed microbial growth, reduced fruit respiration and allowed fruit to be stored in MA bags at 0°C to 5°C (32°F - 41°F) for up to two weeks with no significant deterioration in fruit quality.

Study results by Agblor and St-Pierre in 2000 also showed that small MA bags were more effective at suppressing microbial growth and maintaining fruit quality during storage than large MA bags.

Processing

Primary processing takes the farm product and puts it into a form that can be stored, transported and readily used to produce value-added products. Secondary processing represents further value-added processing, such as canning, jams, jellies, pies, syrups, etc.

Fresh product

Once Saskatoon berries are harvested, they must be cooled or quick frozen. Fresh, undamaged Saskatoon berries have a limited storage life. There are no good long-term storage methods for fresh Saskatoon berries.

If Saskatoon berries are to be sold fresh, they need to be kept as cool as possible (0 - 5°C or 32 - 41°F), with high humidity (90 - 95 per cent) and good ventilation. Produce should be sold within a few days. The berries lose their taste quickly once they are picked.

Theoretically, it should be possible to ship Saskatoon berries fresh into distribution networks, but at this time, the industry has not developed to that point. At the moment only local markets such as farmers' markets or U-pick operations can provide fresh fruit.

Freezing

At present, most Saskatoon berries are frozen and shipped to various markets. The majority of Saskatoon berries are bulk frozen in boxes lined with food grade plastics. For some markets, one disadvantage to bulk frozen berries is that the berries usually stick to one another, and customers must thaw and use an entire box of berries all at once.



Figure 102. A Saskatoon farm shipping container for Saskatoon berries, which also includes other marketing information. *Photo: Bob Bors*

Berries can also be individually quick frozen (IQF) or flash frozen by setting up an additional step on the post-harvest line. The conveyor belt carries the individual berries into a freezer where they are subjected to forced cold air. By the time fruit reaches the end of the line, each berry is frozen.

This method is more expensive than bulk box freezing, but some markets prefer individually frozen berries that can be poured to whatever quantity is needed for products, where it is important to have individual berries rather than a mash of fruit.

Value-added products

While producing fruit for sale can generate some cash, further processing of the fruit as an ingredient to create other products can greatly add value to the crop. Saskatoon berries can be used to make pies, tarts, jams or as an ingredient in fruit drinks, vinegars, wine, vinaigrettes or chutney. These products may be sold fresh, frozen or in containers.



Saskatoon berry bannock.



Saskatoon berry muffins



The classic – Saskatoon berry pie.

Figure 103. Saskatoon berry baked goods. Photos: Bob Bors

Recognizing the great need for boosting rural income and revitalizing rural communities, several governments have created programs in recent years to encourage entrepreneurs to produce value-added products. Growers can contact their provincial agriculture department or local food processor association to determine what programs are in place. There may be grants, loans, advice or learning centres available.

Food development centres

Saskatchewan, Manitoba, and Alberta all have food development centres that can assist anyone interested in food processing. These centres cover most areas of food processing – from product formulation to testing, business, product and recipe development. The facilities and equipment are available for processing, and food science specialists are available for assistance. Centres may rent equipment and space for manufacturing products. For more information on available services, growers can contact the appropriate provincial centre (see Appendix 1.7.1).

The following training, seminars and assistance may be offered by individual provincial food development centres:

- Good Manufacturing Practices (GMP), with a focus on product quality
- Hazard Analysis Critical Control Point (HACCP) systems, with a focus on producing a safe food product
- ISO 9000 Systems, with a focus on the process of quality assurance
- food microbiology
- Processing Food Safely (PFS), a training course designed to assist small and medium-size food processors with the safety and quality of food products
- food product label design
- food packaging
- plant design, regulations and sanitation
- product formulation and testing

On-farm food safety

Because growers are dealing with food and, possibly, processed food products, they need to be familiar with a number of concerns, guidelines and regulations. Some of these guidelines apply to fruit growing in general while others are more applicable to processors.

Ensuring harvested fruit is free of microbial contamination requires good agricultural and management skills *voluntarily* practiced by the producer. The following guidelines contain basic information about food safety contained in the publication *CanadaGAP On-farm Food Safety Guidelines for Fresh Fruit and Vegetables* (compiled by the Canadian Horticultural Council, Agriculture and Agri-Food Canada, the Canadian Food Inspection Agency and the Canadian Produce Marketing Association).

- Evaluate the production site for existing contamination and the potential for future contamination.
- Design and construct a facility of non-toxic material with adequate hygiene amenities for workers.
- Obtain and check documentation from the chemical and organic fertilizer supplier.
- Become familiar with provincial regulations pertaining to manure application.
- Mulch with non-contaminated material.
- Use appropriate herbicides, insecticides and fungicides for the crop.
- Test the quality of production water used for irrigation and equipment cleaning.
- Use potable water (drinking water) for post-harvest operations.
- Provide a training program for workers to teach sanitary working practices.
- Clean, sanitize and inspect all equipment on a regular basis.
- Develop a pest prevention program.
- Cull damaged produce, and cool harvested fruits and vegetables properly.

These recommendations are general safety guidelines for the handling of all food products and were developed to be used in conjunction with an extensive record-keeping system.

The complete manual of guidelines is available to those who enroll in an On-farm Food Safety Program seminar conducted by a qualified instructor. Although there is a cost for the seminar, growers should take it if they are considering producing value-added products. More information about the program and manual can be obtained from the Canadian Horticultural Council (see Appendix 1.8).

Marketing

Markets

Growers have a variety of choices for marketing their fruit. The approach each grower takes will depend on the size of the operation and the extent to which he or she wishes to be involved in the sale of the produce.

Many growers, however, may choose to try several markets and, for example, use a wholesaler for most of their sales and a local restaurant and a U-pick operation for the balance of the produce. The amount of labour available to assist in the more direct marketing approaches (farm gate sales, farmers' markets) will also influence these decisions.

U-pick or Pick-your-own

U-pick or pick-your-own (PYO) operations are among the most common ways to sell fruit products and can be efficient, relatively inexpensive to run and popular and familiar with the public. They are particularly well suited for operations that are located near population centres on routes that can be reached conveniently.

Requirements

- direct access from a major road with good access to the operation, preferably within 50 km (30 mi.) of an urban centre
- attractive signs placed on busy access roads near the U-pick site that give clear directions to the site
- competitive prices and high quality fruit
- check-in and check-out stand
- personnel to direct customers to the designated harvesting areas
- labour to harvest excess fruit not harvested by customers
- attractive facilities with adequate parking, restroom facilities, water and a picnic area



Figure 104. U-pick containers provided by The Saskatoon Farm, Dewinton, Alberta. *Photo: Bob Bors*

Advantages

- little or no harvesting required (provided customers are thorough)
- no harvesting equipment, transportation or storage costs
- no middleman – immediate cash payment for the product

Disadvantages

- advertising costs
- consumer complaints
- dealing with the public
- customers may skip harvesting hard-to-reach places, damage bushes or eat the fruit in the field

Farmers' markets

Many large urban centres and small communities have established farmers' markets. These markets have been well patronized by the public who appreciate the fresh quality of the produce, the chance to talk to the producers and the ambiance of the market as a gathering place.

For growers with easy access to a farmers' market, costs are relatively low. Growers can contact their provincial government resources to find a list of farmers' markets in their province and the rules and regulations that relate to marketing through these venues.

Requirements

- freshly harvested quality fruit (quality often sells better than low prices)
- competitive prices
- packaging supplies

Advantages

- low overhead costs
- group advertising

Disadvantages

- transportation and handling costs
- a quantity of fruit must be harvested just before going to the market, instead of harvesting on a regular basis or when the fruit is at its optimum
- another market for fruit harvested between market days may need to be found
- may need additional products to justify the cost of maintaining space

Farm gate sales

Farm gate sales also offer the potential for the efficient sale of fruit and allow growers to retain control of their sales. During the harvest season, this method of marketing is demanding in terms of staffing the roadside booth and the fact that some marketing funds will be needed. But successful farm gate operations have shown that the returns on investment are high.

Requirements

- freshly harvested, quality fruit (quality often sells better than low prices)
- well-situated roadside structure – for a smaller operation, a building about the size of a garden shed
- easy access, with room for a roadside structure and parking, preferably close to the field
- clean site with no debris in the area

- attendant seven days a week
- location important: need to be on busy roadway or have many offerings

Advantages

- grower sets price and quality standards – complete control
- no middleman
- greater returns if selling at retail prices (provided enough is sold)

Disadvantages

- labour intensive
- advertising costs
- harvesting and handling costs
- regular supply of product required

Wholesale

Selling through a wholesaler may be an option (or a necessity) for large operations.

Requirements

- require large quantities of fruit packaged in large volumes
- growers must ensure they have a large amount of fruit each year before approaching the wholesalers
- growers must meet a set of quality standards

Advantages

- option for selling large volumes or excess produce

Disadvantages

- less return for the dollar than farmers' markets and farm gate sales
- transportation and handling costs
- potentially some storage costs

Restaurants and hotels

Restaurants and hotels, particularly those that pride themselves on featuring local food products or fine dining, are another potential marketplace for growers. Because of the limited nature of menus and seasonal offerings, this outlet would likely be a supplement to other marketplaces that growers use.

Requirements

- produce must be available when needed on a weekly basis; will likely need to deliver produce to market (not picked up)
- some restaurants and hotels may want frozen produce also
- quality standards and product requirements will vary with each establishment; there is little room for error
- a relationship between the producer and chef will take time and effort to develop

Advantages

- producer sells directly to hotel or restaurant
- some restaurant and hotel outlets may take frozen produce for the off season
- typically good prices

Disadvantages

- produce purchased according to a menu, which may change seasonally
- fresh amounts purchased may be relatively small
- some outlets may not accept frozen produce

Processors

Supplying the harvested berries to a processor who will prepare it for the pre-packaged marketplace (grocery stores, restaurant suppliers) is another choice for mid to large-size growers or those with some harvested fruit at the end of the season that they know will not sell through other outlets.

Requirements

- contracts are often required
- may have to conform to pre-existing standards in the industry – quality may vary depending on the processor
- industry often has preferred varieties
- processors may want the grower to provide large quantities before they will take the grower seriously

An early energy bar

Pemmican is a high-energy food long used by the native peoples of North America. Like all indigenous foods, it used locally available ingredients rendered into what today would be called an energy bar. It was ideal for life on the trail: it was a compact commodity absorbed slowly by the body and provided much needed energy over a long period.

Pemmican was made from dried and pounded meat and rendered meat fat from bison, moose, elk or deer. There is disagreement about the extent to which fruit was added. Certainly, it was sometimes used by the native peoples, but some argue that Europeans, who adopted the use of pemmican, introduced the custom and used fruit as it more suited their palate. When fruit was added, Saskatoon berries were commonly used, although other available native fruit such as cranberries, currants, chokecherries or cherries might have been used.

Advantages

- outlet for harvested fruit that cannot be sold through other outlets

Disadvantages

- shipping costs
- potentially some storage costs
- potentially lower prices than for fruit at wholesale level

Exporting

Saskatoon berries are well known in domestic (prairie) markets, but tend to be generally unknown or novel outside that market. As a result, domestic sales contribute more to the industry than exports do at present.

In the early years of growing Saskatoon berries, many growers limit themselves to selling fresh fruit to local markets, to a processor or to a neighbouring province. But as production increases, growers may begin to think about pursuing markets beyond their immediate regional locales, or they may start to do some value-added processing.

Once a grower reaches this level, he or she will encounter a host of regulations. The type of product being looked at for export will determine the restrictions or regulations that may be in place for exporting.

Becoming an exporter can mean facing a steep learning curve: learning the regulations, processing the paperwork and finding the markets. All these actions must be completed in addition to the work of raising the fruit crop.

The federal government and many provincial governments may provide some support and assistance to growers on becoming an exporter. Various agency websites are the place to begin to get familiar with the process. Appendix 1.9 gives URLs for several websites that address international export.

Health/nutritional benefits

Saskatoon berries, like other dark-skinned berry crops, are considered a very healthy fruit, with high levels of antioxidants and other healthy components that make them a valuable addition to any diet. Numerous studies have found that the Saskatoon berries measure up as equal to or exceeding the potential health benefit of comparable crops.

Producers may use the health and/or nutritional benefits of Saskatoon berries in their promotion and marketing of the products.

Nutrition Facts

Per 100 g	Saskatoon berries
Energy	84.84 calories
Protein	1.33 grams
Carbohydrates	18.49 grams
Total lipid (fat)	0.49 grams
Total fibre	5.93 grams
Vitamin C	3.55 milligrams
Iron	0.96 milligrams
Potassium	162.12 milligrams
Vitamin A	35.68 International Units

Glossary

abscise – to cut off, remove; shed flowers, leaves or fruit following formation of scar tissue

anther – end portion of the stamen where the pollen resides

anthesis – flowering period; opening of a flower

axil – angle formed when small stem joins larger stem

axillary – formed in the axil, for example a vegetative bud lying within the axil formed by leaf stem and stem of branch

basal – base, formation at the base

blind buds – buds that fail to develop

bud blast – desiccated buds

calyx – all the sepals (the outer floral leaf)

conidia – asexual spores of fungi

etiolation – plants grown in the dark for set length of time; they lack chlorophyll (little or no green) and have long fragile shoots

F₁ – first generation of a plant after crossing with two parents

frass – powdery residue left by boring insects; also refers to insect larvae excrement

genotype – genetic make up of a plant

inflorescence – the flowering part of a plant or arrangement of flowers on a stalk; that which blooms into flowers, more than a single flower

in vitro – process that takes place outside a living organism in a test tube or a culture dish; literally, in glass

nectary/nectaries – a gland that secretes nectar; they are usually located at the base of flowers pollinated by insects

nymph – immature insect

ovipositor – pointed tubular organ of female insects used to deposit her eggs

panicle – branched inflorescence

phenotype – physical appearance

pome – a fruit with seeds protected by a tough exterior and surrounded by flesh matter, usually the edible part of the fruit; apples are pomes

recombination – the genetic makeup of a plant produced by crossing two parent plants

sepal – outer floral leaf

stamen – male reproductive organ of flower made up of stalk and anther, where the pollen resides

stigma – female reproductive organ of plant where pollen grains germinate

stool bed – a stump or base of a plant from which many shoots emerge and from which propagative materials (cuttings) are collected; typically made up of healthy, disease-free and vigorous material

precocity – the state where an organism is of advanced maturity at an early age

clone/clonal – created through asexual reproduction/vegetative propagation; all organisms within a group originate from single parent and are genetically identical

vegetative propagation – method of increasing plant material from vegetative parts; reproductive process that is asexual and does not involve genetic recombination

shives – bundles of fibres

References

- Davidson, G. Campbell and G. Mazza. 1991. Variability of fruit quality and plant height in populations of berries (*Amelanchier alnifolia* Nutt.). *Fruit Varieties J.* 45(3):162–165.
- Diseases of Saskatoons. 2004 . Alberta Government. Agriculture, Food and Rural Development. (Available online at [http://www1.agric.gov.ab.ca/\\$department/deptdocs.nsf/all/opp9194](http://www1.agric.gov.ab.ca/$department/deptdocs.nsf/all/opp9194); verified 26 February 2013.)
- Fruit bearing shrubs for multi-use shelterbelts and orchards. 2004. Agriculture and Agri-Food Canada. (Available online at <http://www4.agr.gc.ca/AAFC-AAC/display-afficher.do?id=1199744665442&lang=eng>; verified 26 February 2013.)
- Guide to Fruit Production 2007. Manitoba Agriculture, Food and Rural Initiatives. Website: www.gov.mb.ca/agriculture
- Mintenko, Anthony, 2007. Frost damage and protection in strawberry and saskatoon orchards. Manitoba Agriculture, Food and Rural Initiatives. (Available online at <http://www.gov.mb.ca/agriculture/crops/fruit/blz01s02.html>; verified 26 February 2013.)
- Pennsylvania tree fruit production guide. 2012–2013. Penn State College of Agricultural Sciences. (Available online at <http://extension.psu.edu/fruit-production/tfpg>; verified 26 February 2013.)
- Peters, C.C. 2000. Orchard site selection. Saskatchewan Agriculture and Food. Regina, SK.
- Peters, C.C. 2005. Plants – Seedlings versus clonal plants. Saskatchewan Agriculture and Food. Regina, SK.
- Peters, C.C. 2005. Planting, training and pruning [Saskatoons] for commercial production. Saskatchewan Agriculture and Food. Regina, SK.
- Peters, C.C. 2005. Pruning [Saskatoons] for Commercial Production. Saskatchewan Agriculture and Food. Regina, SK.
- Rogiers, S.Y., and N.R. Knowles. 1997. Physical and chemical changes during growth, maturation, and ripening of Saskatoon (*Amelanchier alnifolia*) fruit. *Can. J. Bot.* 75:1215–1225.
- St-Pierre, R.G., Zatylny, A.M. and Tulloch, H.P. 2005. Evaluation of growth and fruit production characteristics of 15 Saskatoon (*Amelanchier alnifolia* Nutt.) cultivars at maturity. *Can. J. Plant Sci.* 85(4): 929–932.
- Steeves, M.W., and T.A. Steeves. 1990. Inflorescence development in *Amelanchier alnifolia*. *Can. J. Bot.* 68:1680–1688.
- Williams, Sara (1994). Commercial Saskatoon Berry Production on the Prairies: A Growers' Guide. 2nd rev. ed. University Extension Press, University of Saskatchewan.
- Weir, B.J. 1995. Development and application of RAPD analysis for intra-and interspecific characterization within the genus *Amelanchier*. PhD thesis, University of Saskatchewan, Saskatoon, SK.

Appendix

1.1 Industry Resources

1.1.1 Provincial Grower Association Contact Information

Alberta

Alberta Farm Fresh Producers Association

Box 20, Site 3, RR1
Okotoks, AB T1S 1A1
Tel: 1-800-661-2642
Website: www.albertafarmfresh.com

Saskatchewan

Saskatchewan Fruit Growers Association

Box 1107
Yorkton, SK S3N 2X3
Tel: 1-877-97-FRUIT (877-973-7848)
Website: www.saskfruit.com

Manitoba

Prairie Fruit Growers Association

Box 2460
Altona, MB R0G 0B0
Tel: 1-204-324-5058
Fax: 1-204-324-5058
Website: www.pfga.com

1.1.2 Provincial Government Contacts

Alberta Agriculture and Rural Development

Alberta Ag-Info Centre

Postal Bag 600
4705-49th Ave
Stettler, AB T0C 2L0
Tel: 310-FARM (3276) (Toll-free AB)
Tel: (403) 742-7901
Fax: (403) 742-7527

Alberta Agriculture General Contacts

E-mail: duke@gov.ab.ca
Website: www.agriculture.alberta.ca

Saskatchewan Ministry of Agriculture Provincial Specialist, Fruit Crops

Crops Branch
Saskatchewan Ministry of Agriculture
Room 125, 3085 Albert Street
Regina, SK S4S 0B1
Tel: 306-787-4666
Fax: 306-787-0428
E-mail: forrest.scharf@gov.sk.ca

Saskatchewan Agriculture Knowledge Centre

45 Thatcher Drive East
Moose Jaw, SK, Canada S6J 1L8
Hours: 8 a.m. to 5 p.m. Monday to Friday
Tel: 1-866-457-2377
Fax: (306) 694-3938
Toll-free fax: 1-800-775-5358
Out-of-province: (306) 694-3727
E-mail: aginfo@gov.sk.ca
Ask Saskatchewan Agriculture form page
www.gov.sk.ca

Manitoba Agriculture, Food and Rural Initiatives Provincial Fruit Crops Specialist

Crops Knowledge Centre
Box 1149
Carman, MB R0G 0J0
Tel: (204) 745-5675
Fax: (204) 745-5690
E-mail: Anthony.Mintenko@gov.mb.ca

1.1.3 Federal Government Resources

Pest Management Regulatory Agency

<http://www.hc-sc.gc.ca/cps-spc/pest/index-eng.php>

Canadian Food Inspection Agency

<http://www.inspection.gc.ca>

1.1.4 Fruit Research Programs (Prairie)

Domestic Fruit Breeding Program

Dr. R. H. (Bob) Bors, Project Leader
Department of Plant Sciences, College of Agriculture
University of Saskatchewan
51 Campus Drive
Saskatoon, SK S7N 5A8
Tel: (306) 966-8583
Fax: (306) 966-5015
E-mail: bob.bors@usask.ca
Website: <http://www.fruit.usask.ca/index.html>

University of Manitoba – Plant Pathology Research

Dr. Fouad Daayf
Dept. of Plant Sciences
222, Agriculture Building
University of Manitoba
Winnipeg, MB R3T 2N2
Tel: (204) 474-6096
Fax: (204) 474-7528
E-mail: daayff@cc.umanitoba.ca
Website: http://www.umanitoba.ca/afs/plant_science/

Food Development Centre – Processing research

Alphonsus Utioh, Manager Product & Process
Development
(See Food Development Centres)

Canada/Manitoba Crop Diversification Centre

Main Site:
P.O. Box 309
Carberry, MB R0K 0H0
Tel: (204) 834-6000
Fax: (204) 834-3777
Portage la Prairie Site – PFGA fruit research orchard

1.1.5 Irrigation

Agri-Environment Services Branch Canada-Saskatchewan Irrigation Diversification Centre

901 McKenzie Street, South
P.O. Box 700
Outlook, SK S0L 2N0
Tel: (306) 867-5400
Fax: (306) 857-9656
E-mail: csidc@agr.gc.ca
Website: <http://www4.agr.gc.ca/AAFC-AAC/display-afficher.do?id=1186153747182>

1.1.6 Shelterbelts

Agri-Environment Services Branch Agroforestry Development Centre (formerly PFRA Shelterbelt Centre)

P.O. Box 940
Indian Head, SK S0G 2K0
Tel: 1-866-766-2284
Fax: (306) 695-2568
Website: <http://www4.agr.gc.ca/AAFC-AAC/display-afficher.do?id=1186517615847>

Agri-Environment Services Branch Locations

(by region)
<http://www4.agr.gc.ca/AAFC-AAC/display-afficher.do?id=1187362338955&lang=eng>

1.2 Water and Soil Resources

1.2.1 Soil / Water Testing Laboratories

ALS Laboratory Group

Alberta

9936-67th Avenue
Edmonton, AB T6E 0P5
Tel: (780) 413-5227
Toll-Free: 1-800-668-9878

Bay 2, 1313-44th Avenue NE
Calgary, AB T2E 6L5
Tel: (403) 291-9897
Toll-Free: 1-800-668-9878

9505-111 Street
Grand Prairie, AB T8V 5W1
Tel: (780) 539-5196
Toll-Free: 1-800-668-9878

Bay 1 - 235 MacDonald Crescent
Fort McMurray, AB T9H 4B5
Tel: (780) 791-1524
Toll-Free: 1-800-668-9878

Saskatchewan

819-58 Street East
Saskatoon, SK S7K 6X5
Tel: (306) 668-8370
Toll-Free: 1-800-668-9878

Manitoba

1329 Niakwa Road East, Unit 12
Winnipeg, MB R2J 3T4
Tel: (204) 255-9720
Toll-Free: 1-800-668-9878

Exova

Alberta

7217 Roper Road
Edmonton, AB T6B 3J4
Toll-Free: 1-888-263-9268
E-mail: sales@exova.com

7407 Twp Rd 485
Drayton Valley, AB T7A 1S8
Toll-Free: 1-888-263-9268
E-mail: exova@exova.com

#5 - 2712-37 Avenue N.E.
Calgary, AB T1Y 5L3
Toll-Free: 1-888-263-9268
E-mail: sales@exova.com

144 Swanson Dr.,
Hinton, AB T7V 1H1
Toll-Free: 1-888-263-9268
E-mail: sales@exova.com

2916-7 Avenue North
Lethbridge, AB T1J 4H1
Toll-Free: 1-888-263-9268
E-mail: sales@exova.com

11301-96 Avenue
Grande Prairie, AB T8V 5M3
Toll-Free: 1-888-263-9268
E-mail: sales@exova.com

Saskatchewan

508-12 Avenue
Estevan, SK S4A 1E6
Toll-Free: 1-888-263-9268
E-mail: sales@exova.com

Agvise Laboratories

P.O. Box 510
Northwood, ND 58267
Tel: (701) 587-6010
Fax: (701) 587-6013
www.agviselabs.com

P.O. Box 187
Benson, MN 56215
Tel: (320) 843-4109
Fax: (320) 843-2074

A & L Canada Laboratories Inc.

2136 JetStream Rd.
London, ON N5V 3P5
Tel: (519) 457-2575
Fax: (519) 457-2664
E-mail: alcanadalabs@alcanada.com

Midwest Laboratories Canada

#8, 4001B - 19th Street N.E.
Calgary, AB T2E 6X8
1-877-245-TEST (8378)
Tel: (403) 250-3317
Fax: (403) 250-5249
E-mail: mwl@midwestlabsCanada.

Western Ag Labs

#3-411 Downey Road
Saskatoon, SK S7N 4L8
Tel: (306) 978-0373
Fax: (306) 978-4140
www.westernaglabs.com

1.2.2 Water Licensing Resources

Alberta

Alberta Environment and Sustainable
Resource Development
Environmental Hotline Tel: 1-800-222-6514 (toll-free)
<http://environment.alberta.ca/02206.html> - Water Act

Saskatchewan

Water Security Agency (Head Office)
400-111 Fairford St. E.
Moose Jaw, SK S6H 7X9
Tel: (306) 694-3900
Fax: (306) 694-3105
E-mail: comm@wsask.ca

Irrigation Branch (Saskatchewan Ministry of Agriculture)
Room 226, 3085 Albert Street
Regina, SK S4S 0B1
Tel: (306) 787-7474
Fax: (306) 787-9623

Manitoba

Manitoba Water Stewardship (Water Licensing Office)
Box 16 - 200 Saulteaux Crescent
Winnipeg, MB R3J 3W3
Tel: 1-800-214-6497 (toll-free)
Tel: (204) 945-3983 (Water Licensing Office)
E-mail: mws@gov.mb.ca

1.3 Licensed Wholesale Propagators

All contact information was current at time of publication.

Alberta

PrairieTech Propagation
5510-55 Ave
Bonnyville, AB T9N 2M9
Tel: 1-866-977-8733 or (780) 826-6654
Fax: (780) 826-4790
E-mail: ptpropagation@telus.net
Website: www.prairietechpropagation.com

The Saskatoon Farm
RR 1
DeWinton, AB T0L 0X0
Tel: 1-800-463-2113 or (403) 938-6243
E-mail: saskfarm@telusplanet.net
Website: www.saskatoonfarm.com

Manitoba

Glenlea Greenhouses
2717 HWY 75
c/o Box 2
Glenlea, MB R0G 0S0
Tel: (204) 882-2626
Fax: (204) 487-7554
E-mail: info@glenleagreenhouses.com
Internet: www.glenleagreenhouses.com

Jeffries Nursery
P.O. Box 402
Portage La Prairie, MB R1N 3B7
Tel: (204) 857-5288
Fax: (204) 877-2877
E-mail : jeffnurs@mts.net
Internet: www.jeffriesnurseries.com

T&T Seeds
Box 1710
Winnipeg, MB R3C 3P6
Tel: (204) 895-9962
Fax: (204) 895-9967
E-mail: garden@ttseeds.com
Website: www.ttseeds.com

Saskatchewan

Prairie Plant Systems Inc.
Box 19A, RR 5
1 Plant Technology Road
Saskatoon, SK S7K 3J8
Tel: (306) 975-1207
Fax: (306) 975-0440
E-mail: pps@prairieplant.com
Internet: www.prairieplant.com

Select Seedling Nursery
Box 1A RR#3
Saskatoon, SK S7K 3J6
Tel: (306) 978-1940; Toll Free: 1-800-806-7577
Fax: (306) 384-1747
E-mail: info@selectseedlingnursery.com
Website: http://www.selectseedlingnursery.com/

Zosel Tree Farm
Box 179
Pleasantdale, SK S0K 3H0
Tel: (306) 874-5729

British Columbia

AgriForest Bio-Technologies Ltd
4290 Wallace Hill Road
Kelowna, BC V1W 4B6
Tel: (250) 764-2224
Fax: (250) 764-2224
E-mail: info@agriforestbiotech.com
Website: http://www.agriforestbiotech.com

Québec

Végétolab Inc.
6502 Ave du Pont Nord
Alma, QC G8E 1X7
Tel: (418) 347 1737
Fax: (418) 347 1737
E-mail: vegetolab@vegetolab.com
Website: www.vegetolab.com/

1.4 Equipment

All contact information was current at time of publication. Please note that this does not represent a comprehensive list, nor an endorsement of any particular product or company.

1.4.1 General Horticultural Suppliers (fertilizer, pesticides, mulch, etc.)

Direct Solutions a division of Agrium Advanced Technologies
www.growercentral.com
Tel: 1-800-661-2991

Professional Gardener Co Ltd
915-23 Ave SE, Calgary, AB T2G 1P1
Tel: (403) 263-4200

Early's Farm and Garden Centre
2615 Lorne Ave
Saskatoon, SK S7J 0S5
Tel: 1-800-667-1159 (toll-free) or (306) 931-1982
Fax: (306) 931-7110
Website: <http://www.earlysgarden.com/>

1.4.2 Picking / Cooling Trays

Thunderbird Plastics
6969 Shirley Avenue
Burnaby, BC V5J 4R4
Tel: (604) 433-5624 or Toll-free: 1-888-77T-BIRD (888-778-2473)
Fax: (604) 433-6231
E-mail: info@thunderbirdplastics.com
Website: <http://www.thunderbirdplastics.com/>

Intercrate Containers Corp
Suite 105 - 657 Marine Drive
West Vancouver, BC V7T 1A4
Tel: (604) 922-4446
Website: www.intercratecontainer.com

Macro Plastics (Corporate)
2250 Huntington Drive
Fairfield, CA, USA 94533-9732
Tel: 1-800-845-6555 (Toll Free within the United States)
Tel: (707) 437-1200
Fax: (707) 437-1201
Website: www.macroplastics.com

1.4.3 Harvesters

BEI Incorporated
1375 Kalamazoo Street
South Haven, MI, USA 49009
Tel: (269) 637-8541; 1-800-364-7425
Fax: (269) 637-4233
E-mail: sales@beiintl.com
Website: <http://www.beiinternational.com/>

Proditel Marketing Corp
North American distributor for

- Joanna berry harvesters
- Victor berry harvesters

E-mail: info@proditel.com
Website: http://www.proditel.com/the_firm_002.htm

Littau Harvester
855 Rogue Avenue
Stayton, OR, USA 97383
Tel: (503) 769-5953; 1-866-262-2495
Fax: (503) 769-4562

6881 East 5th Place
Lynden, WA, USA 98264
Tel: (360) 398-9845
E-mail: info@littauharvester.com
Website: <http://www.littauharvester.com/>

Korvan Division (OXBO International Corp.)
270 Birch Bay Lynden Road
Lynden, WA, USA 98264
Tel: (360) 354-1500
Fax: (360) 354-1300
Website: www.korvan.com

1.4.4 Other Equipment Suppliers

Northern Horticulture Equipment
Box 752
Calmar, AB, Canada T0C 0V0
Tel: (780) 987-3217
Fax: (780) 987-4364

Willsie Equipment Sales Inc.
R.R. # 1
9516 Northville Road
Thedford, ON N0M 2N0
Tel: (800) 561-3025 (toll free Canada or USA)

1.5 Bees

Alberta Beekeepers Commission
#102, 11434-168 Street
Edmonton, AB T5M 3T9
Tel: (780) 489-6949
Fax: (780) 487-8640
E-mail: gertie.adair@AlbertaBeekeepers.org
Website: www.albertabeekeepers.org

Saskatchewan Beekeepers Association (SBA)
Box 55 RR3
Yorkton, SK S3N 2X5
Tel: (306) 783-7046
Fax: (306) 786-6001
Website www.saskbeekeepers.com

Manitoba Beekeepers Association
Website: www.manitobabee.org

1.6 Organics

1.6.1 Provincial Associations

Alberta Organics
9949-79 Ave
Edmonton, AB T6E 1R3
Tel: (780) 271-1116
Website: www.organicalberta.org

Saskatchewan Organic Directorate

PO Box 32066
RPO Victoria Square
Regina, SK S4N 7L2
Tel: (306) 569-1418
Website: www.saskorganic.com

Manitoba Organic Alliance

P.O. Box 310
Plumas, MB R0J 1P0
Tel: (204) 386-2371

1.6.2 Organic Production

Organic Agriculture Centre of Canada

c/o Department of Plant Sciences
University of Saskatchewan
51 Campus Drive
Saskatoon, SK S7N 5A8
Brenda Frick, Prairie Coordinator
Tel: (306) 966-4975
Fax: (306) 966-5015
E-mail: brendafrick@usask.ca
Website: www.organicagcentre.ca

Alberta

[http://www1.agric.gov.ab.ca/\\$department/deptdocs.nsf/all/bdv11369](http://www1.agric.gov.ab.ca/$department/deptdocs.nsf/all/bdv11369)

Saskatchewan

www.agriculture.gov.sk.ca/crops_organics

Manitoba

www.gov.mb.ca/agriculture/organic

1.7 Food Processing

1.7.1 Food Processing / Development Centres

Alberta

Food Processing Development Centre
6309-45 Street
Leduc, AB T9E 7C5
Tel: (780) 986-4793
Fax: (780) 986-5138

Saskatchewan

Food Centre

117-105 North Road
Saskatoon, SK S7N 4L5
Tel: (306) 933-7555
Fax: (306) 933-7208
E-mail: info@foodcentre.sk.ca
Website: www.foodcentre.sk.ca

Manitoba

Food Development Centre

Box 1240
810 Philips Street
Portage la Prairie, MB R1N 3J9
Tel: 1-800-870-1044 (Toll-free)
Tel: (204) 239-3150
Fax: (204) 239-3180
Website: www.gov.mb.ca/agriculture/fdc

1.7.2 Food Processor Associations

Alberta Food Processors Association

Suite 100W 4760-72 Ave SE
Calgary, AB T2C 3Z2
Tel: (403) 201-3657
Fax: (403) 201-2513
E-mail: info@afpa.com
Website: www.afpa.com

Saskatchewan Food Processors Association

Suite 107 - 105 North Road
Saskatoon, SK S7N 4L5
Tel: 1-866-374-7372 (Toll-free)
Tel: (306) 683-2410
Fax: (306) 683-2420
E-Mail: info@SaskMade.ca
Website: www.saskmade.ca/

Manitoba Food Processors Association

Unit 12 - 59 Scurfield Blvd.
Winnipeg, MB T3Y 1V2
Tel: (204) 982-MFPA (6372)
Fax: (204) 632-5143
E-mail: mfpa@mfpa.mb.ca
Website: www.mfpa.mb.ca

1.8 Food Safety

Canadian Horticultural Council

On-farm Food Safety Guidelines for Fresh Fruit and Vegetables

9 Corvus Court
Ottawa, ON K2E 7Z4
Tel: (613) 226-4187
Fax: (613) 226-2984
Website: www.hortcouncil.ca/chcmain.htm

1.9 Marketing Information

1.9.1 Some Exporting Resources

Foreign Affairs and International Trade Canada

TCS Enquiries Service (BCI)
125 Sussex Drive
Ottawa ON K1A 0G2
Tel: 1-888-306-9991
Fax: (613) 996-9709
E-mail: enqserv@international.gc.ca
Website: <http://www.infoexport.gc.ca/ie-en/EmbassyCountryListing.jsp?rid=12>

Agri-Food Trade Service

Agriculture and Agri-Food Canada
Public Information Request Services
Agriculture and Agri-Food Canada
Sir John Carling Building
930 Carling Ave
Ottawa, ON K1A 0C7
Tel: (613) 759-1000
Fax: (613) 759-7977
E-mail: info@agr.gc.ca
Website: <http://www.ats.agr.gc.ca/info/europe-e.htm>

Saskatchewan Trade and Export Partnership (STEP)

Regina Office
P.O. Box 1787
320-1801 Hamilton St.
Regina, SK S4P 3C6
Tel: (306) 787-9210
Fax: (306) 787-6666
E-mail: Go to Contact Us on website
Website: www.sasktrade.sk.ca

Saskatoon Office
500-402 21st Street E.
Saskatoon, SK S7K 0C3
Tel: (306) 933-6551
Fax: (306) 933-6556
E-mail: Go to Contact Us on website
Website: www.sasktrade.sk.ca

1.9.2 Foreign Labour

Hiring Agricultural Foreign Workers in Canada
http://www.rhdcc-hrsdc.gc.ca/eng/workplaceskills/foreign_workers/temp_workers.shtml

1.10. Print and Web Resources

1.10.1 Saskatoon Berry Cost of Production Resources

Costs and Returns for a Saskatoon Berry Orchard

<http://www.agriculture.gov.sk.ca/Default.aspx?DN=6b8ffe92-0a86-45b1-95d9-302c42c726f0>

Economics of Saskatoon Berry Production – A Ten-acre Enterprise

[http://www1.agric.gov.ab.ca/\\$department/deptdocs.nsf/all/econ7053](http://www1.agric.gov.ab.ca/$department/deptdocs.nsf/all/econ7053)

Guidelines for Estimating Saskatoon Berry Production Costs

<http://www.gov.mb.ca/agriculture/financial/farm/pdf/copsaskatoonscosts2008.pdf>

Template Business Plan for Manitoba Saskatoon Berry Producers

<http://www.gov.mb.ca/agriculture/crops/fruit/pdf/bld01s06.pdf>

1.10.2 Business Planning Resources

Business Planning

Developing a business plan, funding programs for small businesses, irrigation opportunities, and farm diversification.

www.agriculture.gov.sk.ca/Business-Planning

1.10.3 Other Production-related guides

Growing Saskatoons – A Manual for Orchardists
(Out of print – available on-line)

Out-of-print comprehensive Saskatoon berry production manual – Dr. Richard St-Pierre

www.prairie-elements.ca/saskatoons.html

Manitoba Fruit-related Guides

Manitoba Fruit Crop Guide 2010 (updated periodically)

Manitoba Fruit Crop Protection Guide (updated biannually)

Manitoba Fruit Crop Insect Guide
<http://www.gov.mb.ca/agriculture/crops/cropproduction/gaa01d15.html>

MAFRI Crops Knowledge Centre

Box 1149
Carman, MB R0G 0J0
Tel: (204) 745-5660

1.11 Saskatoon Berry Bud/Bloom Staging/Pests/Pesticides

Every year, Saskatoon berry producers are faced with the challenge of preventing and managing pests in their orchards. These pests (whether disease or insect pest) occur naturally in wild stands and, at this point, are essentially present in most orchards on the Prairies. Many of these pests can be tough to recognize or locate in an orchard, as they lurk in hard to reach areas. Management can be challenging, as the most sensitive or most effectively controlled stages are only active for short times. Most controls are protective or preventative, rather than curative.

Most chemical controls are recommended to be applied at specific botanical stages of the Saskatoon berry, which coincide with specific points within pest life cycles or are timed to provide a window of protection for sensitive plant parts. These stages are

somewhat generic, but can be used as a guide for effective chemical control application.

The following is a general outline of the different stages of leaf and flower bud development, from bud break through to fruiting, with associated pests and registered chemicals.

It should be noted that the rate of development through these stages can vary, depending on seasonal weather conditions and regional climatic influences, and as such, pictures and information should only be used as a general guide. While specific products may be applied at a number of different stages, pesticide labels should be carefully consulted for appropriate application rates and the number of applications allowed per season. Application costs should also be considered as well as whether the control product is actually required.

In the following table:

- PHI = pre-harvest interval
- REI = re-entry interval

Saskatoon Berry Bud/Bloom Staging/Pests/Pesticides

	Pests controlled	Chemicals registered	Other comments
Dormant Bud Stage			
	Saskatoon Bud Moth (egg stage), leaf rollers	Bartlett Superior 70 Oil (Dormant Oil) • general cleanup spray	Apply before or after bud break (this stage or silver tip stage) • max 1x application/year
	<i>Entomosporium</i> Leaf & Berry Spot	Kumulus DF (80% sulphur) Microthiol Disperss (80% sulphur)	Apply at bud break & at 10 - 14 day intervals May be necessary if moderate to severe infection in previous year • may be applied at bud break and at 10 - 14 day intervals (1 day PHI) • do not apply within 30 days of mineral oil application • max 8x applications/year
	Bacterial Blight (<i>Pseudomonas syringae</i>) - suppression	Serenade MAX (Biofungicide - <i>Bacillus subtilis</i>) Serenade ASO (Biofungicide - <i>Bacillus subtilis</i>)	Apply before fall rains & again during dormancy

	Pests controlled	Chemicals registered	Other comments
Silver Tip Bud Stage			
	Saskatoon Bud Moth (egg stage), leaf rollers	Bartlett Superior 70 Oil (Dormant Oil)	Spray before bud break (apply at dormant or silver tip stage) • Check bud axils for eggs • Max 1x application/year
	<i>Entomosporium</i> Leaf & Berry Spot	Kumulus DF (80% sulphur) Microthiol Disperss (80% sulphur)	May be necessary if moderate to severe infection in previous year • May be applied at bud break and at 10 - 14 day intervals (1 day PHI) • Do not apply within 30 days of mineral oil application • Max 8x applications/year

NOTE – Listed pesticides are registered for application at the various times indicated; however, producers should consider all relevant factors when making application decisions. Not all applications will be required each season.

Saskatoon Berry Bud/Bloom Staging/Pests/Pesticides

	Pests controlled	Chemicals registered	Other comments
Green Tip Bud Stage			
	Saskatoon Bud Moth (SBM laying eggs; hatching larvae)	Decis 5.0EC (deltamethrin 50g/L)	1st Decis application <ul style="list-style-type: none"> • may be effective as late as tight cluster stage • 21 day PHI
	Tarnished Plant Bug (wintering TPB adults feeding on fruit buds)		
	Other Plant Bugs		
	Saskatoon Bud Moth	Matador 120EC / Warrior (lambda-cyhalothrin 120g/L / 122g/L)	1st of 2 possible applications <ul style="list-style-type: none"> • max 2 applications • 21 day PHI • 10 - 15 days between applications
	<i>Entomosporium</i> Leaf & Berry Spot	Kumulus DF (80% sulphur) Microthiol Disperss (80% sulphur)	May be necessary if moderate to severe infection in previous year <ul style="list-style-type: none"> • may be applied at bud break and at 10 - 14 day intervals (1 day PHI) • do not apply within 30 days of mineral oil application • max 8x applications/year
Mummyberry	Quash / Metconazole 50WDG (metconazole 50%)	12 day PHI Max 1x application Apply at green tip	

NOTE – Listed pesticides are registered for application at the various times indicated; however, producers should consider all relevant factors when making application decisions. Not all applications will be required each season.

Saskatoon Berry Bud/Bloom Staging/Pests/Pesticides

	Pests controlled	Chemicals registered	Other comments
Full Green Stage			
	Saskatoon Bud Moth	Decis 5.0EC (deltamethrin 50g/L) • Delayed timing for SBM control (see Green Tip Stage)	Green tip stage is the preferred stage for application • 21 day PHI
	<i>Entomosporium</i> Leaf & Berry Spot	Kumulus DF (80% sulphur) Microthiol Disperss (80% sulphur)	May be necessary if moderate to severe infection in previous year • may be applied at bud break and at 10 - 14 day intervals (1 day PHI) • do not apply within 30 days of mineral oil application • max 8x applications/year

	Pests controlled	Chemicals registered	Other comments
Tight Cluster Stage			
	Saskatoon Bud Moth	Decis 5.0EC (deltamethrin 50g/L) • Delayed timing for SBM control (see Green Tip Stage)	Green tip stage is the preferred stage for application • 21 day PHI
	<i>Entomosporium</i> Leaf & Berry Spot	Kumulus DF (80% sulphur) Microthiol Disperss (80% sulphur)	May be necessary if moderate to severe infection in previous year • May be applied at bud break and at 10 - 14 day intervals (1 day PHI) • Do not apply within 30 days of mineral oil application • Max 8x applications/year

NOTE – Listed pesticides are registered for application at the various times indicated; however, producers should consider all relevant factors when making application decisions. Not all applications will be required each season.

Saskatoon Berry Bud/Bloom Staging/Pests/Pesticides

	Pests controlled	Chemicals registered	Other comments
White Tip Stage			
	<i>Entomosporium</i> Leaf & Berry Spot	Kumulus DF (80% sulphur) Microthiol Disperss (80% sulphur)	May be necessary if moderate to severe infection in previous year <ul style="list-style-type: none"> • may be applied at bud break and at 10 - 14 day intervals (1 day PHI) • do not apply within 30 days of mineral oil application • max 8x applications/year
	<i>Entomosporium</i> Leaf & Berry Spot – suppression	Switch 62.5WG (cyprodinil 37.5% / fludioxinil 25.0%)	Apply during early bloom – can be applied when petals start to show or earlier (if disease is present) <ul style="list-style-type: none"> • max 3x applications/year
	<i>Entomosporium</i> Leaf & Berry Spot	Jade / Topas / Mission 418 EC (propiconazole 250, 250 or 418g/L)	Persistent cool, wet weather <ul style="list-style-type: none"> • 1st of max 3 applications • apply to point of runoff • 38 day PHI
	Saskatoon Berry / Juniper Rust	Funginex DC (triforine 190g/L)	Spray to point of drip <ul style="list-style-type: none"> • 60 day PHI
	Coincidental control of Brown rot	Pristine WG (boscalid 25.2% / pyraclostrobin 12.8%)	Apply prior to disease development <ul style="list-style-type: none"> • 7 - 14 day interval • max 4x applications/year (2 recommended) • 29 day REI / 0 day PHI
	Oblique-banded leafroller; spanworm; winter moth	Success 480SC / Entrust 80W Naturalyte (spinosad 480g/L / 80%)	Apply at time of egg hatch or to small larvae <ul style="list-style-type: none"> • 7 - 10 day intervals • max 3x applications/year • 3 day PHI • apply higher rate for larger larvae • larvae may become more exposed as buds flush

NOTE – Listed pesticides are registered for application at the various times indicated; however, producers should consider all relevant factors when making application decisions. Not all applications will be required each season.

Saskatoon Berry Bud/Bloom Staging/Pests/Pesticides

	Pests controlled	Chemicals registered	Other comments
Balloon or Tube Stage			
	Saskatoon Bud Moth Tarnished Plant Bug Other Plant Bugs Saskatoon Sawfly Hawthorn Weevil Apple Curculio	Decis 5.0EC (deltamethrin 50g/L) • Toxic to most pollinators	2nd of 3 allowed applications • apply to both sides of orchard rows • apply prior to 25% bloom • 21 day PHI
	Fireblight – suppression	Bloomtime Biological FD Biopesticide (<i>Pantoea agglomerans</i>)	Make 1st of maximum 2 applications at 15 - 20% bloom • 0 day PHI
	<i>Entomosporium</i> Leaf & Berry Spot	Kumulus DF (80% sulphur) Microthiol Disperss (80% sulphur)	May be necessary if moderate to severe infection in previous year • may be applied at bud break and at 10 - 14 day intervals (1 day PHI) • do not apply within 30 days of mineral oil application • max 8x applications/year
	<i>Entomosporium</i> Leaf & Berry Spot – suppression	Switch 62.5WG (cyprodinil 37.5%/fludioxinil 25.0%)	Apply during early bloom – repeat after 7 - 10 days • max 3x applications • 10 day REI
	<i>Entomosporium</i> Leaf & Berry Spot Saskatoon Berry/ Juniper Rust	Jade / Topas / Mission 418EC (propiconazole 250, 250 or 418g/L) Pristine WG (boscalid 25.2%/pyraclostrobin 12.8%)	May be applied as a late 1st application if weather conditions are favourable for disease development Apply prior to disease development • 7 - 14 day intervals • max 4x applications/year (2 recommended) • 29 day REI/0 day PHI
	Powdery Mildew	Nova 40W (myclobutanil 40%)	Spray until drip • 1st of max 3 applications/year • 14 day PHI

NOTE – Listed pesticides are registered for application at the various times indicated; however, producers should consider all relevant factors when making application decisions. Not all applications will be required each season.

Saskatoon Berry Bud/Bloom Staging/Pests/Pesticides

	Pests controlled	Chemicals registered	Other comments
Early Flowering Stage			
	Saskatoon Bud Moth Tarnished Plant Bug Other Plant Bugs Saskatoon Sawfly Hawthorn Weevil Apple Curculio	Decis 5.0EC (deltamethrin 50g/L) • Toxic to most pollinators	2nd of max 3 allowed applications • Apply prior to 25% bloom • Apply to both sides of orchard rows • 21 day PHI
	Fireblight - suppression	Bloomtime Biological FD Biopesticide (<i>Pantoea agglomerans</i>)	Make 1st of maximum 2 applications at 15 - 20% bloom

	Pests controlled	Chemicals registered	Other comments
Full Flower Stage			
	Insect pollination is considered beneficial for fruit set - pesticide application during flowering can significantly injure pollinators	No pesticides or fungicides should be applied during full bloom	• insecticides are toxic to pollinators • some fungicides (e.g. sulphur) can have a repellent effect

NOTE – Listed pesticides are registered for application at the various times indicated; however, producers should consider all relevant factors when making application decisions. Not all applications will be required each season.

Saskatoon Berry Bud/Bloom Staging/Pests/Pesticides

	Pests controlled	Chemicals registered	Other comments
Petal Fall Stage			
	Fireblight (suppression)	Bloomtime Biological FD Biopesticide (<i>Pantoea agglomerans</i>)	Make 2nd of max 2 applications at full bloom to petal fall • 0 day PHI
	<i>Entomosporium</i> Leaf & Berry Spot - suppression	Switch 62.5WG (cyprodinil 37.5% / fludioxinil 25.0%)	• apply 7 - 10 day intervals • max 3x applications • 10 day REI
	<i>Entomosporium</i> Leaf & Berry Spot	Kumulus DF (80% sulphur) Microthiol Disperss (80% sulphur)	May be necessary if moderate to severe infection in previous year • may be applied at bud break and at 10 - 14 day intervals (1 day PHI) • do not apply within 30 days of mineral oil application • max 8x applications/year
	<i>Entomosporium</i> Leaf & Berry Spot Saskatoon Berry / Juniper Rust	Jade / Topas / Mission 418EC (propiconazole 250, 250 or 418g/L)	Persistent cool, wet weather • 2nd of max 3 applications • apply to point of runoff • 38 day PHI
	Some coincidental control of Brown rot may be expected	Pristine WG (boscalid 25.2% / pyraclostrobin 12.8%)	Apply prior to disease development • 7 - 14 day intervals • max 4x applications/year (2 recommended) • 29 day REI / 0 day PHI

NOTE – Listed pesticides are registered for application at the various times indicated; however, producers should consider all relevant factors when making application decisions. Not all applications will be required each season.

Saskatoon Berry Bud/Bloom Staging/Pests/Pesticides

	Pests controlled	Chemicals registered	Other comments
Early Green Fruit Stage			
	Hawthorn Weevil Apple Curculio • adult weevils and ovipositing curculio	Decis 5.0EC (deltamethrin 50g/L)	3rd of max 3 allowed applications • apply 5 - 10 days after petal fall • apply to both sides of orchard rows • 21 day PHI
	Saskatoon Bud Moth	Matador 120EC / Warrior (lambda-cyhalothrin 120g/l / 122g/L)	2nd possible application (after petal fall) • max 2 applications • 21 day PHI • 10 - 15 days between applications
	Powdery Mildew	Nova 40W (myclobutanil 40%)	Spray until drip • 2nd of max 3 applications/year • 14 day PHI
	<i>Entomosporium</i> Leaf & Berry Spot	Kumulus DF (80% sulphur) Microthiol Disperss (80% sulphur)	May be necessary if moderate to severe infection in previous year • may be applied at bud break and at 10 - 14 day intervals (1 day PHI) • do not apply within 30 days of mineral oil application • max 8x applications/year
	<i>Entomosporium</i> Leaf & Berry Spot Saskatoon Berry/ Juniper Rust	Jade/Topas/Mission 418EC (propiconazole 250, 250 or 418g/L)	Persistent cool, wet weather • 3rd of max 3 applications • apply to point of runoff • 38 day PHI
	Some coincidental control of Brown rot may be expected	Pristine WG (boscalid 25.2% / pyraclostrobin 12.8%)	Apply prior to disease development • 7 - 14 day intervals • max 4x applications/year (2 recommended) • 29 day REI / 0 day PHI



NOTE – Listed pesticides are registered for application at the various times indicated; however, producers should consider all relevant factors when making application decisions. Not all applications will be required each season.

Saskatoon Berry Bud/Bloom Staging/Pests/Pesticides

	Pests controlled	Chemicals registered	Other comments
Late Green Fruit Stage			
	Powdery Mildew	Nova 40W (myclobutanil 40%)	Spray until drip <ul style="list-style-type: none"> • 3rd of max 3 applications/year • 14 day PHI
	<i>Entomosporium</i> Leaf & Berry Spot	Kumulus DF (80% sulphur) Microthiol Disperss (80% sulphur)	May be necessary if moderate to severe infection in previous year <ul style="list-style-type: none"> • may be applied at bud break and at 10 - 14 day intervals (1 day PHI) • do not apply within 30 days of mineral oil application • max 8x applications/year
	<i>Entomosporium</i> Leaf & Berry Spot Saskatoon Berry/ Juniper Rust Coincidental control of Brown rot may be expected	Pristine WG (boscalid 25.2% / pyraclostrobin 12.8%)	<ul style="list-style-type: none"> • may be applied at this stage rather than early green fruit stage - disease pressure related • 29 day REI / 0 day PHI

NOTE – Listed pesticides are registered for application at the various times indicated; however, producers should consider all relevant factors when making application decisions. Not all applications will be required each season.

Saskatoon Berry Bud/Bloom Staging/Pests/Pesticides

	Pests controlled	Chemicals registered	Other comments
Red Fruit Stage			
	<i>Entomosporium</i> Leaf & Berry Spot	Kumulus DF (80% sulphur) Microthiol Disperss (80% sulphur)	<p>May be necessary if moderate to severe infection in previous year</p> <ul style="list-style-type: none"> • may be applied at bud break and at 10 - 14 day intervals (1 day PHI) • not recommended at late stages due to strong sulphur odours • do not apply within 30 days of mineral oil application • max 8x applications/year
Mature Fruit Stage (approx. mid July) *			
	<i>Entomosporium</i> Leaf & Berry Spot	Kumulus DF (80% sulphur) Microthiol Disperss (80% sulphur)	<p>May be necessary if moderate to severe infection in previous year</p> <ul style="list-style-type: none"> • may be applied at bud break and at 10 - 14 day intervals (1 day PHI) • not recommended at late stages due to strong sulphur odours • do not apply within 30 days of mineral oil application • max 8x applications/year
	<p>Woolly Elm Aphid - suppression</p> <p>Woolly Apple Aphid - suppression</p>	<p>Admire 240F (imidacloprid 240g/L) (systemic insecticide)</p> <p>Alias 240SC (imidacloprid 240g/L) (systemic insecticide)</p>	<p>Apply as a soil drench when 75 - 100% of aphid migration is completed (typically early to mid-July)</p> <ul style="list-style-type: none"> • 14 day PHI
* Depending on season and location			

NOTE – Listed pesticides are registered for application at the various times indicated; however, producers should consider all relevant factors when making application decisions. Not all applications will be required each season.

Saskatoon Berry Bud/Bloom Staging/Pests/Pesticides

	Pests controlled	Chemicals registered	Other comments
Post-Harvest Stage (Late July – Early August) *			
	Woolly Elm Aphid Woolly Apple Aphid	Orthene 75% SP (acephate) (systemic insecticide)	Inject with a probe 15cm (6 inch) from plant at 4 locations around each plant <ul style="list-style-type: none"> • apply 1x per season (mid-July to early August) • 11 month PHI
	* Depending on season and location		

NOTE – Listed pesticides are registered for application at the various times indicated; however, producers should consider all relevant factors when making application decisions. Not all applications will be required each season.

1.12 Herbicides currently registered for fruit crops in western Canada

Active Ingredient	Trade Name*	Pre-Harvest Interval	Vegetation Control**
Dichlobenil	Casoron G4 / G2 Stryke 4G	Apply in fall but not before freeze-up. Do not apply within 9 months of harvest. Soil temperatures should be less than 10°C Some moisture is necessary to incorporate and stabilize product in the soil	<ul style="list-style-type: none"> Broadleaf & grasses: annual bluegrass, chickweed, crabgrass, foxtail, groundsel, knotweed, kochia, lamb's quarters, mustard, plantain, purslane, pigweed, shepherd's purse, smartweed, spurge, wild buckwheat Perennial weeds: artemesia, bindweed, blue aster, dandelion, horsetail, loosestrife, nutsedge, quackgrass, sheep sorrel, Canada thistle, sow thistle, vetch
Glyphosate	Factor Renegade Roundup Dry Roundup Original Roundup Transorb Touchdown 480, 600, XP Vantage Vantage Plus	Apply pre-planting or to non-crop areas	<ul style="list-style-type: none"> Non-selective: refer to product label for a complete list of specific vegetation controlled
Linuron	Linuron 480 / 400L Lorox DF / L	Spring (Pre-budbreak - 50 day PHI) or Fall (dormant plants) for established orchards - 1 year	<ul style="list-style-type: none"> Broadleaf: chickweed, corn spurry, goosefoot, groundsel, knotweed, lamb's quarters, purslane, ragweed, redroot pigweed, shepherd's purse, smartweed, stinkweed, wild buckwheat, wormseed mustard; seedlings of dandelion, plantain, sow thistle Grasses: suppression of barnyard grass and green foxtail

*Trade names change from time to time. If the product is not available choose a registered product with the appropriate active ingredient for your weed problem. Consult product labels for complete application information.

** Consult product label for complete list of weed species that may be controlled by each product
Adapted and updated (2008) from *Herbicides Registered for Fruit Crops* (Peters, 2003).

1.12 Herbicides currently registered for fruit crops in western Canada

Active Ingredient	Trade Name*	Pre-Harvest Interval	Vegetation Control**
Metribuzin	Sencor 480F Sencor 500F Sencor 75DF Sprayule Sencor Solupak 75DF Tricor 75DF	For use in Saskatoon berry shelterbelts Pre-plant incorporated and pre-emergent	<ul style="list-style-type: none"> • Broadleaf: chickweed, cocklebur, dandelion seedling, lady's thumb, lamb's quarters, prostrate and redroot pigweed, ragweed, Russian thistle, shepherd's purse, stinkweed, wild buckwheat, wild mustard • Suppresses: corn spurry, hemp nettle • Grasses: barnyard grass, green and yellow foxtail, down brome grass (cheatgrass)
Paraquat	Gramoxone	N/A	<ul style="list-style-type: none"> • Non-selective: Controls most annual and perennial weeds germinating from seed; controls suckers
Sethoxydim	Poast Ultra	For use in Nurseries - non-bearing For use in bearing orchards - 15 day PHI	<ul style="list-style-type: none"> • Annual grasses: barnyard grass, green and yellow foxtail, Persian darnel, volunteer cereals, wild millet, wild oats • Suppresses / Controls (depending on rate): witchgrass, quack grass, foxtail barley
Trifluralin	Bonanza 400 / 480L Treflan EC	Pre-plant incorporated	<ul style="list-style-type: none"> • Broadleaf & grasses: annual brome species, barnyard grass, chickweed, cow cockle, green foxtail, knotweed, lamb's quarters, Persian darnel, pigweed, purslane, wild buckwheat, wild oats, yellow foxtail

*Trade names change from time to time. If the product is not available choose a registered product with the appropriate active ingredient for your weed problem. Consult product labels for complete application information.

** Consult product label for complete list of weed species that may be controlled by each product

Adapted and updated (2008) from *Herbicides Registered for Fruit Crops* (Peters, 2003).

1.13 Plastic Mulch for Berry Orchards

Reprinted with permission from PFRA Shelterbelt Centre, Indian Head, SK.



Plastic Mulch for Saskatoon Berry Orchards

Why use Mulches?

Mulching can improve growth and hasten fruit production of saskatoon berries as well as control weeds and conserve soil moisture.

Project Funding
Pest Management Alternatives Office

Controlling weeds in saskatoon and other bush fruit orchards can be time consuming and frustrating, but is essential for successful orchard establishment and fruit production. Traditional weed control methods include mechanical cultivation, hand weeding and herbicides. The use of mulches presents an ecological alternative to these methods. Mulching plants to mitigate adverse temperatures and moisture loss, or control weeds has been an accepted horticulture practice for centuries. Many mulch materials have been used including sawdust, sand, woodchips, newspapers, straw and plastic.

A research study conducted by the Saskatchewan Fruit Growers Association and the Prairie Farm Rehabilitation Administration (PFRA) Shelterbelt Centre has shown that mulching can improve growth and hasten fruit production of saskatoon berries as well as control weeds and conserve soil moisture. The study compared different mulches including polypropylene plastic, polyethylene plastic, flax shives and wood chips. Results conclusively demonstrated that plastic mulches were the best choice for mulching saskatoon orchards. Similar results can be expected with other bush fruits as well as shelterbelt plantings.



What is Plastic Mulch?

Plastic mulch is ultraviolet stabilized black polypropylene or polyethylene. The plastic is available in rolls of various lengths and widths. Longevity ranges from 5 to 10 years depending on quality and local conditions. Plastic can be permeable or impervious to moisture depending on the manufacturer.

Benefits of Plastic Mulch

- Black plastic suppresses weed growth primarily by blocking light necessary for photosynthesis and to a lesser extent by mechanically impeding growth. Labour and chemical costs associated with weed control are reduced significantly.
- Plastic blocks evaporation and increases the amount of water available to trees by suppressing competing vegetation. Although soil dries under impermeable plastic it does rewet within a few days after rainfall.
- Mulching reduces erosion by wind and water, reduces soil compaction and nutrient leaching.
- Plastic mulch increases soil temperature by absorbing incoming solar energy and prevents the soil from cooling by blocking evaporation. Mulched soil thaws several days earlier in the spring resulting in an extended growing season.
- Plastic improves seedling survival and growth by providing a growing environment that is weed free with adequate moisture. Plastic enhances early root growth resulting in deeper rooted plants. Plastic can result in earlier onset of fruit production. Research showed that 22 percent of saskatoon plants in plastic mulch fruited in year 3 compared to 7 percent in unmulched plots.

Types of Plastic

Black Embossed Polyethylene

An ultraviolet-stabilized, embossed, impermeable, black polyethylene material that blocks sunlight and reduces evaporation.

It has the advantage of being lightweight and inexpensive yet durable. Although impermeable, moisture is retained under the plastic and rewets quickly following a rain. The plastic is available in various widths and roll lengths. Currently 1500 foot rolls 4 feet wide are recommended.

Woven Polypropylene

An ultraviolet stabilized woven black polypropylene material that blocks sunlight, but allows moisture, nutrient and oxygen flow. This mulch has the advantage of being tough and durable lasting up to 10 years. The mulch is available in roll lengths of 300 to 500 feet and width of 4, 6 and 10 feet. This plastic is considerably more expensive than embossed polyethylene but is more durable.



Information on a mulch applicator designed at the PFRA Shelterbelt Centre can be obtained by contacting the Centre.

Equipment Requirements

Plastic mulch requires mechanical application. The rolled plastic is designed to be applied using three point hitch mounted applicators. Hand application is difficult and seldom successful. Applicators are available commercially and cost \$1500 to \$2000. Information on a mulch applicator designed at the PFRA Shelterbelt Centre can be obtained by contacting the Centre.

Mulch Application

Taking time to properly apply the plastic will go a long way in ensuring the longterm success of using plastic.

Planting sites need to be well prepared prior to application of plastic. Best results are obtained if the soil has been pre-worked to a depth of 15 to 20 centimetres (6 to 8 inches) prior to planting the seedlings. If machine planting, the planting furrows should be smoothed leaving a level surface for applying the mulch.

Apply plastic shortly after planting the seedlings. The applicator buries the edges of the plastic securing it and keeping it tightly fitted over the soil surface.

An X-slit is made in the plastic at each seedling. The seedling is then pulled through the slit. Pull seedlings through the plastic immediately after it is laid. Seedlings can burn on hot days if left under plastic for even 5 to 10 minutes.

Secure plastic at each seedling using a rock or wire staple. This ensures plastic is in contact with soil around the seedling which helps to direct moisture to the seedling and limits weed growth at the opening.



Taking time to properly apply the plastic will go a long way in ensuring the longterm success of using plastic.



Pull seedlings through the plastic immediately after it is applied.

Other Considerations

Weeds growing along edges of the mulch can be hand weeded or controlled with herbicides. Do not use rototillers or cultivators as plastic can be easily dislodged. Weed growth around seedlings may have to be removed by hand.

Grass sown between rows helps to keep mulch in place and reduces weed growth. Grass can be mowed right up to the mulch. Non-competitive low maintenance grass species such as sheep fescue are ideal choices.

Plastic will inhibit suckering of saskatoons, preventing the development of a continuous hedge. This can be alleviated by making larger slits in the plastic as the trees develop or by planting seedlings at a closer spacing.

Rodents (mice) and pocket gophers may be a problem under mulch if populations are high. To minimize damage keep grass mowed or remove weeds adjacent to the plastic and place poison bait stations under the mulch.

Little maintenance of plastic is required under normal conditions. Damaged or ripped mulch should be repaired and secured to the soil using staples.

Mulch Durability

Proper installation has a significant effect on mulch durability. Improperly installed plastic that is not anchored properly will not be as effective or last as long. Animal (ie. deer puncturing plastic) or hail damage can reduce the longevity of mulches. Under normal conditions, because of built in UV inhibitors and shading of plastic by the trees, breakdown and deterioration of plastic may not occur for many years.

For further information contact:

PFRA Shelterbelt Centre
Indian Head, Sask.
S0G 2K0
Telephone (306) 695-2284
Fax (306) 695-2568

OR

Saskatchewan Fruit Growers Association
Box 218, White City, Sask.
S0G 5B0
Telephone (306) 771-2921





Alberta
Government

AGDEX 238/20-2
Printed in Canada