



# Mandatory Entry-Level Training (MELT)

---

Commercial Truck Driver Training Course: CLASS 1

March, 2019

Alberta

# Table of Contents

Module 1

Module 3

Module 5

Module 2

Module 4



Alberta

# Table of Contents

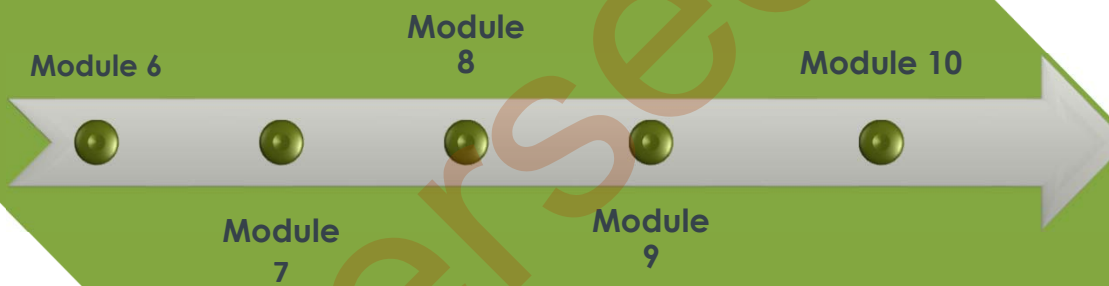

Alberta

# Goal of MELT





# Learning Environment

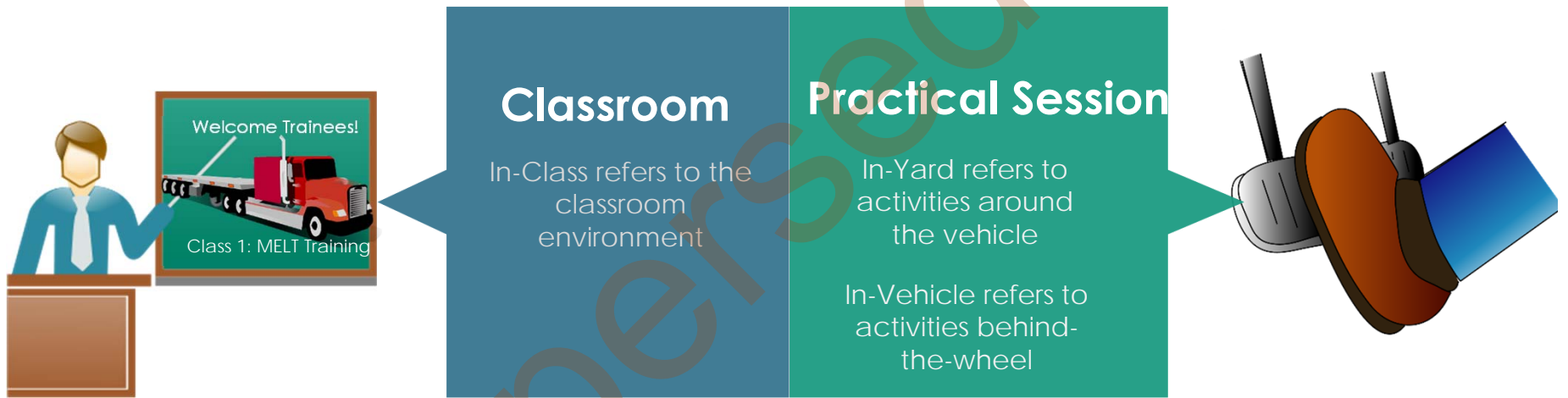

# Course Hours

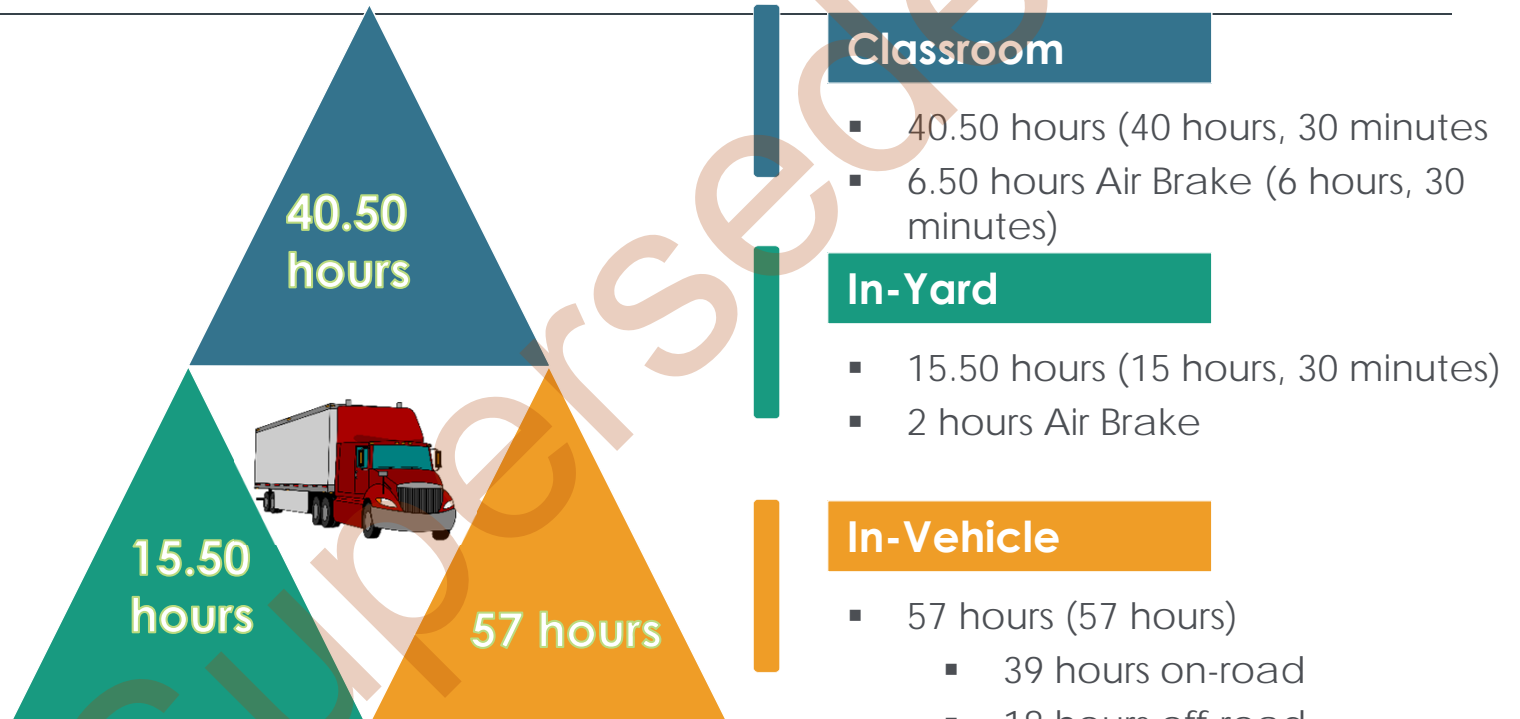

# Prerequisites

---

✓ 18 years of age 

✓ **Hold an Alberta non-probationary driver's licence** 

**Strongly Recommended: Medical Assessment** 

# Course Modules

Module 1	Employment in the Trucking Industry
Module 2	Vehicle Components and Systems
Module 3	Basic Driving Techniques
Module 4	Professional Driving Habits
Module 5	Off-Road Tasks and Manoeuvres
Module 6	Documents, Paperwork, and Regulatory Requirements
Module 7	Vehicle Inspection Activities
Module 8	Hours of Service Compliance
Module 9	Cargo Securement and Loss Prevention
Module 10	Handling Emergencies

# Module 1: Employment in the Trucking Industry

Supersized



# Purpose

## Module 1:

- ✓ Introduction to the trucking industry
- ✓ Familiarize trainees with the various government regulations and standards
- ✓ Outline the licensing requirements and legal responsibilities of a commercial truck driver
- ✓ Requirements, expectations, laws, & regulations that apply to employers & employees working in the industry
- ✓ Laws governing the operation of commercial vehicles



1 hour

### Delivery

- ✓ Lecture, pairs, group, demo, etc.

### Assess

- ✓ Show, do, quiz, test, etc.

25 min

Alberta

# Learning Outcomes

1

- Understand your roles and responsibilities as professional drivers

2

- Understand the requirements and process of obtaining Class 1 driver's licence

3

- Understand the regulations that govern driving on public roads and highways in Alberta

4

- Understand the federal and provincial laws governing the operation of trucks in Alberta

# Trucking Industry and Career Opportunities

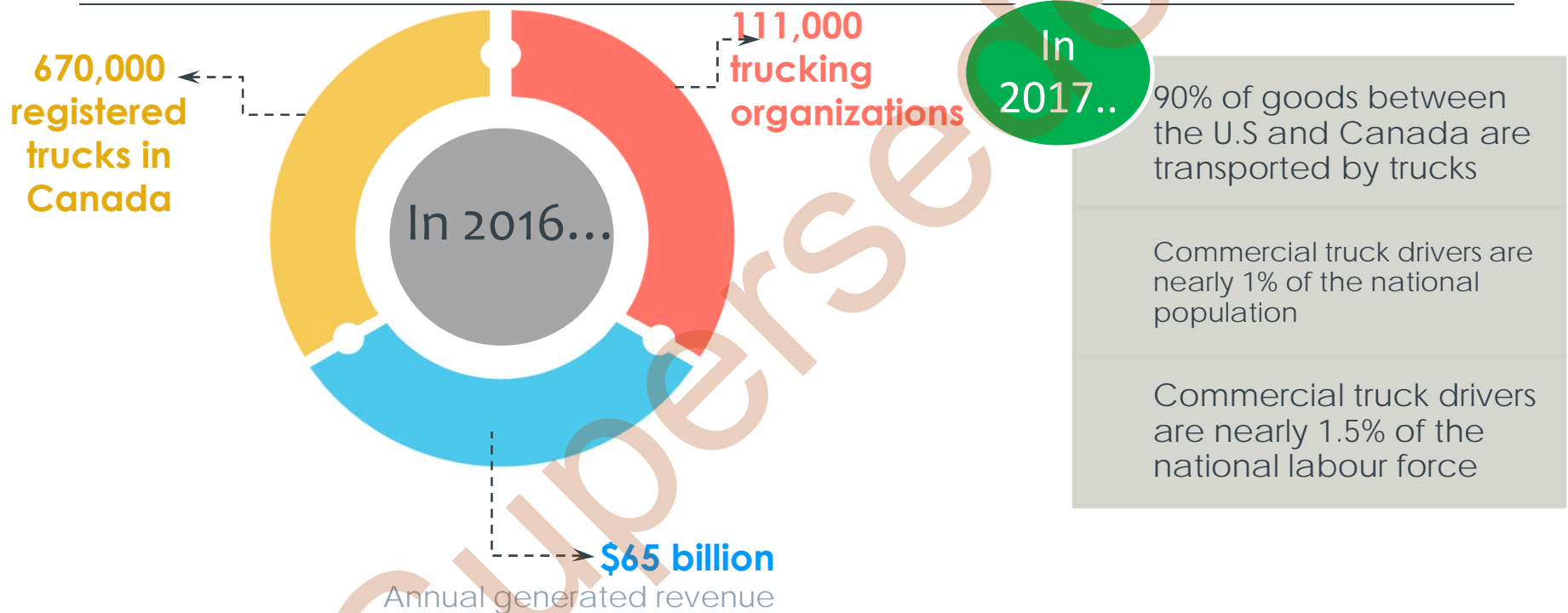

Truck drivers are important to the growth of the economy. A lack of truck drivers may have significant impact of the economy and way of life of the people

# A Brief History of the Canadian Trucking Industry

- Trucking industry has significantly evolved in last century in terms of the kind of truck, technological improvements
  - Transportation of good by team of oxen and horse pulling wagons and carts
- Construction of railroad to connect the eastern region of the country to the western region
- Trucking was introduced in the early 1900s to fill this gap



# Employment in the Trucking Industry

---

- “Good” drivers vs “Poor” drivers
- What are employers looking for?
- *The Commercial Carrier Record-keeping and Commercial Vehicle Driver Reporting Regulations*



# Employment in the Trucking Industry

Employers may request the following

After employment, employers are required to provide additional training

- A completed employment application form
- Personal & Commercial Driver's Abstract
- Submission of medical fitness certificate
- Criminal Record Check
- Records of your previous work experience
- Drug Testing

# Roles & Responsibilities of a Commercial Truck Driver

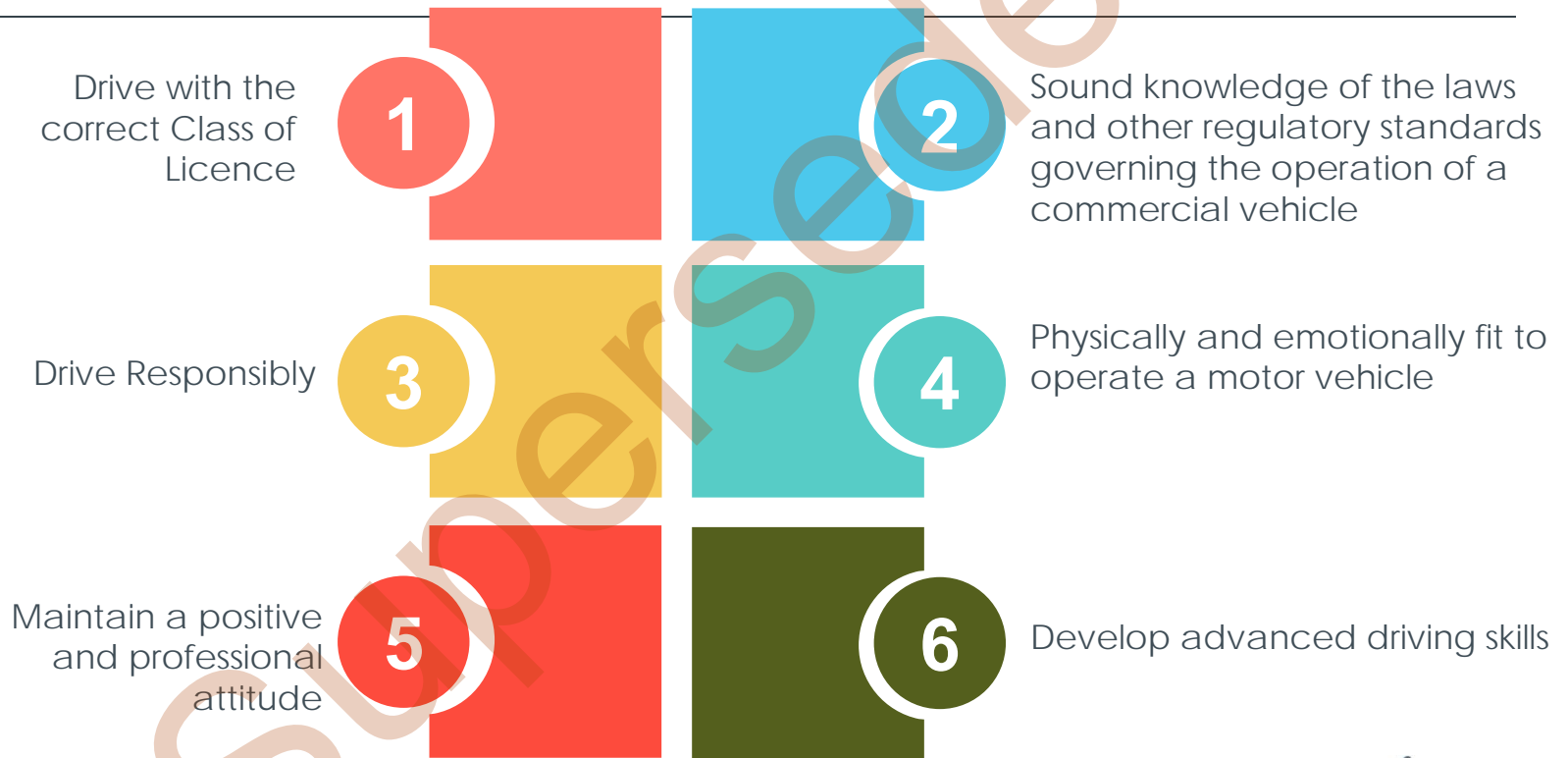

# Licensing



## Note

Air brake or Q- endorsement is required prior to operating or testing in a vehicle equipped with air brakes.

### Enhanced Knowledge Test



After successful completion of this course, trainees will be required to complete an enhanced knowledge test at any registry agent office in Alberta

### Class 1 Road Test



After successful completion of the Class 1 knowledge test, trainees can schedule their Class 1 road test

### Class 1 Driver's Licence



A Class 1 driver's licence will be issued after successful completion of the road test.

### Class 1 Licence Holder



The holder of a Class 1 driver's licence can operate:

- ✓ A motor vehicle or a combination of vehicles, other than a motorcycle;
- ✓ Class 6 type vehicles for learning only.

## Licensing (cont)

---

- Class 1 driver's licence will be issued after successful completion of the road test
  - Restrictions may apply
- The holder of a Class 1 driver's licence can operate a motor vehicle or a combination of vehicles, other than a motorcycle

# Medical Condition

---



## Requirements for Commercial Vehicles

- ✓ Legally responsible to report any disease or disability
- ✓ Medical report required:
  - First time applying for a driver's licence
  - Upgrading a driver's licence to a Class 1, 2, 2-S or 4
  - Every 5 years after that, until 45 years of age
  - Every 2 years from age 45 to 65
  - Every year after you turn age 65



# Traffic Laws/Regulations

Use of the Highway  
and Rules of the  
Road Regulation

Demerit Point  
Program and Service  
of Documents  
Regulation

Vehicle  
Equipment  
Regulation

Distracted  
Driving  
Regulation

Traffic Control  
Device  
Regulation

Drivers Hours of  
Service Regulation

Operator Licensing  
and Vehicle Control  
Regulation

Commercial Vehicle  
Certificate and  
Insurance Regulation

Commercial Vehicle  
Safety Regulation

Commercial Vehicle  
Dimension and  
Weight Regulation

Vehicle Inspection  
Regulation

Bill of Lading and  
Condition of  
Carriage  
Regulation



Province of Alberta

**TRAFFIC SAFETY ACT**

*Alberta*

# National Safety Code (NSC)

---

## Federal Law

A truck, tractor, or trailer or any combination of these vehicles registered for or weighing in excess of 4,500 kilograms

A commercial passenger vehicle with an original manufacturer's seating capacity of 11 or more persons including the driver

## Provincial Law

A truck, tractor, or trailer or any combination of these vehicles registered for a weight of 11,794 kilograms or greater

A commercial passenger vehicle with an original manufacturer's seating capacity of 11 or more persons including the driver



- ✓ There is both **provincial** and **federal** NSC legislation that may require a carrier to obtain a Safety Fitness Certificate (SFC)
- ✓ Only **one** piece of legislation will apply to a carrier at any given time

# National Safety Code (NSC)

Single Driver's Licence Concept

Knowledge/ Performance Tests

Driver Examiner Training program

Classified Driver Licence system

Self-Certification Standards and Procedures

Medical Standards for Drivers

Carrier and Driver Profiles

Short-Term Suspension

Hours of Service

Cargo Securement

Commercial Vehicle Maintenance and Inspection (PMVI)

Commercial Vehicle Safety Alliance (CVSA) On-Road Inspections

Trip Inspection

Safety Rating

Facility Audits

First Aid Training

# Traffic Laws

---

- Alberta *Traffic Safety Act* -  
<http://www.qp.alberta.ca/documents/Acts/t06.pdf>
- Municipalities
- Your responsibility to know

# Criminal Code of Canada

- Impaired Driving
- Leaving the Scene of a Collision
- Failure to provide a breath or blood sample
- Impaired driving causing bodily harm
- Impaired driving causing death
- Driving while suspended or disqualified





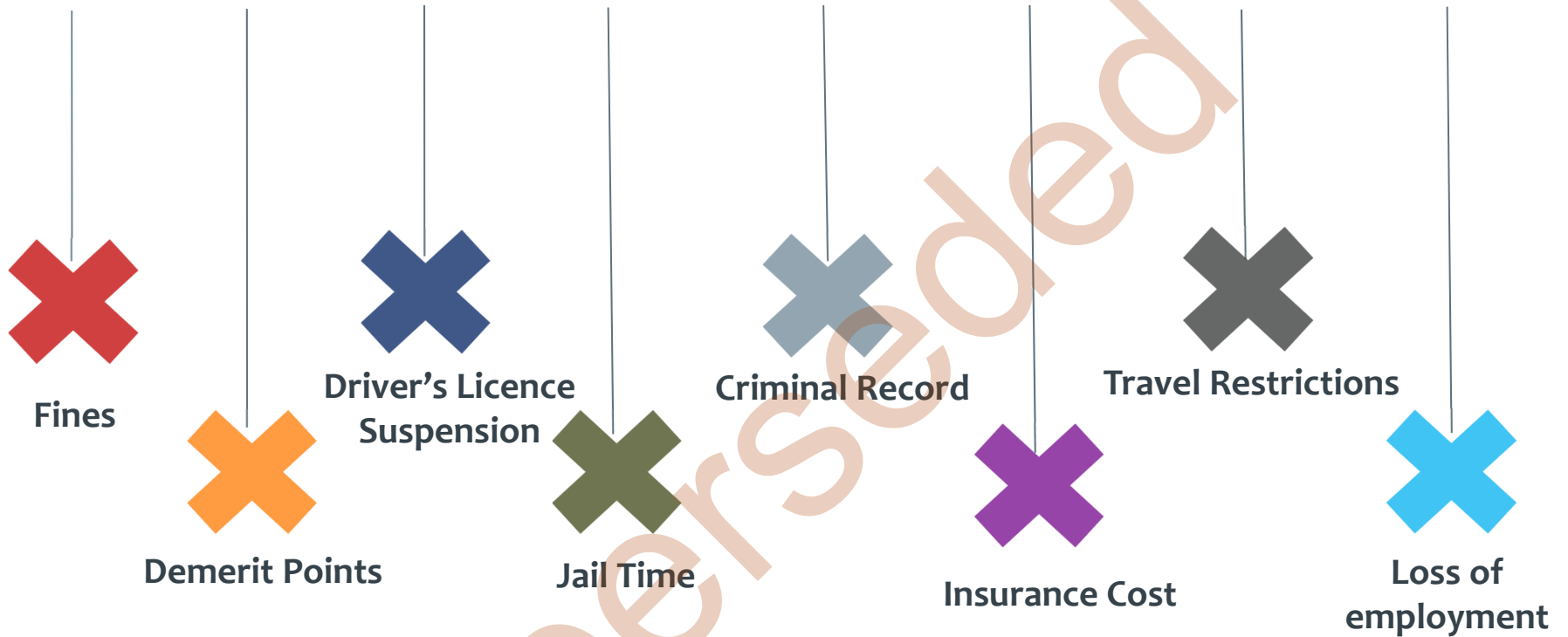

# Traffic Convictions

# Transporting Dangerous Goods

---

Drivers who transport dangerous goods in Alberta must comply with both provincial and federal standards

- Alberta Provincial Dangerous Goods Transportation and Handling Act and Dangerous Goods Transportation and Handling Regulation as well as the Federal Transportation of Dangerous Goods Regulation (TDG).

# Nine (9) hazard classes of dangerous goods



Class 1 Explosives



Class 2 Gases



Class 3 Flammable Liquids



Class 4 Flammable Solids, Substances Liable to Spontaneous Combustion, and Substances that Emit Flammable Gases on Contact with Water



Class 5 Oxidizing Substances and Organic Peroxides



Class 6 Toxic Substances and Infectious Substances



Class 7 Radioactive Materials



Class 8 Corrosive Materials



Class 9 Miscellaneous Products or Substances

# Transporting Dangerous Goods Cont.

---

- Training required to transport
- Certification requirements
- If you change employers

# Summary

---

- Drivers Responsibilities
- Violations and Consequences
- TSA & NSC
- Dangerous Goods

# Review

---

- Who is responsible to ensure the driver has sufficient training on dangerous goods?

## Review - Answer

---

- The Carrier

# Review

Who's responsibility is it to know the laws and company policy and procedures?



# Review - Answer

The Driver

Alberta

---

# Review

How many classes of hazardous materials are there?

# Review - Answer

9 Classes

Alberta

---

# Review

What are demerit points  
and how do you  
accumulate them?

## Review - Answer

They are negative points placed on your licence and they are received from a traffic convictions.

## Review

Why is a driver with a history of traffic convictions considered to be a higher risk to an employer?

## Review

They cost more to ensure and could potentially end up costing the company if they continue to receive tickets or have collisions.

## Summary

- Commercial drivers must act in a safe and responsible manner.
- Commercial drivers must be aware and abide by all the laws.
- Commercial drivers must have the appropriate class of driver's licence.
- Violations of laws may result in traffic and/or criminal convictions.
- There are several consequences for traffic violations.
- Traffic convictions may affect employment and future employment of a professional driver.



# Questions?

---



Supersedes

# Module 2 : Vehicle Components and Systems

# Purpose

## Module 2:

- ✓ Identify the basic components and systems of a truck/tractor.
- ✓ Understand the function and safe use of the components and systems.
- ✓ Know how the components and systems work.
- ✓ Understand the importance for drivers to know the basic components of vehicles.

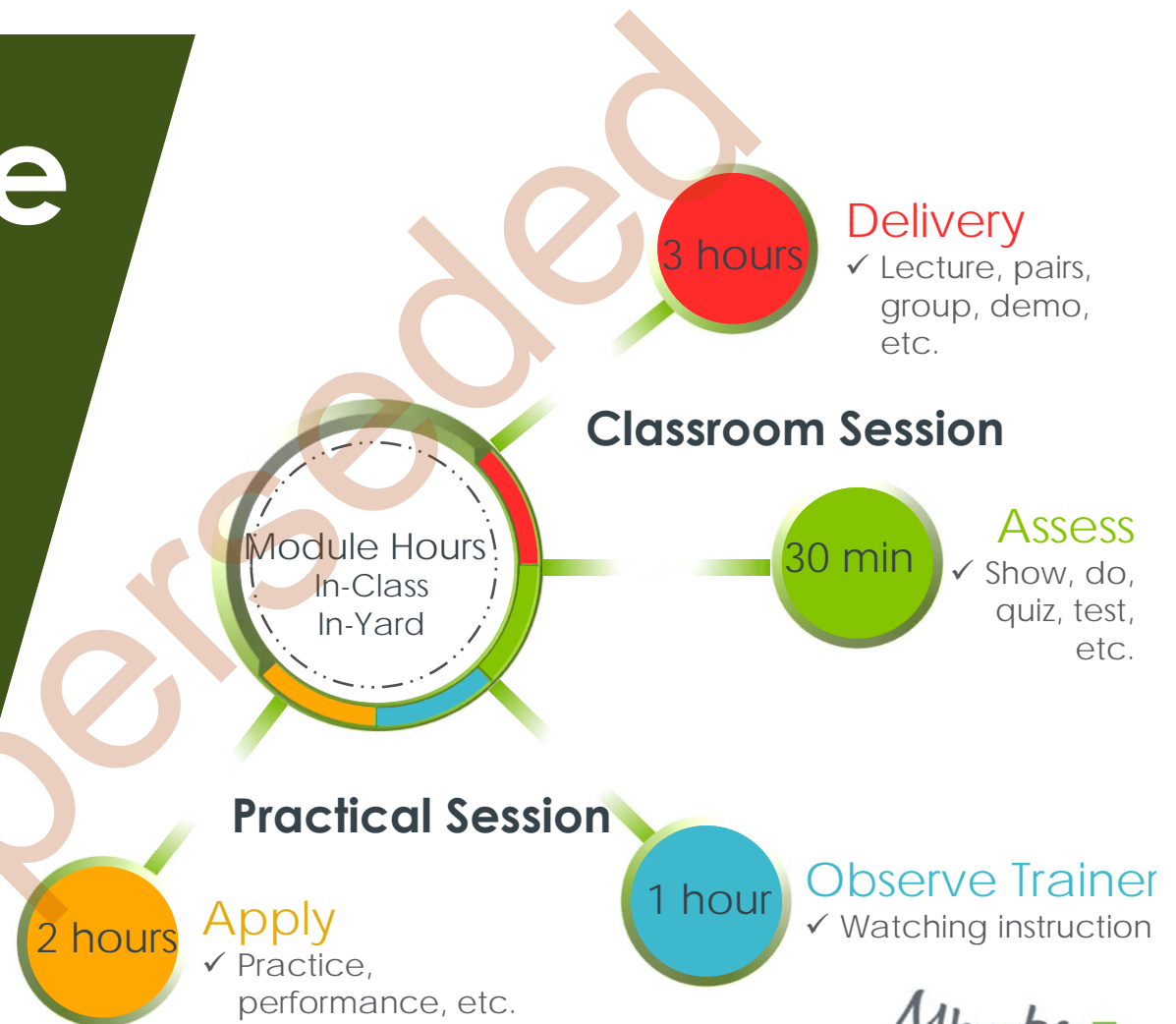

Alberta

## Know Your System and Components

- Primary Vehicle Controls
- Secondary Vehicle Controls
- Engine
- Air Intake and Exhaust Systems
- Lubricating System

## Know Your System and Components

- Electrical System
- Vehicle Body and Frame
- Tires and Wheels
- Coupling System
- Gauges
- Switches



Superseded

## Know Your System and Components

- Some controls, systems and instruments are unique to a truck/tractor trailer and may not be found in other types of vehicles.
- Consult the manufacturer's vehicle manual.

# Components and Systems in a Truck

**Primary Vehicle Controls**

Accelerator Pedal	Transmission	Clutch / Clutch Pedal	Steering Wheel
 A photograph of the accelerator pedal in a truck cab, with a red arrow pointing to it.	<p>It is a box of gears located behind the clutch.</p>	 A photograph of the clutch pedal in a truck cab, with a yellow arrow pointing to it.	<p>It is used to determine the direction of travel of a vehicle in motion</p>

**Note:** The position of the components and systems may vary with truck models

# Components and Systems in a Truck

## Primary Vehicle Controls (Cont.)

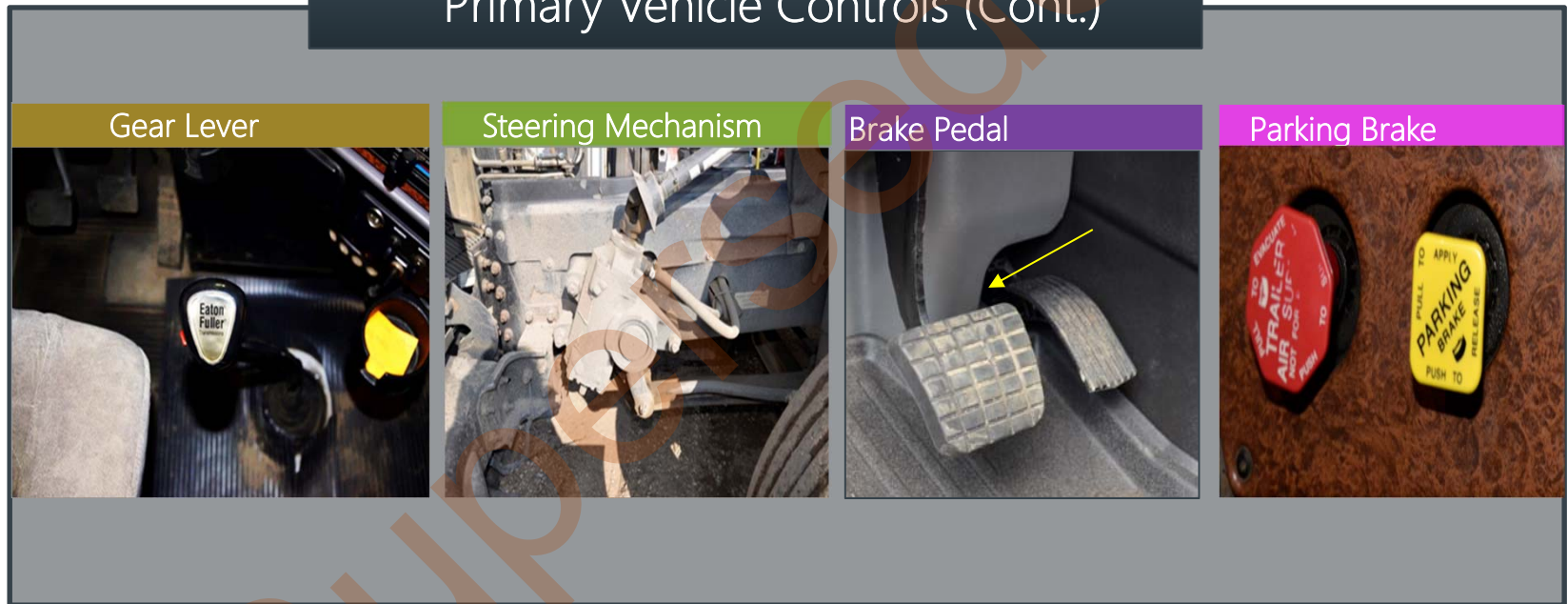

**Note:** The position of the components and systems may vary with truck models



# Components and Systems in a Truck

## Secondary Vehicle Controls

### Exterior Lights/Reflectors



### Air Vents/Air condition/ Heater

Important in safety issues relating to comfort of the driver and other occupants

### Horn

Important in safety issues relating to communication.

### Radio

Important in safety issues relating to communication

**Note:** The position of the components and systems may vary with truck models

# Components and Systems in a Truck

## Secondary Vehicle Controls

### Wiper/Windshield Washer

Important in safety issues relating to vision

### Instrumental Panel



### Interior Lamps

Illuminates the interior of the cab and the dashboard

**Note:** The position of the components and systems may vary with truck models

# Components and Systems in a Truck

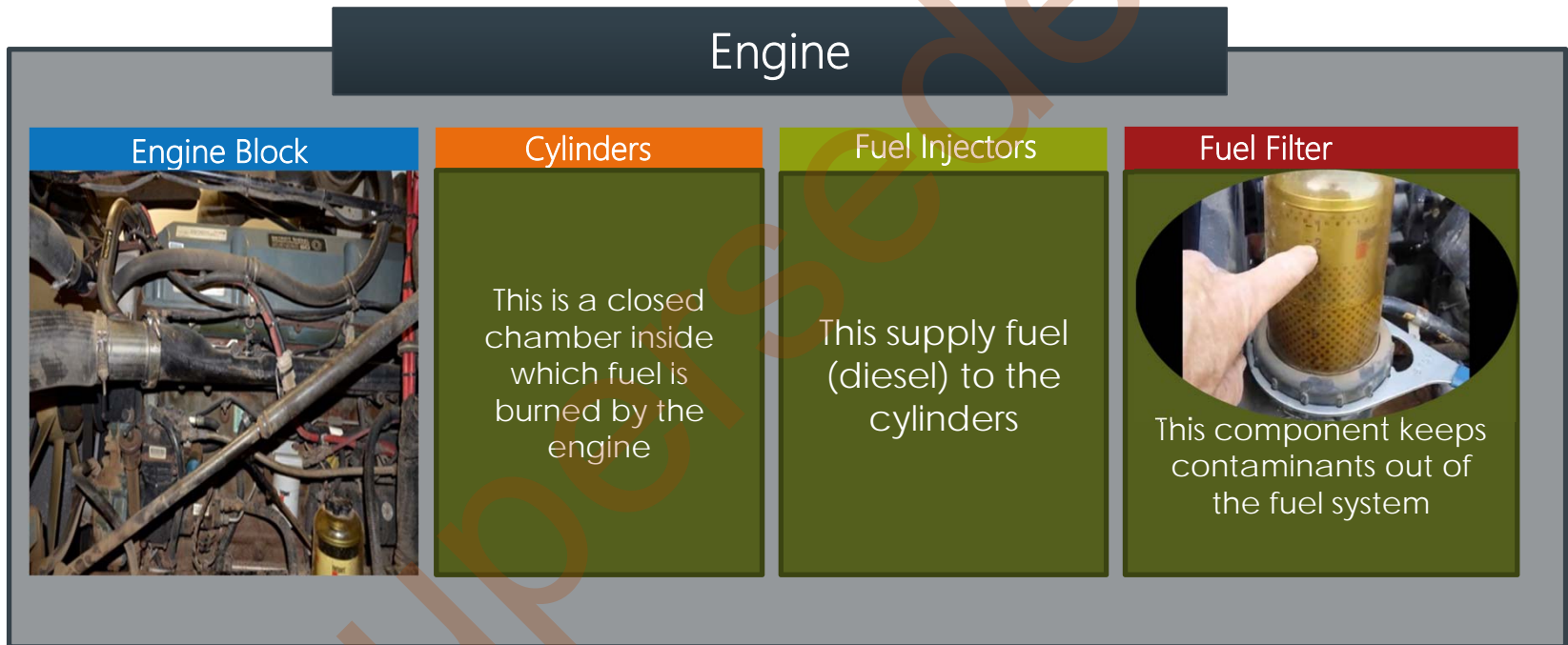

**Note:** The position of the components and systems may vary with truck models

# Components and Systems in a Truck

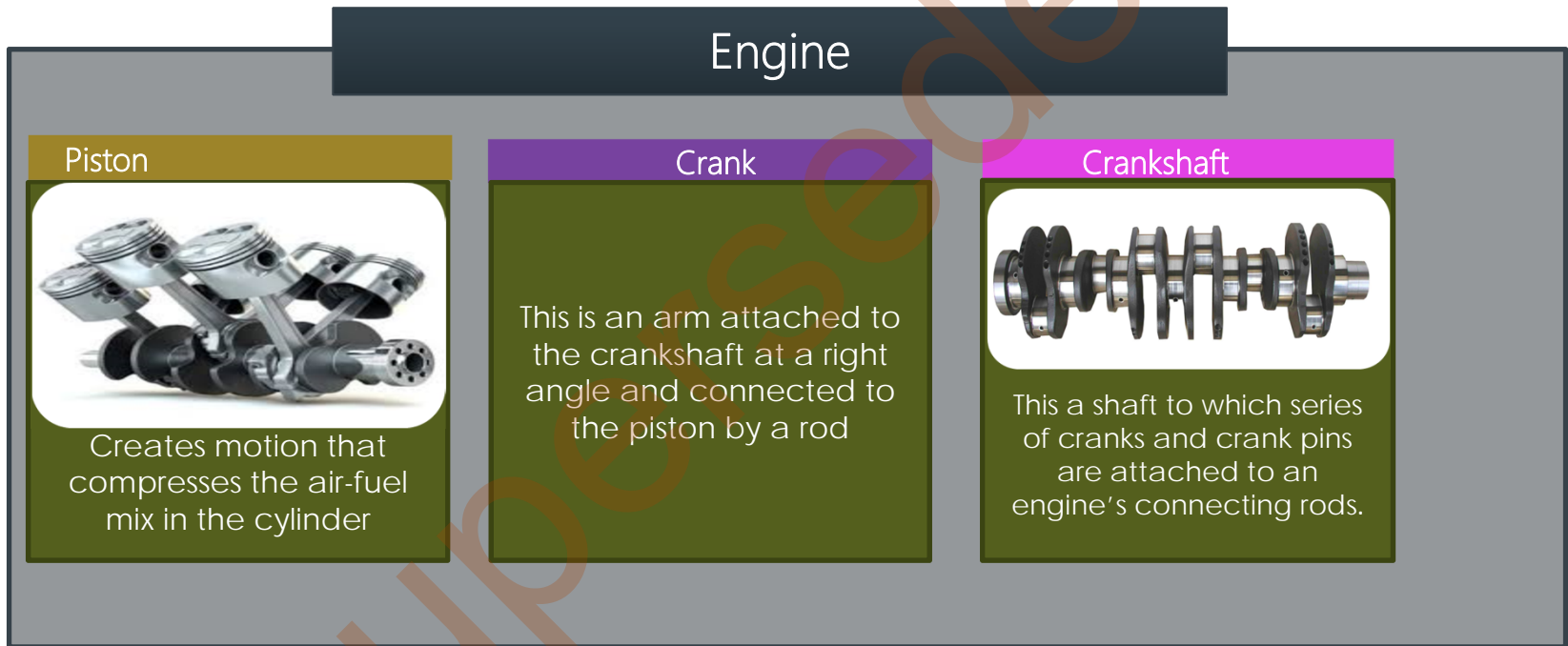

**Note:** The position of the components and systems may vary with truck models

# Components and Systems in a Truck

## Air intake and Exhaust System

Exhaust System



Muffler



Air intake System



**Note:** The position of the components and systems may vary with truck models

# Components and Systems in a Truck

## Air intake and Exhaust System

Turbocharger



Aftercooler

Assists in cooling the intake air received from the turbocharger to a safe temperature level.

**Note:** The position of the components and systems may vary with truck models



# Components and Systems in a Truck

## Lubricating System

Power Steering System



Oil Dip Stick

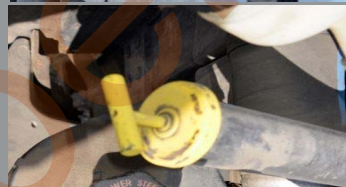

Hoses and Clamps

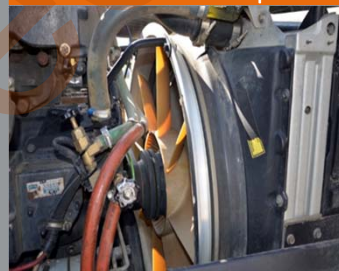

Oil Filter



Removes impurities before they circulate to all the moving components.

**Note:** The position of the components and systems may vary with truck models

# Components and Systems in a Truck

## Cooling System

Radiator



Radiator Cap



Fan Belts and Blades

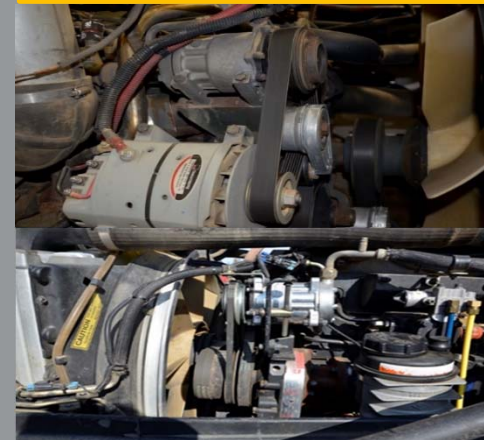

**Note:** The position of the components and systems may vary with truck models



# Components and Systems in a Truck

## Suspension System

Suspension & Frame Attachments



Front tractor axle



# Components and Systems in a Truck

## Suspension System

Rear tractor axle



Single axle



Tandem axle



Tridem axle



# Components and Systems in a Truck

## Suspension System

Drive Shaft



Air Bag Suspension





Shock Absorber



# Components and Systems in a Truck

**Brake Systems**

Hydraulic brake System	Disc Brake System	Drum Brake System
Hydraulic brakes apply instantly		

**Note:** The position of the components and systems may vary with truck models



# Components and Systems in a Truck

## Brake Systems

### Air brake System

Air compressor



Air tanks



Air tank check valve



**Note:** The position of the components and systems may vary with truck models

# Components and Systems in a Truck

## Auxiliary Equipment

Advance warning Triangle



Fire Extinguisher



# Components and Systems in a Truck

## Electrical System

Battery and Battery Cable



Wires



# Components and Systems in a Truck

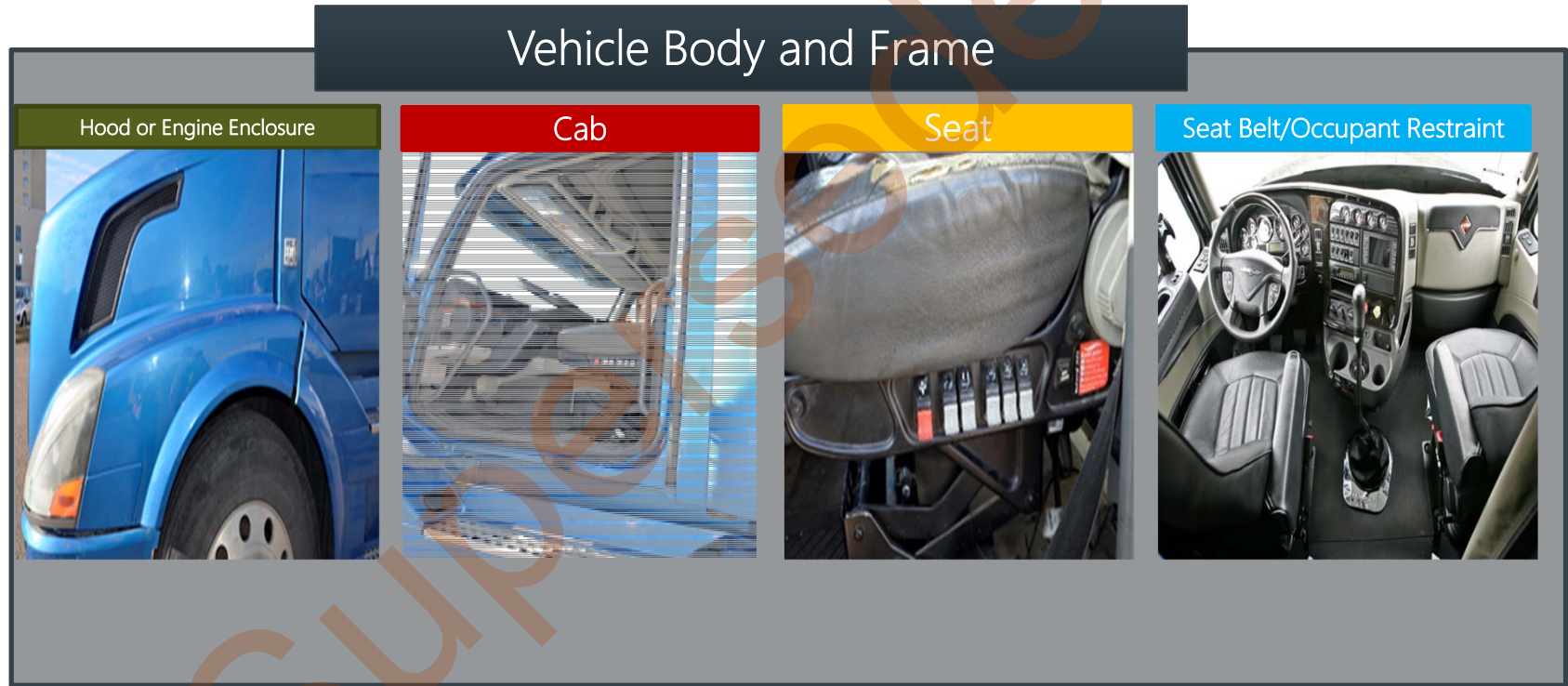



# Components and Systems in a Truck

## Vehicle Body and Frame

Fender/Mud Flap



Mirrors



Fuel Tank Door and Cap



Doors



# Components and Systems in a Truck

## Tires and Wheels

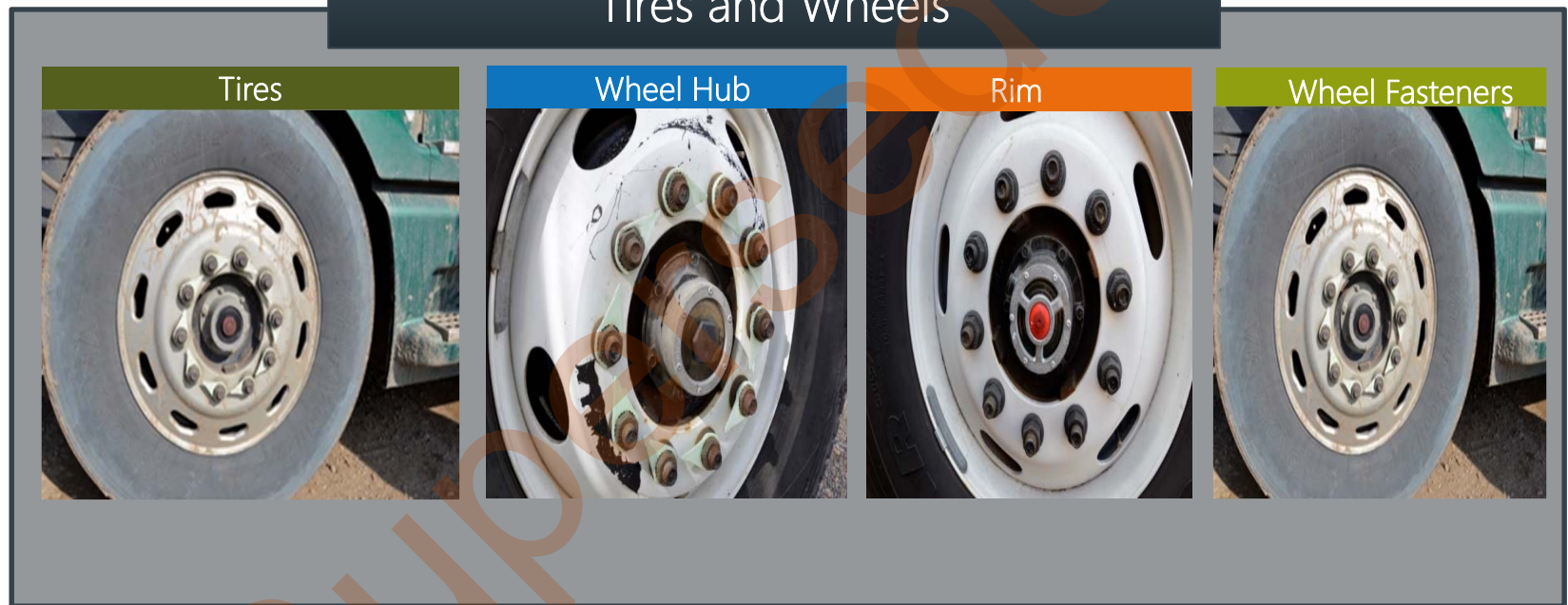

# Components and Systems in a Truck

## Coupling System

Fifth Wheel



Trailer Kingpin



Landing Gear



# Components and Systems in a Truck

## Gauges

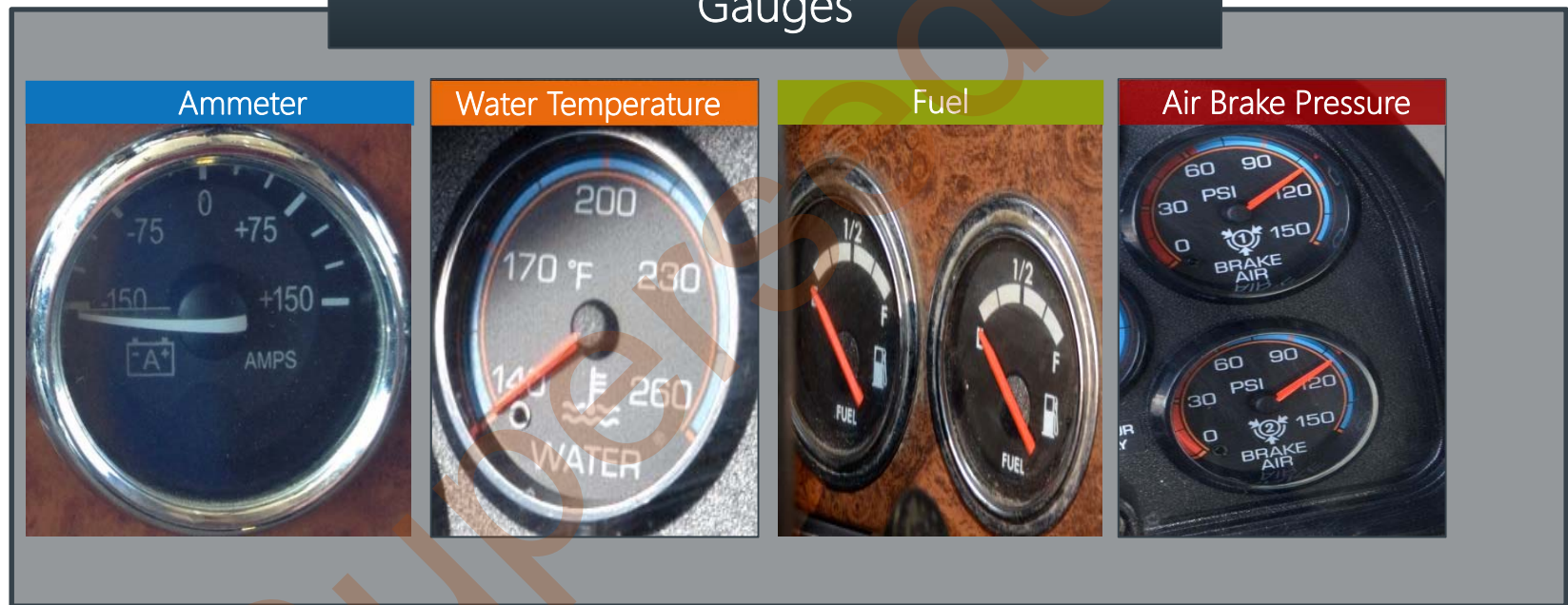



# Components and Systems in a Truck

## Gauges



# Components and Systems in a Truck

## Gauges (continued)



# Components and Systems in a Truck

## Gauges (continued)

Air Cleaner/Filter Restriction Indicator



Front and Rear Axle Temperature



Transmission Temperature



Diesel Exhaust Fluid (DEF)

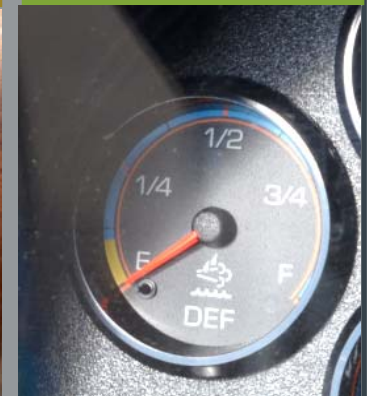

# Components and Systems in a Truck

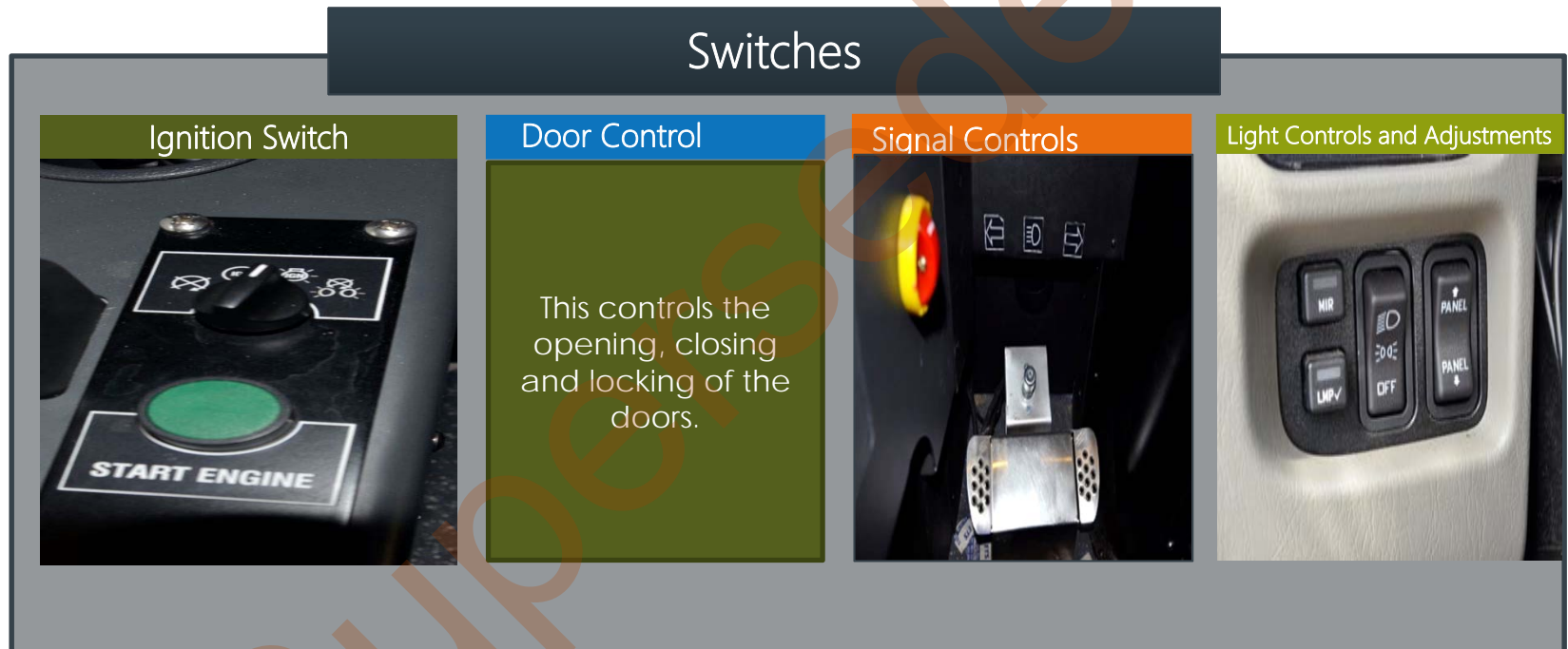

**Note:** The position of the components may vary with truck models



# Components and Systems in a Truck

## Stability Control System

- Assists drivers to remain in control of their vehicles by detecting loss of steering control.
- The system automatically applies the brake to offset oversteering or understeering.

# Components and Systems in a Truck

## Anti-Lock Brake System (ABS)

- Monitors and controls wheel slips during vehicle braking by minimizing lockup.
- Enables the driver to maintain steering control and to stop the vehicle in the shortest possible distance under most conditions.

# Warning Lights & Indicator Symbols



Oil Pressure

Low Oil Level

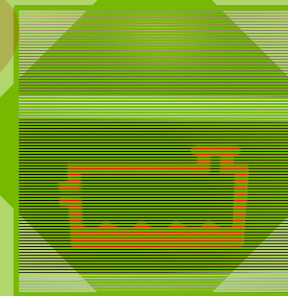

Low Coolant Level

Service Brake



# Warning Lights & Indicator Symbols

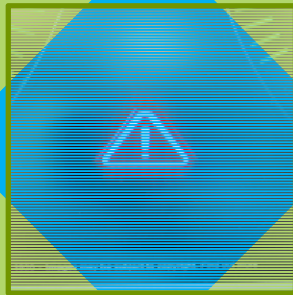

Alternator/Generator



Battery Light



Water Temperature



Low Fuel

# Warning Lights & Indicator Symbols



Anti-Lock Brake System  
(tractor)

Check Engine

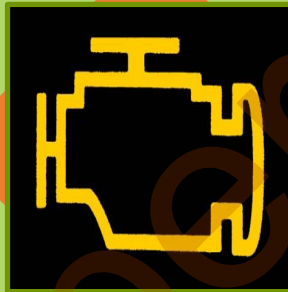

Park Brake

Fasten Seat Belt



# Warning Lights & Indicator Symbols

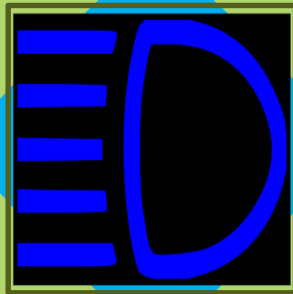

High Beams

Hazard Signal

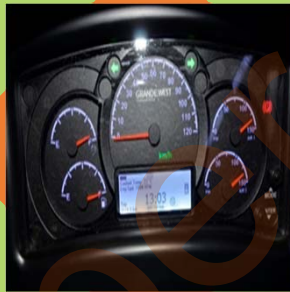

Left Turn Signal

Right Turn Signal



# Warning Lights & Indicator Symbols

Cruise control

High Exhaust System Temperature (HEST)

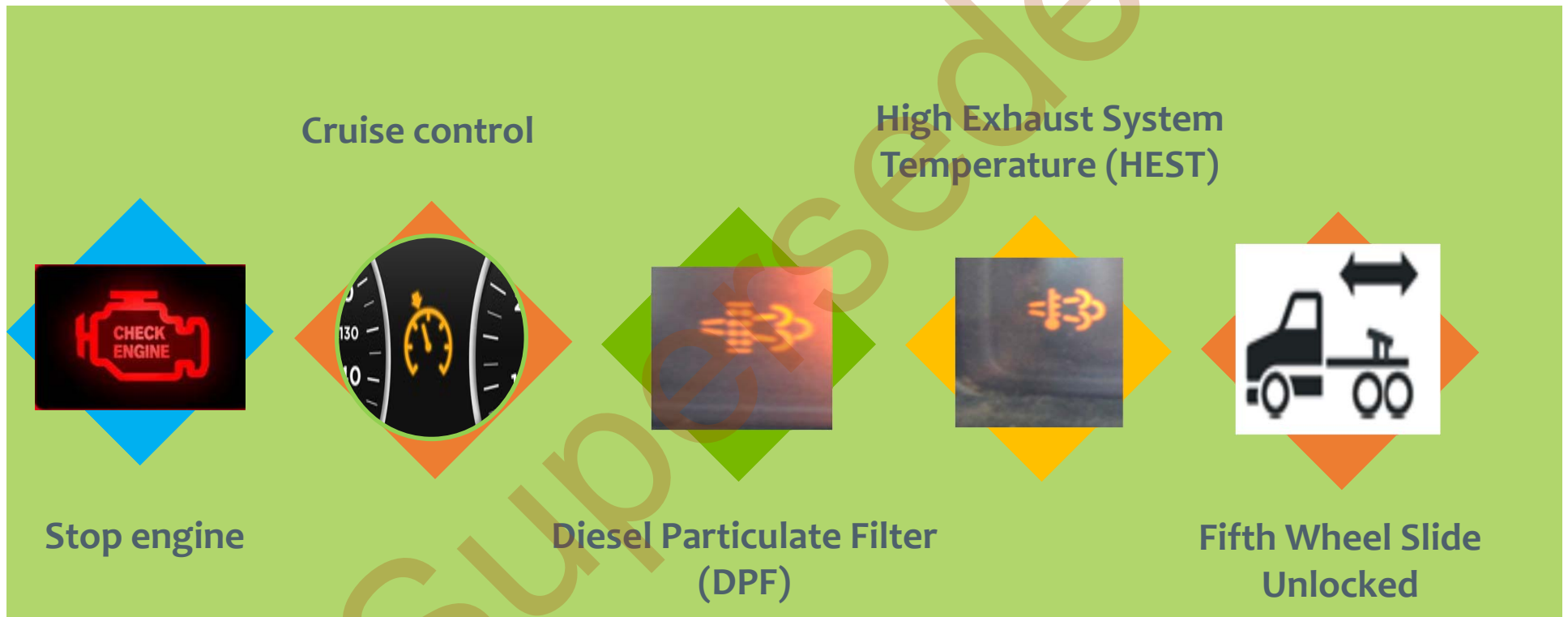

Stop engine

Diesel Particulate Filter (DPF)

Fifth Wheel Slide Unlocked

# In-Yard Evaluation Check list

1. Primary Vehicle Controls
2. Secondary Vehicle Controls
3. Engine
4. Lubrication system
5. Cooling system
6. Air intake/exhaust
7. Suspension system
8. Brake system
9. Auxiliary equipment
10. Electrical system
11. Vehicle body and frame
12. Tires and Wheels
13. Couplers and hitches
14. Gauges
15. Switches



## Conclusion

Knowing your vehicle and all of its features is a key part of being a safe, professional operator.

## Review

What are primary controls?

## Review - Answer

Main components that allow the driver to move and control the vehicle.

## Review

What are secondary controls?

## Review - Answer

Components that do not affect the movement of the vehicle but contribute to safety.

## Review

Why is the electrical system important?

Superseded

## Review- Answer

This system is important to start the engine, run the light or to utilize the vehicle instruments and gauges

## Review

Where can you find information to determine the optimal function of the vehicles components or systems?



# Review- Answer

The manufacturer's manual

Superseded

Alberta

## Review

What does the fuel filter do?

## Review- Answer

Keeps contaminants out of the fuel system by cleaning the fuel as it flows from the tank.

## Review

What is the power steering system?

## Review- Answer

The component of the engine that enhances easy movement of the steering wheel.

## Review

What is the landing gear used for?

## Review- Answer

Provides stationary support for the front of a trailer when it is not coupled to a tractor.

# Review

What is Electronic Stability Control?



## Review- Answer

A crash avoidance system that can detect and minimize skids by applying the brakes to offset over or under steering.

## Review

What does ABS stand for?

# Review- Answer

## Anti-lock Braking System

Superseded

## Review

What is the difference between a yellow and a red light on the dash?

## Review- Answer

Yellow is a warning to service soon.  
Red means there is something that needs to be serviced right now or before you take the vehicle out on the road.

# Questions?

---



Superseded

# Module 3 – Basic Driving Techniques

Superseded

# Purpose

## Module 3:

- ✓ Understand safe and effective tractor-trailer manoeuvring procedures.
- ✓ Recognize the importance of following all manoeuvring procedures in order to ensure safety
- ✓ Communicate the importance of journey management in ensuring a safe and low-stress trip.





## Proper Warm up Procedures

**A driver's first responsibility is to ensure that everything regarding their vehicle is in order.**

- It is important that you are fully alert and not impaired by anything that may affect your judgement
  - Complete an overall visual inspection of the truck.
  - Confirm valid Vehicle Inspection certificate/sticker.
  - Conduct the 'Under the Hood' portion of the pre-trip inspection.
-

# Section 1 - Start Up and Warm Up Procedures

## Entering and exiting the cab

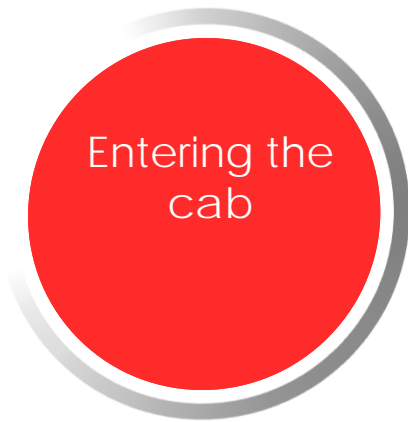

- Always check steps and handles for grease, fuel, oil, mud, ice.
- Clean off all residue before entering cab. Keep steps as clean as possible to eliminate slipping and injury.
- Wear appropriate footwear and high-visibility clothing
- Maintain a minimum of three points of contact.
- Focus on your entry, always facing the tractor.
- Place one foot on the step while keeping the other foot securely on the ground.
- Grip the handle on the inside of the door with one hand and the handle on the exterior cab frame with the other.
- Notice the three points of contact:

# Section 1 - Start Up and Warm Up Procedures

## Entering and exiting the cab



- Move your lower foot to the top step, pulling your body with your arms if necessary.
- There are still three points of contact.
- Bring your rear foot to the top step. Both feet are now on the top step so you may release one handle and still maintain three points of contact.
- Slide or step into the cab and release the remaining handle.
- You are now safely inside

# Section 1 - Start Up and Warm Up Procedures

Entering and exiting the cab



To exit the cab safely, use the following steps:

- Exit the truck by climbing out backward
- Maintain three points of contact at all times

**Never jump out of the cab!**

# Section 1 - Start Up and Warm Up Procedures

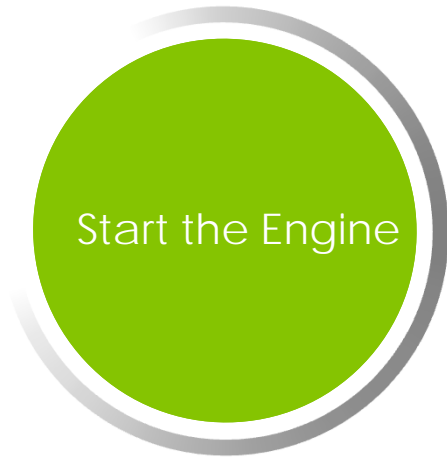

## Starting the Engine

### Manual Transmission

- Ensure parking brake is applied.
- Vehicle is in neutral position and the clutch is depressed.
- If the engine does not start, turn the starter off and try again in 60 seconds.
- If the unit is equipped with glow plugs, wait for the light to go out before starting the engine.
- Once the engine is on, proceed with the Interior and Exterior portion of the pre-trip inspection

# Section 1 - Start Up and Warm Up Procedures

## Engine Warm-up

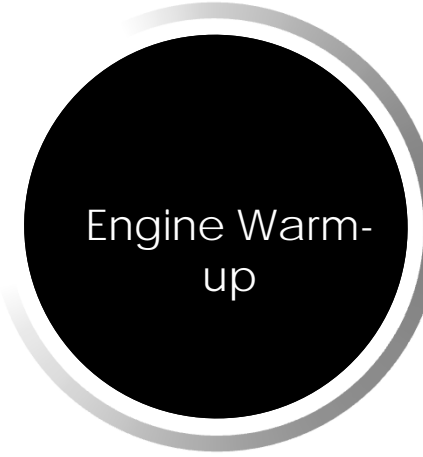

### Engine Warm-up

Engine warm up prepares the engine to do its job by:

- Circulating oil
- Lubricating parts
- Building pressure to proper levels.

# Section 1 - Start Up and Warm Up Procedures

## Documentation



Documentation

- Vehicle registration
- Insurance
- Safety Fitness Certificate (if applicable)
- Permits (if applicable)
- Hours of Service records (if applicable)
- Trip Inspection Report
- Bills of Lading (if applicable)
- Dangerous Goods shipping document /training certificate (if applicable)

# Section 1 - Start Up and Warm Up Procedures



## Seat Adjustment

### Correct Seat Adjustment

- Correct seat adjustment must be made before the vehicle is moved.
- This is essential for a safe vehicle operation.
- To maintain the greatest control, keep both hands on the steering wheel.



# Section 1 - Start Up and Warm Up Procedures

## Seat Belt Usage

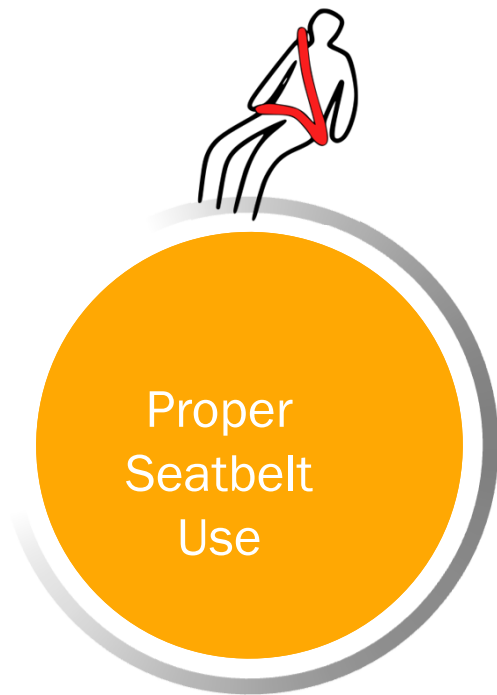

- Is the LAW
- Reduces chance of being killed or injured by 55 per cent if you are involved in a collision

# Section 1 - Start Up and Warm Up Procedures

## Mirror Adjustment



### Mirror Adjustment

- Correct mirror adjustments are essential for the safe operation of a commercial vehicle.
- Allow better view your blind spots (no zones) and "danger zone".

# Section 1 - Start Up and Warm Up Procedures

## Mirror Adjustment - Types of Mirror

### Convex Mirrors

- Located below the outside flat mirrors.
- Used to monitor the left and right sides at a wide angle.
- Provide a view of traffic and clearances at the side of the vehicle.

# Section 1 - Start Up and Warm Up Procedures

## Mirror Adjustment - Types of Mirror

### Flat Mirrors

- Mounted on the left and right at the front of the windshield.
- Used to monitor traffic and check clearances on the sides and to the rear of the vehicle.
- There is a blind spot immediately below and behind each mirror, directly in front of the vehicle, and directly in back of the rear bumper

# Section 1 - Start Up and Warm Up Procedures

## Mirror Adjustment - Types of Mirror

### Flat Mirror - Left side

Ensure that the left mirror is properly adjusted so you can see:

- 60 metres or four vehicle lengths behind the vehicle
- The top of the vehicle.
- A small portion of the sides of the vehicle.
- The rear tires touching the ground.

# Section 1 - Start Up and Warm Up Procedures

## Mirror Adjustment - Types of Mirror

### Flat Mirror - Right side

Adjust the right mirror so that the right side of the vehicle is visible along the left, inside edge of the mirror.

- The horizon line is seen three quarters of the way up the mirror.
- Both mirrors need to be adjusted the same way.
- Mirrors will not be helpful if they are not adjusted properly.

# Section 1 – Leaving the Driver’s Seat

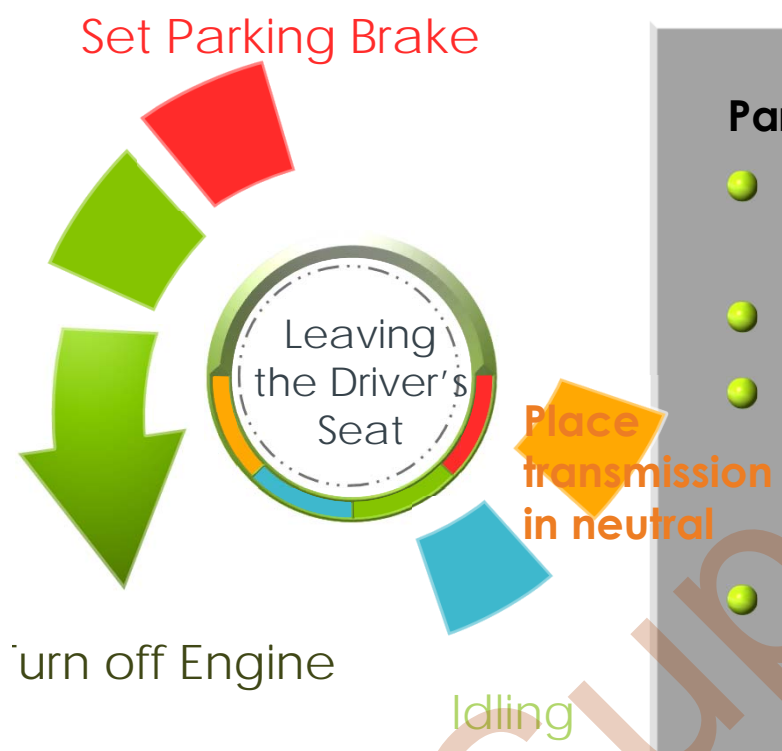

## Parking Brake

- The parking brake is set when the vehicle is to remain in position for some period of time.
- When the Driver is not at the controls.
- Turn off the engine to prevent idling.
  - Chock-blocks should be used in addition to the parking brake.
- Properly release the emergency brake by making a full application of the service brake before moving the truck.

# Section 1 – Leaving the Driver’s Seat



Set Parking Brake

Wheel Chocks

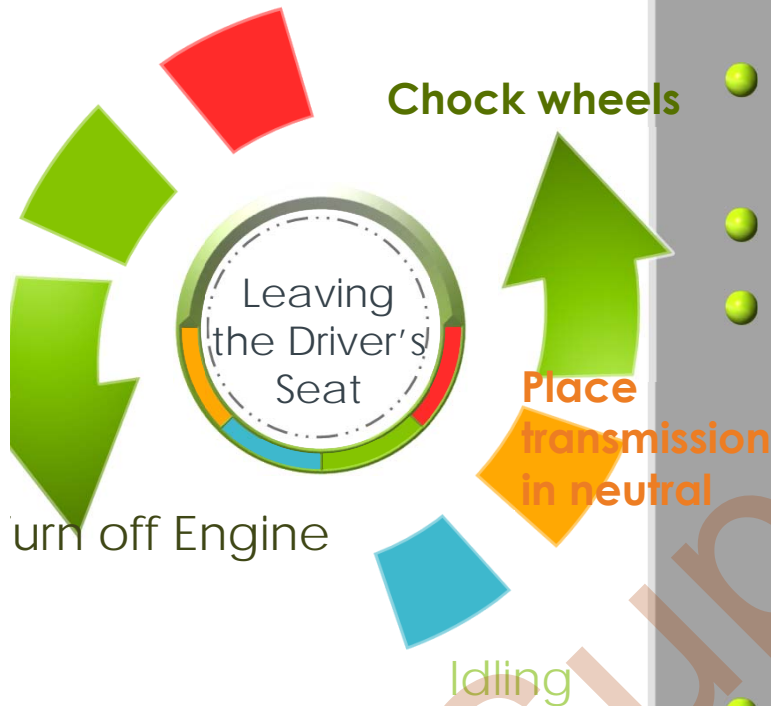

- Always ensure the chock is centered and squared with the tire.
- Always use wheel chocks in pairs.
- Wheel chocks must be positioned downhill and below the vehicle’s center of gravity.
  - On a downhill grade - in front of the front wheels.
  - On an uphill grade - behind the rear wheels.
- On a level grade - position the chocks on the front and back of a single wheel.



# Section 1 - Start Up and Warm Up Procedures

## Wheel Chock

### Tire size

- Smaller tires require smaller chocks, while larger tires require larger chocks.

### Gross vehicle weight

- Heavier vehicles require larger chocks than lighter vehicles.

### Level or grade of the ground surface

- Chocks need to be positioned in different ways.
- Ensure that the chocking configuration is correct based on surface grade is paramount for proper chocking.

# Section 1 - Start Up and Warm Up Procedures

## Wheel Chock

### Radial Tires vs. Bias-Ply Tires

- Radial tires by design deflect more than bias-ply tires.
- Allows the tire to wrap around the wheel chock which reduces the chocks effectiveness.
- Vehicles with radial tires should be chocked with larger wheel chocks.

### Tire pressure variance due to environment

- Improperly inflated tires can lead to chocking failures

### Condition of the ground

- Whether the ground is firm, soft, wet, dry, icy, or frozen is a key determination in the type of chock to use.

# Section 1 – Leaving the Driver’s Seat- Review

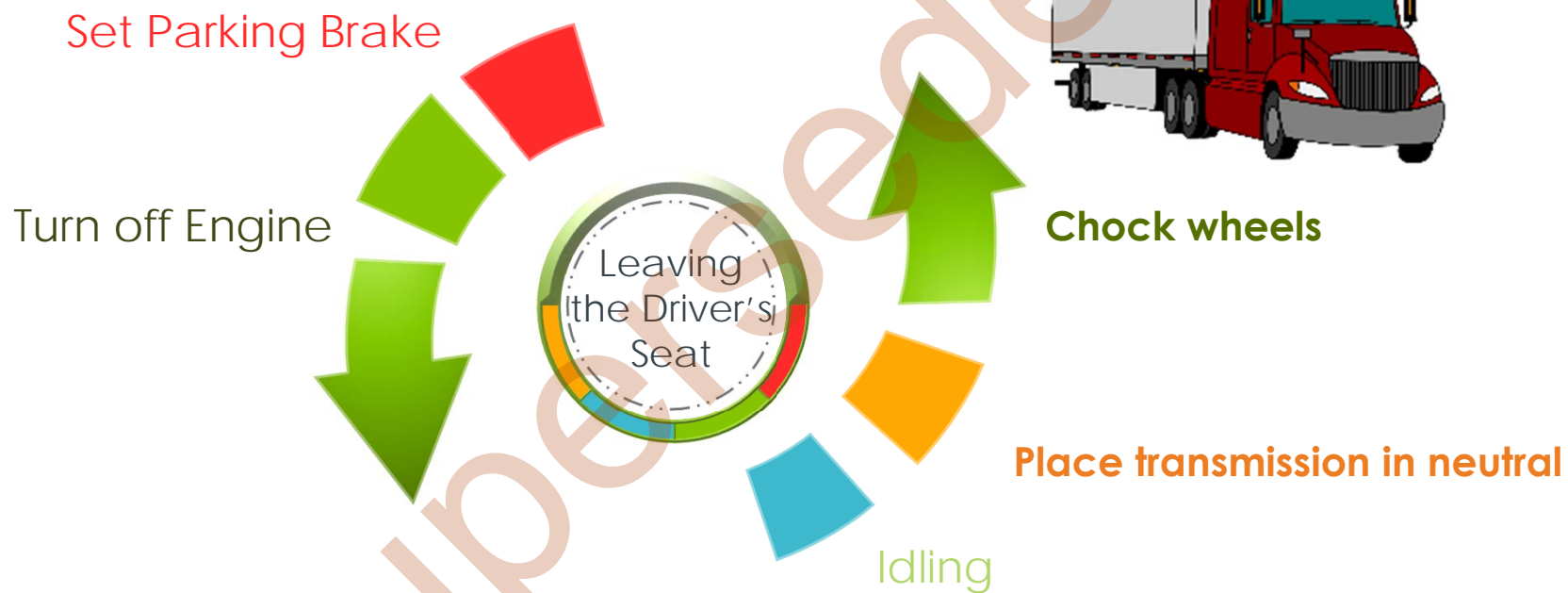

## Section 2 – Fuel Efficient Driving

### Smart driving practices

- ✓ Proper warming of the Vehicle
- ✓ Do not pump the accelerator when the vehicle is warming
- ✓ Use of cruise control
- ✓ Driving at average speed
- ✓ Smoothly changing of gears
- ✓ Run the engine in the highest gear range to keep it in a low rev range.

### Idling a truck

- Ten seconds of idling uses more fuel than restarting your engine.
- Engine oil life can be reduced by as much as 75% leading to more frequent and expensive oil changes.
- Engine wear is increased. One hour of idling is equivalent of 11 kilometres of driving

## Section 2 - Vehicle Size and Clearance



### Vehicle Size and Clearance

Having knowledge of your vehicle height, width and weight is important in ensuring smooth trip.

- Height
- Width
- Length
- Weight

# Railroad Crossings

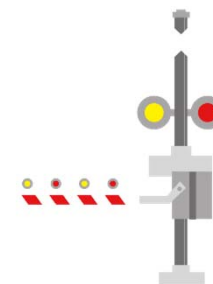
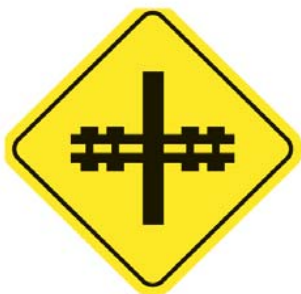
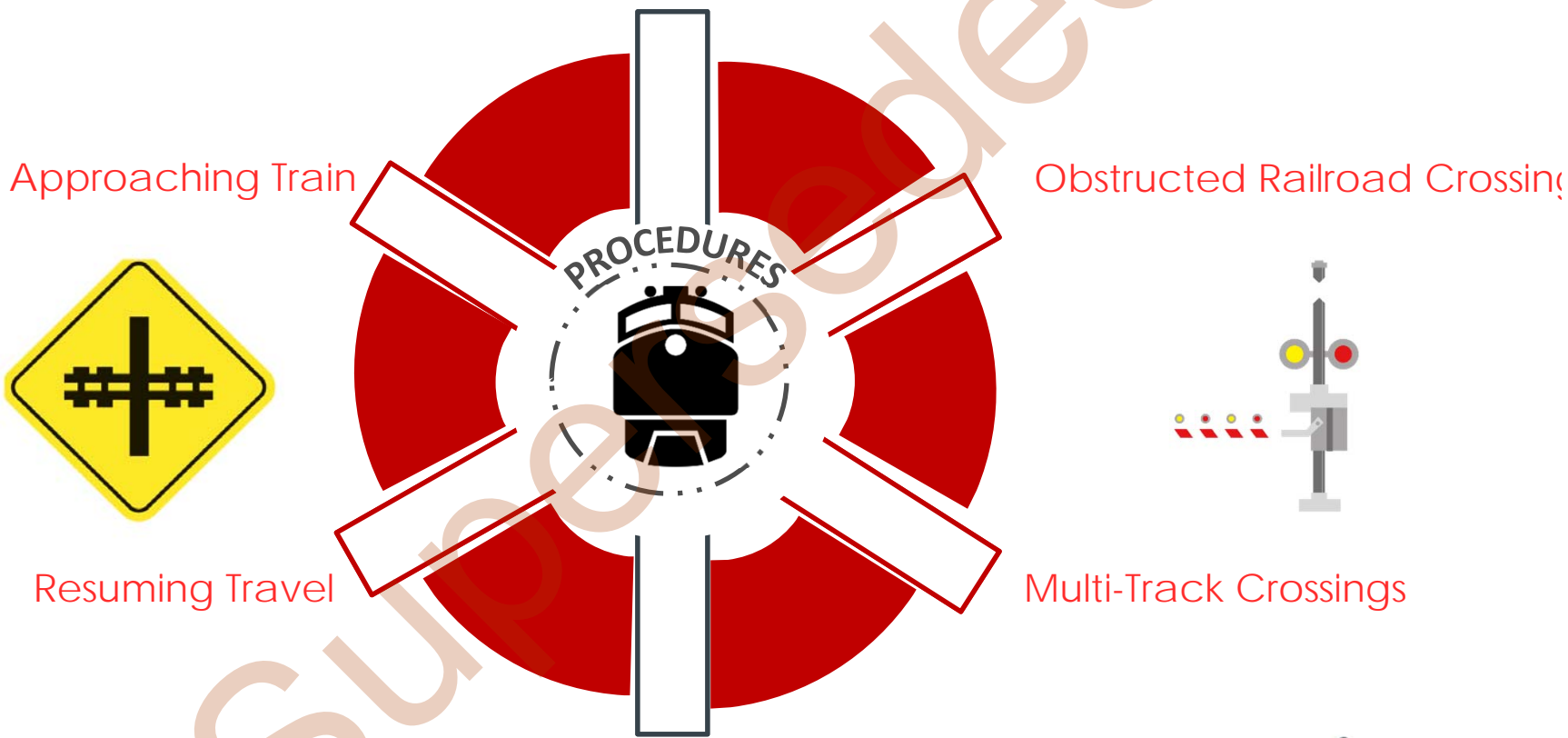

# Railroad Crossings

**Crossing railway tracks can be especially hazardous for drivers of large vehicles:**

- Longer vehicles need to travel further.
- Need more time to clear a crossing.
- Heavier vehicles take more time.
- Need more room to stop before a crossing.
- Larger vehicles are more likely to derail a train if there is a collision.

# Railroad Crossings

**Controlled crossing** - is one with a flag person, stop sign, crossing gate or an electric or mechanical signalling device



**Uncontrolled crossing** - Vehicles required by law to stop at all uncontrolled railway crossings are:

- School buses.
- Vehicles carrying explosives as a cargo or part of their cargo .
- Vehicles designated for carrying flammable liquids or gas, whether the vehicle is loaded or empty.





# Railroad Crossings

## Railroad Crossing Procedure when a Train is Approaching

- Slow down, shift to a lower gear.
- Test your brakes.
- Obey the traffic signs, signals, and gates.
- Check for traffic behind you and then stop.
- Stop no closer than 5 metres (about 16 feet) and no further than 15 metres (about 49 feet) from the nearest rail.
- Look carefully in each direction for approaching trains.
- Put on your park brakes.

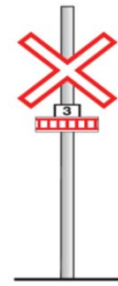

# Railroad Crossings

## Resuming Travel

- Make sure there is enough room on the other side of the track for the whole unit to clear, including the vehicle's overhang.
- Be aware that a train will be a metre wider than the rails on both sides.

# Railroad Crossings

## Other considerations

- Vehicle stalled or stuck on the tracks - get out of the vehicle immediately.
- Scan the tracks at a crossing - Do not attempt to cross the tracks unless you can see far enough in both directions to be sure that no train is approaching.
- Railway crossings at rural roads
  - Pay extra attention when you cross railway tracks in rural areas because why?

# Railroad Crossings

## 10 Tips to Save Your Life at a Railway Crossing

1. Be prepared to stop at all highway/railway crossings
2. Look for the cross-buck symbol of a highway/railway crossing.
3. Listen for warning bells and whistles.
4. Always obey the signals.
5. If a police officer or railway personnel are directing traffic at the crossing, obey their directions.
6. If one train passes, make sure that a second train isn't approaching on another track.

## Railroad Crossings

7. Cross the tracks in low gear. Never attempt to change gears while crossing.
8. If your vehicle stalls on the tracks, get out quickly and away from the vehicle and the tracks.
9. If your view is obstructed for 300 metres in either direction, do not attempt to cross the tracks until you are certain that no train is approaching.
10. Walking or playing on train tracks is extremely dangerous and illegal.

# Railroad Crossings

**What are some common driver errors at railway crossings?**

# Traffic Signals

## Traffic control signals

- Are lights that use the colors green, yellow and red to control.
- The color of the light determines which stream of traffic has the right of way.
- The traffic control signal may be vertical or horizontal.



*The order of lights for a vertical traffic control signal is red at the top, yellow in the centre, and green at the bottom.*



*The order of lights for a horizontal traffic control signal is red on the left, yellow in the centre, and green on the right.*

## Traffic Signals

### Solid Red Light

- Make a complete stop before the stop line or crosswalk that is directly in front of the vehicle.
- If there is no stop line or crosswalk, you must stop before the intersection.
- The truck must remain stopped at the red light until it turns green, unless safely turning right after stopping.



# Traffic Signals

## Solid Yellow Light

- It warns that the light will change to red immediately and drivers must prepare to stop or clear the intersection.
- When you are already in the intersection and facing a yellow light, you must safely clear the intersection.

# Traffic Signals

## Solid Green

- You are permitted to travel through the intersection without stopping, unless required to yield to oncoming traffic when turning left or to pedestrians in the crosswalk when turning right or left.
- When you are approaching a green light, anticipate that it will turn yellow.

# Awareness on the Road

## Vehicle Behaviour

Monitoring your vehicle's behaviour while driving will help prevent encountering dangerous and costly mechanical breakdowns.

- Brakes
- Transmission
- Clutch
- Engine
- Steering
- Suspension

# Awareness on the Road

## Manner of Driving

- Forward Driving
- Other Vehicles
- Pedestrians
- Cyclists

Superseded

# Shifting Gears, Accelerating and Decelerating

- A skilled driver can utilize a combination of transmission and engine retarder to slow their vehicle while only using their brake at the last moment to come to a complete stop
- The objective is to try to minimize speed changes by being in harmony with the traffic tempo and, in urban areas, in sync with traffic lights.

# Shifting Gears

## Standard Transmission

- Check for the gear pattern.
- Depress the clutch pedal and turn the ignition on.
- Shift into the appropriate gear.
- Depress the foot brake.
- Release the park brake.
- Release the clutch to the friction point.
- Remove foot from the brake pedal, and accelerate gradually.

## Shifting Gears (cont.)

- Remove your foot from the clutch slowly completely and place it on the floor while continuing to accelerate.
- Do not ride the clutch!
- Accelerate the tractor-trailer to the proper engine speed before attempting to shift .
- When appropriate to shift gears, first depress the clutch pedal and release accelerator at the same time.
- Shift into the next gear.
- Smoothly release the clutch and continue to accelerate gradually.

# Downshifting

**When downshifting from cruising speed, reduce speed, then:**

- Depress the clutch and release the accelerator.
- Shift to the next lower gear.
- Release the clutch smoothly and use the accelerator to provide engine power appropriate to the terrain you are travelling on.
- Repeat these steps to continue downshifting as the proper engine speeds are reached.



# Downshifting

- To bring the tractor-trailer to a complete stop apply the brake.
- Gradually increasing pressure, and depress the clutch after reducing speed to between 8-16 km/h.
- If you are parking the tractor-trailer to leave it: set the parking brake
- Follow the shutdown procedures, select the appropriate gear, and secure the truck.

## Double Clutching

- Depress the clutch pedal just past the friction point.
- Release it and depress it again while shifting gears.
- Double-clutching lets you speed up or slow down the input shaft while it's in neutral and not engaged to any gear.

# Double Clutching

## Upshifting by Double Clutching

1. Depress clutch pedal and release accelerator simultaneously.
2. Shift gear lever to neutral position.
3. Release clutch pedal momentarily.
4. Depress clutch pedal and shift to next higher gear.
5. Release clutch pedal and accelerate engine at the same time.

# Double Clutching

## Downshift by Double Clutching

1. Depress the clutch pedal.
2. Move the gearshift lever into neutral.
3. Release the clutch pedal.
4. Accelerate the engine speed until engine rpm and road speed "match".
5. Depress the clutch pedal and quickly move the gearshift lever to the next gear position. (Do not engage the clutch brake)
6. Release the clutch pedal and press the accelerator at the same time.

# Section 3 - Basic Driving Techniques

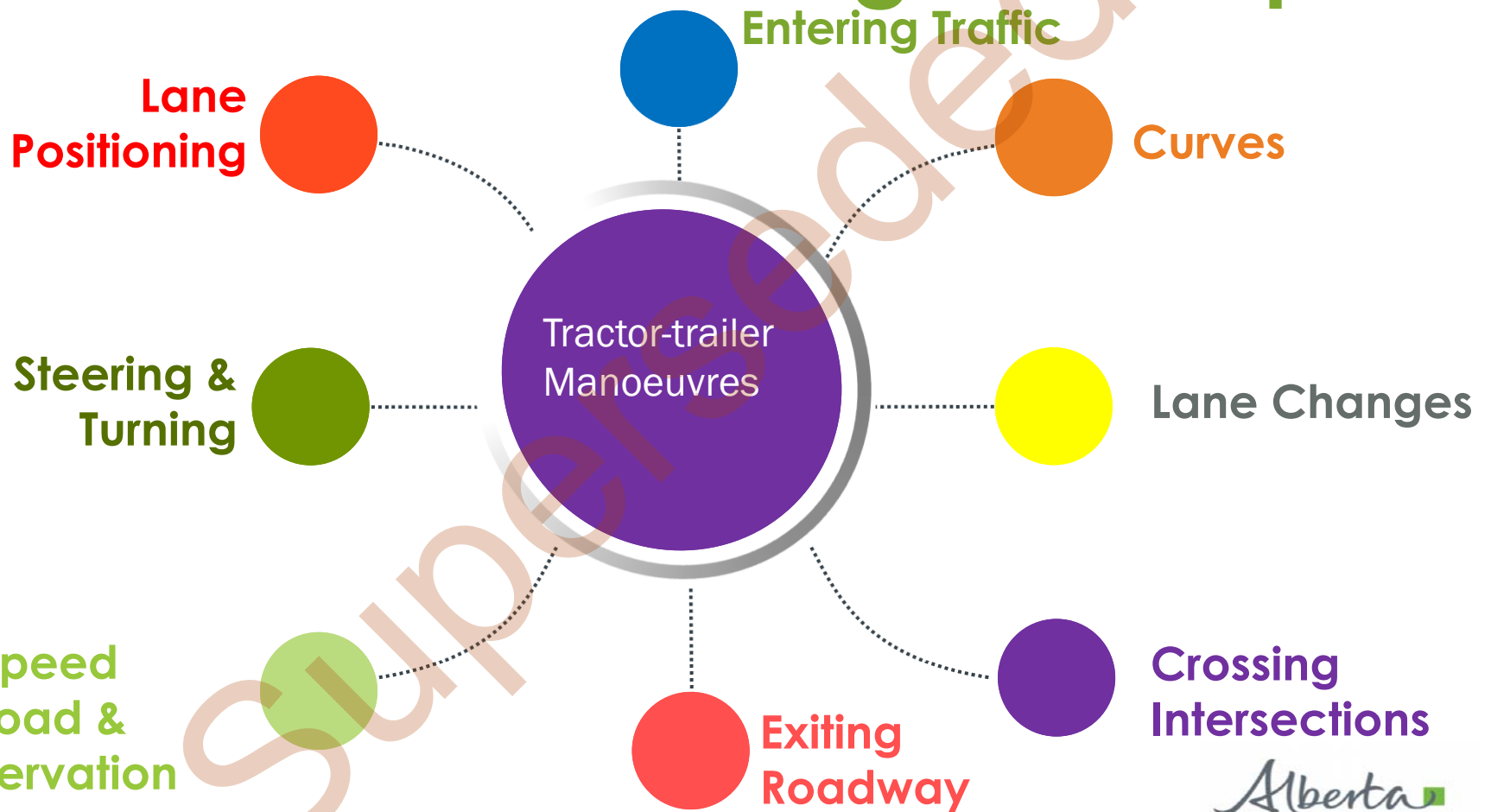

# Tractor Trailer Maneuvers

- Entering Traffic/Merging
- Exiting a Major Roadway
- Weave Zones
- Lane Positioning
  - Off-Tracking
- Steering and Turning
- Driving long a curve
- Crossing intersections
- Observation techniques and monitoring of road conditions

# Tractor Trailer Maneuvers

## Entering Traffic/Merging



- Merging is a shared responsibility between the vehicles joining the roadway and the vehicles already on the roadway.
- Signal at least four flashes in advance
- Check mirrors and windows to ensure clear path
- When merging from an alley, side street, driveway or terminal come to a complete stop before entering a cross street and remain in the lane nearest to the curb until reaching appropriate speed
- When entering highways, freeways or other restricted access roads stay in the right lane until matching the speed of other traffic

# Tractor Trailer Maneuvers

## Lane Positioning

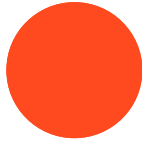

- Position vehicle within the centre of the lane
- Keep proper space cushion around pedestrians and other vehicles
- On a multiple lane highway, always maintain a minimum four second following distance.
- Once you are in the desired lane, cancel turn signal after completion

Superseded



# Tractor Trailer Maneuvers

## Off-tracking

- Low speed off-tracking -In low or moderate speed turns, the rear tires are pulled inward of the steering path
- High speed Off-tracking - is the effect of centrifugal (outward) force
  - It is seen when a vehicle travels at higher speeds, and the rear tires pull outward from the steering path during a turn

# Tractor Trailer Maneuvers

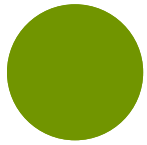

## Steering and Turning

### Steering

- Hand-over-hand steering method is the best to use
- One hand pushes the steering wheel up, across and down, while the other hand reaches up to the top of the wheel and pulls down



Supervised

# Tractor Trailer Maneuvers

## Making Turns

- Signal and mirror check.
- Reduce speed and downshift to the proper gear.
- Check for clear right-of-way.
- Be aware of other road users.
- Execute the turn.

# Tractor Trailer Maneuvers

## Left Turns

- Avoid if possible as they are high risk manoeuvres. When required, make sure you follow the steps below:
  - If not in the legal turning lane, mirror and shoulder check.
  - Reduce your speed one half-block back.
  - Ensure that you shift into a proper gear for the turn.
  - Signal left at least one third of a block (30 meters) from the intersection.

# Tractor Trailer Maneuvers

## Left Turns

- Scan the intersection for traffic control devices.
- Check left, center, right and left again for traffic and pedestrians.
- Travel straight into the intersection to within approximately 3 meters.
- Keep front wheels straight and yield to approaching traffic and/or pedestrians.

# Tractor Trailer Maneuvers

## Left Turns

- Look well along the intended lane of travel, accelerate, and begin the turn when safe to do so.
- Stay only as far to the right side as necessary to avoid the rear wheels running over obstacles or other vehicles.
- Start to recover steering by using the hand-over-hand method.
- Accelerate, cancel the turn signal and look up at least 12 seconds ahead or one block ahead.

# Tractor Trailer Maneuvers

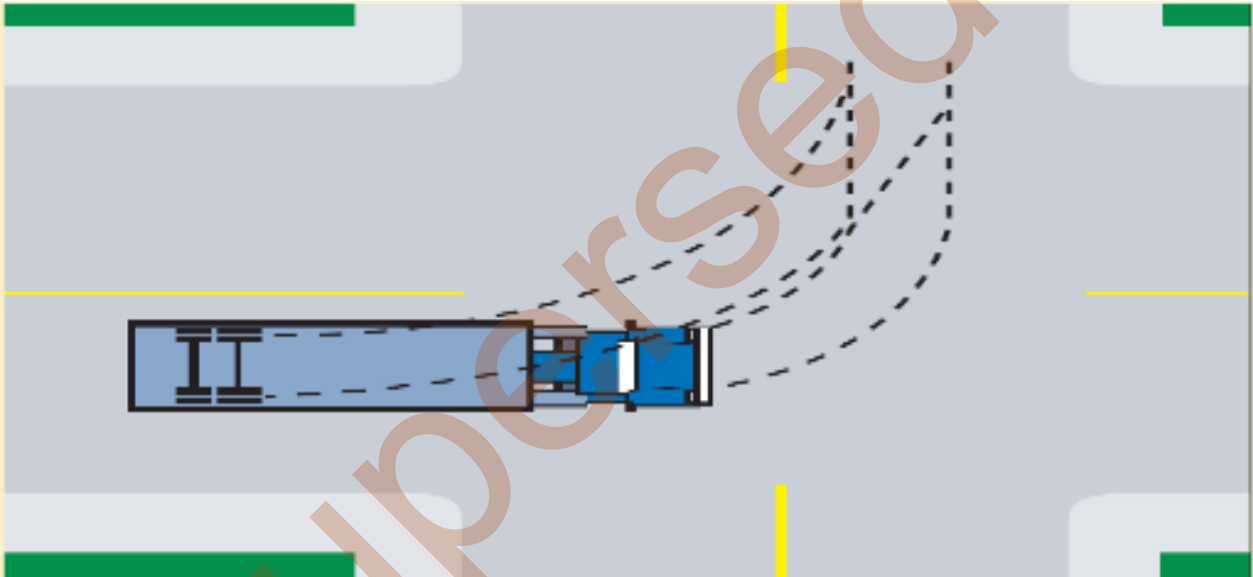

Left Turns

# Tractor Trailer Maneuvers

## Right Turns

- Take the right-most lane available.
- Signal to the right.
- Scan the intersection for traffic control devices.
- Check left mirror for vehicles attempting to pass.
- Check if the intended lane of travel is free.
- Check left, center, right for traffic and pedestrians.
- Proceed with the turning procedure using hand over hand steering.



# Tractor Trailer Maneuvers

## Right Turns

- Be aware that you might need to go over the centre line of the street you are entering or into the second traffic lane.
- Return to curb lane immediately after the rear wheels clear the curb.
- Maintain a safe and controlled speed.
- Look well up the driving path at least one block.
- Accelerating as necessary.

# Tractor Trailer Maneuvers

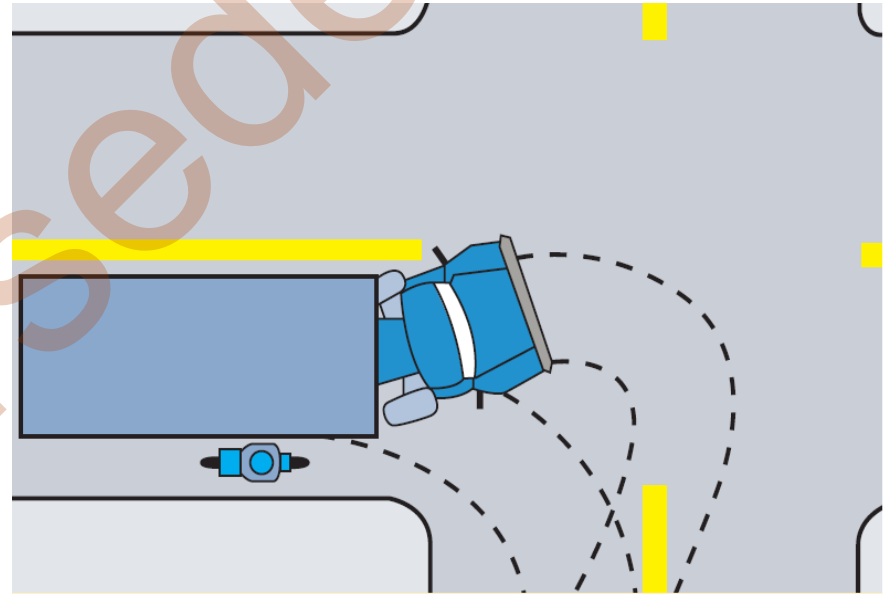
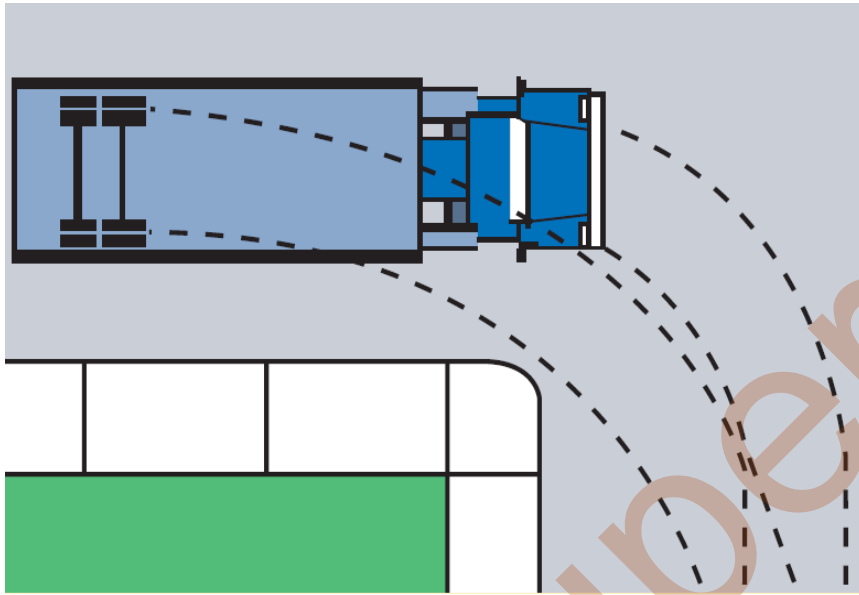

# Tractor Trailer Maneuvers



## Curves

- When large vehicles enter a curve the rear wheels do not follow the same path as the front because they do not pivot;
- The rear wheel will “off-track” closer to the curb than the front wheels.
- To mitigate this off-tracking, you must lead your turning arc of the front wheels according to how sharp the curve is and the vehicle’s off-track.

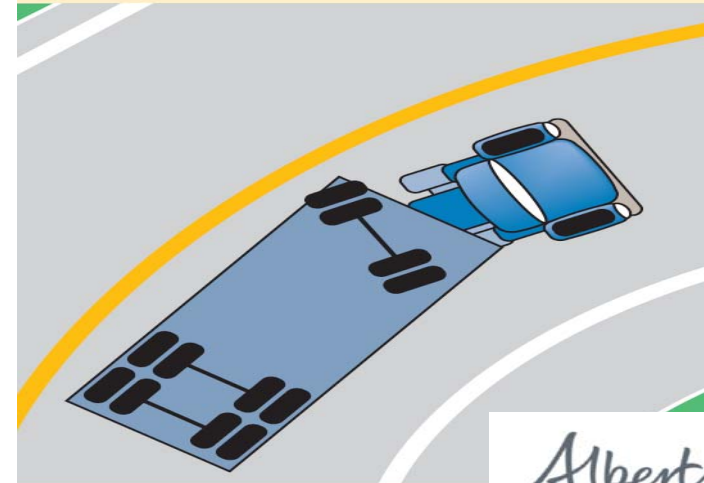
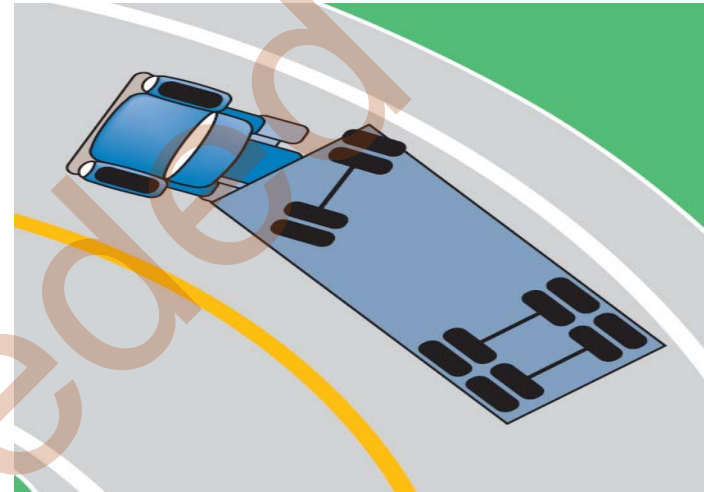

Alberta

# Tractor Trailer Maneuvers

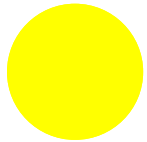

## Lane Changes

- Only change lanes when necessary.
- Always check for clearance by looking out of the windows.
- Use both mirrors to be sure that there are no vehicles beside or behind the truck.

# Tractor Trailer Maneuvers

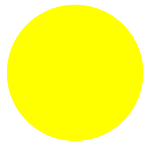

## Lane Changes

- Give special consideration for the speed vehicles are travelling behind you to ensure they will not overtake you once the lane change has begun.
- Always signal intent with at least four flashes of the turn signal before beginning the lane change.
- If the lane change involves passing another vehicle, when on a multiple lane highway, always maintain a minimum four second following distance.

# Tractor Trailer Maneuvers

## Negotiating Intersections

- **KNOW**
  - Expect the unexpected.
- **SHOW**
  - Communicate with other drivers.
- **GO**
  - Proceed with caution.

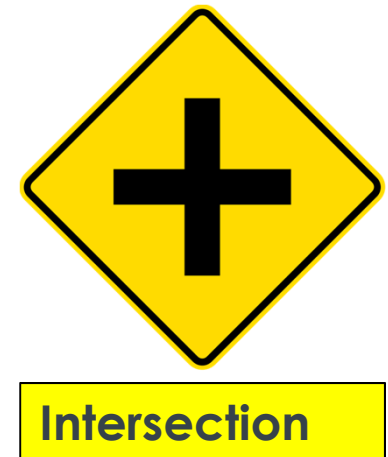

**At all intersections**

**Never** assume the other driver will yield to you!

Alberta

# Tractor Trailer Maneuvers

## Crossing Intersections

- Depending on visibility, take your foot off the accelerator, check mirrors, check left then right for traffic indicators and controls, pedestrians and other vehicles, then proceed through the intersection when safe.
- Scan the area to determine the point-of-no-return;
  - Speed of the vehicle.
  - Road conditions.
  - Traffic volume to the front, rear and side.
  - Visibility.



*T intersection*

— Alberta

# Tractor Trailer Maneuvers

## Crossing Intersections

- Watch for traffic changing lanes or entering your lane from alleys or driveways.
- Once past the intersection check mirrors again for any change in traffic patterns behind you.
- If you plan to turn at the next intersection, position yourself so you are ready to turn.
- Look for pedestrians that may be crossing ahead.
- With any intersection, if your visibility is obstructed for any reason, you may be required to stop prior to proceeding.

Alberta



# Mountain Driving and Grades

## Driving Up Grades

- Move to the right and maintain a safe speed.
- When shifting becomes necessary, shift one shift range at a time to maintain a safe speed.
- Observe the engine temperature more frequently under these conditions to detect dragging, pulling and overheating
- **Never** pass a vehicle on a downgrade or an upgrade on a two lane highway.

# Mountain Driving and Grades

## Driving Down Grades

- Before proceeding down a grade, check the system air pressure and cover the brake.
- Select the appropriate gear to descend the hill, this is usually a lower gear than required to go up the hill.
- Stay to the right while proceeding down the grade, maintaining a safe vehicle speed as required to be in control without overheating the brakes or depleting the air pressure.

# Mountain Driving and Grades

## Snub Method Downhill Braking

- Apply the brakes hard enough to feel a definite slowdown.
- When speed has dropped to 5 KPH below safe or posted speed, release the brakes.
- When speed increases above the safe or posted speed, repeat the first two (2) steps.



*Hill*

# Mountain Driving and Grades

## Stopping and Parking on Hills

- Check for following traffic using side mirrors and signal to pull over to the curb or edge of the road.
- Downshift, if necessary, to reduce speed in preparation to stop.
- Apply brakes lightly at first and then apply firm, even pressure for a smooth stop.

# Stopping and Parking on Hills

- Depress the clutch as you are near a stop
- Shift to low gear.
- Allow extra room between vehicles for safety.
- Turn wheels into the curb on a downgrade.
- Away from curb on an upgrade.
- Ensure front tire makes gentle contact with the curb.
- For parking downhill, with or without a curb, the front wheels should always be turned to the right.
- For parking uphill with a curb, the front wheels should always be turned to the left.
- For parking uphill without a curb, tractor-trailer units with one articulation point should always have the front wheels turned to the left.
- Set the park brake and turn off the ignition.

# Stopping and Parking on Hills

## Starting on a Hill

- When stopped on a hill the parking brake should already be engaged.
- Depress the clutch and shift into the appropriate gear.
- Release the parking brake.
- Release the clutch slowly to the friction point while gradually depressing the accelerator.

# Tractor Trailer Maneuvers



## Exiting Roadway

### Tips on How to Exit a major Roadway or Highway Safely

- Plan ahead
- Turn on signal well in advance
- Move into deceleration lane as soon as possible
- Use the deceleration lane as much as possible to slow the vehicle down
- If you miss your exit continue to next exit. Do not stop or reverse on a roadway

Superseded

# Tractor Trailer Maneuvers

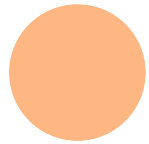

## Weave Zones

- **Weave zones** are places where the highway entrance and exit use the same lane
- Be courteous with other vehicles merging in or exiting
- Control the speed and timing of your lane change with traffic

Superseded





# Summary

- When stopping for a train at a railroad crossing, tractor-trailer can be brought to a stop no closer than 5 metres from the nearest track(s) and no further than 15 metres.
- Keep the wheels pointed straight ahead when making a left turn so you are not pushed into oncoming traffic, if struck from behind.
- Looking ahead 12 seconds down the road and maintaining a four second following distance between vehicles gives you the necessary space to react to unexpected situations.
- Do not enter an intersection or rail crossing unless you can clear it completely.

## Review

Whose responsibility is it to ensure everything regarding the vehicle is in proper working order?

# Review

## THE DRIVER

Superseded

Alberta

## Review

To prevent falls or injuries driver's must maintain \_\_\_\_\_ contact when entering or exiting the cab.

# Review

3-Point

Superseded

Alberta

## Review

You should never \_\_\_\_\_ out of the cab.

Superseded

# Review

Jump

Superseded

## Review

Engine warm up prepares the engine to do its job by:

Superseded



## Review

Circulating oil, lubricating parts and building pressure to proper levels.

## Review

True or False – A driver is required to carry the vehicle registration for both the truck and trailer?

# Review

TRUE

Superseded

Alberta 

## Review

Proper mirror adjustments allow for what?

Superseded

## Review

Better view of the “no zones”  
and “danger zones”.

## Review

Where would you place the wheel chocks on an uphill grade?

Superseded



# Review

## Behind the rear wheels

Superseded

## Review

Railway crossings can be especially hazardous for large vehicles, what should you avoid on a railway crossing?



# Review

## Shifting Gears

Superseded

# Review

What is a controlled intersection?

Superseded

# Review

Where there is traffic signals, signs or a police officer directing traffic.

# Practical Guide

## Objectives of the On-road Practical

- Gain an adequate level of skill, knowledge, attitude and vehicle control.
- To provide trainees with the knowledge and skills required to apply driving laws, proactive driving practices, hazard detection and defensive driving techniques to ensure cooperative, safe and legal operation of a motor vehicle.
- To gain confidence to drive independent.

## Practical Guide

Upon entering a vehicle: point out the location and explain the function of each of the following controls:

- Hazard light switch
- Park brake
- Headlight switch
- Dimmer switch
- Windshield washer and wiper controls
- Defroster switch
- Speedometer

# Practical Guide

Prior to moving the vehicle apply the following basic steps:

- Ensure **parking brakes** are applied.
- Remove **wheel chocks**.
- Check **seats and mirrors** for proper adjustment.
- Attach and properly adjust **seatbelts**.

## Practical Guide

- Depress **clutch** and ensure **transmission** is in neutral prior to starting engine.
- Start **engine**.
- Verify that the air compressor functions properly.
- Select proper **gear** and release **parking brakes** when ready to leave.

## Lesson A: Basic Driving Maneuvers

- Smoothly start the vehicle
- Apply continual observation techniques and monitoring of road conditions
- Conduct regular traffic checks
- Monitor vehicle blind spots and proper use of mirror
- Drive courteously, manages unexpected situations, manages distractions and drives within capabilities and experience.



## Lesson A: Basic Driving Maneuvers

- Monitor vehicle behavior and operating conditions
- Recognize their responsibilities for sharing the road.
- Manage speed and following distance.
- Maintain proper road and lane position
- Observe road signs and pavement markings.
- Integrate with traffic and show awareness of other road users.
- Operate vehicle controls smoothly
- Maintain two-handed grip on the steering wheel
- Select gears correctly and shift smoothly
- Smoothly stop the vehicle at the end of this task

## Lesson B: Driving through the Curves

- Prepare for the curve as it becomes visible by completing the following steps:
  - a) Conduct a visual assessment.
  - b) Conduct a signage check.
  - c) Conduct a pavement marking check.
  - d) Conduct a traffic check.
  - e) Adjust speed as required.

## Lesson B: Driving through the Curves

- Travel through the curve by completing the following steps:
  - a) Manage speed and following distance.
  - b) Steer through the curve following a proper path, based on vehicle off-tracking and clearance requirements.
  - c) Conduct a traffic check.
  - d) Maintain two-handed grip on the steering wheel as much as practicable.

## Lesson C: Practicing Lane Changing

- Prepare for the lane change by completing the following steps:
  - a) Conduct a traffic check.
  - b) Conduct a pavement marking check.
  - c) Manage speed and following distance.
  - d) Activate turn signal correctly and on time.
  - e) Mirror check one more time.

## Lesson C: Practicing Lane Changing

- Execute the lane change by completing the following steps:
  - a) Steer vehicle into the correct position in the new lane.
  - b) Manage speed and following.
  - c) Cancel turn signal within about 5 seconds after completion.

## Lesson D: Crossing Intersections

Prepare for crossing the intersection as it becomes visible by completing the steps:

- Approach the boundary of the intersection while completing the steps.
- Stop at an intersection when required by completing the steps.
- Proceed across the intersection after stopping, or when no stop is necessary, by completing the steps.

## Lesson E: Turning at Intersections

- Select the correct lane for starting the turn.
- Activate turn signal correctly and on time.
- Conduct a continuous traffic check while turning.
- Manage speed and following distance.
- Interpret right-of-way obligations correctly.
- Steer through the intersection following a proper path.
- Select the correct lane for travel after the turn.
- Cancel turn signal after completion.

# Lesson F: Entering and Exiting a Highway

## Before entering a highway:

- Conduct a traffic check.
- Manage vehicle speed according to conditions.
- Conduct a pavement marking check and stay within markings.
- Change lanes or merge as necessary on the ramp.
- Negotiate the ramp at appropriate speed.
- Manage following distance.



## Lesson F: Entering and Exiting a Highway

- Activate turn signal correctly and on time.
- Adjust vehicle speed within the acceleration ramp to facilitate merge into traffic.
- Interpret right-of-way obligations correctly.
- Merge onto highway maintaining suitable distance from other vehicles and adjusting speed as needed, responding to metered ramp entry systems where applicable.
- Cancel turn signal after merge is complete (never keep signal on more than 5 seconds)

# Lesson F: Entering and Exiting a Highway

## Before exiting a highway:

- Conduct a traffic check.
- Manage following distance.
- Change lanes if necessary well before the exit.
- Reduce speed as appropriate .
- Activate turn signal correctly and on time.
- Conduct a pavement marking check and stay within markings.

## Lesson F: Entering and Exiting a Highway

- Drive onto exit ramp as soon as space is available.
- Decelerate as necessary within deceleration ramp.
- Manage vehicle speed according to conditions and posted advisories.
- Negotiate the ramp at appropriate speed and change lanes or merge as necessary.
- Cancel turn signal after getting fully into exit lane.

# Practical Assessment

## The assessment guidelines:

- A. Controls - This involves knowledge and use of vehicle components.
- B. Starting and Stopping- this covers all situations where the driver is putting the vehicle in motion, either forward or in reverse.
- C. Main Driving - This includes maneuvers between intersections such as safe lane changes, planned driving, speed, and vehicle control.

## Practical Assessment

- D. Turns - Relates to proper procedures for completing turns.
- E. Intersections - This includes observation of conditions, speed, compliance with traffic control devices, right of way judgements, and vehicle control.
- F. Traffic light and signs – this involves observing and obeying traffic lights and signs.
- G. Hill Park.

# Practical Assessment

## A. Controls

- Gears
- Steering
- Clutch
- Acceleration
- Braking

Superseded



# Practical Assessment

## B. Starting and Stopping

- Check for traffic
- Signaling
- Crosswalks
- Curbs
- Clutch friction control

Superseded



# Practical Assessment

## C. Main Driving

- Planned Driving
- Road Position
- Observation
- Signals
- Speed
- Vehicle Controls



# Practical Assessment

## D. Turns

- Signals
- Lanes
- Cuts Corners/Turns Wide
- Incorrect Position
- Vehicle Controls

Superseded



# Practical Assessment

## E. Intersections

- Approach too fast
- Fail to observe conditions
- Traffic control devices
- Entering highway
- Right of way judgement
- Vehicle position

# Practical Assessment

## F. Traffic Lights And Signs

- Fails to anticipate traffic light or signs.
- Fails to obey traffic light and signs.

## G. Hill Park

- Tire
- Position
- Brake/Gear
- Control

# Practical Assessment

## Terminating an On-road practice

- Some situations may warrant an immediate termination of the practice
- Operating a tractor unit is serious business.
- Safety is paramount, and trumps all other concerns.
- If the vehicle, conditions or the operator are not fit, then the drive will not happen.

## Practical Assessment Summary

**The instructor will summarize the trainee's driving ability at the end of each lesson by:**

- Explaining and identifying weak areas and provide options to improve.
- Providing an overall assessment of the trainee's progress, identifying areas of success and areas requiring more attention.
- Provide recommendations for further practice.
- Providing feedback and complete the assessment form.
- Assigning a final grade for the in-vehicle portion of this module.

# Questions?

---



Supersedes

# Module 4 – Professional Driving Habits

Superseded

# Purpose

## Module 4:

- ✓ Understand the concept of Defensive Driving
- ✓ Understand that personal attitudes and defensive driving habits are key to preventing collisions.
- ✓ Link Defensive Driving with Visual Search Patterns, Timing, the IPDE process and the 6 Basic Conditions.
- ✓ In-depth discussion about the types of impairments and impairing effects on a drivers condition.
- ✓ Understand the importance of fatigue management

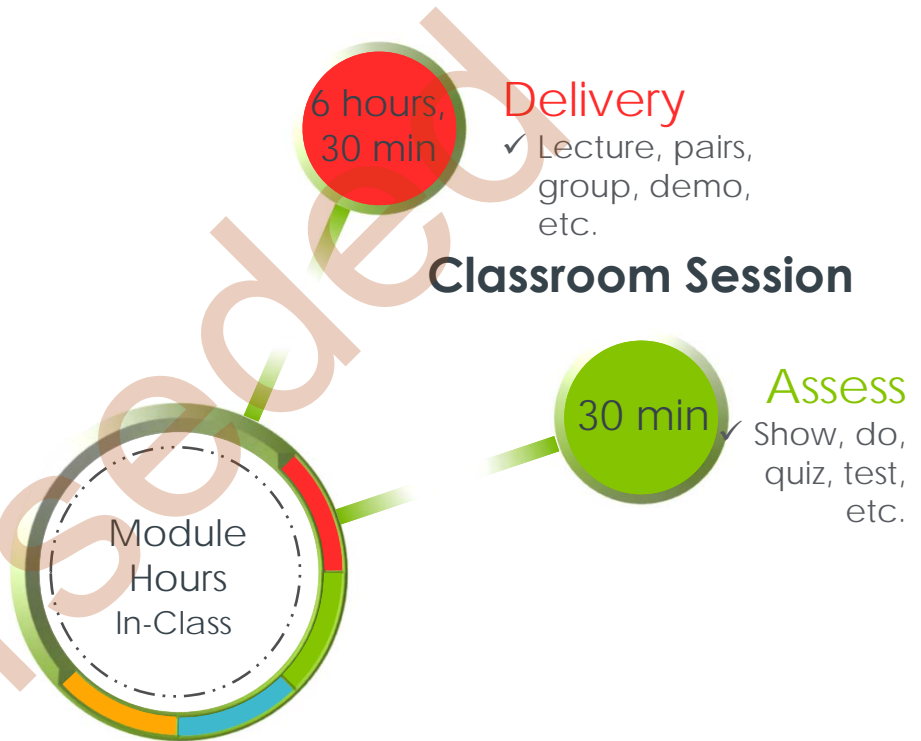



# Defensive Driving

The most influential factor to preventing a collision is?

# Defensive Driving

## THE DRIVER

Alberta

---

# Elements of Defensive Driving

To successfully avoid collisions, the professional driver requires a high degree of:



Alberta

# Knowledge

- Gained from formal training
- Practice
- Experience

Superseded



# Alertness

- Staying focused
- Free of distractions
- Detecting hazards
- Mental alertness

# Foresight

- Ability to anticipate
- Assess traffic situations far ahead
- Predict hazards

Superseded

# Judgment

- Recognition of alternatives in any traffic situation
- Ability to make proper choices to avoid a collision
- Knowledge and experience
- Critical thinking skills
- Intuition

# Skill

- Ability to manipulate the controls of the vehicle
- Perform basic traffic manoeuvres
  - Turns, passing, reversing, parking etc.
- Develop skills through learning
- Mastering the skill by doing them the right way every time



## Good Habits

- Developed by consciously practicing the proper way
- Performance becomes instinctive
  - Good visual search patterns

## Review

Defensive drivers are PRO-ACTIVE rather than RE-ACTIVE.

Elements of Defensive Driving are:

- Knowledge
- Alertness
- Foresight
- Judgment
- Skill
- Good Habits

# Steps for Avoiding Hazards

Defensive Drivers utilize the IPDE Method of driving:



## The IPDE Method

- Recognizing potential hazards before they become a real hazard
- Early recognition allows the time you need to avoid trouble
- Proper eye use is vital to see potential dangers

# Step 1 - Identify

The driver must be able to identify any real or potential hazards or dangerous situations.

- Early recognition allows the time you need to avoid trouble
- Proper eye use is vital to see potential dangers

# Step 1 - Identify

- A REAL HAZARD:
  - Is happening and will require an action from the driver
  - YOU MUST REACT
  
- What is some examples of REAL Hazards?

# Step 1 - Identify

- A POTENTIAL HAZARD:
  - Might happen and may require an action from the driver
  - YOU MAY HAVE TO REACT
- What is some examples of POTENTIAL Hazards?

## Step 2 - Predict

Predict likely outcomes for Real Hazards

- REAL Hazards?



## Step 2 – Predict Continued

Predict likely outcomes for Potential Hazards

- Potential Hazards?

## Step 3 - Decide

WHAT DID YOU DECIDE TO DO?

Alberta

---

## Step 4 - Execute

- Put your plan into action
  - Steer?
  - Brake?
  - Accelerate?

# The IPDE Method Review

As a group, think of 5 real and 5 potential hazards

Complete the entire IPDE process for each

How did you do?

# The IPDE Method Review

- The sooner you IDENTIFY
- The sooner you can PREDICT
- The sooner you can DECIDE
- The sooner you can EXECUTE

# The 6 Basic Driving Conditions

- There are six basic conditions in any driving situation
- Your ability to adjust to these conditions will increase your chances of avoiding a collision
- It is the driver's responsibility to adjust to these changing conditions

# The 6 Basic Driving Conditions

- These changes can be minor to very serious
- Can require little to no adjustments
- A driver may need to get off the road completely

# The 6 Basic Conditions – Cont.

**What are the 6 basic conditions?**



# The 6 Basic Conditions – Cont.



# The 6 Basic Conditions – Con't

## LIGHT CONDITIONS



- SEE and BE SEEN
- Natural vs artificial
- Night driving
- Glare from the sun
- Reflections
- Other head lights
- Smoke
- Fog
- Over cast
- Sunrise and Sunset



# The 6 Basic Conditions – Cont.

## WEATHER CONDITIONS



- Rain
- Snow
- Fog
- Affects visibility, traction and vehicle control



# The 6 Basic Conditions – Weather Cont.

## WEATHER CONDITIONS

What do you consider IDEAL weather conditions?

Alberta

---

# The 6 Basic Conditions – Cont.

## ROAD CONDITION



- Ice and Snow
- Rain
  - hydro-plane
- Road debris
- Pot holes

- Gravel
- Mud



Hydroplane



Contact

# The 6 Basic Conditions – Cont.

## TRAFFIC CONDITIONS

- Number of vehicles
- Type of Vehicles
- Pedestrians
- Time of Day - Time of Year
- Traffic Volume
- Location
  - Urban vs Highway
  - Residential vs City Centre
  - School Zone – Play ground



Alberta

# The 6 Basic Conditions – Cont.

## VEHICLE CONDITION

- Proper maintenance
- Tires - properly inflated, proper tread depth
- Windshield
- Major vs minor defects
- Season ready
- Wear and tear



Superseded



# The 6 Basic Conditions – Cont.

## DRIVER CONDITION



- Mental and physical sharpness/ health
- Zero impairment
- Zero Distractions
- Proper fatigue management
- Skill level: inexperienced vs experienced
- Knowledge
- Confidence



# The 6 Basic Conditions – Cont.

THE MOST IMPORTANT CONDITION

**DRIVER CONDITION**

Alberta

---

# The 6 Basic Conditions – Driver Cont.

## RECOGNITION AND DECISION ERRORS

Both of these can potentially arise from diminished mental or physical condition of the driver.

They can also arise from  
**POOR CHOICES**



# The 6 Basic Conditions – Driver Cont.

## RECOGNITION ERRORS



- Distraction (psychological, environmental, situational)
- General Inattention
- Inattention blindness
- Failing to identify changing conditions
- Improper visual search patterns (fixation)

# The 6 Basic Conditions – Driver Cont.

## DECISION ERRORS

- Speed
- Risk taking
- Failing to adapt to changing conditions
- Failing to obey traffic control indicators and laws



# The 6 Basic Conditions – Driver Cont.

## CIRCUMSTANCES OF RECOGNITION ERRORS



- Stress that diminishes a drivers capacity to operate a vehicle
- Health problems
- Money or Family issues
- Time pressures
- Distractions from in and out of the vehicle

# The 6 Basic Conditions – Driver Con't

## CIRCUMSTANCES OF DECISION ERRORS



- Inattention
- Environmental distractions
- Conscious choices to disregarding laws
- Over confidence – violate laws and rules of driving
- Unconscious decision errors – not identifying potential hazards
- Time management

# Review

What are the 6 Basic Conditions?

# Review - Answers

- Driver
- Vehicle
- Light
- Weather
- Road
- Traffic



# Review

What are the categories of errors?

# Review - Answer

● Recognition

● Decision

# Review

What is the most important condition?

## Review - Answer

# DRIVER CONDITION

Alberta

---

# Impairing Factors of Driver Condition

## EFFECTS AND CONSEQUENCES OF IMPAIRING FACTORS ON DRIVER CONDITION

- Alcohol
- Drugs
- Road Rage
- Distracted Driving

# Alcohol and Driving

A person's blood alcohol level is affected by their age, gender, body type/weight. The average drink is considered to be:

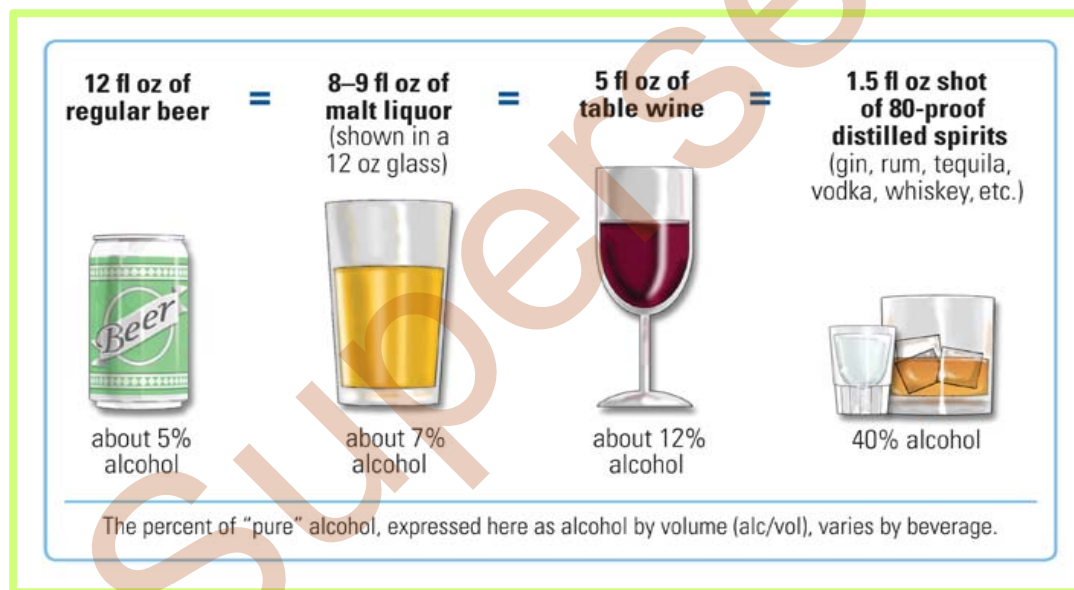

Alberta

# Impaired Driving

- Drugs (prescribed, non-prescribed, or illegal)
- Driving under the influence of any drugs can affect your driving ability
- Ask your doctor or pharmacist about any potential side effects of your medication.
- Over the counter medication requires the same attention
- Driving High is a DUI

# Impairment Vs. BAC

- Impairment is how you feel with the level of alcohol in your system
- BAC or Blood Alcohol Content is based 100% on the amount of Alcohol you consume
- Alcohol is measured in milligrams of alcohol per 100 milliliters of blood

0.04% BAC = 40mg/100ml

0.08% BAC = 80mg/100ml

Alberta



# Impairment is different than BAC

BAC (Blood Alcohol Content) begins with the very first drink.

Impairment can be influenced by:

- Rate of consumption
- Age
- Gender
- Body weight and type
- Food consumption
- Medication and Drugs
- Environment and Mood
- Fatigue and Stress
- Tolerance to alcohol

# Legal Consequences of impaired Driving

## Alberta Administrative Licence Suspension (AALS) program Summary

Sanction	Offence	Penalty
<b>Alberta Administrative Licence Suspension (AALS) program</b>	<ul style="list-style-type: none"><li>- Drivers with a blood alcohol concentration of over .08 per cent,</li><li>- A blood drug concentration over 2 nanograms of THC per millilitre of blood,</li><li>- A combination of 50 milligrams of alcohol per 100 millilitre of blood &amp; 2.5 nanograms or more of THC per one millilitre of blood, or</li><li>- Refusal or failure to provide a breath or fluid sample</li></ul>	<ul style="list-style-type: none"><li>- Immediate fixed term driving suspension</li><li>- Subject to remedial education courses and vehicle seizure</li></ul>

Alberta

# Legal Consequences of impaired Driving

## Immediate Roadside Sanction (IRS) program

Sanction	Offence	Penalty
Immediate Roadside Sanction (IRS) program	<ul style="list-style-type: none"><li>- drivers with a blood alcohol concentration of .05 to .08 percent</li></ul>	<p>Penalties vary depending on the number of times the driver has committed the offence; they include:</p> <ul style="list-style-type: none"><li>- Driver license suspension and vehicle seizure for 1<sup>st</sup>, 2<sup>nd</sup> and 3<sup>rd</sup> offence</li><li>- Completion of a remedial education course "Planning Ahead" for the 2<sup>nd</sup> offence, and</li><li>- Completion of remedial education course "IMPACT" for the 3<sup>rd</sup> offence</li></ul>

# Legal Consequences of impaired Driving

## Immediate Roadside Sanction (IRS) program

Sanction	Offence	Penalty
<b>24-hour Suspension program</b>	<ul style="list-style-type: none"><li>- Drivers that are suspected of being impaired by alcohol, drugs or a physical or medical condition.</li></ul> <p>This program allows peace officers who may not be authorized to conduct an impaired driving investigation to remove suspected impaired drivers from the road immediately, as well as drivers suspected of being impaired by fatigue or other physical conditions.</p>	<ul style="list-style-type: none"><li>- immediate 24-hour licence suspension</li></ul> <p>Note: Drivers that receive a 24-hour suspension for medical reasons may have their file reviewed by Alberta Transportation's Driver Fitness and Monitoring to determine their fitness to drive.</p>

# Class Activity

The only way for alcohol to leave your system is **TIME**.

There are no fast tracks to sobering up

Time	Activity	Sample BAC
Midnight	goes to bed	.25
1 a.m.	sleeps*	.235
2 a.m.	sleeps*	.22
3 a.m.	sleeps*	.205
4 a.m.	sleeps*	.19
5 a.m.	sleeps*	.175
6 a.m.	sleeps*	.16
7 a.m.	gets up for work	.145
8 a.m.	feels dry mouth	.13
9 a.m.	at work	.115
10 a.m.	still legally intoxicated	.1
11 a.m.	spills coffee	.085
Noon	still feels tired	.07
1 p.m.	mind feels foggy	.055
2 p.m.	feeling irritable	.04
3 p.m.	starting to feel better	.025
4 p.m.	head clearing	.01
5 p.m.	goes home	.00

Alberta

## Effects of Drugs Other than Alcohol on the Driving Task

- Perception
- Judgment
- Coordination
- Vision
- Mood

## Effects of Cannabis

- Loss of tracking ability
- Distance judgment
- Vigilance
- Divided attention

Superseded



# Criminal Code Convictions

New blood-drug concentration limits

Blood concentration level	<u>Federal criminal penalty</u> *
2 nanograms (ng) per millilitre (ml) but less than 5 ng/ml THC	Maximum \$1,000 fine (summary conviction)
5 ng/ml or more THC **	1st offence: Minimum \$1,000 fine
OR	2nd offence: Mandatory 30 days imprisonment
2.5 ng/ml or more THC combined with 50 mg/100ml or more alcohol	3rd offence: Mandatory 120 days imprisonment

<https://www.alberta.ca/impaired-driving-law-changes.aspx>





# Drugs and Driving

## Driving High is a DUI

- Over the counter medication
  - Tylenol, Advil, Nyquil, Sudafed, Gravol
- Prescription medication
  - Morphine, Valium, Ritalin, Prozac
- Illegal Drugs
  - Marijuana, Ecstasy, Cocaine, Heroin, Opium, Crystal Meth, Amphetamine, LSD, Speed, Inhalants, PCP

# Synergistic Effect

Mixing Alcohol and Drugs Together

1 + 1 = More than 2

Number of Drinks	Combined With	Equivalent to Number of Drinks
2	Antihistamine (Cold Remedy)	- 4 to 5
2	Marjuana (1 joint)	- 5 to 6
2	Tranquilizer (Valium - normal dose)	- Approximately 6
2	Gravol	- Approximately 6

Alberta

# Alcohol and Drugs Review

1. What Does BAC stand for?

- Blood Alcohol Content

2. What can lower BAC levels?

- Time

3. At what rate does alcohol leave the body?

- 0.015% per hour

## Alcohol and Drugs Review – Cont.

4. What Is it called when you mix Drugs and Alcohol?

- Synergistic Effect

5. What are the 3 categories of Drugs?

- Prescription, Over the counter, Illegal

6. What BAC limit will result in a Criminal Code Conviction?

- .08%

# 10 Impairing Effects of Alcohol

1. Reasoning/Judgment
2. Inhibitions
3. Memory
4. Vision
5. Speech
6. Hearing
7. Muscular Coordination
8. Consciousness
9. Automatic Processes
10. Death

## Reasoning/ Judgment

Your reasoning/ judgment is affected by first drink.

- This effect may not be noticeable
- Inability to think clearly/rationally
- Inability to make good decisions
- Impulsive or acting without thinking a situation is common

# Inhibitions

Inhibitions are a mental process imposing restraint upon behavior or another mental process.

When our inhibitions are impaired we may partake or demonstrate behaviors not typical to our personality.

- Overconfident
- Relaxed
- More outgoing
- Over emotional
- Dangerous, risky, impulsive behavior

## Memory

- Repetitive
- Forgetful
- Unable to store/recall memories
- Blackouts

Superseded





# Vision

- Visual acuity reduced (blurred vision)
- Reduced ability to control eye movement
- Reduced Peripheral Vision = Tunnel Vision
- Lack of depth perception
- Reduced ability to track moving objects
- Limited night vision & color distinction

# Speech

- Words slurred or run together
- Too loud for situation
- Volume fluctuates for no reason
- Slow or rapid
- Using wrong words or no words at all

# Hearing

- Auditory acuity is reduced
- Sounds are muffled
- Tolerance for loud noise increases
- Unable to determine the direction of sounds
- Excessive alcohol consumption can cause long term permanent hearing loss.

# Muscle Coordination

## ● Fine Motor Skills affected

- Hand – eye coordination
- Overall clumsiness
- Putting key into ignition

## ● Gross Motor Skills affected

- Legs weaken
- Loss of balance
- Bumping into things

## ● Slower reaction time or NO reaction time

# Consciousness

- Alcohol induced sleepiness
- Brain impaired beyond ability to function
- Loss of consciousness – Pass out
- Coma

Superseded



# Automatic Processes

- Heart Rate
- Breathing
- Body Temperature
- Liver
- Kidneys
- Bladder
- Digestion

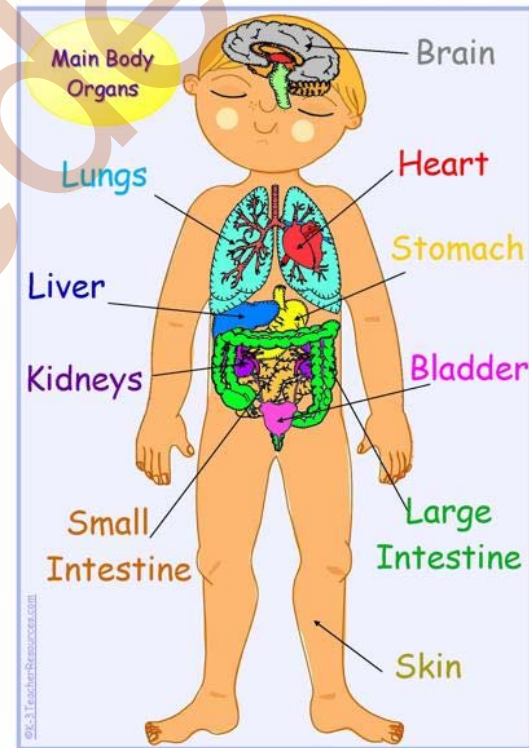

# Death

- Can occur during any of the previous stages
- Brain activity surges and then stops
- Body temperature drops
- Muscles tense – Rigor Mortis
- When Muscles relax all bodily fluids are released

# Effects of alcohol on Space Management

- Searching
- Eye Focus
- Double Vision
- Distance Judgment
- Side Vision
- Visual Acuity
- Color Distinction
- Night Vision
- Slowed Response Time
- Impaired Motor Skills
- Judging Distance



# Fatigue and driving

## FATIGUE

- Lack of sleep
- Medications
- Driving alone
- Driving long distances
- Driving at times the body is used to being asleep

## Fatigue and Driving – Cont.

- Stress
- Anxiety
- Illness – flu or cold to chronic illness
- Injuries

# Fatigue and Driving – Cont.

## Pre-Trip Mental Inventory

- Am I fully rested?
- Am I free from alcohol or other drugs?
- Am I feeling healthy?
- Am I able to concentrate on driving?
- Is my attitude courteous, careful and considerate?

# Fatigue and Driving – Cont.

## Warning signs of driver fatigue

- Yawning
- Inability to keep eyes focused and head up
- Having wandering, disconnected thoughts
- Driving the past few kilometres without remembering them. (highway hypnosis)
- Drifting between lanes
- Tailgating or missing traffic signs
- Noticing a vehicle in the rear-view mirror that seemed to appear out of nowhere

# Managing Driver Fatigue

The following actions will help prevent driver fatigue:

- Stop if you become sleepy while on the road
- Get plenty of sleep the night before a long trip
- Avoid working all day and then driving all night. Stay overnight rather than driving straight through
- Schedule a break every two hours or every 160 km
- Stretch or take a walk to get some fresh air
- Take a mid-afternoon break. Have a 20-40-minute nap
- Travel with an awake and alert passenger or let them drive

# Fatigue and Driving Review

What causes fatigue?

## Fatigue and Driving Review

- Lack of sleep
- Medications
- Driving alone
- Driving long distances
- Driving at times the body is used to being asleep

# Road Rage

What is road rage?

What can we do to minimize it?

I don't get road rage – but how much do I create?



# Road Rage – Cont.

## TIPS TO AVOID ROAD RAGE

- Plan your route in advance
- Don't bring your problems with you on the road
- Recognize stress and try to reduce it
- Be courteous to other motorists
- Don't take someone else's road rage personally

## Distracted Driving

- Visual – Takes your eyes off the road
- Manual – Takes your hands off the steering wheel
- Cognitive – Takes your mind off the driving task
- Fines for distracted driving - \$287.00 and 3 demerit points on your licence.

## Distracted Driving Law

The distracted driving law applies to all vehicles as defined in *The Traffic Safety Act* and distractions are not limited to the use of cellular phones, and include activities such as:

- Reading printed materials
- Writing, printing or sketching
- Personal grooming (brushing teeth, flossing, putting on makeup, shaving)
- Using electronic devices such as laptop computers, cameras, video entertainment displays and programming portable audio players (e.g. MP3 players)

# Managing Driver Condition

## Emotions and Distractions

SDP technique – Stop, Drop and Process

- STOP – Stop and think before you act
- Drop – Reduce the intensity of your emotions
- Process - Think about it!!

# Distracted Driving – Cont.

## **DISTRACTION IS A CHOICE!**

Keep your attention where it belongs and use the **Basic Collision Prevention Formula:**

- Collisions can be avoided if you practice IPDE:
  1. Identify - Recognize the hazard
  2. Predict – Predict the possibilities
  3. Decide – Make a decision
  4. Execute - Act in time

## Basic Collision Prevention Formula

- Recognize the hazard;
- Understand the defense;
- Act in time.

# Zone of Awareness

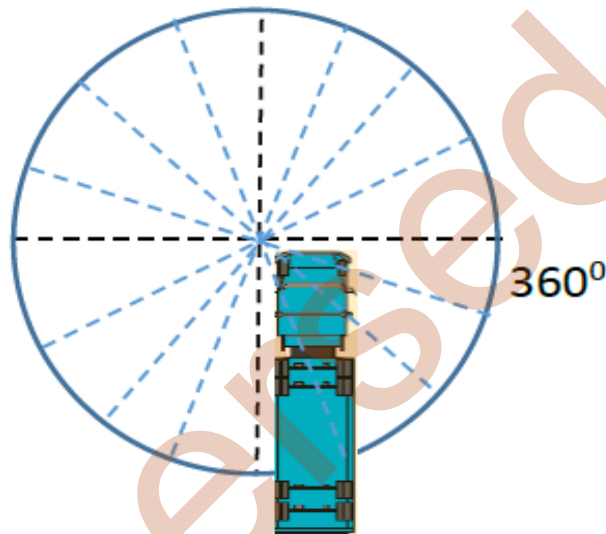

Use your senses to assess what is going on around your vehicle at all times.

## Use of Senses

Which senses will help you with your driving task?

- Hearing
- Feel
- Smell
- Vision



## Us of Senses Cont.

There are two interesting facts related to vision that you should be aware of:

- **Speed**

Peripheral vision is decreased  
as we travel faster

- **Steering**

We steer where we look

# Visual Search Patterns

Continuously scanning our surroundings on and off the road leads to good visual habits.

Specifically:

- Look up
- Reference down
- Sweep
- Fill in the Gap
- Mirrors/Gates & Gauges

## Good Visual Habit Tips

- Night driving
- Glare
- Unobstructed view
- Road side obstruction
- Other vehicles/Traffic

# Blind Spots

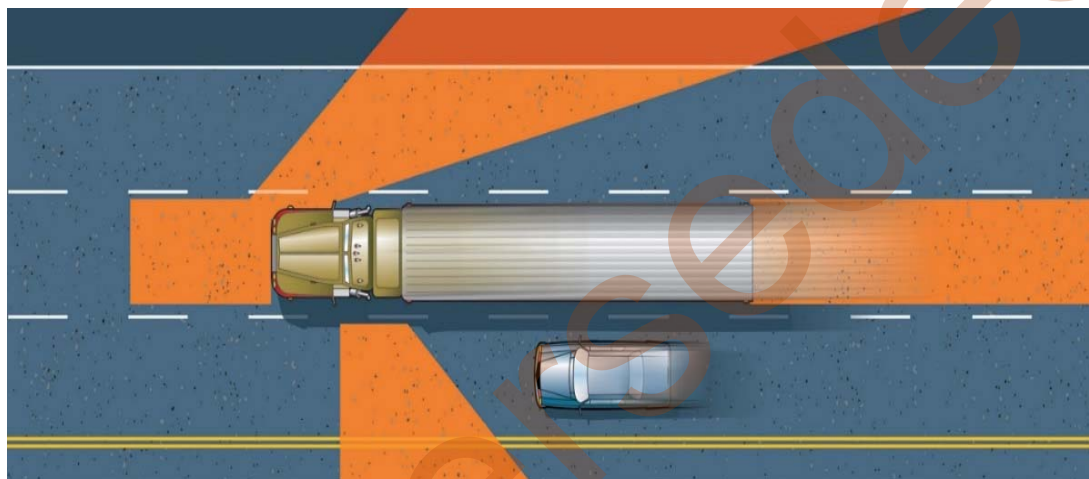

The areas around your vehicle you cannot see using your mirrors.

- The bigger the vehicle – The bigger the blind spot
- The smaller the vehicle – the easier it is to lose them in a blind spot.

# Detecting and Interpreting Clues

In our zone of awareness, we can detect and interpret clues that may lead to collisions by using our senses.

This is harder to do when you have to deal with

- parked vehicles
- Narrow Bridges and Underpasses
- Pedestrian Awareness
- Motorcycles and Bicycles
- Overtaking and Passing

Alberta

# Commentary Driving

- One of the best methods of hazard detection you can practice is 'commentary driving'.
- Commentary driving is a technique where the driver actually verbalizes (talks about) their main observations and interpretations of the events developing around and ahead of their vehicle.
- With regular practice, 'real observation' will become habit and you will not find it necessary to speak out loud. Silent but 'active' observation is just as effective for collision avoidance.

Alberta

# Review

When approaching a narrow bridge or underpass what do you need to do?

Supervised



## Review - Answer

- Hazard lights /4-way flashers
  - Slow down
  - Yield to oncoming traffic
  - Check clearance
  - Proceed
  - Hazard lights /4-way flashers off when through
-



## Class exercise

- Apply the IPDE step to demonstrate commentary driving relating to hazard identification and avoidance

# Types of Collisions

- Vehicles behind - Rear end
- Oncoming – Head on
- Loss of control
- Intersection or Angle – Turning
- Vehicles passing you – side swipe, cut off, run off the road

# Collisions with the vehicle behind

- Tailgaters
- Speed
- IPDE

# Collisions with Oncoming Vehicles

1. Why do they happen?
2. How can we avoid them?

# Collisions at Intersections

1. Why do they happen?
2. How can we avoid them?

# Collisions Caused by Vehicles Passing You

1. What to watch for/warning signs
2. 3 types of collisions
3. How can we avoid these situations

# Collisions Caused by You Passing

- ✓ Is it safe
- ✓ Is it Legal
- ✓ Is it Necessary

# Space Management

- Above
- Beneath
- What to look for
- How to manage



# Speed Management

1. What does speed effect?
2. What is meant by **IDEAL CONDITIONS?**
3. Who is responsible to adjust the speed of the vehicle?

# Consequences of Speeding

- Fines
- Demerit points
- Licence suspension
- Mandatory Court appearance

# Stopping a Moving Vehicle

In order to stop a moving vehicle a driver needs to perform three actions:

1. See

2. Think

3. Do

## Stopping a Moving Vehicle – Cont.

The distance a commercial vehicle needs to stop is affected by the following four factors:

1. Brake Condition
2. Traction
3. Weight
4. Speed

# Stopping Distance

1. Perception Time
2. Reaction Time
3. Lag Time
4. Braking Time

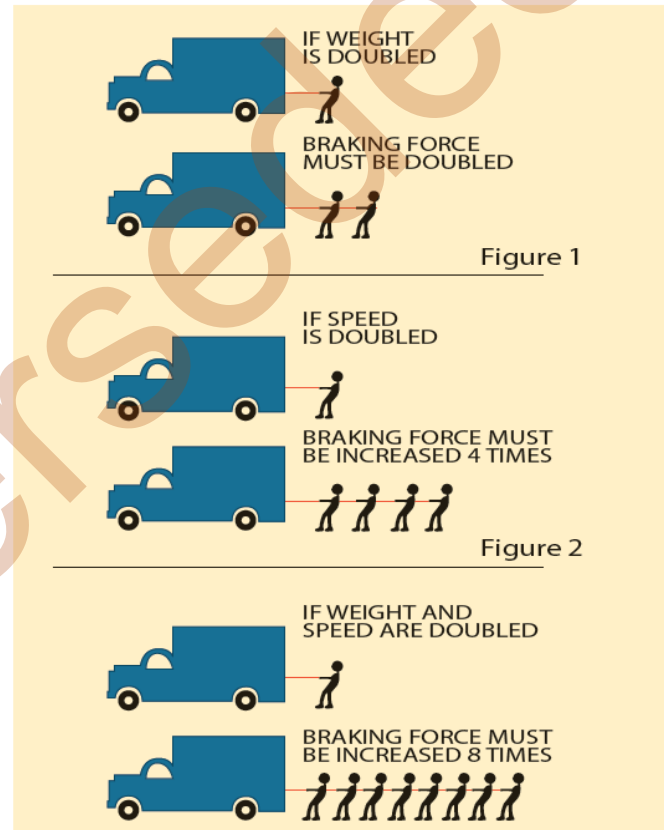

# Fueling and Fuel Efficiency

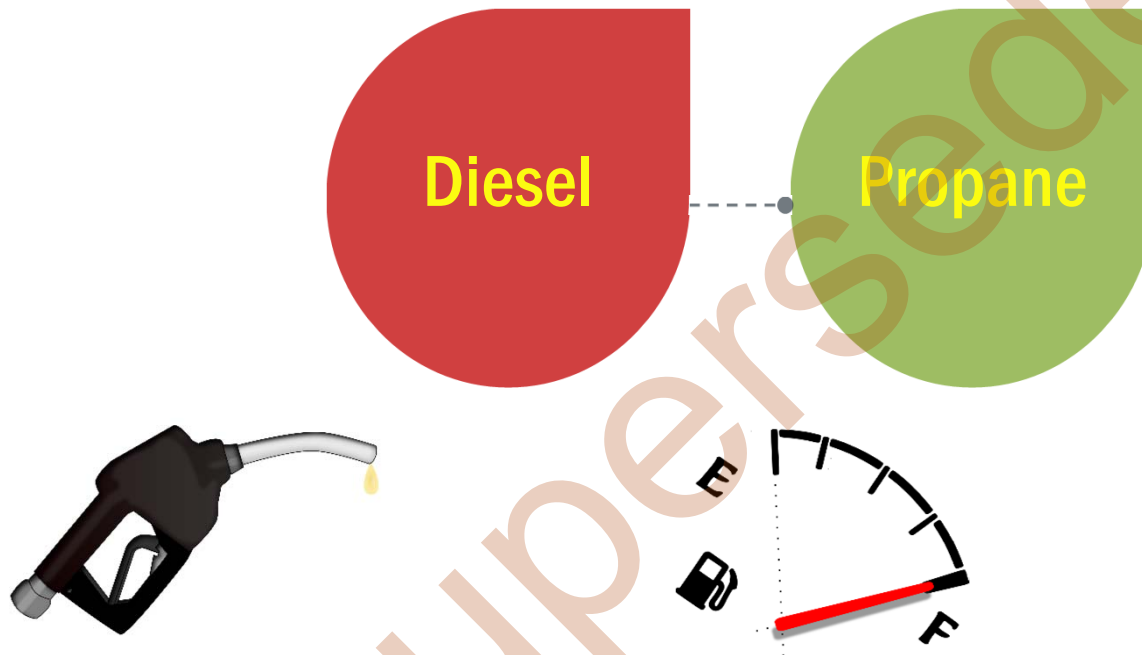

● The Do's and Don'ts of fueling

## Fuel Efficiency

Your driving habits can reduce the amount of fuel you burn.

Some tips for fuel efficient driving:

- Weather
- Preventative Maintenance
- Proper warm up
- Idling

## Review

What are some conditions that can affect your fuel efficiency?

Superseded



# Review- Answer

WIND  
SNOW COVERED ROADS

Alberta

---

## Review

What are some truck specific areas that create a less fuel efficient situation?

Superseded

## Review- Answer

UNDER INFLATED TIRES  
UNNECESSARY THROTTLE

Alberta

---

## Summary

- A proactive driver is a safe driver.
- Driving while fatigued can be just as dangerous as driving impaired.
- Following too close is one of the primary causes of collisions.
- Keeping your emotions in check will help you avoid road rage.
- Proper visual search patterns are the best way to avoid a collision.
- A good driver makes proper choices and avoids impaired driving.

● **ZERO TOLERANCE**

Alberta



# Questions?

---



# Module 5 – Off Road Tasks and Manoeuvres

Superseded

# Purpose

## Module 5:

- ✓ Learn and Demonstrate proper backing procedures
- ✓ Understand the Theory of Straight, Left and Right Backing
- ✓ Recognize the importance of following backing procedures
- ✓ 90-degree Alley-Dock, Blind Side and parallel parking Maneuvers
- ✓ Coupling and Uncoupling with trailer combinations

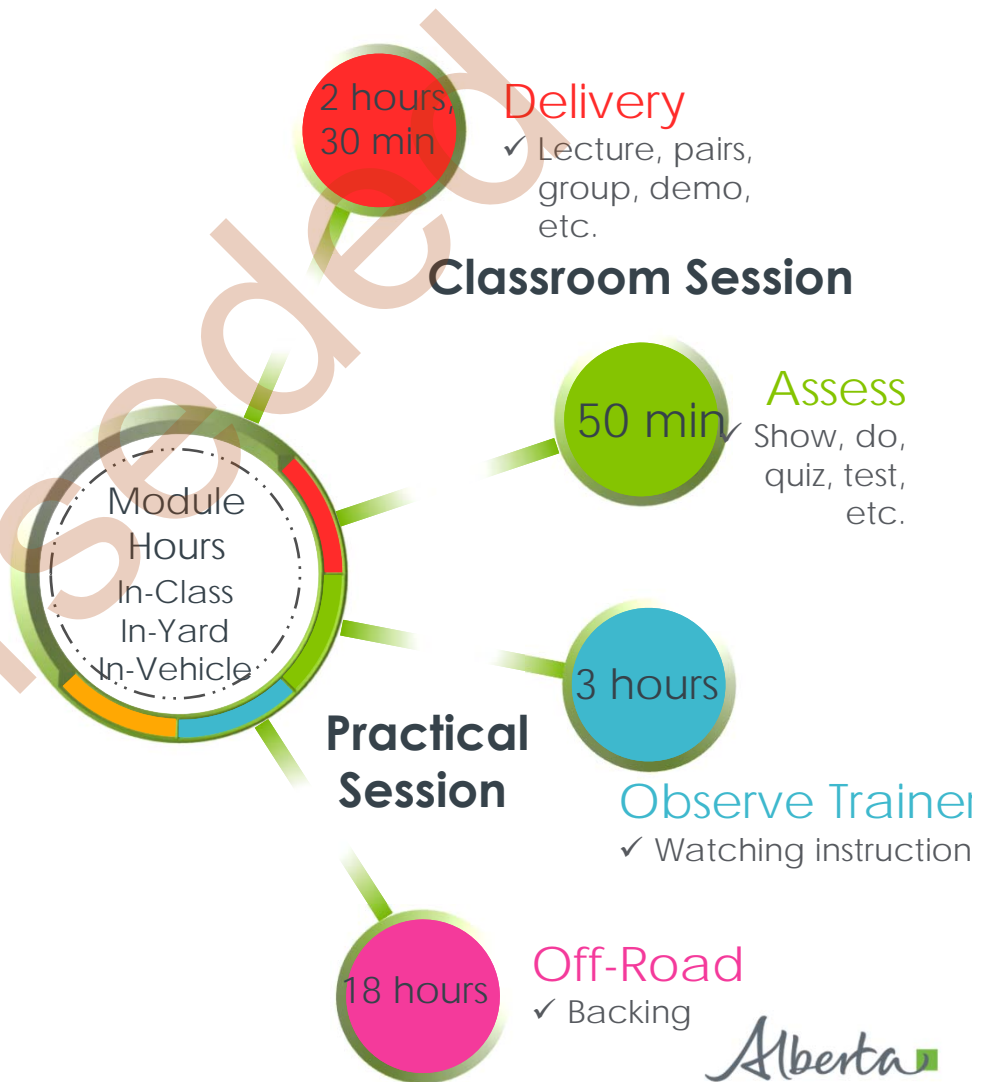

# Reversing/Backing

- Hazards of Backing
- How to be safe





# Reversing/Backing

Examples of hand signals

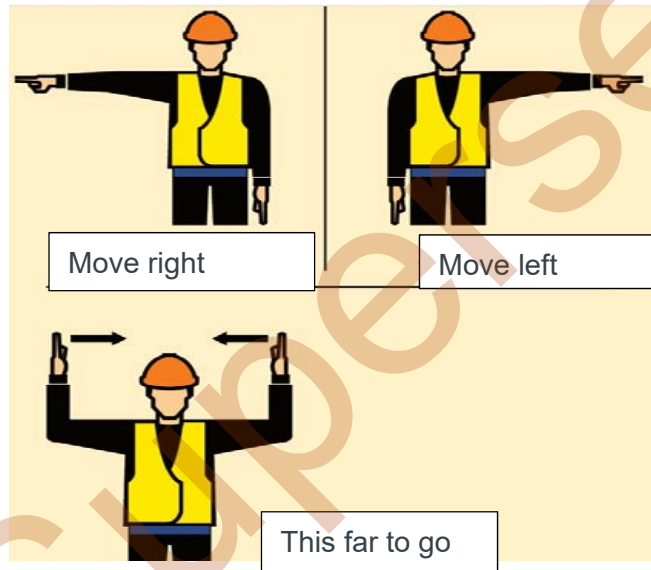

## Backing Maneuvers

- Straight line
- 90-degree Alley-Dock (left and right)
- Parallel parking (left and right)

# Straight Line Backing

- 4-way flashers and sound horn for all backing maneuvers

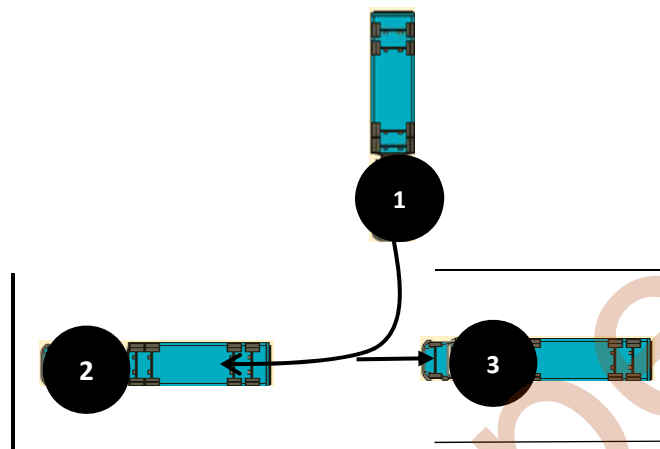

Straight backing. To space on left

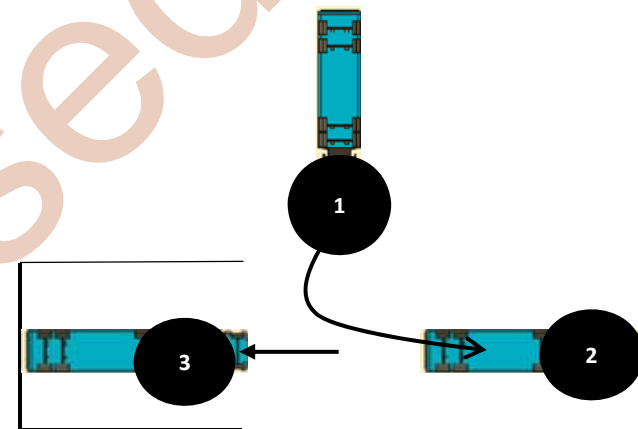

Straight backing. To space on right

# Alley-Dock Backing

- 90 Degree Reversing, Driver Side (Left Side)
- 90 Degree Reversing, Blind Side (Right Side)

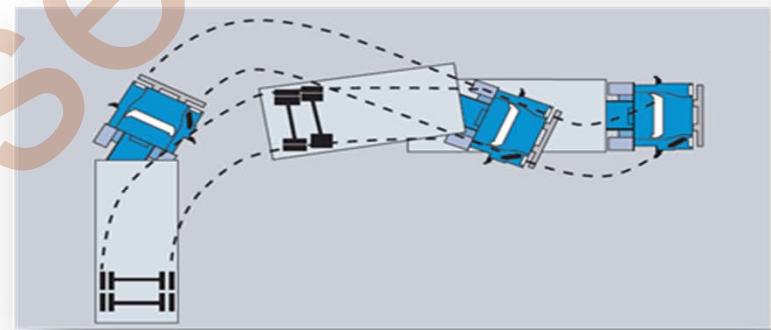
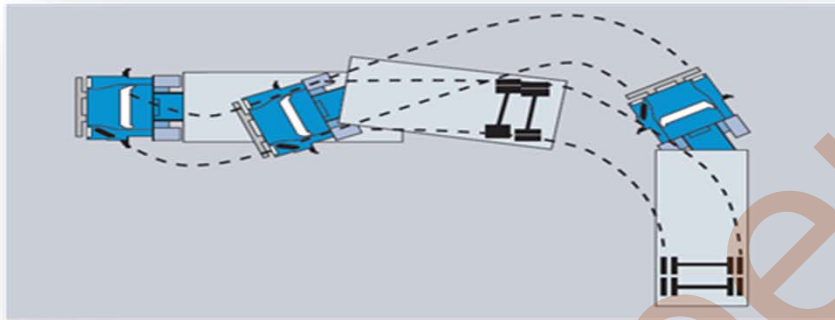

**This type of reversing is the most difficult and also potentially the most dangerous. Avoid it if you can.**

# Parallel Parking (Adjacent Parking Lane) Procedure

- parallel park a tractor-trailer to a left spot;
- parallel park a tractor-trailer to a right spot
- Before backing a tractor-trailer, it is important to ask yourself the following questions:

➤ Is it **NECESSARY**?

➤ Is it **LEGAL**?

➤ Is it **SAFE**?

Alberta

# Reversing/Backing- Review

Reversing a tractor-trailer in a hazardous movement

Is it safe?

Should only be done when necessary

Is it legal?

Is it necessary?

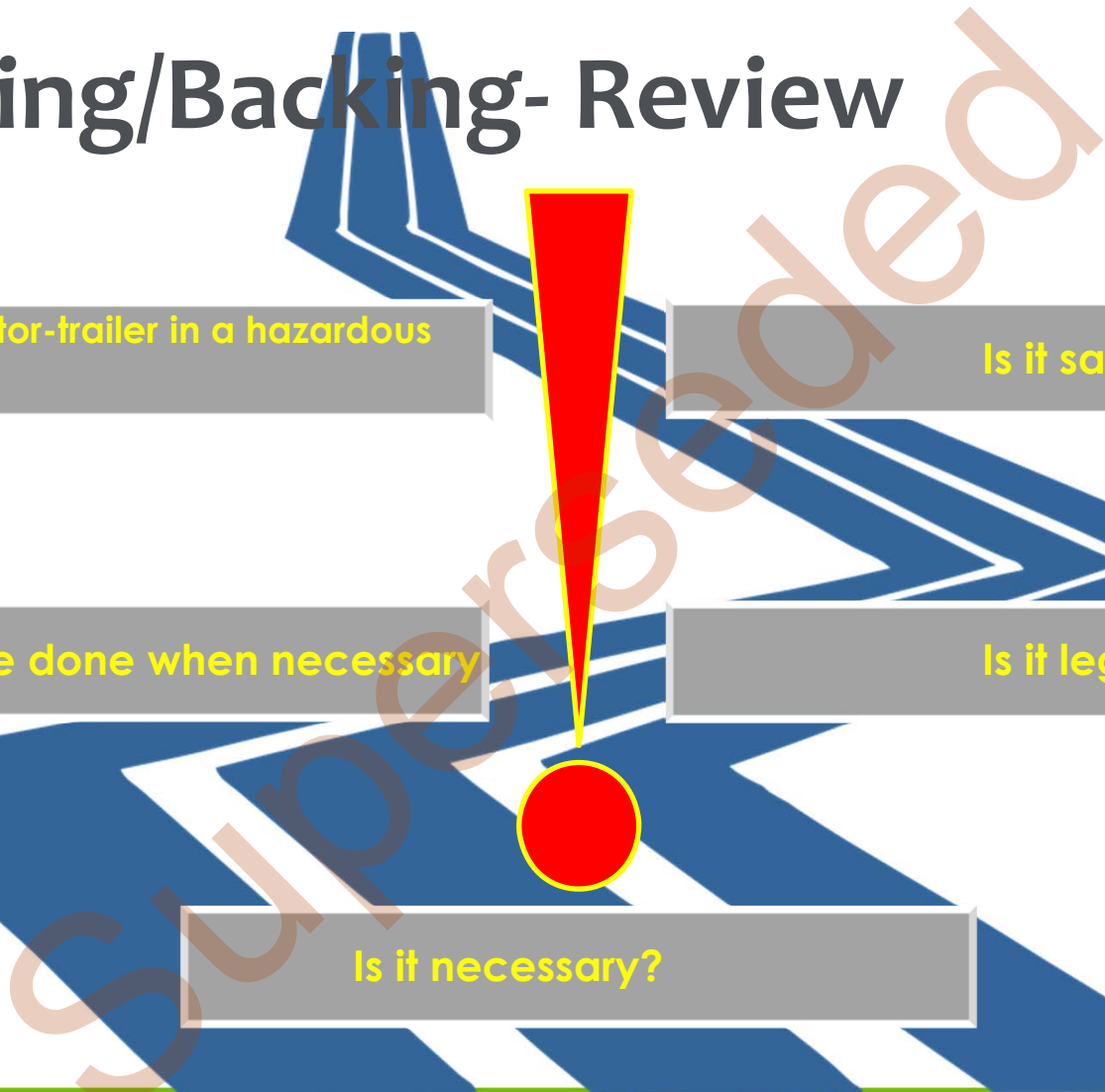

## Practical Training Guide

- A minimum of 12 hours will be spent practicing these 3 backing maneuvers by each trainee.
- The instructor will spend about 40 minutes to demonstrate each backing maneuver and techniques to the trainee.

# Practical Training – Straight Line

**Manoeuvre Space:** Straight-line backing manoeuver will be in a space that is between 3.5 and 3.7 metres wide and as long as  $\frac{2}{3}$  the length of the tractor-trailer.

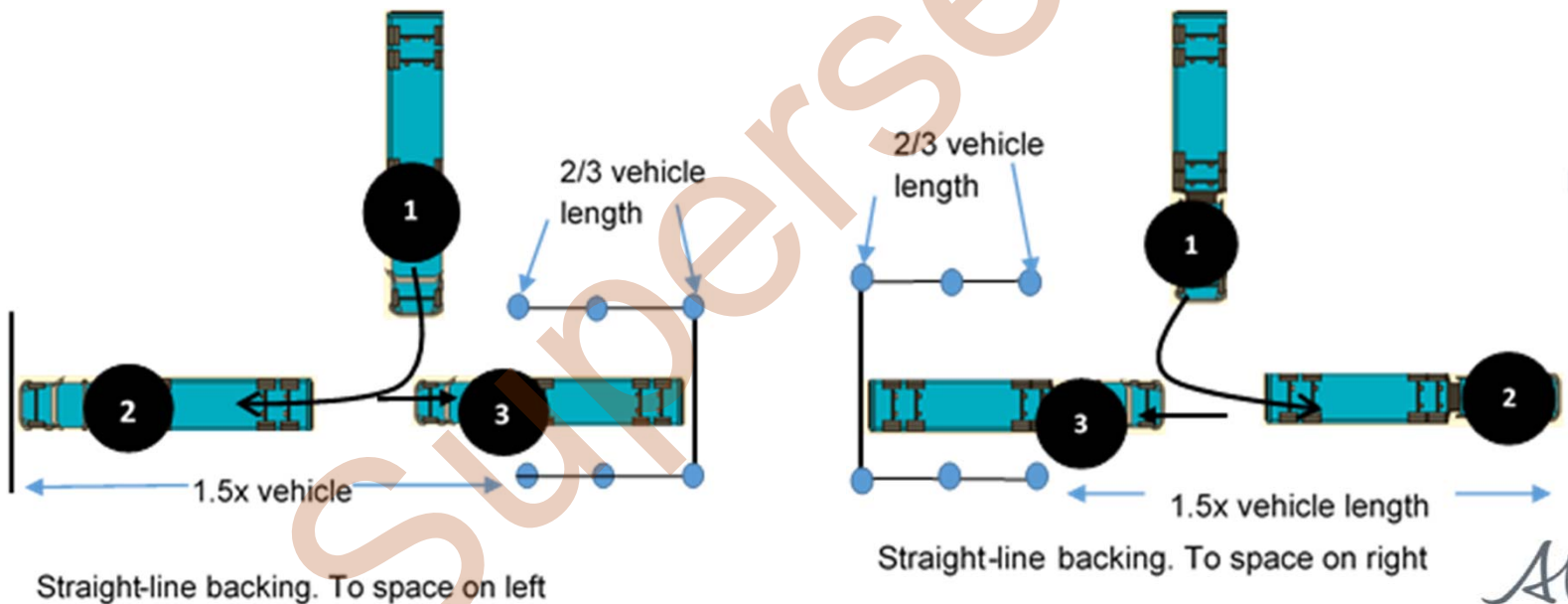



# Practical Training – Alley-Docking

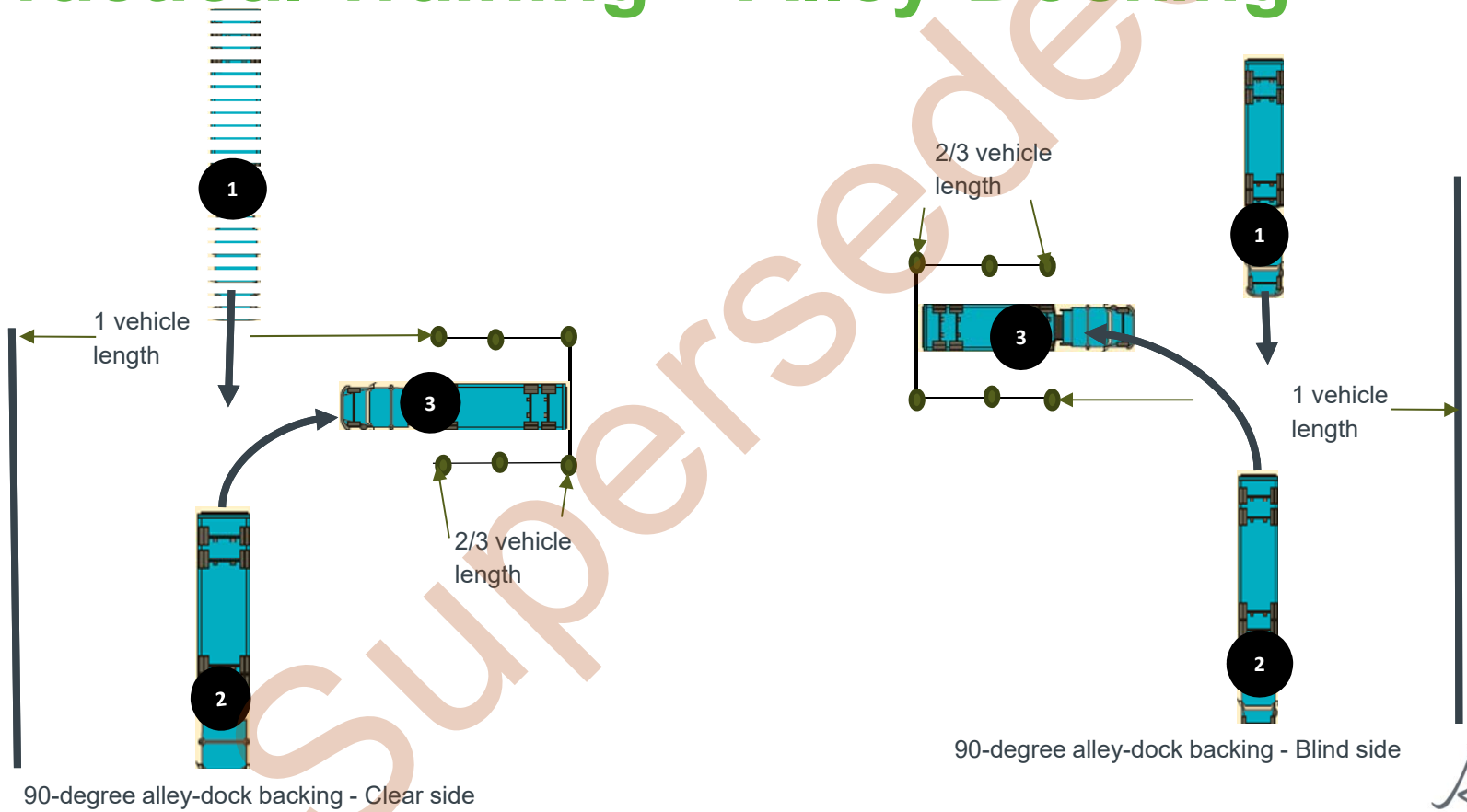

# Practical Training – Parallel Parking

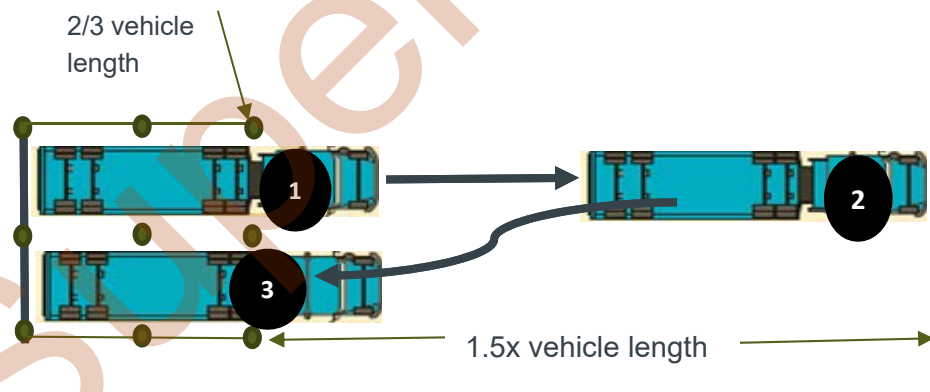
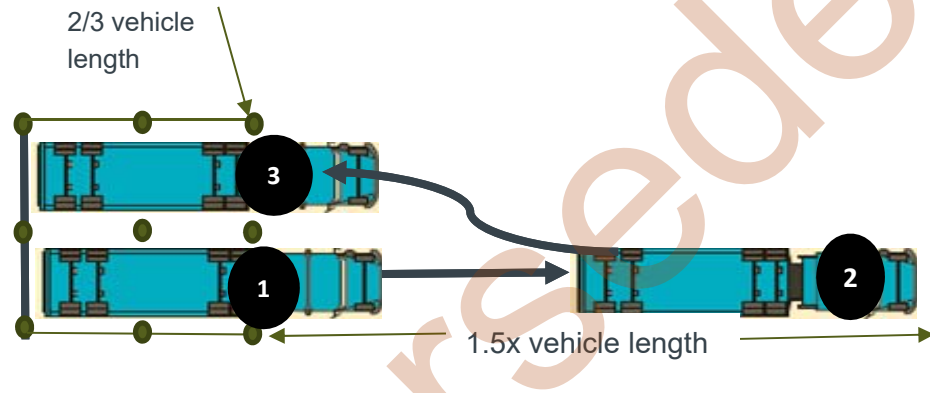

# Coupling and Uncoupling

Having the knowledge and skills to correctly connect and detach the trailer from the tractor is a major responsibility of every professional driver.

- 5<sup>th</sup> Wheel Position and its importance

# Coupling and Uncoupling

## 5<sup>th</sup> Wheel Position and its importance

- May be stationary or adjustable
- Sliding the fifth wheel will change the weight distribution.
- Moved forward, more of load is shifted to the steering axle.
- When moved backwards, the weight shifts to the drive axles.
- Too much weight is shifted forward makes steering difficult and you may lose traction.

# Coupling a Tractor-trailer

1. Inspection of the yard
2. Securing the vehicle
3. Inspection of the tractor
4. Inspection of the trailer
5. Align tractor and trailer
6. Latch 5<sup>th</sup> wheel
7. Tug Test
8. Confirm 5<sup>th</sup> wheel locked
9. Connect lines
10. Raise landing gear
11. Supply air check
12. Brake tests

# Uncoupling a Tractor-trailer

1. Location inspection
2. Park tractor-trailer
3. Secure the tractor-trailer
4. Chock wheels
5. Adjust suspension
6. Lower landing gear and stow handle
7. Remove connections
8. Unlock and disengage 5<sup>th</sup> wheel
9. Confirm stability of trailer
10. Clear trailer

# Double Trailer Combination Types

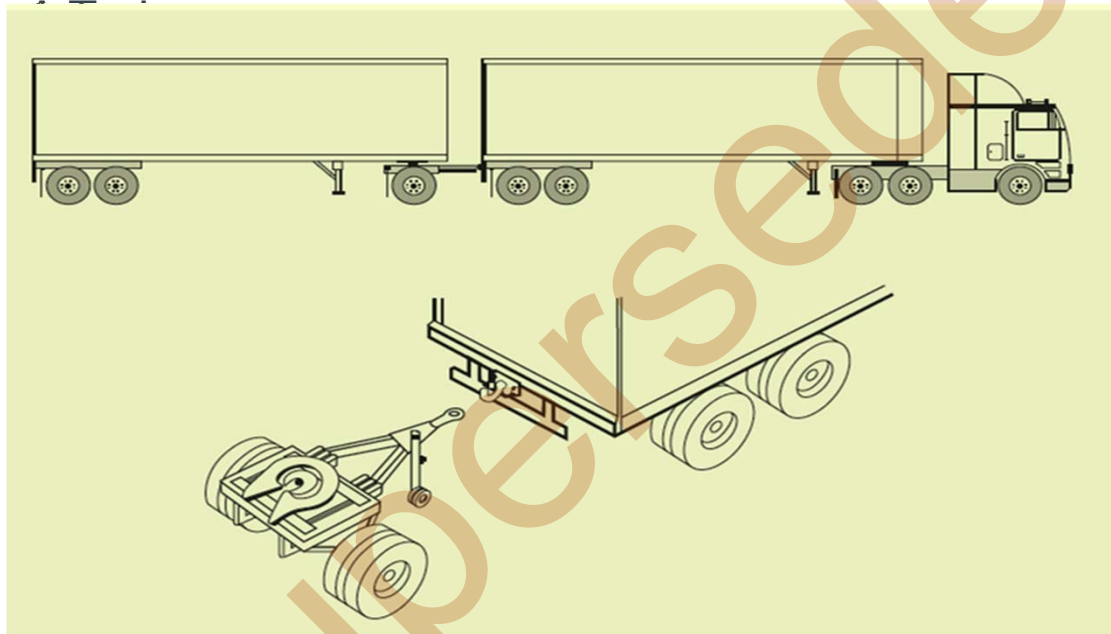

*A train- example of a unit connected by a type A converter dolly*

# Double Trailer Combination Types

## B Train

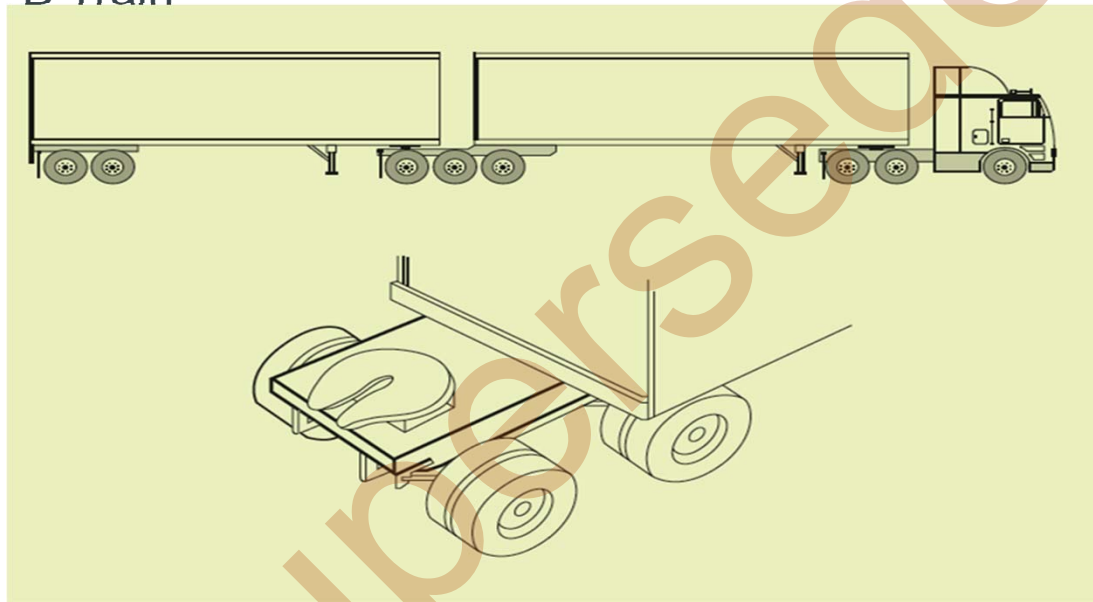

*B train - example of a unit connected by a type B converter dolly.*



# Double Trailer Combination Types

## C Train

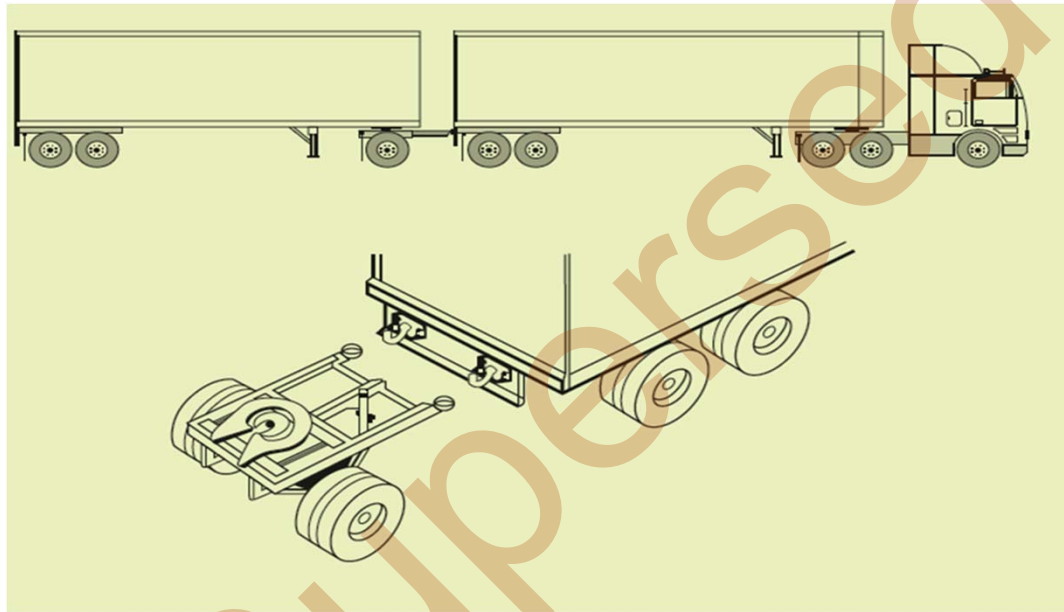

*C train - example of a unit connected by a type C converter dolly.*

# Link-up Arrangement

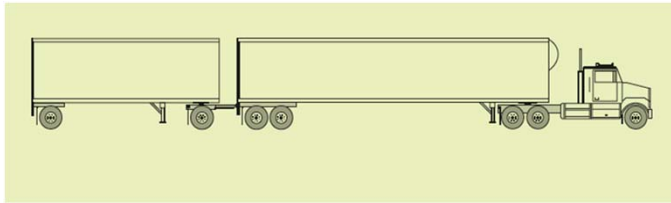

Rocky Mountain Double

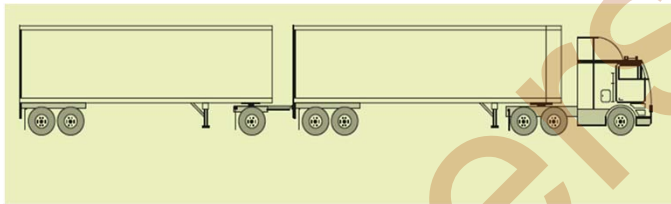

Turnpike Double

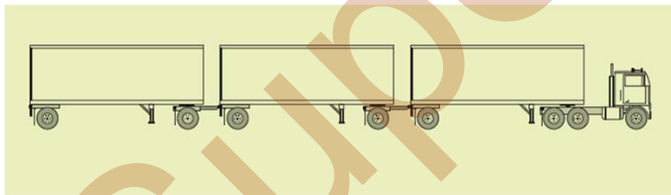

Triple

## Review

Prior to reversing, the driver should walk around the vehicle in a counter-clockwise direction and check for what?

# Review - Answer

- Obstacles
- Hazards
- Clearance

# Review

What are the 3 types of backing maneuvers you may encounter?

# Review - Answer

- Parallel
- Alley-dock
- Straight

# Review

When uncoupling a tractor-trailer, how should the trailer be parked?

# Review - Answer

In a straight line



## Review

When using a guide to help you back into a space, what are the most important things to remember?

## Review - Answer

- You must know what each signal means.
- The guide must make eye contact at all times with the driver.

## Summary

By knowing the hazards and how to properly back your unit as well as how to use a guide effectively, this will help eliminate the chances of a collision while backing.

# Questions?

---



Superseded

# Module 6 – Documents, Paperwork and Regulatory Requirements

Supersampled

# Purpose

## Module 6:

- ✓ Introduce the documentation requirements and work through the various forms that drivers may be required to complete
- ✓ Outline the purpose and importance of vehicle related documentation and associated regulations
- ✓ Outline the purpose of route preparation and safety

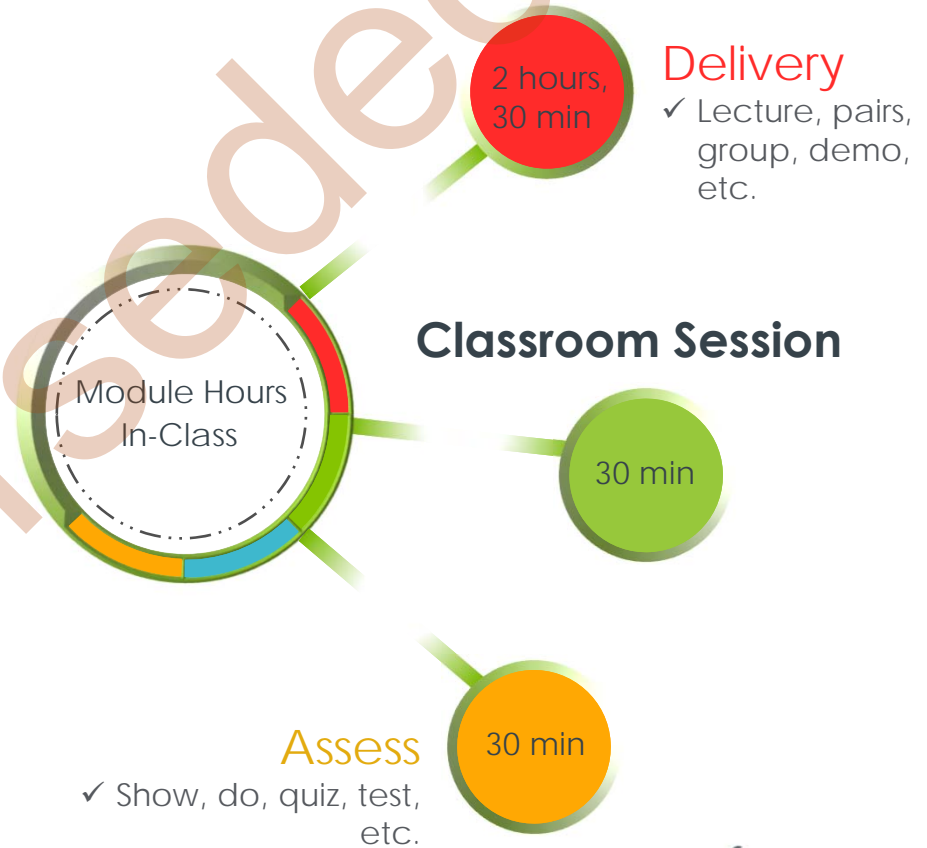

# Documentation Requirements

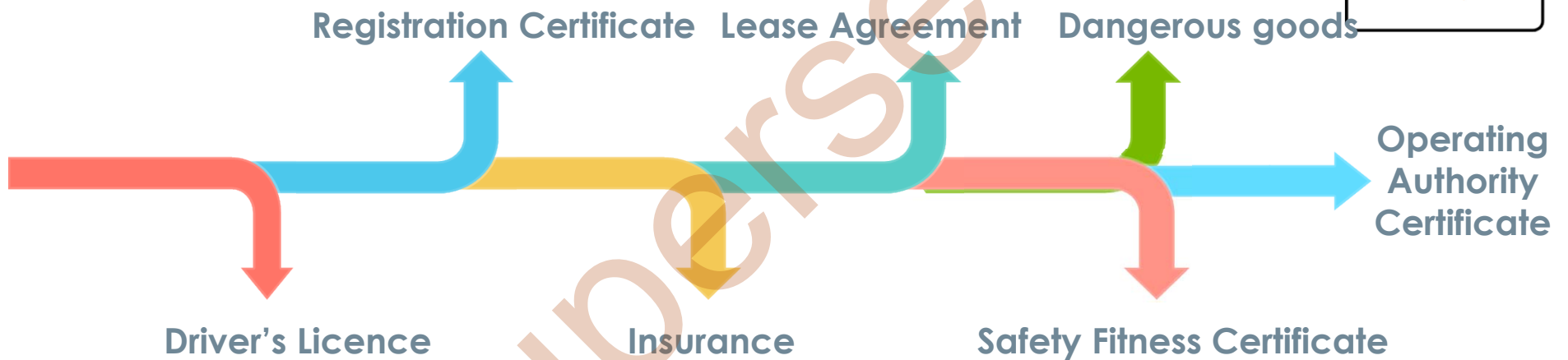

Alberta

# Documentation Requirements

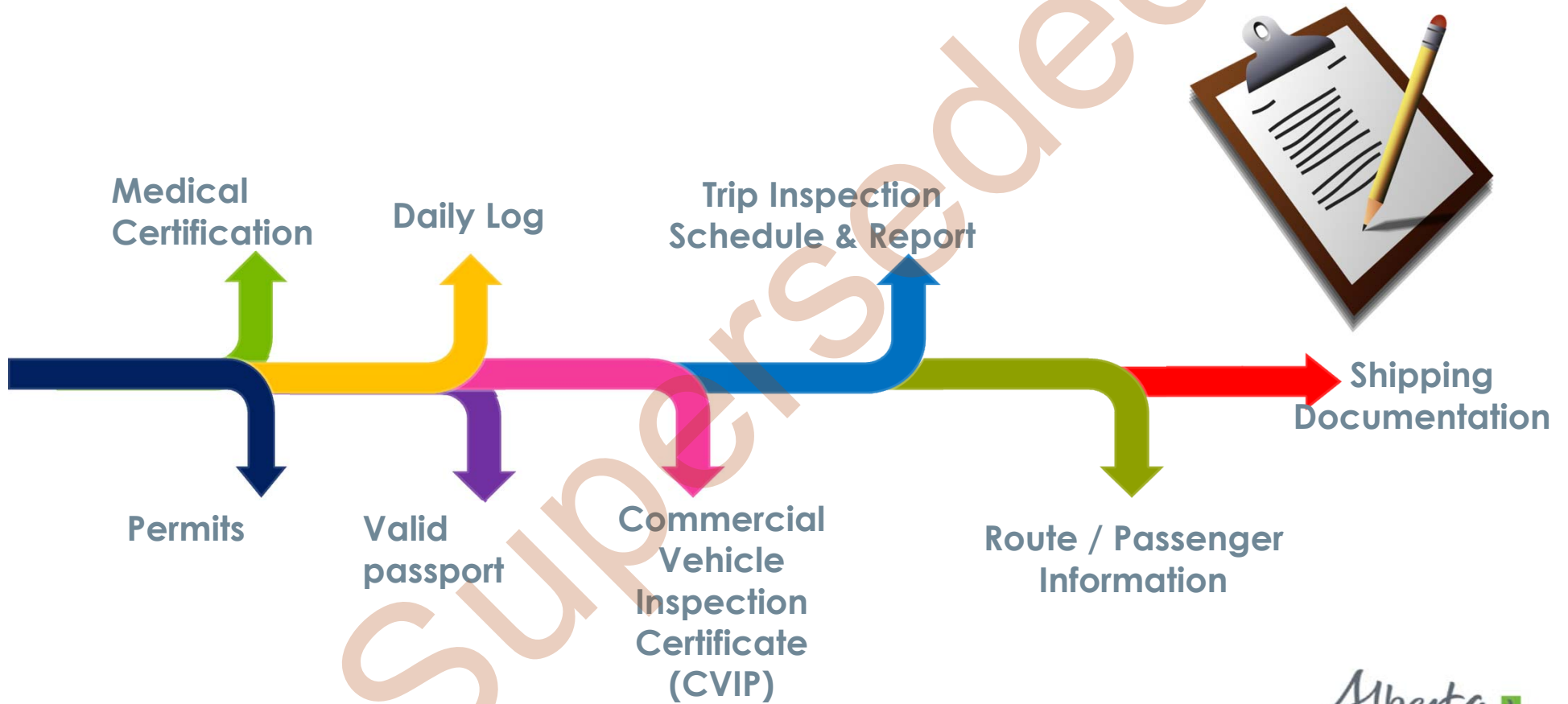

Alberta



# Driver's licence

- It is important that a driver holds the correct licence when operating a vehicle.
- A Class 1 driver may operate any motor vehicle or combination of vehicles, other than a motorcycle.
- A Class I drivers licence holder cannot operate a school with an "S" endorsement



# Review

What 2 types of vehicles are you not allowed to operate with a class 1 licence?

## Review - Answer

- School bus
- Motorcycle

## Registration and Insurance

---

- Carriers must ensure that their vehicles are registered, insured, have the appropriate vehicle plate class, and have the appropriate permits and certification to operate

## Registration and Insurance (Cont.)



Class 1 Plates - Commercial vehicles which are used provincially, federally and internationally for: Transporting an owner's own goods or another person's goods for compensation;  
- Passenger transportation services including school bus, charter bus and taxi operations.



Class 2 Plates - Commercial vehicles which perform special operations. Some operations include: Transporting goods within 10 km radius of the registered address; Operating provincially while conducting specific industry services. Refer to the regulations for more details.



Class 3 Plates - Commercial vehicles which transport goods owned by the owner of the vehicle. Commercial vehicles that are registered to and operated by governments, municipalities, hospitals, school boards or First Nations bands. A class 3 plate may NOT be used to transport other persons' goods for compensation.

# Registration and Insurance (Cont.)

## INSURANCE COVERAGE REQUIREMENTS FOR COMMERCIAL TRUCKS

### Public Liability and Property Damage

- \$1 Million (minimum) of liability and property damage insurance is required for all commercial trucks.
- \$2 Million if transporting Dangerous Goods as defined by Section 25 of the Alberta Commercial Vehicle Certificate and Insurance Regulation, AR 314/2002. Column 7 of Schedule 1 of the Federal Transportation of Dangerous Goods Regulations identifies the minimum quantities of each substance when an Emergency Response Assistance Plan must be filed with Transport Canada.

# Registration and Insurance (Cont)

---

## Cargo Insurance

- \$15,000 to \$32,000 of cargo insurance is required depending on the maximum registered gross weight of the vehicle hauling cargo. See the specifications chart below for details.
- If transporting goods owned by the carrier, then the carrier is not required to have cargo insurance.
- If transporting goods in Alberta that are listed on the next page, then no cargo insurance is required at any time.

# Registration and Insurance (Cont)

Specifications	Minimum Insurance Required
For each commercial vehicle engaged in the transportation of farm produce other than dairy products	\$600
For each commercial vehicle engaged only in the transportation of unprocessed milk or cream	Actual cash value of goods.
For each vehicle having a registered gross weight not exceeding 12,700 kilograms	\$15,000
For each vehicle having a registered gross weight exceeding 12,700 kilograms but not exceeding 18,000 kilograms.	\$20,000
For each vehicle having a registered gross weight of at least 18,000 kilograms but not exceeding 21,000 kilograms.	\$20,000
For each vehicle having a registered gross weight exceeding 21,000 kilograms but not exceeding 37,000 kilograms.	\$27,000
For each vehicle having a registered gross weight exceeding 37,000 kilograms.	\$32,000



# Registration and Insurance (Cont)

- Goods exempted from cargo insurance:

## Schedule 1 of the Alberta Commercial Vehicle Certificate and Insurance Regulation, AR314/2002

- |  |  |
|--|--|
| <ul style="list-style-type: none"><li>• Alfalfa (raw or pelletised)</li><li>• Animal feed and related concentrates</li><li>• Animal supplements (not for human consumption)</li><li>• Asphalt mix (bituminous)</li><li>• Brick</li><li>• Cement (dry or wet)</li><li>• Clay</li><li>• Coal</li><li>• Concrete products</li><li>• Condensate</li><li>• Crude oil</li><li>• Crushed glass</li><li>• Dead animals</li><li>• Drilling mud</li><li>• Fodder</li><li>• Garbage</li><li>• Grain</li><li>• Granite</li><li>• Granulite</li></ul> | <ul style="list-style-type: none"><li>• Herculite</li><li>• Lime</li><li>• Loam</li><li>• Logs</li><li>• Lumber</li><li>• Newspapers</li><li>• Organic manure</li><li>• Peat moss</li><li>• Propane</li><li>• Salt</li><li>• Sand</li><li>• Sawdust</li><li>• Scrap iron</li><li>• Septic tank refuse</li><li>• Snow</li><li>• Stone</li><li>• Sugar beets (raw or pelletised)</li><li>• Sulphur</li><li>• Water</li><li>• Woodchips</li></ul> |
|--|--|

# Review

Who is responsible to ensure the vehicle registration and insurance is proper?

## Review - Answer

- The carrier/owner

## Safety Fitness Certificate and Operating Authority Certificate

---

- Depending on how a carrier registers their vehicles, they may require a Safety Fitness Certificate and/or an Operating Authority Certificate
- The original or copy of the certificate must be carried in the vehicle

# Safety Fitness Certificate

Vehicle or Operation Type	Safety Fitness Certificate Required	Operating Authority Type Required	Vehicle Plate Class Required
Transporting Goods by Trucks, Tractors, and Trailers			
Driver Training School using vehicles registered for a weight of 11,794kg or more. Vehicle may not transport goods for compensation.	Yes	Not applicable	<b>Class 2</b> Restricted plate
Driver Training School using vehicles registered for a weight of 11,793kg or less operating solely within Alberta. Vehicle may not transport goods for compensation.	No	Not applicable	<b>Class 2</b> Restricted plate
Carrier is hauling goods using vehicle registered for 11,794kg or more	Yes	Not applicable	Class 1, 2, or 3

# Safety Fitness Certificate (cont)

Vehicle or Operation Type	Safety Fitness Certificate Required	Operating Authority Type Required	Vehicle Plate Class Required
Transporting Goods by Trucks, Tractors, and Trailers			
Carrier is hauling owner's own goods within a 10km radius of the carrier's registered address in Alberta.	Yes	Not applicable	<b>Class 2</b> Restricted plate
Carrier is a farm operation hauling owner's own goods to various points.	No	Not applicable	<b>Class 2</b> Farm plate
Carrier is hauling other persons' goods for hire within a 10 km radius of the carrier's registered address.	Yes	Not applicable	<b>Class 2</b> Restricted commercial plate

# Safety Fitness Certificate (cont)

**Alberta**  
Government

**SAFETY FITNESS CERTIFICATE**

CERTIFICATE NUMBER XXXXXXXXXX	CERTIFICATE HOLDER Example Transport (Alberta) Limited 4221 - 53 St. RED DEER AB T4N 2E1
ABC NUMBER ABxxx-xxxx	
MFC NUMBER XXXX-XXXXX	
OPERATING STATUS Provincial	Carrier Identification and Operating Status

ISSUE DATE: JANUARY 01, 2014

EXPIRE DATE (THE CERTIFICATE EXPIRES AS INDICATED BELOW UNLESS OTHERWISE SUSPENDED OR CANCELLED): Continuous

---  
This Carrier holds a SATISFACTORY UNAUDITED Safety Fitness Rating in the Province of Alberta.

This Certificate is issued pursuant to the Traffic Safety Act. The holder of this Certificate may operate vehicles anywhere in Alberta that are registered for a gross weight of 11,794 kilograms or greater, or designed with a seating capacity of 11 or more persons including the driver. This Certificate is not valid when the carrier operates or intends to operate outside of Alberta.

The original or a copy of this Certificate must be carried in vehicles operating under the authority of this certificate and produced on demand of a Peace Officer.

This Certificate may be cancelled where the holder has not operated a vehicle authorized by this certificate for a 12 month period.

This Certificate may be suspended or cancelled for failing to comply with transportation legislation.

All carriers must read the conditions on their Safety Fitness Certificate. For example, this certificate states that carriers with a "Provincial" Operating Status may not operate vehicles outside of Alberta.

DIRECTOR, ALBERTA TRANSPORTATION

# Operating Status

---

- Carriers who need a Safety Fitness Certificate must declare where they will be operating their vehicles in order to determine their Operating Status.
- Provincial Operating Status
  - Operate only in Alberta.
  - Commercial vehicle with a registered weight of 11,794 kg or more.
  - Commercial vehicle designed with a seating capacity of 11 or more including the driver.
- Federal Operating Status
  - Operate in multiple provinces, territories or states.
  - Commercial vehicle with a registered weight of 4,500 kg or more.
  - Commercial vehicle designed with a seating capacity of 11 or more including the driver.



## Commercial Vehicle Inspection Certificate

- Signed commercial inspection certificate
- Inspection decal
- 12 months
- Produce at request

# International Registration Plan (IRP)

- Agreement between Canada & United States
- Sharing of registration fees
- Federal carriers
- Cab cards

# International Registration Plan (IRP)

An IRP registration does not:

- Exempt from fuel taxes
- Exempt from certificates
- Permit operation outside of Alberta
- Exempt from height, length, width or axle limitations



Alberta

# Review

International Registration Plan (IRP) is an agreement between who?

# Review - Answer

Canada  
&  
United States

Alberta

---

# Review

IRP applies to which carriers?

# Review - Answer

Federal carriers operating  
in Alberta

Alberta

---

## International Fuel Tax Agreement (IFTA)

- Agreement between Canada and United States
- Operate in more than 1 location
- Quarterly fuel tax returns to base jurisdiction
- Gross weight 11,794 kg or more
- Where to apply



# Daily Trip Inspection Report

A driver is required to carry an [Inspection Schedule](#) and Daily Trip Inspection Report in the vehicle.

- Completed every 24 hours
- Major and minor defects for each item
- Major defect = out of service until repaired
- Minor defect = repaired before next inspection
- Paper or electronic
- Each inspection form must be kept in chronological order for each vehicle for at least six months after receiving it.

# Daily Trip Inspection Report

## Must include the following information:

- Licence plate or unit number of vehicle and trailers
- Odometer reading of the vehicle
- Carrier or company name
- Inspection date, time and location
- Name of the person conducting the inspection
- Declaration

## Daily Trip Inspection Report – Cont.

- Original report sent to home terminal within 20 days.

The carrier is then responsible for:

- Storing the records
- Each inspection and each vehicle

# Sample Truck/Trailer Trip Inspection Report

## Class Activity

**SAMPLE TRUCK/TRAILER TRIP INSPECTION REPORT**

**Time:** \_\_\_\_\_ **Date:** \_\_\_\_\_

**Carrier Name (as on registration):** \_\_\_\_\_

**Plate Number(s) and Jurisdiction(s)**

**Truck:** \_\_\_\_\_ **Lead Trailer:** \_\_\_\_\_

**Rear Trailer:** \_\_\_\_\_ **Other:** \_\_\_\_\_

**Location of Inspection (municipality or location on highway):** \_\_\_\_\_

Odometer Reading: \_\_\_\_\_ **OR**  Hubometer Reading: \_\_\_\_\_

I performed an inspection of the vehicle noted above using the criteria set out in Schedule 1 of Part 2, NSC Standard 13 and as per sections 10(4) and 10(10) of Alberta's *Commercial Vehicle Safety Regulation, AR 121/2009* and report the following:

**No defects were found.**

Defects were detected (check applicable):

Inspected	Defect	Major Defect	Vehicle Plate	Details of Defect (if any)
Air Brake System	<input type="checkbox"/>	<input type="checkbox"/>		
Cab	<input type="checkbox"/>	<input type="checkbox"/>		
Cargo Securement	<input type="checkbox"/>	<input type="checkbox"/>		
Coupling Device	<input type="checkbox"/>	<input type="checkbox"/>		
Dangerous Goods	<input type="checkbox"/>	<input type="checkbox"/>		
Driver Controls	<input type="checkbox"/>	<input type="checkbox"/>		
Driver Seat	<input type="checkbox"/>	<input type="checkbox"/>		
Electric Brake System	<input type="checkbox"/>	<input type="checkbox"/>		
Emergency Equipment and Safety Devices	<input type="checkbox"/>	<input type="checkbox"/>		
Exhaust System	<input type="checkbox"/>	<input type="checkbox"/>		
Frame and Cargo Body	<input type="checkbox"/>	<input type="checkbox"/>		
Fuel System	<input type="checkbox"/>	<input type="checkbox"/>		
General	<input type="checkbox"/>	<input type="checkbox"/>		

Glass and Mirrors	<input type="checkbox"/>	<input type="checkbox"/>		
Heater/Defroster	<input type="checkbox"/>	<input type="checkbox"/>		
Horn	<input type="checkbox"/>	<input type="checkbox"/>		
Hydraulic Brake System	<input type="checkbox"/>	<input type="checkbox"/>		
Lamps and Reflectors	<input type="checkbox"/>	<input type="checkbox"/>		
Steering	<input type="checkbox"/>	<input type="checkbox"/>		
Suspension System	<input type="checkbox"/>	<input type="checkbox"/>		
Tires	<input type="checkbox"/>	<input type="checkbox"/>		
Wheel Hubs and Fasteners	<input type="checkbox"/>	<input type="checkbox"/>		
Windshield Wipers/Fluid	<input type="checkbox"/>	<input type="checkbox"/>		

\_\_\_\_\_  
Name of person completing inspection  
*(Print Name)*

\_\_\_\_\_  
Signature of person completing inspection

**Provide details of defect(s) detected at any other time(s):**

\_\_\_\_\_

\_\_\_\_\_  
Name of person identifying defect(s)  
*(Print Name)*

\_\_\_\_\_  
Signature of person identifying defect(s)

**Certification of Repairs Completed:**

I certify all defects have been repaired I certify repair(s) were unnecessary.

**OR**

I certify repair(s) were unnecessary.

**Remarks:**

\_\_\_\_\_

\_\_\_\_\_  
Name of Certifier

\_\_\_\_\_  
Signature of Certificate

Alberta Government Commercial Vehicle Safety Compliance in Alberta Last Updated: March, 2018

Complete the Trip Inspection Report



# Review

How often should a trip inspection form be completed?

# Review - Answer

Once every 24 hours

Alberta

---

# Shipping Documentation/Cargo Information

Types of shipping/cargo documents:

- Bills of lading
- Waybills
- Dangerous goods
- Weigh slips
- Cargo packaging
- Delivery instructions

# Bill of Lading

Must include the following:

- Freight transporter
- Shipper
- Place
- Consignee
- Delivery location
- Manifest of contents
- Delivery instructions



# Way Bills

- Particulars of goods
- Name and mailing address
- Destination
- Names of connecting carriers
- Charge options (prepaid or collect)
- Date of consignment

# Dangerous Goods Shipping Documents

Dangerous Goods Shipping Document for Road Transport on CANADIAN SHIPMENTS						
<b>CONSIGNOR</b> Name: Address:			<b>DESTINATION (City-Town)</b> Name: Address:			
Name of Carrier		Prepaid <input type="checkbox"/>	Collect <input type="checkbox"/>	Transport Unit Number		
Point of Origin			Shipping Date		Shipper's No.	
REGULATED DANGEROUS GOODS						
UN Number	Shipping Name	Primary Class	Subsidiary Class	Packing Group	Quantity	Packages Requiring Labels
24-Hour Number: _____						
ERAP Reference _____ and Telephone Number _____						
<b>Consignor's Certification</b>						
I hereby declare that the contents of this consignment are fully and accurately described above by the proper shipping name, are properly classified and packaged, have dangerous goods safety marks properly affixed or displayed on them, and are in all respects in proper condition for transport according to The Transportation of Dangerous Goods Regulations.						
Name of Consignor: _____						
Special Instructions						
NON-REGULATED GOODS						
Packages	Description of Articles				Weight	
Received in apparent good order			Consignee's Signature _____		Shipper's Signature _____	
Received in Apparent Good Order		Driver's Signature _____			Driver's No. _____	
Please note that this sample shipping document contains some information that is not required in the TDG Regulations. The additional information reflects current industry practices.						



# Dangerous Goods

Shipping documents must be carried:

- Within drivers reach
- When leaving the vehicle
- Leaks or collisions

# Dangerous Goods



In the event of: leaks, unintentional release, near release, or collision:

- The local police;
- Alberta EDGE (Environmental and Dangerous Goods Emergencies) at 1-800-272-9600 (toll Free) or 780-422-9600 (Edmonton area);
- The owner of the vehicle;
- The employer.
- The person or company who owns the consignment of dangerous goods.

# Placards





**Example of a Placard for a Large Means of Containment**  
GASOLINE, UN 1203, Class 3, Packing Group II

		
--	---	---

Class 3 placards have a red background and a white flame symbol

**Example of Safety Marks for a Small Means of Containment**  
In this case the product is compressed nitrogen

	<p>NITROGEN, COMPRESSED</p>		<p>UN 1066 NITROGEN, COMPRESSED</p>
--	---------------------------------	--	---

Class 2.2 safety label is green with a white cylinder symbol

## Review

When hauling dangerous goods, who should be notified when there is a leak or collision?

## Review - Answer

- The local police
- Alberta Environmental and Dangerous Goods
- The owner of the vehicle
- The employer
- The person or company who owns the consignment of dangerous goods

## Review

When leaving the truck what should you do with the paperwork for the dangerous goods?



## Review - Answer

- Always within the driver's reach.
- If leaving the cab, place on the seat or in an obvious place.
- If leaving the shipment in a supervised area, leave a copy with the person in charge.

# Permits for Equivalent Level of Safety

- What is it?
- What does it do?
- Who is it issued to?
- When is it needed?

For more information refer to the web site: [www.transportation.alberta.ca](http://www.transportation.alberta.ca) and/or contact the Dangerous Goods Coordination and Information Centre at 1-800-272-9600 for further information on bulletins, permitting, and general information.

The image shows a thumbnail of a form titled "Application for Exemption by Permit (Alberta Equivalent Level of Safety)". The form is from the Alberta Government, specifically the Dangerous Goods, Rail Safety and 511 Alberta department. It includes contact information for Edmonton, AB T6B 2X3, and a phone number of 780-422-9600. The form is divided into sections, with "Section A: Stakeholder Information" visible, which includes a field for "Company Name".

Alberta Government

Dangerous Goods, Rail Safety and 511 Alberta  
4999 98 Avenue, Twin Atria Building  
Edmonton, AB T6B 2X3  
P: 780-422-9600 | F: 780-427-1044 |  
E: [TRANS.dangerousgoods@gov.ab.ca](mailto:TRANS.dangerousgoods@gov.ab.ca)

**Application for Exemption by Permit (Alberta Equivalent Level of Safety)**  
*Dangerous Goods Transportation and Handling Act, Section 5(1)*

**Section A: Stakeholder Information**

Company Name:

# Weigh Slips

- What is it?
- What does it do?
- Who is it issued to?
- When is it needed?

## Route

- Local operations
- Long-distance operations
- Cargo information
- Emergency information
- Emergency equipment

# Collision Reporting

- Injury
- Death
- Hit and run
- Impaired driver
- Out of province vehicle
- Towed

# If your involved in a collision

- Assist
- Protect the scene
- Notify
- Exchange information
- Do not discuss fault
- Record details

# Vehicle Weights and Dimensions

- Provinces and territories have laws that establish maximum vehicle weights.
- Drivers must be aware of weight restrictions that may apply to their vehicles
- Use the vehicle weight and dimension calculator - <http://www.transportation.alberta.ca/4779.htm>

# Vehicle Weights and Dimensions

Maximum Allowable Weight for Tractor Semi-trailer

Maximum Allowable Weight for Tractor Semi-trailer Sept. 13, 2018

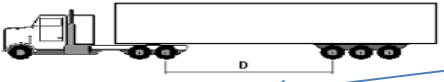

Select information about vehicle

Interaxle spacing: 5.5 m

Max. combined weight: [ ]

Percentage axle limit: 100 %

Axle Group	Number of axles	Tridem Axle Spread	Number of tires	Tire size	Rated tire capacity	Allowable axle weight	Notes
Steering	1		2	11 in.	2750		
Drives	2	2.4-2.80 m	8	235 mm.	2200		
Trailer	3	3.0-3.10 m	12	235 mm.	2200		

Maximum Allowable Gross Weight: [ ]

Calculate Weight [ ] Reset [ ] Minimum registered weight: [ ]

1. This function calculates the maximum allowable weights as per the Commercial Vehicle Dimension and Weight Regulation of the Traffic Safety Act. Where the information shown on this page is not in agreement with the regulation, the regulation shall prevail.
2. This function does not take into consideration the "gross axle weight rating" (GAWR) or the "gross vehicle weight rating" (GVWR) of the vehicle. The owner/operator of the vehicle should ensure that the weight carried is within the manufacturer's rated capacity specifications.
3. The "Rated Tire Capacity" is the rated capacity of one tire, based on either single or dual application, as stamped on the sidewall of the tire.
4. The steering axle weight for a truck tractor is capped at 6,000 kg.
5. When the interaxle spacing is less than the minimum specified in regulations, the combined axle weight for the combination is reduced by 500 kg for every 0.1 metre or portion thereof. This will also reduce the allowable GVW. Notwithstanding the requirements for the interaxle spacing, the trailers shall also conform to all other legal dimension requirements such as trailer wheelbase and overhang.
6. The maximum weight allowed on municipal roads is 17,000 kg on a tridem axle and 53,500 kg for the GVW. Permits may be available to exceed these weight limits, subject to municipal approval. Contact the Central Permit Office at 1-800-662-7138 (in North America) or 403-342-7138 for details.
7. [ ]
1. [ ]

Data that matches selected information will appear after the user clicks "calculate weight"



# Vehicle Weights and Dimensions

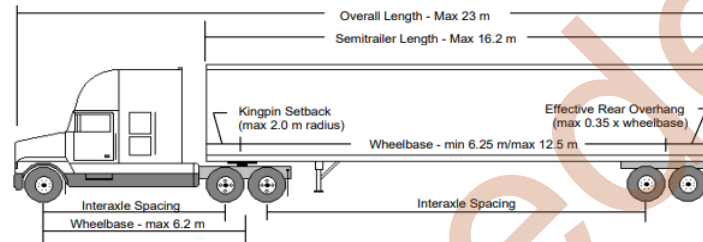

DIMENSION	LIMIT
<b>Overall Length</b>	Maximum 23 m
<b>Overall Width</b>	Maximum 2.6 m
<b>Overall Height</b>	Maximum 4.15 m
<b>Tractor:</b>	
Wheelbase	Maximum 6.2 m
Tandem Axle Spread	Minimum 1.2 m/Maximum 1.85 m
<b>Semi-trailer</b>	
Length	Maximum 16.2 m
Wheelbase	Minimum 6.25 m/Maximum 12.5 m
Kingpin Setback	Maximum 2.0 m radius
Effective Rear Overhang	Maximum 35% of wheelbase
Tandem Axle Spread	Minimum 1.2 m/Maximum 1.85 m
Tridem Axle Spread	Minimum 2.4 m/Maximum 3.7 m
Track Width	Minimum 2.5 m/Maximum 2.6 m
<b>Interaxle Spacings</b>	
Single Axle to Single, Tandem or Tridem Axle	Minimum 3.0 m
Tandem Axle to Tandem Axle	Minimum 5.0 m
Tandem Axle to Tridem Axle	Minimum 5.5 m

# Maximum Dimensions

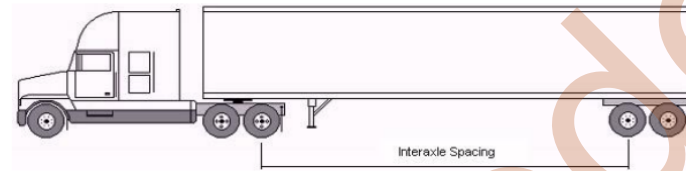

WEIGHT	LIMIT
<b>Axle Weights:***</b>	
<b>Steering Axle</b>	Maximum 6000 kg
<b>Single Axle</b>	
Single tires	Maximum 7300 kg
Super single tires	Maximum 7700 kg *
Dual tires	Maximum 9100 kg
<b>Tandem Axle:</b>	
Single tires	Maximum 13,600 kg
Super single tires	Maximum 15,400 kg *
Dual tires	Maximum 17,000 kg
<b>Tridem Axle:</b>	
Single and super single tires	Maximum 19,000 kg **
Dual tires with axle spread from 2.4 m to less than 3.0 m	Maximum 21,000 kg **
Dual tires with axle spread from 3.0 m to 3.7 m	Maximum 24,000 kg **
<b>Gross Vehicle Weight Limits</b>	
See Weight Calculator	Cannot exceed the sum of the maximum legal axle weights and is subject to minimum interaxle spacing.

\* Super single tires require "New Generation, Wide Base" tires with a minimum tire width of 445 mm. Available by permit only. Super single tires do not apply to the steering axle.

\*\* These weights for tridem axles apply to provincial highways only. The maximum weight for a tridem axle on a municipal road is 17,000 kg. Permits may be available to achieve heavier weights.

\*\*\* All axle weights are subject to minimum tire size. The maximum weight per tire shall not exceed the lesser of the tire manufacturer's weight rating or the width of the tire stamped on the sidewall multiplied by 10 kg/mm.

## Legal Weight

- Maximum weight standards
- What impacts legal Weight?
- Signage for weight
- Permits

# Over-Dimensional Safety Requirements

Over 2.60 metres wide (8' 6")	<ul style="list-style-type: none"><li>• Vehicle equipped with warning flags by day;</li><li>• Vehicle equipped with warning lights by night or during adverse weather conditions.</li></ul>
Over 3.05 metres wide (10')	<ul style="list-style-type: none"><li>• As above PLUS 2-dimension signs at the front and back of the vehicle in a manner that is clearly visible to approaching traffic.</li></ul>
Over 3.35 metres wide (11')	<ul style="list-style-type: none"><li>• As above PLUS 1 or more flashing lights.</li></ul>
Over 3.85 metres wide (12' 7")	<ul style="list-style-type: none"><li>• As above PLUS 1 pilot vehicle behind when on 4-lane road or 1 pilot vehicle in front when on 2-lane road;</li><li>• No movement after 3:00pm on a day preceding a weekend or stat holiday</li><li>• No movement on a Sunday or a statutory holiday.</li></ul>



# Over-Dimensional Safety Requirements (cont)

Over 4.45 metres wide (14' 7")	<ul style="list-style-type: none"><li>• Vehicle equipped with flags, signs, and flashing lights;</li><li>• On 2-lane road, need 1 pilot and 1 trailing vehicle;</li><li>• On 4-lane road, vehicles up to 5.5m wide (18') need 1 trailing vehicle;</li><li>• On 4-lane road, vehicles over 5.5m wide need 1 pilot and 1 trailing vehicle;</li><li>• No movement after 3:00pm on a day preceding a weekend or stat holiday</li><li>• No operation on highway on Sunday or a statutory holiday;</li><li>• Travel during DAYLIGHT HOURS ONLY.</li></ul>
Over 5.5 metres wide (18')	<ul style="list-style-type: none"><li>• As above PLUS other conditions as specified on the permit;</li><li>• Stopping on provincial highways only permitted at designated tractor-trailer pull-outs (except for emergencies and power line lifting);</li><li>• Travel during DAYLIGHT HOURS ONLY.</li></ul>
Over 5.3 metres high (17' 4")	<ul style="list-style-type: none"><li>• Notify power and telephone companies;</li><li>• Travel during DAYLIGHT HOURS ONLY</li></ul>

# Over Dimension Signs

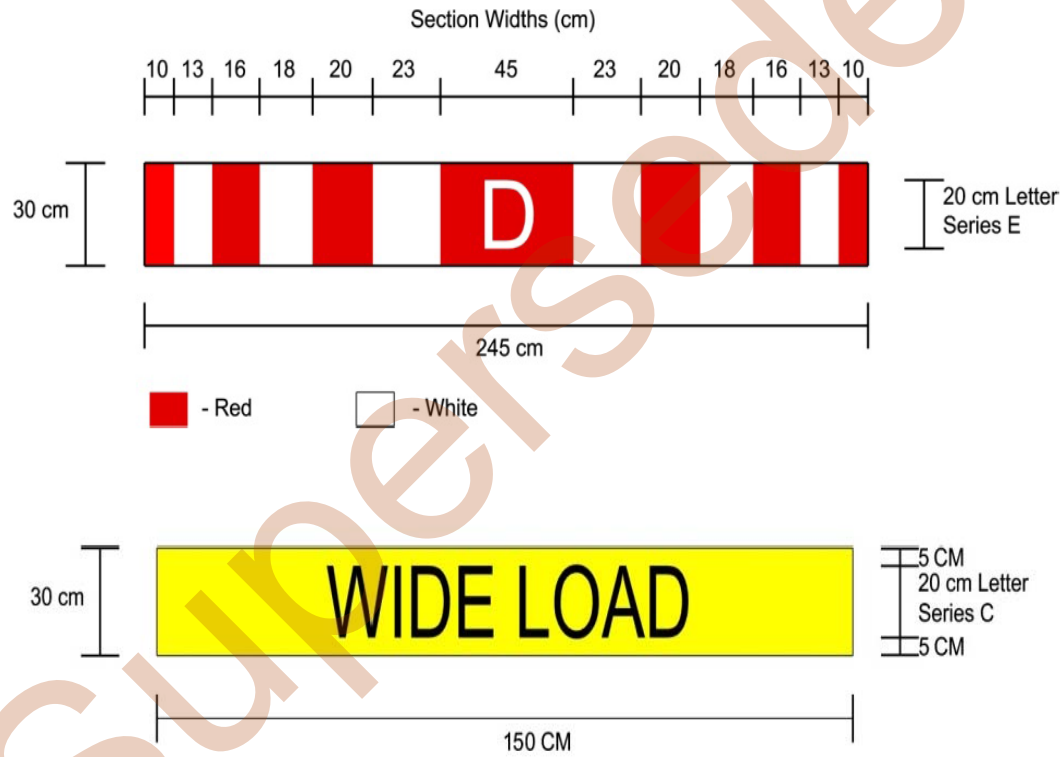

# Review

Who is responsible for making sure the proper permits are obtained for the shipment?

# Review - Answer

The carrier

Alberta

---



# Trip Planning

- What are the pro's to trip planning
- Effective and efficient
- Laws

# Road Restrictions and Bans

- Seasonal conditions
- Bridge maximum weights
- Over head structures
- Construction
- Up to date information on Road Restrictions and Bans, as well as information on Road Ban Permits, can be found on the Alberta Transportation website:  
<http://www.transportation.alberta.ca/522.htm>
- Toll free road ban information for provincial highways can also be obtained by dialing 1-855-ROADBAN (1-855-762-3226).

# Things to Consider

- Distance
- Time
- Essential services
- Weigh stations
- Traffic
- Vehicle
- Terrain
- Restrictions
- Boarder crossings
- Loading zones
- Expenses
- Weather
- Documents
- Emergency information
- Hours of service

# Tools for Trip Planning

- Dispatching system
- GPS
- CB (citizen band)
- When to use
- When not to use

# Calculating Travel Time and Fuel Usage

**Distance** = Speed multiplied by time

$$80 \text{ km} \times 9 \text{ hours} = 720 \text{ km}$$

**Average Speed** = Distance divided by time

$$720 \text{ km} / 9 \text{ hours} = 80 \text{ km}$$

**Trip Time** = Distance divided by average speed

$$720 \text{ km} / 80 \text{ km} = 9 \text{ hours}$$

Alberta

# Calculating Personal Needs

What might you need?

- Meals
- Lodging
- Fuel
- Enroute repairs
- Tolls
- Permits

# Ports of Entry

- Ports of Entry are locations that drivers must stop and prove that the carrier has authority to operate in the jurisdiction
- Inspections and weighing may take place at a port of entry.
- Drivers must follow directions and ensure that they are carrying all required documents.

# Roadside Safety Inspections

- Roadside Safety Inspections can be conducted at weigh stations, ports of entry, special safety inspection facilities, or a suitably safe area.
- The driver must produce their driver's licence, medical certificate, driver's logs, and cargo documentation.



## Planning Steps:

- Ensure that paperwork is current and correct.
- Select the route
- Estimate travel time and plan for stops
- Estimate need for fuel.
- Estimate food and accommodation costs

# Trip Planning – Review

## Tools for Trip Planning:

Dispatching system, Global Positioning Systems (GPS), 511 Alberta etc.

## Trip Considerations:

- Travel distance
- Departure and arrival times
- Essential services – where you can rest, eat, etc.
- Weigh station locations
- Traffic delays – rush hour, construction zones
- Vehicle Dimensions
- Loading zones
- Fuel costs, other expenses Etc.



## Calculating Travel Time & Fuel Usage:

$$\text{Distance} = \text{Speed} \times \text{Time}$$

$$\text{Average Speed} = \frac{\text{Distance}}{\text{Time}}$$

$$\text{Trip Time} = \frac{\text{Distance}}{\text{Average Speed}}$$

## Planning Steps:

1. Paperwork is current and correct
2. Select the route
3. Estimate travel time and plan for stops
4. Estimate the amount of fuel required
5. Estimate food and accommodation costs

Alberta

# Class Activity

## Formulas

### Calculating Travel Time & Fuel Usage

**Distance** = Speed multiplied by time

**Average Speed** = Distance divided by time

**Trip Time** = Distance divided by average speed



Alberta

## Workplace Safety and Emergency Equipment

- Safe use and operation of vehicles
- Proper record completion and retention
- Compliance with the law

## Workplace Safety and Emergency Equipment

- Use of safety equipment
- Driver conduct and discipline
- Driver qualifications

# Emergency Equipment

- Reflective triangles
- Fire extinguishers
- First aid kit
- Hazard lights

# Review

What are the recommended safety equipment commercial vehicles should carry?

## Review - Answer

- at least 2 Reflective Triangles
- Fire Extinguishers
- First Aid Kits
- Hazard Lights



# Review

Who is responsible for training specified safety and emergency equipment?

Supervised



# Review - Answer

## THE CARRIER

Alberta

---

# Questions?

---



# Module 7 – Vehicle Inspection Activities

Superseded

# Purpose

## Module 7:

- ✓ Recognize the importance of inspecting and maintaining a tractor.
- ✓ Understand the importance of a pre-trip checklist.
- ✓ Identify signs of potential problems.
- ✓ Know the correct under the hood procedure.
- ✓ Know the correct engine start-up and interior inspection procedure

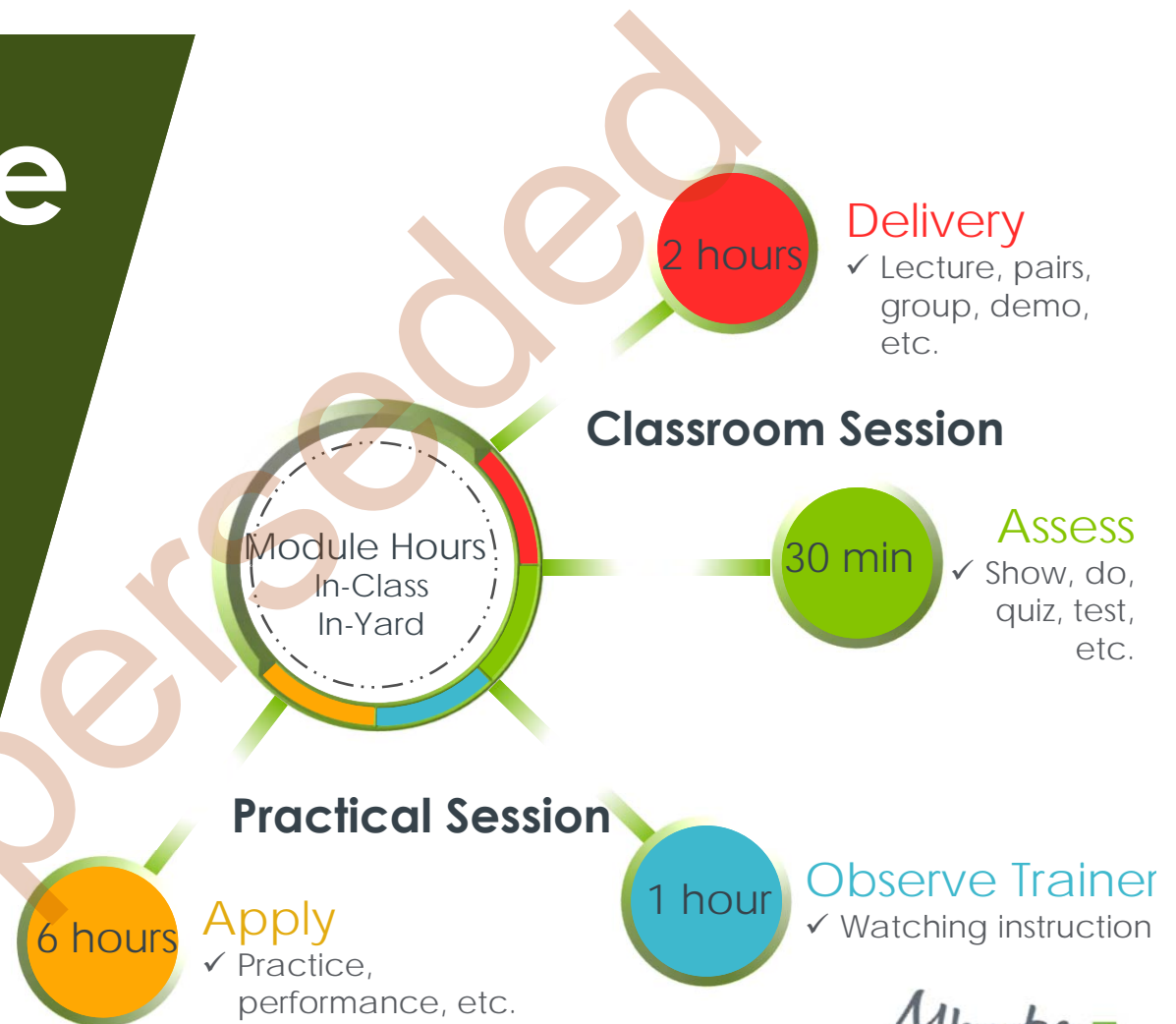

Alberta

# Introduction

- Early detection of problems or defects
- Legal requirement written maintenance program
- On-duty not driving

# Compliance with Vehicle Inspections

- Certificates and Decals.
- Other jurisdictions recognizing inspections.
- Not a replacement for preventative maintenance.

## Commercial Vehicle Safety Regulation

- The security of loads and Trip inspection regulations.
- Vehicles day-to-day safety.
- Definition of a commercial vehicle.



# Vehicle Defects

- Recording defects
- Reporting defects
- Driving with defects

Superseded



# Driver Inspection Requirement

- Valid for 24 hours
- When to produce the inspection report
- Out of service

# Trip Inspection Schedule

- Application of inspection schedule
- Where to get inspection schedules

# Trip Inspections

- Drivers accountability
- Circle procedure best for the vehicle and location
- The amount of time may vary
- Be safe – PPE

# Trip Inspections Cont.

## Under the hood inspection

Component	Inspection Points
Fluid levels	<ul style="list-style-type: none"><li>• all fluids must be at a safe operating level including:<ul style="list-style-type: none"><li>- engine oil</li><li>- engine coolant (do not remove radiator cap)</li><li>- power steering fluid</li><li>- windshield washer fluid</li></ul></li></ul>
Belts	<ul style="list-style-type: none"><li>• check all drive belts for tension, wear, cracks and fraying</li></ul> <p><b>Note:</b> never check the belts while the engine is running</p>
Hoses	<ul style="list-style-type: none"><li>• check all hoses for leaks, fraying or poor connections</li></ul>
Electrical wiring and connections	<ul style="list-style-type: none"><li>• check all wiring for bare wires or loose connections</li></ul>
Steering Components	<ul style="list-style-type: none"><li>• The power steering drive belt must not be missing, cut, frayed or badly worn</li><li>• Steering linkage system components are not loose or damaged and no excessive free play</li><li>• Bolts, nuts, clamps are not missing or badly worn</li></ul>

# Trip Inspections Cont.

## Exterior Inspection

Component	Inspection Points
Hood	<ul style="list-style-type: none"><li>• Hood latch is not missing or damaged and the hood is secure</li></ul>
Bumper, Fender	<ul style="list-style-type: none"><li>• Is not missing</li><li>• Is securely mounted</li><li>• Is not broken, bent or corroded or have sharp edges</li></ul>
Mirrors	<ul style="list-style-type: none"><li>• Should be securely mounted and adjusted to the appropriate setting for the driver</li><li>• Clean and clear to ensure proper visibility</li><li>• Check for damage that affects the proper functioning of the mirror</li></ul>
Windows	<ul style="list-style-type: none"><li>• Cracks, discolouration, exposed sharp edges, or missing parts</li><li>• Cracks that extend more than 50 mm into the area swept by the wipers or extend from one edge to another must be fixed</li><li>• Chips in any area swept by the wipers must not be greater than 13 mm in diameter</li><li>• Cracks or chips must not go through both layers of laminated glass</li><li>• Clean, clear and unobstructed to ensure proper visibility</li><li>• Driver's window can be opened from the inside</li></ul>
Doors	<ul style="list-style-type: none"><li>• Must function and seal properly from both the inside and outside of the vehicle</li><li>• Securely fastened to the vehicle and is not damaged</li></ul>

Alberta

# Trip Inspections Cont.

## Exterior Inspection continued

Component	Inspection Points
Inspection decals	<ul style="list-style-type: none"><li>• Properly affixed and valid</li></ul>
Frame (body, chassis, sliding sub frame, cross members)	<ul style="list-style-type: none"><li>• Cracks, corrosion, structural damage, deformation, missing or loose fastener</li></ul>
Underbody	<ul style="list-style-type: none"><li>• Structural damage, deformations, perforations, or presence of openings not designed by the manufacturer</li></ul>
Drive Shaft	<ul style="list-style-type: none"><li>• Missing, loose or damaged parts</li><li>• Excessive wear</li><li>• Universal Joints must not show evidence of free play</li></ul>
Brakes	<ul style="list-style-type: none"><li>• No cracks (other than heat crack)</li><li>• Damage to drum or disc</li><li>• Excessive wear on discs or inside drum must not exceed manufacturer's wear limit</li></ul>



# Trip Inspections Cont.

## Exterior Inspection continued

Component	Inspection Points
Suspension	<ul style="list-style-type: none"> <li>Excessive play for ball joints, control arm pivots, wheel and axle bearings</li> <li>Front and rear springs, shackles, U-bolts, centre-bolts, radius rods, control arms, torque arms, equalizers, sway-bars, stabilizers and their supports and attachments must not be loose, bent, cracked, broken, disconnected, displaced, perforated by corrosion or missing</li> <li>Shock absorbers must not be loose, bent, disconnected, missing or damaged, or show evidence of active fluid leakage</li> <li>Air bags must not be damaged or deflated</li> </ul>
Batteries	<ul style="list-style-type: none"> <li>Securely mounted, must not be loose, missing or have hold downs missing, battery cover is on and secure</li> <li>Check for corrosion or leaks</li> <li>Make sure battery cables are attached and secure</li> </ul>
Lights	<ul style="list-style-type: none"> <li>All lights must operate properly: headlights, hazard lights, signal lights, clearance, marker and identification lights, tail lights, and brake lights</li> <li>Components must not be damaged, discoloured, or be missing in whole or part</li> <li>Lamps must not be covered or modified in a manner that reduces the effective area of the lens or reduces the brightness of the light</li> </ul>



# Trip Inspections Cont.

## Exterior Inspection continued

Component	Inspection Points
Trailer electrical cord	<ul style="list-style-type: none"><li>• Properly secured, not loose so as to contact moving parts, rubbed through the insulation, peeled, cut or deteriorated</li></ul>
Air lines	<ul style="list-style-type: none"><li>• Properly secured, not dragging or rubbing, no leaks</li><li>• Service and supply lines secure, properly connected to the trailer, not leaking</li></ul>
Reflective tape	<ul style="list-style-type: none"><li>• Must be properly affixed and not damaged where required</li></ul>
Tires	<ul style="list-style-type: none"><li>• Tire pressure is maintained in accordance with manufacturer's specifications</li><li>• Excessive tread wear, tread separation, exposed cord, abnormal bumps, bulges or knots</li><li>• Cuts or snags that affect the safety of the tires</li></ul>
Wheels	<ul style="list-style-type: none"><li>• Wheel stud, bolt, clamp, nut, and lug must not be loose, missing, damaged, broken or mismatched</li><li>• Wheel assembly does not have any visible cracks, or bent in a way that affects the safe operation of the vehicle</li><li>• Hub must not be cracked, bent, distorted, worn, missing or leaking</li></ul>

Alberta

# Trip Inspections Cont.

## Exterior Inspection continued

Component	Inspection Points
Mud Guards/Flaps	<ul style="list-style-type: none"><li>• Secure, not damaged or missing</li></ul>
Exhaust System	<ul style="list-style-type: none"><li>• Missing, perforated, patched or insecure components</li><li>• Leaks</li><li>• No part of the exhaust system must be closer than 50 millimetres to wiring, any part of a fuel or brake component or any combustible material that is not protected by a shield</li></ul>
Fuel System	<ul style="list-style-type: none"><li>• Fuel tank is securely mounted/attached, fuel lines are present and secure and there are no leaks</li><li>• Filler cap is not missing and is secure</li><li>• Leaks</li></ul>
Fifth Wheel Coupling Device	<ul style="list-style-type: none"><li>• Fifth wheel is secured to vehicle frame and positive stops prevent the fifth wheel from shifting on the frame</li><li>• Jaw closure and locking mechanism is in good working order, not cracked or broken</li><li>• Jaw closure is not worn beyond 6.4 millimetres</li><li>• Slider mechanisms (if equipped) are locked securely, do not show signs of failure or excessive wear, are equipped with stops</li><li>• Saddle bushings must not be worn in excess of manufacturer's specifications</li><li>• Upper plate is not loose, cracked or warped</li><li>• King pin is not loose, cracked, deformed or have wear in excess of 3.2 millimetres</li></ul>

# Trip Inspections Cont.

## Exterior Inspection continued

Component	Inspection Points
Landing Gear	<ul style="list-style-type: none"><li>• Raised, secure, no cracks, bends or missing parts</li><li>• Handle must operate smoothly and easily and be properly stowed</li></ul>
Load or Cargo	<ul style="list-style-type: none"><li>• Properly secured as per regulations</li></ul>
Tailgate/Cargo Doors	<ul style="list-style-type: none"><li>• Closed and properly secured</li><li>• No structural damage or damage to hinges and latches</li></ul>
Rear Impact Guard/Bumper	<ul style="list-style-type: none"><li>• Must not be missing, bent or broken, or have cracked welds</li><li>• Must be securely mounted</li></ul>

# Trip Inspections Cont.

## Interior Inspection

Component	Inspection Points
Heating and Defrosting Systems	<ul style="list-style-type: none"><li>• Visible portions of the hoses and piping for the interior heaters routed within the occupant compartment must not be rubbed, cracked or leaking</li><li>• Windshield defroster system must deliver heated air to the windshield and, where fitted, to the side windows to the left and right of the driver</li><li>• System must switch between heater and defroster positions and fan must blow sufficiently at each speed</li></ul>
Windshield Wipers and Washers	<p>Windshield washer system must function in accordance with the manufacturer's specifications</p> <ul style="list-style-type: none"><li>• Each wiper arm and blade assembly must sweep the area specified by the manufacturer and provide effective clearing of the windshield</li></ul>
Instrument Panel	<ul style="list-style-type: none"><li>• No warning lights present after the start up cycle has completed</li><li>• Indicator lights must work for signals, hazards, and high beams</li><li>• Gauges and switches must be in normal operating ranges and/or positions</li></ul>
Horns	<ul style="list-style-type: none"><li>• Proper operation of both the air and electric horn</li></ul>

# Trip Inspections Cont.

## Interior Inspection continued

Component	Inspection Points
Brake Pedal	<ul style="list-style-type: none"><li>• Brake pedal pad or anti-skid surface is secure and does not have excessive wear (where equipped)</li><li>• Moderate foot force is maintained when pedal is depressed for 10 seconds</li><li>• Total pedal travel does not exceed 80% of the total available travel when heavy force is applied</li><li>• The brake releases immediately when pressure is released from the pedal</li></ul>
Accelerator Pedal	<ul style="list-style-type: none"><li>• With engine idling, depress the pedal and release, should be no binding or sticking</li></ul>
Clutch Pedal	<ul style="list-style-type: none"><li>• Check for free play and the amount of travel</li><li>• Clutch brake engages when fully depressed</li></ul>

# Trip Inspections Cont.

## Interior Inspection continued

Component	Inspection Points
Parking and Service Brakes	<ul style="list-style-type: none"><li>• When fully applied and not held by foot or hand force or by air pressure, the parking brake must hold the vehicle stationary against the engine momentarily while the vehicle is operated in reverse gear and low forward gear at a light throttle setting</li><li>• When service brakes are applied by either foot or hand force, it must stop the vehicle when the vehicle is operated in reverse gear and forward gear</li></ul>
Seats	<ul style="list-style-type: none"><li>• Securely mounted and properly adjusted</li><li>• Cushion or padding are not missing, torn or badly worn</li><li>• Seatbelts fasten and unfasten properly, no rips or tears, and properly secured to vehicle</li></ul>
Emergency Equipment	<ul style="list-style-type: none"><li>• Fire extinguisher must be present in commercial vehicles wider than 2,060 mm, within reach of the driver, secure and properly charged</li><li>• Minimum of three flares/triangles must be present if vehicle is wider than 2,060 mm and is being operated outside corporate limits of an urban municipality</li></ul>

# Schedule 1 – Truck, Tractor & Trailer

1. Air brake system
Defects <ul style="list-style-type: none"> <li>audible air leak</li> <li>slow air pressure build-up rate</li> </ul>
Major Defects <ul style="list-style-type: none"> <li>pushrod stroke of any brake exceeds the adjustment limit</li> <li>air loss rate exceeds the prescribed limit inoperative towing vehicle (tractor) protection system</li> <li>low air warning system fails or system is activated</li> <li>inoperative service, parking or emergency brake</li> </ul>
2. Cab
Defect <ul style="list-style-type: none"> <li>occupant compartment door fails to open</li> </ul>
Major Defect <ul style="list-style-type: none"> <li>any cab or sleeper door fails to close securely</li> </ul>
3. Cargo securement
Defect <ul style="list-style-type: none"> <li>insecure or improper load covering (e.g. wrong type or flapping in the wind)</li> </ul>
Major Defects <ul style="list-style-type: none"> <li>insecure cargo</li> <li>absence, failure, malfunction or deterioration of required cargo securement device or load covering</li> </ul>

4. Coupling devices
Defect <ul style="list-style-type: none"> <li>coupler or mounting has loose or missing fastener</li> </ul>
Major Defects <ul style="list-style-type: none"> <li>coupler is insecure or movement exceeds prescribed limit</li> <li>defective, incorrect or missing safety chain/cable</li> <li>coupling or locking mechanism is damaged or fails to lock</li> </ul>
5. Dangerous goods
Major Defect <ul style="list-style-type: none"> <li>dangerous goods requirements not met</li> </ul>
6. Driver controls
Defect <ul style="list-style-type: none"> <li>accelerator pedal, clutch, gauges, audible and visual indicators or instruments fail to function properly</li> <li>air leak in air suspension system</li> <li>broken spring leaf</li> <li>c)suspension fastener is loose, missing or broken</li> </ul>
Major defects <ul style="list-style-type: none"> <li>damaged or deflated air bag [patched, cut, bruised, cracked to braid, mounted insecurely]</li> <li>cracked or broken main spring leaf or more than one broken spring leaf</li> <li>part of spring leaf or suspension is missing, shifted out of place or in contact with another vehicle component</li> <li>loose U-bolt</li> </ul>

7. Driver seat
Defect <ul style="list-style-type: none"> <li>seat is damaged or fails to remain in set position</li> </ul>
Major defect <ul style="list-style-type: none"> <li>seatbelt or tether belt is insecure, missing or malfunctions</li> </ul>
8. Electric brake system
Defect <ul style="list-style-type: none"> <li>Loose or insecure wiring or electrical connection</li> </ul>
Major Defects <ul style="list-style-type: none"> <li>Inoperative breakaway device</li> <li>Inoperative brake</li> </ul>
9. Emergency equipment and safety devices
Defect <ul style="list-style-type: none"> <li>emergency equipment is missing, damaged or defective or expired</li> </ul>
10. Exhaust system
Defect <ul style="list-style-type: none"> <li>exhaust leak</li> </ul>
Major Defect <ul style="list-style-type: none"> <li>leak that causes exhaust gas to enter the occupant compartment</li> </ul>
11. Frame and cargo body
Defect <ul style="list-style-type: none"> <li>Damaged frame or cargo body.</li> </ul>
Major Defect <ul style="list-style-type: none"> <li>Visibly shifted, cracked, collapsing or sagging frame member(s).</li> </ul>

# Schedule 1 – Truck, Tractor & Trailer

<b>12. Fuel system</b>
Defect
<ul style="list-style-type: none"> <li>missing fuel tank cap</li> </ul>
Major Defects
<ul style="list-style-type: none"> <li>insecure fuel tank</li> <li>dripping fuel leak</li> </ul>
<b>13. General</b>
Major defect
<ul style="list-style-type: none"> <li>serious damage or deterioration that is noticeable and may affect the vehicle's safe operation</li> </ul>
<b>14. Glass and mirrors</b>
Defects
<ul style="list-style-type: none"> <li>required mirror or window glass fails to provide the required view to the driver as a result of being cracked, broken, damaged, missing or maladjusted</li> <li>required mirror or glass has broken or damaged attachments onto vehicle body</li> </ul>
<b>15. Heater/defroster</b>
Defect
<ul style="list-style-type: none"> <li>control or system failure</li> </ul>
Major Defect:
<ul style="list-style-type: none"> <li>defroster fails to provide unobstructed view through the windshield</li> </ul>
<b>16. Horn</b>
Defect
<ul style="list-style-type: none"> <li>vehicle has no operative horn</li> </ul>

<b>17. Hydraulic brake system</b>
Defect
<ul style="list-style-type: none"> <li>Brake fluid level is below indicated minimum level.</li> </ul>
Major Defects
<ul style="list-style-type: none"> <li>Parking brake is inoperative</li> <li>Brake boost or power assist is inoperative.</li> <li>Brake fluid leak.</li> <li>Brake pedal fade or insufficient brake pedal reserve.</li> <li>Activated (other than ABS) warning device.</li> <li>Brake fluid reservoir is less than ¼ full.</li> </ul>
<b>18. Lamps and reflectors</b>
Defect
<ul style="list-style-type: none"> <li>Required lamp does not function as intended.</li> <li>Required reflector is missing or partially missing.</li> </ul>
Major Defects - When use of lamp is required
<ul style="list-style-type: none"> <li>failure of both low-beam headlamps</li> <li>failure of both rearmost tail lamps</li> </ul>
Major Defects - at all times
<ul style="list-style-type: none"> <li>failure of a rearmost turn-indicator lamp</li> <li>failure of both rearmost brake lamps</li> </ul>
<b>19. Steering</b>
Defect
<ul style="list-style-type: none"> <li>steering wheel lash (free-play) is greater than normal</li> </ul>

Major Defects
<ul style="list-style-type: none"> <li>steering wheel is insecure, or does not respond normally</li> <li>steering wheel lash (free-play)</li> </ul>
<b>20. Suspension system</b>
Defects
<ul style="list-style-type: none"> <li>air leak in air suspension system</li> <li>broken spring leaf</li> <li>c)suspension fastener is loose, missing or broken</li> </ul>
Major defects
<ul style="list-style-type: none"> <li>damaged or deflated air bag [patched, cut, bruised, cracked to braid, mounted insecurely]</li> <li>cracked or broken main spring leaf or more than one broken spring leaf</li> <li>part of spring leaf or suspension is missing, shifted out of place or in contact with another vehicle component</li> <li>loose U-bolt</li> </ul>
<b>21. Tires</b>
Defects
<ul style="list-style-type: none"> <li>damaged tread or sidewall of tire</li> <li>tire leaking (if leak can be felt or heard, tire is to be treated as flat)</li> </ul>
Major defects
<ul style="list-style-type: none"> <li>flat tire</li> <li>tire tread depth is less than wear limit</li> <li>tire is in contact with another tire or any vehicle component other than mud-flap</li> <li>tire is marked "Not for highway use"</li> <li>tire has exposed cords in the tread or outer side wall area</li> </ul>



# Schedule 1 – Truck, Tractor & Trailer

<b>22. Wheels, hubs and fasteners</b>
<p>Defects</p> <ul style="list-style-type: none"> <li>hub oil below minimum level (When fitted with sight glass)</li> <li>leaking wheel seal</li> </ul> <p>Major Defects</p> <ul style="list-style-type: none"> <li>wheel has loose, missing or ineffective fastener</li> <li>damaged, cracked or broken wheel, rim or attaching part</li> <li>evidence of imminent wheel, hub or bearing failure</li> </ul>
<b>23. Windshield wiper/washer</b>
<p>Defects</p> <ul style="list-style-type: none"> <li>control or system malfunction</li> <li>wiper blade damaged, missing or fails to adequately clear driver's field of vision</li> </ul> <p>Major Defects (<u>when necessary for prevailing weather conditions</u>):</p> <ul style="list-style-type: none"> <li>wiper or washer fails to adequately clear driver's field of vision in area swept by driver's side wiper</li> </ul>

**SAMPLE TRUCK/TRAILER TRIP INSPECTION REPORT**

Time:	Date:
Carrier Name (as on registration):	
Plate Number(s) and Jurisdiction(s)	
Truck:	Lead Trailer:
Rear Trailer:	Other:
Location of Inspection (municipality or location on highway):	
<input type="checkbox"/> Odometer Reading:	OR <input type="checkbox"/> Hubometer Reading:

I performed an inspection of the vehicle noted above using the criteria set out in Schedule 1 of Part 2, NSC Standard 13 and as per sections 10(4) and 10(10) of Alberta's *Commercial Vehicle Safety Regulation*, AR 121/2009 and report the following:

No defects were found.

Defects were detected (check applicable):

Inspected	Defect	Major Defect	Vehicle Plate	Details of Defect (if any)
Air Brake System	<input type="checkbox"/>	<input type="checkbox"/>		
Cab	<input type="checkbox"/>	<input type="checkbox"/>		
Cargo Securement	<input type="checkbox"/>	<input type="checkbox"/>		
Coupling Device	<input type="checkbox"/>	<input type="checkbox"/>		
Dangerous Goods	<input type="checkbox"/>	<input type="checkbox"/>		
Driver Controls	<input type="checkbox"/>	<input type="checkbox"/>		
Driver Seat	<input type="checkbox"/>	<input type="checkbox"/>		
Electric Brake System	<input type="checkbox"/>	<input type="checkbox"/>		
Emergency Equipment and Safety Devices	<input type="checkbox"/>	<input type="checkbox"/>		
Exhaust System	<input type="checkbox"/>	<input type="checkbox"/>		
Frame and Cargo Body	<input type="checkbox"/>	<input type="checkbox"/>		
Fuel System	<input type="checkbox"/>	<input type="checkbox"/>		
General	<input type="checkbox"/>	<input type="checkbox"/>		

Complete the Trip Inspection Report



# En Route Check Stop Inspections

- Rest stops
- Highway vs. City
- Vehicle inspections
- NSC requirement and Carrier policy

# Vehicle Inspection Stations

- All Commercial vehicles over 4500 kg
- Lights = Law
- When Loaded
- When Empty
- Light Board

# Pre-Trip Inspection

- Before you start
- Requirements



# Exterior Inspection - *Circle check*

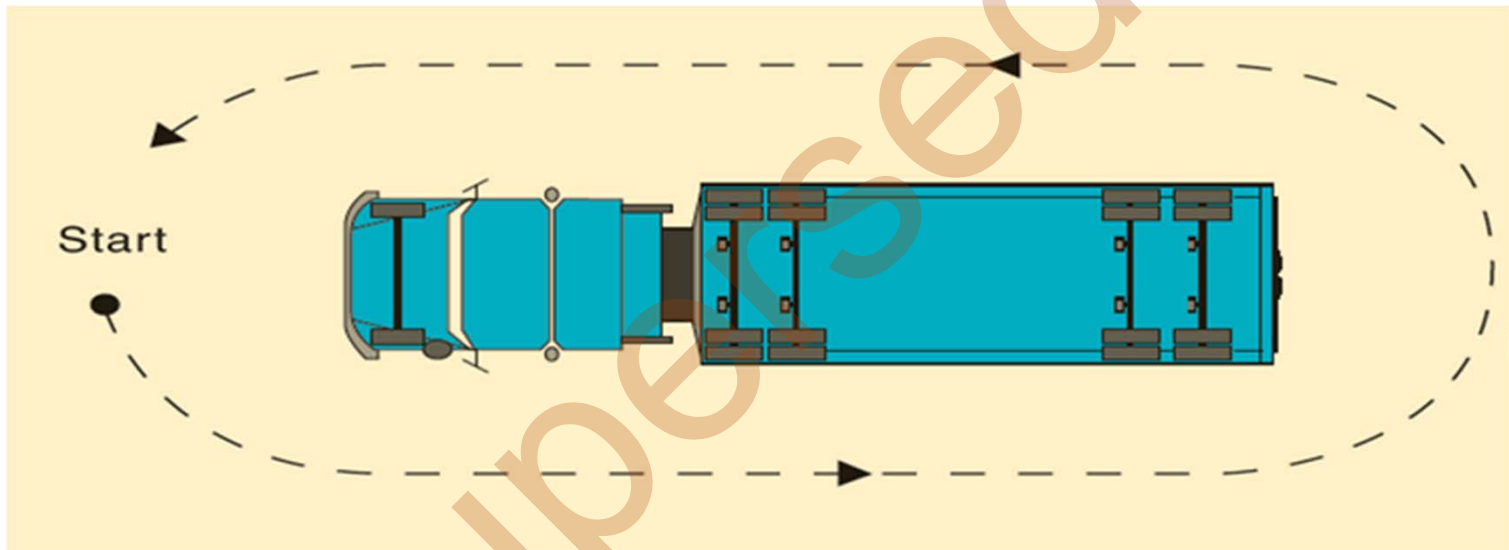

# Pre-Trip Inspection Cont.

Front of the vehicle

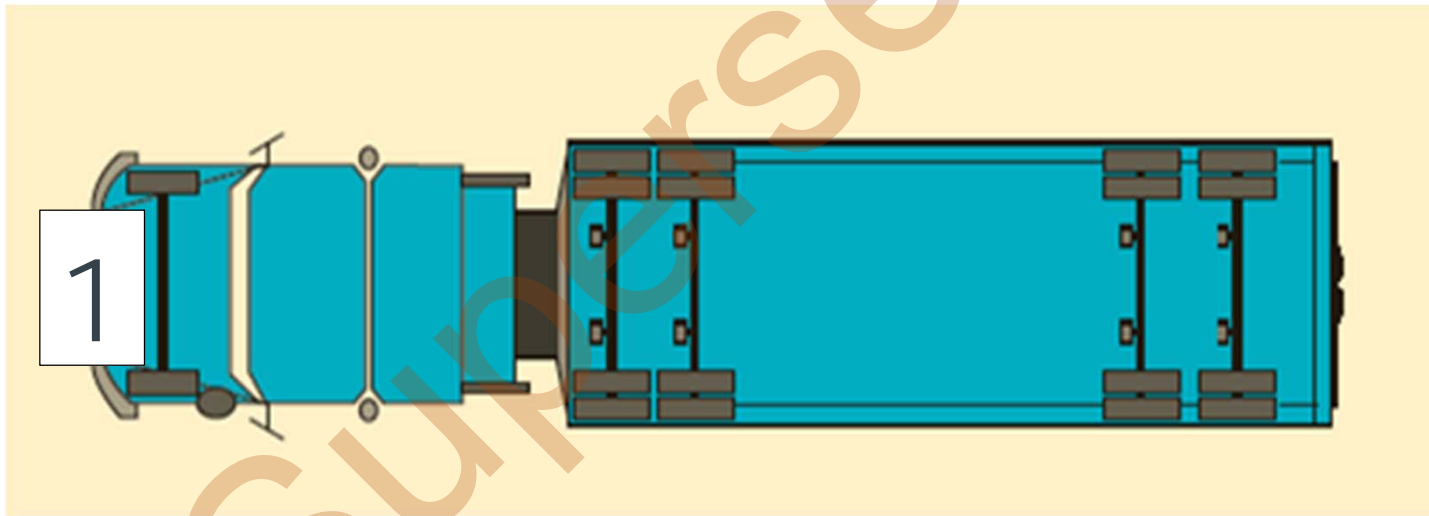

## Pre-Trip Inspection Cont.

- 3-point contact method
- Interior of cab
- What to look for
- What to adjust
- The how's and why's

## Pre-Trip Inspection Cont.

- Vehicle documents
- Engine start up
- What to listen for
- What to watch for
- Why



## Pre-Trip Inspection Cont.

- Air pressure gauge
- Oil pressure warning light
- Alternator/Generator warning light
- Ammeter Gauge (instead of alternator)

## Pre-Trip Inspection Cont.

- Service brake warning light
- Water temperature gauge or warning light
- Fuel gauge
- Light indicators

## Pre-Trip Inspection Cont.

- Interior Emergency Equipment
- Interior Components and Systems

## Pre-Trip Inspection Cont.

- Air Brake System
- What to check
- How to know it is in proper working order

# Pre-Trip Inspection Cont.

Driver side of vehicle

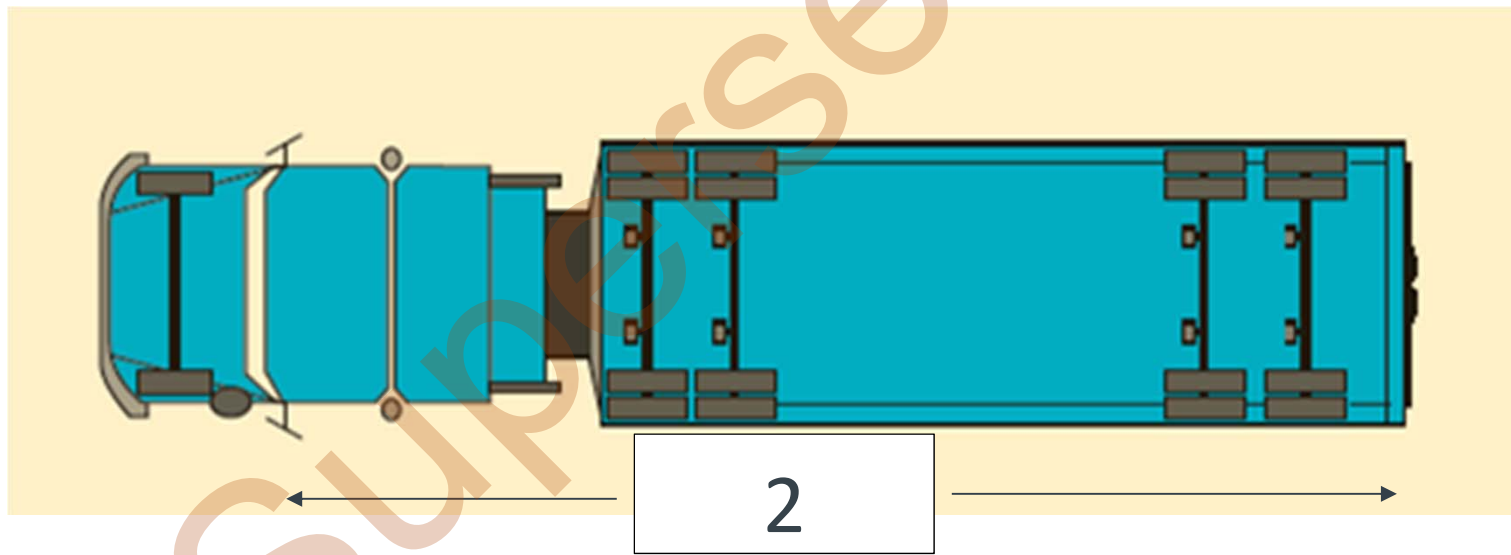

# Pre-Trip Inspection Cont.

Rear of the vehicle

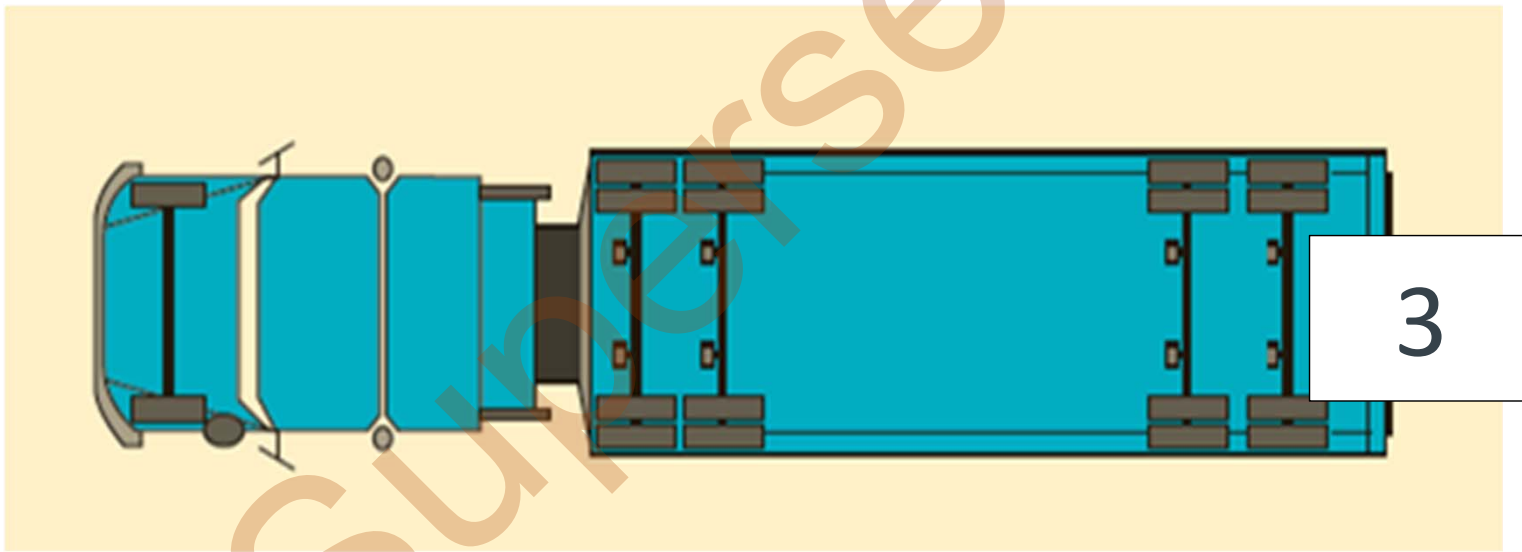

# Pre-Trip Inspection Cont.

Passenger side of vehicle

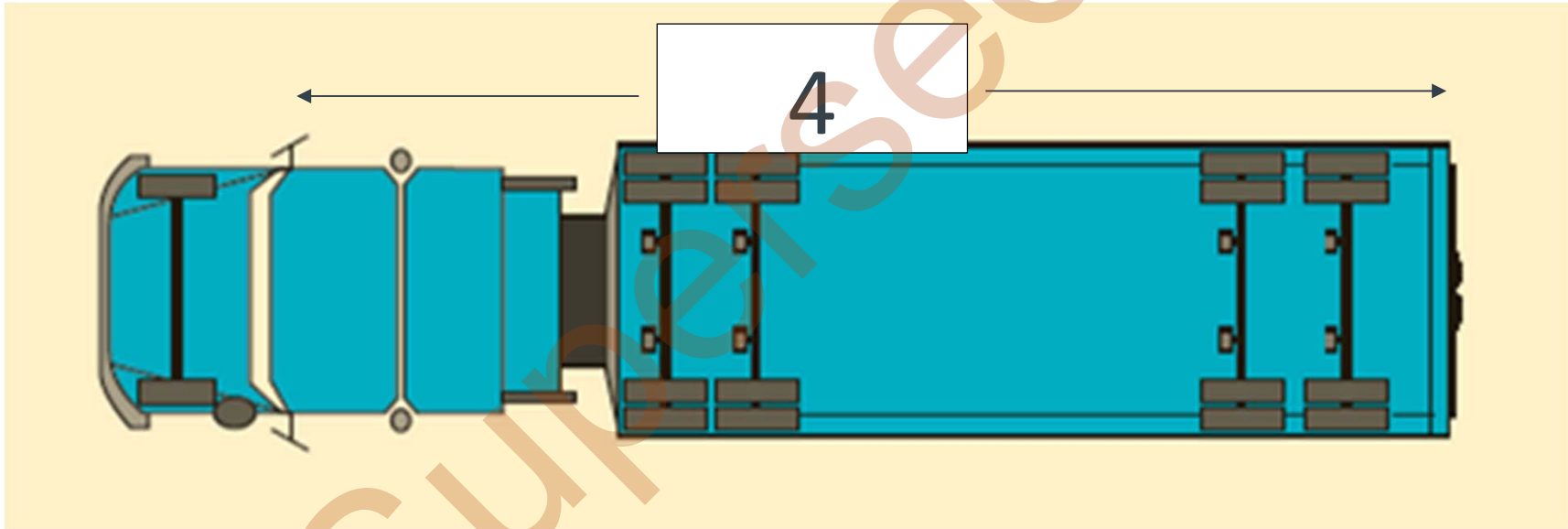

## Pre-Trip Inspection Cont.

- Cargo Securement system
- What to look for
- How to correct if needed



# Air Brake Trip Inspection

- Visual inspection and wheel chocks
- Tractor protection system
- Park control valve
- Supply circuit
- Air system leaks
- Service brake response

# Post-Trip Inspection

- End of shift
- Include any defects from during the trip
- Saves time and frustration later
- Practical application throughout the training

## Summary

- Compliance with vehicle inspections
- Inspection stations
- Pre-trip
- En route inspections
- Post-trip inspections

# Review

Who is required to stop at a vehicle inspection station?

# Review - Answer

All Commercial vehicles  
Over 4,500 kg

# Review

How long is a Schedule 1  
valid?

# Review - Answer

24 Hours

Alberta

---

# Review

Which of the Pre, Post and En route trip inspections need to be documented



# Review - Answer

All of them

## Review

What is the method you need to use when you enter, exit or climb on and off of the truck?

## Review - Answer

3-POINT CONTACT

2 HANDS, 1 FOOT

OR

2 FEET, 1 HAND

Alberta

---

# Review

When you start the engine what gauge do you want to pay attention to first?

# Review - Answer

Oil pressure

Alberta

---

# Questions?

---



Supersedes

# Module 8 – Hours of Service Compliance

Superseded

# Purpose

## Module 8:

- ✓ Federal and Provincial Legislation
- ✓ How to record and maintain daily log books
- ✓ Driver responsibilities and requirements
- ✓ Employer responsibilities and requirements
- ✓ Importance of rest for collision avoidance
- ✓ Exemptions for hours of services
- ✓ Consequences of violations

Module Hours  
In-Class

3 hours

### Delivery

- ✓ Lecture, pairs, group, demo, etc.

Assess

30 min

- ✓ Practice, performance, etc.

Alberta



# Legislation

- Why are they regulated
- Federal
- Provincial

Superseded

---

# Provincial Legislation

Alberta  
Legislation

Applicable  
to:

## Provincial Operating Status

A truck, tractor, or trailer or any combination of these vehicles registered for a weight of 11,794 kilograms or greater

A commercial passenger vehicle with an original manufacturer's seating capacity of 11 or more persons including the driver

Not  
applicable  
to:

## Does Not Apply

- Passenger vehicles weighing less than 11,794kgs
- Emergency Vehicles
- Commercial vehicles transporting agricultural products
- Urban transit buses
- Recreational vehicles
- Exempted vehicles per the Registrar
- Etc.

Alberta

# Daily Log: Duty Statuses

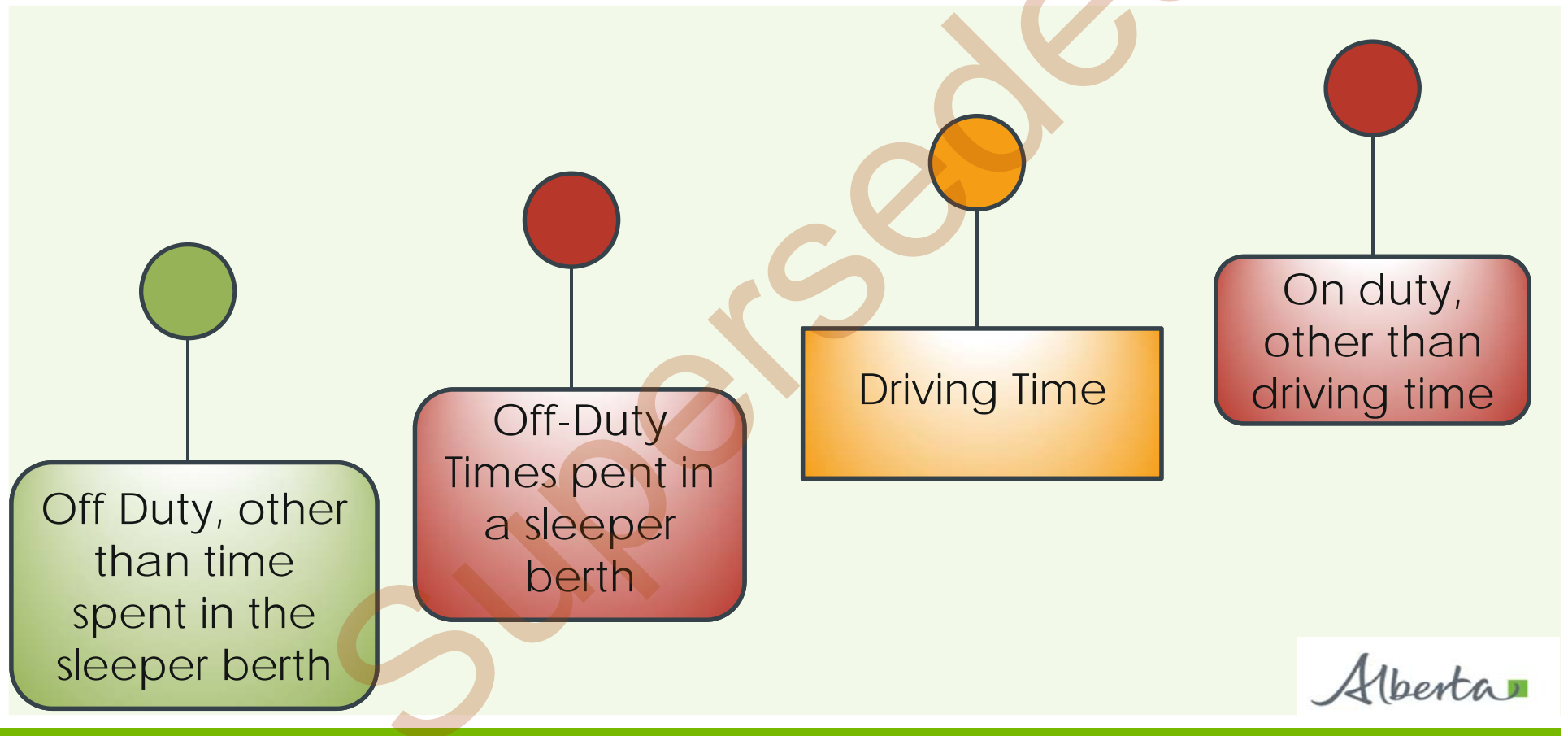

# Daily Log: Completing the daily log

Driver duty statuses are recorded on the grid. This is completed using a pen and ruler or a straight edge. Time marker on the grid is broken down as follows:

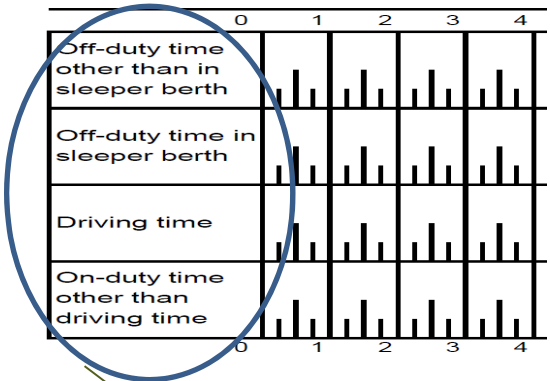

These are the four types of duty status. Each duty status is demarcated into rows by horizontal lines. Time spent in each of the duty is recorded on each horizontal row

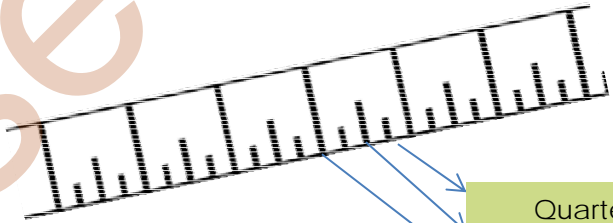

Quarter hour (15 minutes)  
Half hour (30 minutes)  
Actual hour

Time is recorded by drawing a horizontal line that corresponds to the actual time up to the nearest Half-hour (30 minutes) or quarter-hour (15 minutes)

# Daily Log

## Must be Completed as follows:

- ✓ Enter required information accurately and legibly
- ✓ Maintain daily log current to the last change of duty status
- ✓ Keep copies of documents received during the trip
- ✓ Deliver the daily log to employer within 20 days
- ✓ Keep a copy of each daily log for at least 6 months

## Start of the Day:

- ✓ Starting odometer reading
- ✓ Unit or licence plate number
- ✓ The name of the carrier for whom the driver worked during the work day
- ✓ The name of the driver and co-driver
- ✓ Time commencement
- ✓ Location commencement

Alberta

# Daily Log

## During the Day:

- ✓ Completed on a graph grid
- ✓ At each duty status change:
  - ❑ Draw a continuous line between time markers
  - ❑ Record the location and province/state
  - ❑ Record the fueling location with amount

## End of the Day:

- ✓ Total number of kilometers/miles driven
- ✓ Total number of hours vehicle has travelled (co-driver)
- ✓ Record the total number of hours of time off duty, driving time, and on-duty other than driving time
- ✓ Sign the log

# On-duty Status

- Period that begins when a driver begins work or when a driver is required by the employer/carrier to be available at work
  - The on-duty hours consisting of “driving” and “on-duty not driving” time

# On-duty Status (cont)

## Work shift



No driving after 13 hours driving  
in a work shift





# On-duty – Work shift

- For example

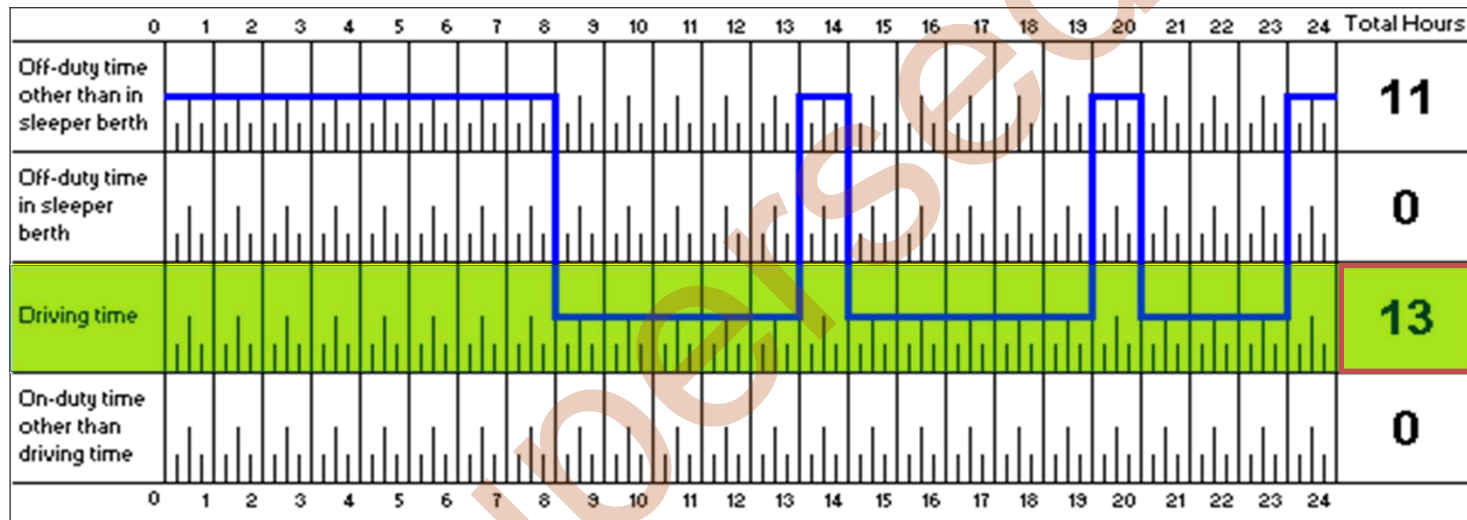

# On-duty – Work shift

No Driving after 15 hours on duty in a work shift



For example

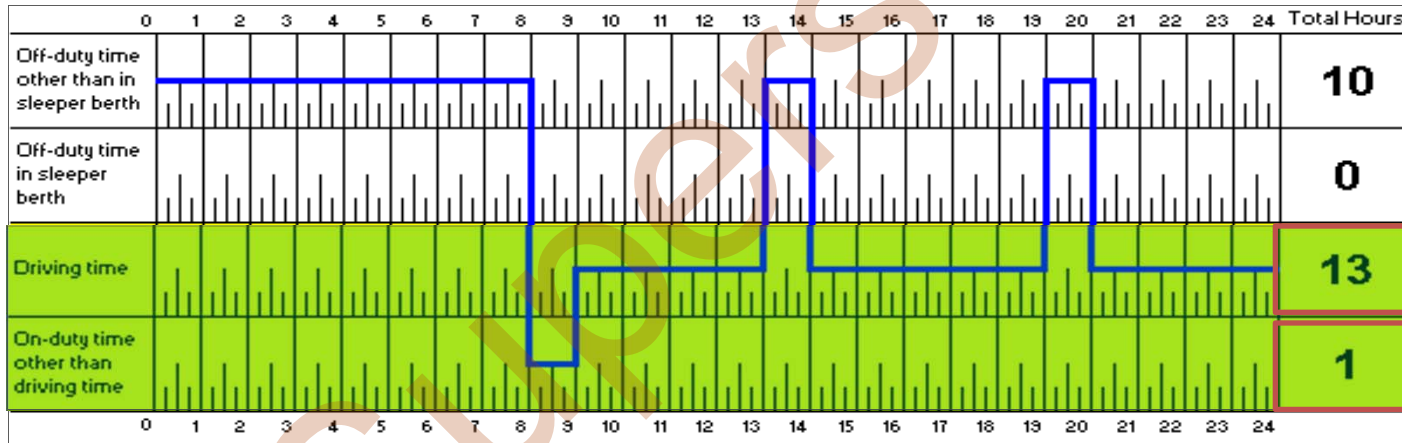

# Time breaks

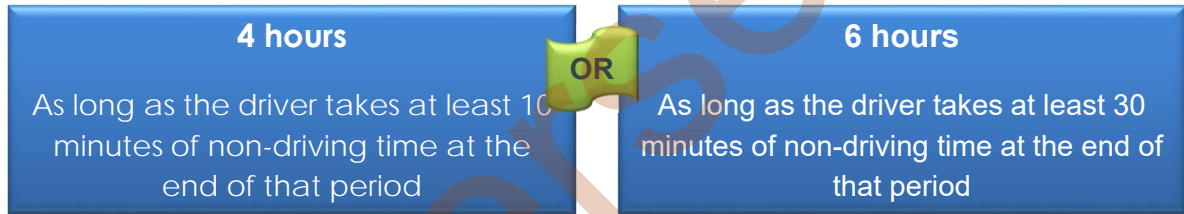

# Off-Duty Time

- Any time where the vehicle is at a stop, and for the duration of the stop, the driver is at liberty to pursue own activities up to 75 km in a day only when:
  - There are no passengers
  - No trailer is being towed
  - No work of any sort is being done for the carrier
  - The starting and ending odometer readings are recorded in the driver's daily log

# Off-duty

For example



# Splitting Sleeper Berth Time

---

- If the vehicle is equipped with a sleeper berth, driver may rest in the sleeper berth
- 2 sleeper berth periods should be at least 2 hours
- The combined sleeper berth period to make at least 8 hours

# Sleeper Berth Time

Example of an acceptable use of a sleeper berth

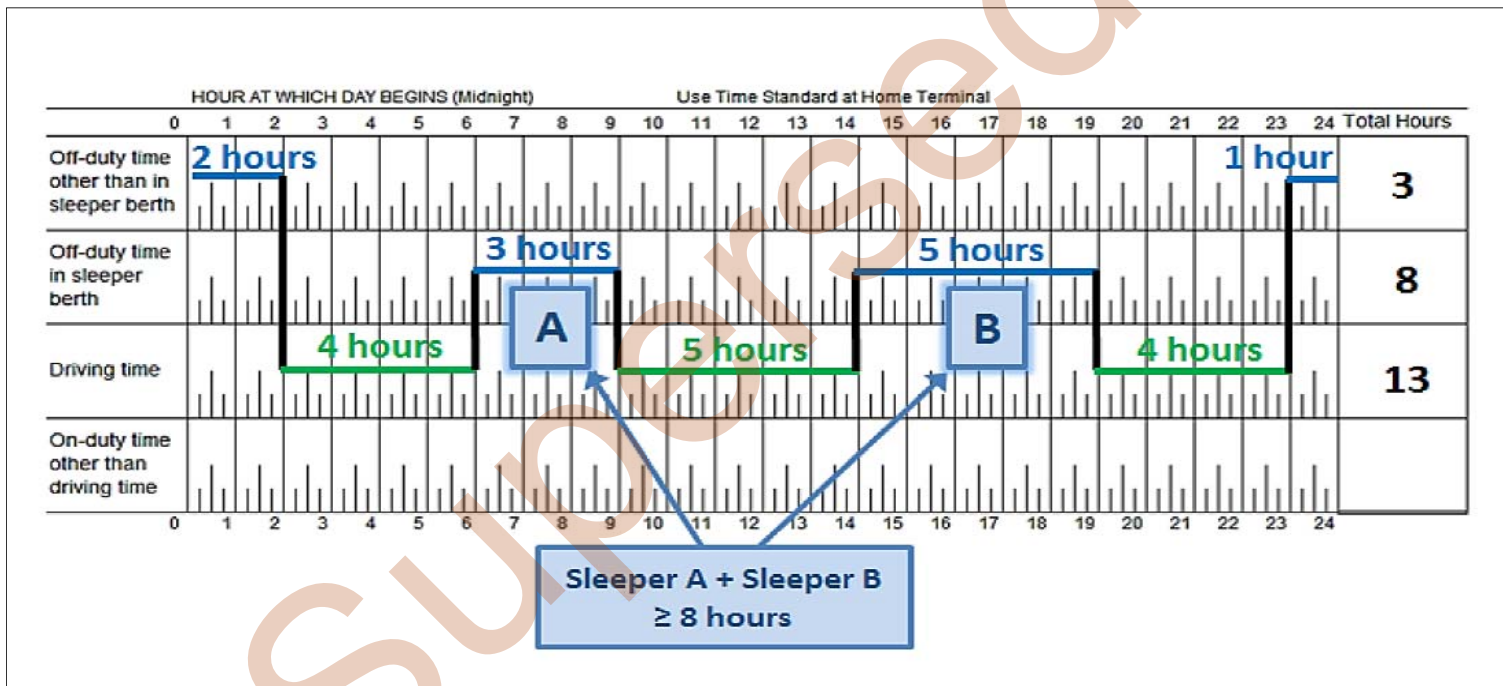

# Daily Log: Exemptions

## Radius Record Partial Exemption



### Not required to be done if ALL apply:

- The driver does not operate outside of a 160km radius from the home terminal.
- The driver starts and ends the work shift at the same place and does not exceed 15 hours
- Maintains time records showing the start and end of the driver's work shift for six months.



# Daily Log

## Radius Record Partial Exemption - continue

- If one or more of those four conditions cease to exist, the driver shall:
  - Commence keeping a daily log.
  - Record in the daily log the total number of hours on duty accumulated by the driver during the 7 days immediately preceding the day on which that condition ceased to exist.

Here is an example of a radius record

Carrier Name and Address:				
DRIVER'S TIME RECORD				
Day of Month	On-Duty Time		Description i.e. Field Trip, Service Trip, Training, Teaching, etc.	Unit #
	Start	End		
1				
2				
3				
4				
5				
6				
7				
8				
9				
10				
11				
12				
13				
14				
15				

Driver's Name (Print): \_\_\_\_\_ Month: \_\_\_\_\_ Year: \_\_\_\_\_

Driver's Signature: \_\_\_\_\_

**Note:** All calendar days must be accounted for. If you had no on-duty time for the period covered by this time record, please write "OFF" over the above dates and submit this time record as specified below.

THIS TIME RECORD MUST BE SUBMITTED TO THE TRANSPORTATION DEPARTMENT IMMEDIATELY FOLLOWING THE 1<sup>ST</sup> OF THIS MONTH



# Daily Log: Exemptions

## Adverse Driving Conditions



### Adverse Conditions may include:

- Snow, sleet, fog or smoke obscuring a person's vision
- A highway covered with snow or ice
- Physical circumstances, other than snow or ice, that make the highway or driving unsafe

Daily Driving  
Limit

13 hours + 2 hours  
= 15 hours

OR

Daily On-Duty  
Limit

15 hours + 2 hours  
= 17 hours

Alberta

# Daily Log: Exemptions

## Emergency



### Emergency cases may include:

- Sudden, unexpected situation that require immediate action
- Safety or security of people, goods, or vehicle is at risk
- **Does not** include shipper's demands, driver's desire to get home, loading/unloading delays or shortage of drivers

# Other Legislative Requirements



- Automatic On-Board Recording Device
- Production of Logs & Supporting Documents
- Distribution and Keeping of Daily Logs
- Retention of Records by Carrier and drivers
- Violations
- Inspections
- Tampering with Daily Logs
- Disciplinary Action and Enforcement

# Other Legislative Requirements

## Automatic On-Board Recording Device

According to the *Drivers' Hours of Service Regulation*, "automatic on-board recording device" means any electric, electronic or electro-mechanical device that accurately and automatically does at least the following:

(i) records

(A) the driving time and the time on duty of drivers for each day that the device is in operation,

(B) the remaining driving time and on duty time that a driver may use, and

(C) the sequential changes in duty status and the time those changes occurred;

(ii) indicates and records the time at which the device is disconnected;

(iii) records the times that the vehicle is in motion;

(iv) displays or prints out, at the request of the driver, at least the information referred to in subclause (i);

# Other Legislative Requirements

## ● Production of Logs & Supporting Documents

- Driver must produce daily logs for the current day and the previous 2 days.
- Driver must produce any supporting documents or relevant records for the current trip (receipts, bill of lading, inspection reports, etc.).

# Other Legislative Requirements



## Distribution and Keeping of Daily Logs

- Driver shall forward a copy of the daily log for that day to each carrier by whom the driver was employed or otherwise engaged
- Driver shall, within 20 days from the day that a daily log is completed, forward the original of the daily log to the home terminal of the driver or to the principal place of business of the carrier by whom the driver was employed or otherwise engaged

# Other Legislative Requirements

## ● Retention of Records by Carrier and Drivers

- Retention of duplicates of all daily log books in a neat and orderly manner
- Produce records within 7 days of request by a peace officer
- A driver is required to submit each completed log to the carrier within 20 days of being produced
- If a driver is following provincial hours of service laws they must also keep a personal copy of their hours of service records.
- Information about log book records is available online in our education manual or at: [www.transportation.alberta.ca/675.htm](http://www.transportation.alberta.ca/675.htm)

Alberta



## Other Legislative Requirements

### Violation

- Exceeding driving time limit
- Failure to meet off-duty time requirement (e.g., complete 8 consecutive hours off duty).
- Unable or refuses to produce his/her log book (if not under radius exemption).
  - Driver may be prevented from driving until the required documentations have been presented.
- Evidences that the driver has tampered with the logbook

## Other Legislative Requirements



### Inspections

- According to Section 18 of the Drivers' Hours of Service Regulation, A peace officer may enter any facility or vehicle for the purpose of determining whether a carrier and a driver have complied with this Regulation.

## Other Legislative Requirements

### Tampering with Daily Logs

- No driver shall:
  - Keep more than one daily log;
  - Record inaccurate information on a daily log; or
  - Falsify, mutilate, or deface a daily log or supporting documents

## Other Legislative Requirements



### Disciplinary Action and Enforcement

- If a driver has been prohibited from driving, they will not be permitted to drive a vehicle until the driver:
  - Has had the time off duty as required under the regulation; and
  - Has met all on-duty and time break requirements under the regulation.

## Federal legislation - On and Off Duty

- Definition of On-Duty
- Definition of Off-Duty

Superseded



## Sleeper Berth Periods

- How this can be split into shorter periods
- How can it be split when team driving

# Daily Limits

- In a 24 hour period

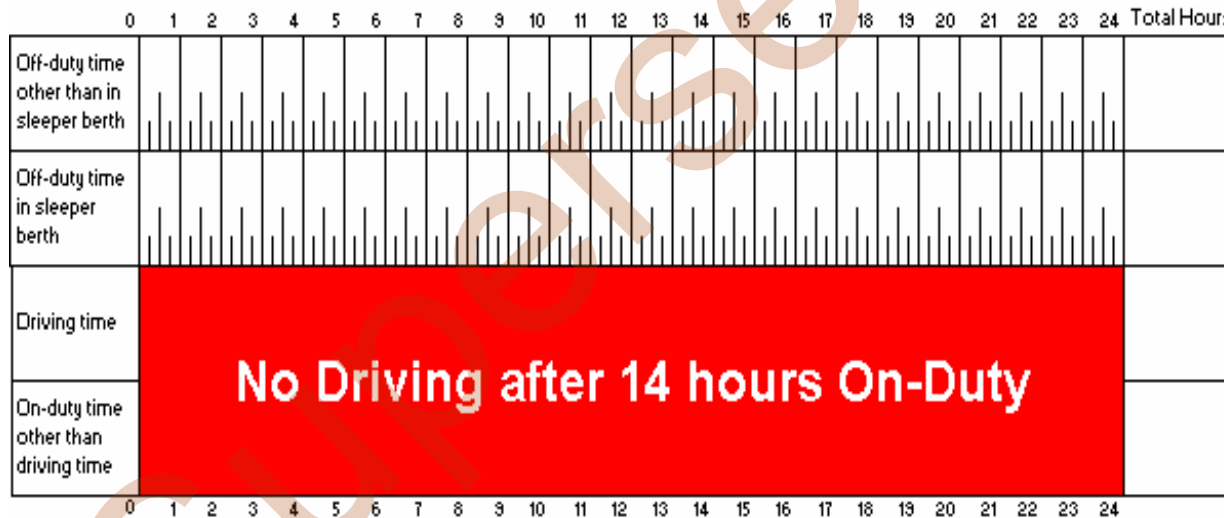

# Shift Limits

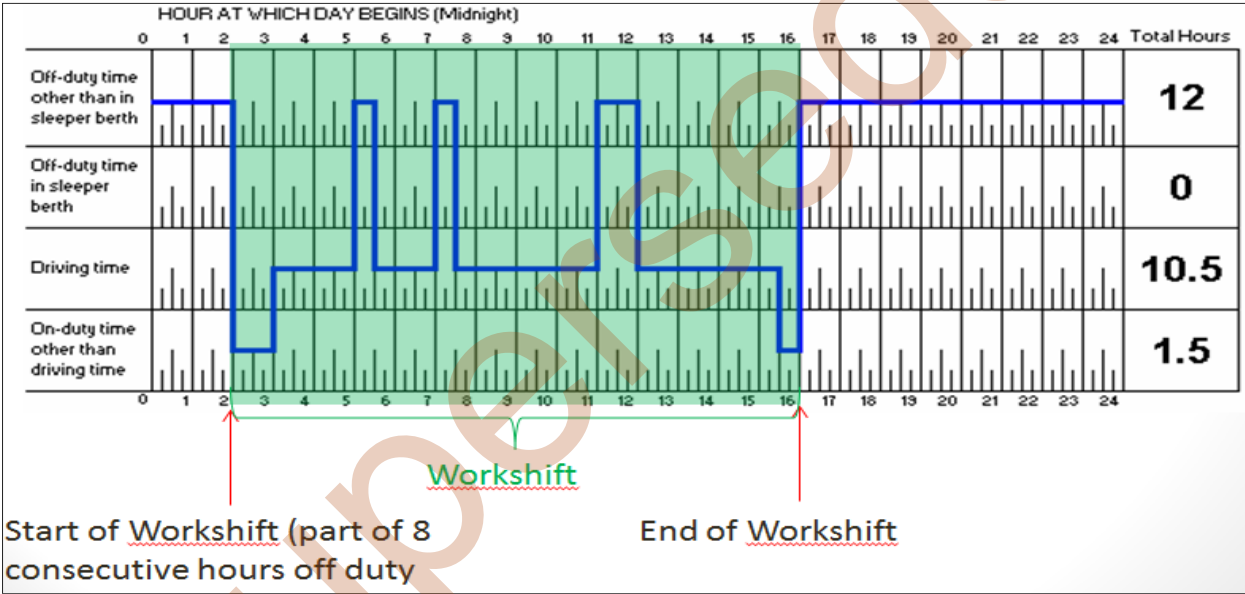





## Cycle Limits

- Cycle 1 Hours
- Cycle 2 Hours

Superseded



# Mandatory 24 Hours Off Duty

Sunday	Monday	Tuesday	Wednesday	Thursday	Friday	Saturday
 24 hours off-duty	On Duty	On Duty	On Duty	On Duty	On Duty	On Duty
On Duty	On Duty	On Duty	On Duty	On Duty	On Duty	On Duty
On Duty	 24 hours off-duty	On Duty	On Duty	On Duty	On Duty	On Duty

# Off Duty Time Deferrals

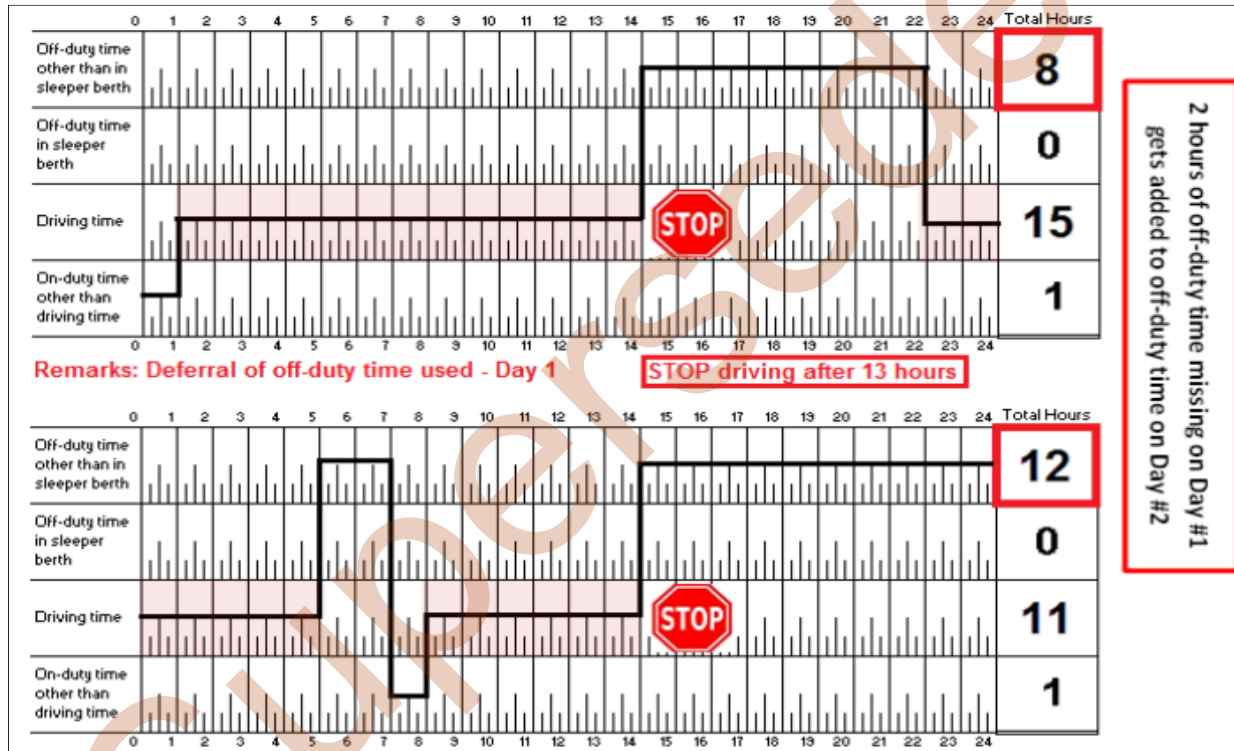

## Emergencies and Adverse Conditions

- When you can extend hours of service
- How can this be done while still complying with regulation

# Daily Logs

- Information required
- How to fill in the grid log

**SCHEDULE 2 (Section 1 and subsection 82(2))**

**DUTY STATUS**

NAME / NOM \_\_\_\_\_ DATE \_\_\_\_\_

Cycle 1 (7 days — 7 jours)  OR / OU Cycle 2 (14 days — 14 jours)

(Hour at which day begins — Use local time at home terminal)  
(Heure à laquelle la journée commence — Utiliser l'heure locale à la gare d'attache)

	0	1	2	3	4	5	6	7	8	9	10	11	12	13	14	15	16	17	18	19	20	21	22	23	24	Total Hours Total des heures	
1. Off-duty time other than time spent in a sleeper berth / Heures de repos, à l'exclusion du temps passé dans une couchette																											
2. Off-duty time spent in a sleeper berth / Heures de repos passées dans une couchette																											
3. Driving time / Heures de conduite																											
4. On-duty time other than driving time / Heures de service, à l'exclusion des heures de conduite																											

Remarks / Observations \_\_\_\_\_

Total distance driven / Distance totale parcourue \_\_\_\_\_

Signature \_\_\_\_\_

Alberta

# Daily Logs Cont.

MOTOR VEHICLE OPERATOR'S DAILY LOG													Date: <u>JAN. 5-6, 2008</u>														
Motor Carrier: <u>ABC Transportation Inc.</u>											Odometer Finish																
Principal Place of Business: <u>1 Bay St Calgary, AB T8K 9X3</u>											Vehicle Plate or Unit #																
Home Terminal Address: <u>1 Bay St Calgary, AB T8K 9X3</u>											Cycle 1 (7 days) <input checked="" type="checkbox"/>	Cycle 2 (14 days)	Odometer Start														
													Total Distance Driven Today	<u>0</u> km													
HOUR AT WHICH DAY BEGINS (Midnight)													Use Time Standard at Home Terminal														
0	1	2	3	4	5	6	7	8	9	10	11	12	13	14	15	16	17	18	19	20	21	22	23	24	Total Hours		
Off-duty time other than in sleeper berth													24														
Off-duty time in sleeper berth													0														
Driving time													0														
On-duty time other than driving time													0														
													Total <u>24</u>														
REMARKS																											
DAILY DEFERRAL USED: Day 1 Day 2																											
Other Motor Carrier (Name & Address)													PERSONAL USE OF COMMERCIAL VEHICLE														
													Start Odometer						End Odometer								
Name of Co-Driver																											
PREVIOUS DAYS' TIME RECORDS																											
Previous Day (first = 1)													1	2	3	4	5	6	7	8	9	10	11	12	13	14	
Total Hours On-Duty																											
Total Hours Off-Duty																											
													PERSONAL USE OF COMMERCIAL VEHICLE														
													Bill Driver														
													Printed Name of Driver														
													Bill Driver														
													Signature of Driver (Certified True & Correct)														



# Onboard Recording Devices

- Electronic Log Books
- Requirements

Superseded



# Record Radius Record Exemption

## Examples of Record Radius

160 Kilometer Radius Record					
Driver name: _____ Date: _____					
Elected Cycle:					
<input type="checkbox"/> 1					
<input type="checkbox"/> 2					
Start Time	End Time	Off-Duty	Driving	On-Duty Not Driving	Remarks
<b>Total Hours</b>					



# Tampering

- Illegal
- Companies responsibility
- Driver responsible to sign and confirm all is accurate
- Could be a out of service penalty

## Penalties

- Convictions

- \$5,000.00

- \$25,000.00

Superseded



## Out of Service Violations

- Peace officers
- Can be pulled off the road
- Administrative penalties

# Summary

- Regulations
- Log book requirements
- Tampering and penalties

# Federal Legislation Review

Federal  
Legislation

## Daily Limit

During a day,  
a driver cannot drive:

- After having driven 13 hours
- After being on-duty for 14 hours

## Shift Limit

During a work shift,  
a driver cannot drive:

- After having driven 13 hours
- After being on-duty for 14 hours
- After 16 hours of time has elapsed since the conclusion of their most recent 8 hours of consecutive off-duty time

## Cycle Limit

Depending on the cycle,  
a driver cannot drive after  
accumulating:

- Cycle 1 - 70 hours of on-duty time in seven consecutive days; or
- Cycle 2 - 120 hours of on-duty time in 14 consecutive days.

## Off-Duty Time

A driver may defer a  
maximum of two hours if:

- Not part of the 8 hours
- Taken in 2 days is at least 20 hours
- Added to the 8 hours of off-duty time in the second day
- Total driving time in 2 days does not exceed 26 hours

Alberta

# Review

What is an acceptable form of log book?

# Review - Answer

Paper or Electronic

Alberta

---

# Review

What are the 4 status categories that are recorded on a log book?



# Review - Answer

On-Duty

Off-Duty

Sleeper Berth

On-duty Not Driving

Alberta

---

# Review

What are the cycles and  
how many hours are in  
each?

Superseded



## Review - Answer

Cycle 1:

70 hours of on-duty in 7 days

Cycle 2:

120 hours on-duty in 14 days

## Review

When can a driver defer hours of the off duty time to the following day?

## Review - Answer

If they are not splitting time off duty

or

Inclement weather

Alberta

# Review

What is the maximum hours that can be deferred?

# Review - Answer

2 Hours

Alberta

---

# Summary

- Hours of Service Regulations were developed to ensure driver's get opportunities for adequate rest.
- The Log is a legal document and tracks the driver's daily activity, therefore, all information should be recorded accurately and legibility.
- Log books must be retained for a minimum period of 6 months after the day on which they were recorded.



# Questions?

---



Superseded

# Module 9 – Cargo Securement and Loss Prevention

---

Superscripted

# Purpose

## Module 9:

- ✓ Importance of safe cargo securement
- ✓ The laws regarding cargo securement
- ✓ How to safely distribute cargo weight during loading

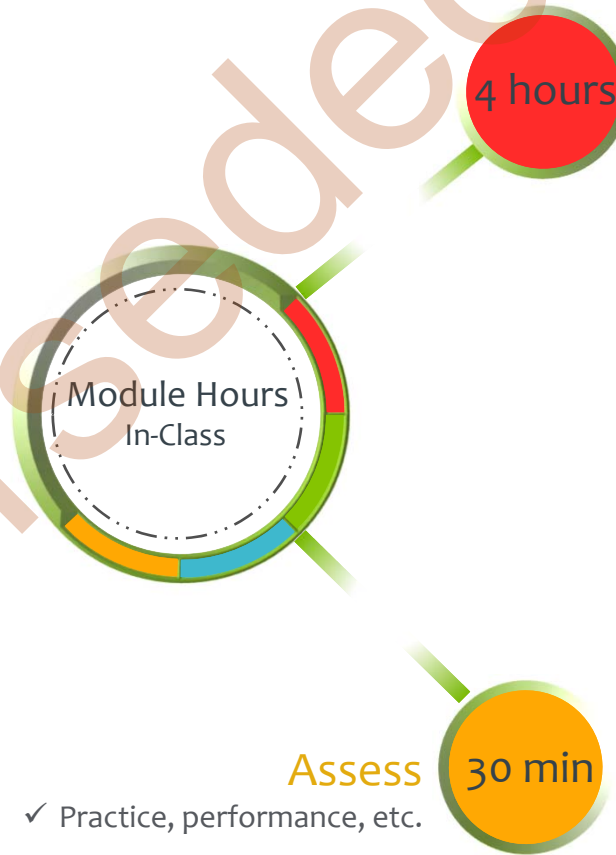

# Introduction

## Cargo pre-trip

- Visual check/walk around
- Power and hauling characteristics
- Weight of the cargo and distribution

## Cargo

- Reduce the chance of a collision caused by cargo shifting or falling
- The drivers responsibility

## Cargo Cont.

- Not properly secured can result in:
  - Loss of life
  - Loss of goods
  - Damage to cargo or vehicle
  - Collision with other road users
  - Injury to other road users
  - Fines and vehicle out of service

# North American Cargo Securement Standard

- Prior to operating the vehicle
- Securement of vehicle structure and equipment
- The cargo or any other object must not:
  - Interfere
  - Obstruct
  - Prevent

## Registered over 4500 kg

- Carrier and Driver responsibility
- Inspect the cargo
  - When & how often
- When you wouldn't need to secure cargo
- If it isn't secured properly



# Securement System

- Vehicle Structure
- Securing Devices
- Blocking and Bracing Equipment

# Securement Devices

## NSC Standard

- Working order
- Correct type for cargo
- Knots, damage, weakened
- Cracks or cuts
- Unfastened
- Specified amount of force

# Tiedowns

- Anchor points
- Proper function
- Working Load Limit
- Aggregate (combined) working load limits



## Tiedowns Cont.

- Unmarked and marked
- Rub rails



# Tiedowns Cont.

Minimum number of tiedowns

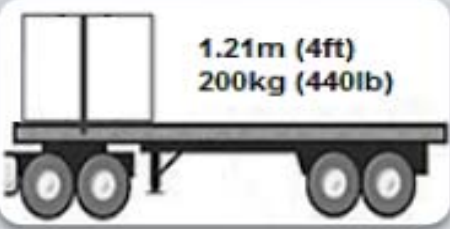
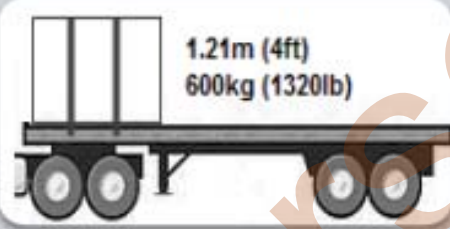
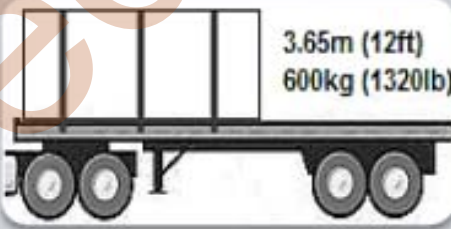
 <p>1.21m (4ft) 200kg (440lb)</p>	 <p>1.21m (4ft) 600kg (1320lb)</p>	 <p>3.65m (12ft) 600kg (1320lb)</p>
<p><b>1 Tie Down</b></p> <ul style="list-style-type: none"><li>- For cargo 1.52 metres or shorter and 500 kilograms or less in weight</li></ul>	<p><b>2 Tie Downs</b></p> <ul style="list-style-type: none"><li>- For cargo 1.52 metres or shorter and more than 500 kilograms</li><li>- For cargo greater than 1.52m in length but less than 3.04m, regardless of weight</li></ul>	<p><b>3+ Tie Downs</b></p> <ul style="list-style-type: none"><li>- For cargo longer than 3.04m</li></ul>

# Review

Who has the majority of responsibility when it comes to load securement?

# Review - Answer

THE DRIVER

Alberta

---

# Review

When must the cargo be re-inspected?



## Review - Answer

- Change of duty
- Driven 3 hours
- Driven 240 km

# Review

What must be marked on  
the tie down?

# Review - Answer

Working Load Limit

Alberta

---

## Review

How many tiedowns are required for the following cargo?

- 1) 1.52 m (5ft) and 750 kg
- 2) 3.65 m (12ft) and 1500 kg
- 3) 1.21 m (4ft) and 200 kg

## Review - Answer

- 1) 2 tiedowns
- 2) 3 tiedowns
- 3) 1 tiedown

# Front End Structure

- Height and width
- Strength
- Penetration Resistance

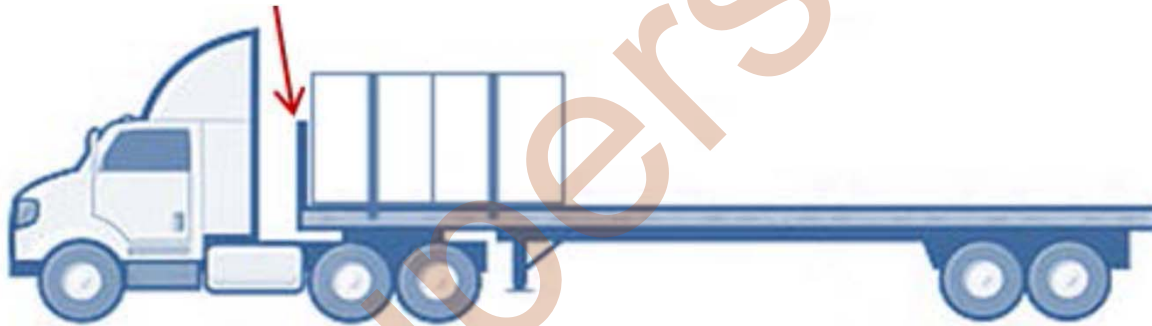

Important - the cab shield is not a front-end structure or part of the cargo system.

# Cargo Placement & Restraint

- Fully Contained
- Immobilized
- General Securement



# Weight Distribution

- Affects of proper and improper weight distribution
- Drivers responsibilities on every trip



# Weight Distribution Cont.

To evenly distribute the load in a trailer:

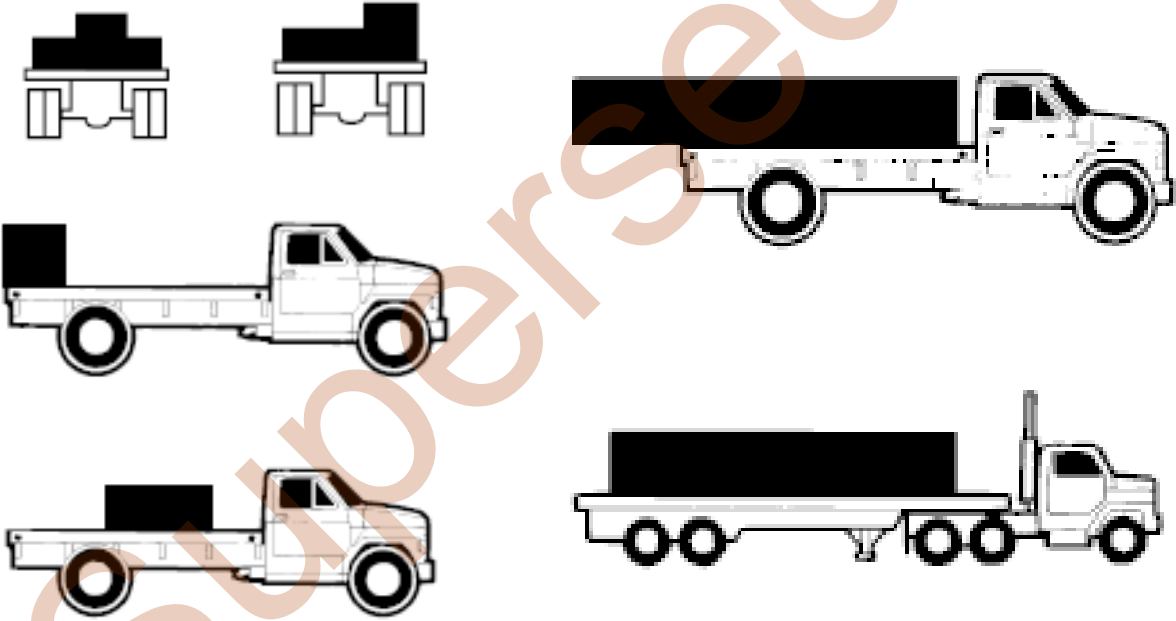

# Specific Cargo Securement

- Logs
- Dressed Lumber
- Metal Coils
- Paper Rolls
- Concrete Pipe

## Specific Cargo Securement Cont.

- Intermodal Container
- Vehicles as Cargo
- Roll-on/Roll-off and Hook lift Containers
- Boulders

**IT IS EXPECTED THAT THE ACTUAL PRACTICAL TRAINING FOR SPECIFIC CARGO WILL BE DELIVERED BY THE EMPLOYER.**

# Review

What is an Anchor point?

## Review - Answer

Structure, fitting or attachment on a vehicle where a tiedown is attached.

# Review

How do you secure  
Tarpaulins?

Alberta

---

# Review - Answer

Rope  
Webbing  
Elastic hooks

# Review

What are the 3 ways cargo can be transported?



# Review - Answer

Fully contained

Immobilized

General securement

Alberta

---

# Review

What happens when the front axles are underweight?

## Review - Answer

Affects safe steering of the  
truck

# Review

Where can you find specific cargo securement regulations?

# Review - Answer

North American Cargo  
Securement Standard (NSC  
Standard)

Alberta

---

## Summary

- Safety
- Drivers responsibility
- Minimize hazards
- Minimize/eliminate fines

# Questions?

---



Superseded

# Module 10 – Handling Emergencies

Superseded



# Purpose

## Module 10:

- ✓ Understand how to handle minor emergencies in a professional manner.
- ✓ What to do if you are involved in a collision.
- ✓ How to handle fire incidents and know the location and capabilities of the fire extinguishers.
- ✓ How to manoeuvre the tractor-trailer in a safe manner in the event of a mechanical breakdown.
- ✓ Recognize the importance of remaining conscious and alert in an emergency.
- ✓ Be prepared to take control and understand the importance of remaining calm.
- ✓ Understand the reasons and correct procedures for deploying warning devices

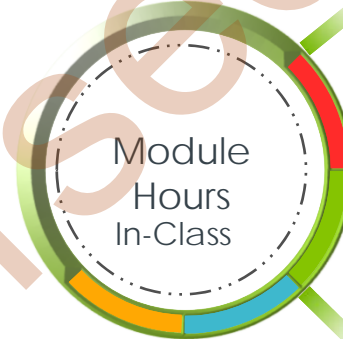

1 hour

### Delivery

- ✓ Lecture, pairs, group, demo, etc.

Assess 30 min

- ✓ Practice, performance, etc.

Alberta

# Driving Habits

- Safe driving habits may assist a commercial truck driver to respond quickly to emergency situations and avoid collisions.
  - Adapts to the presence of other motorists, pedestrians, cyclists and slow-moving vehicles that share the road with the vehicle you are driving;
  - Watch for wildlife or livestock that can enter the space around a vehicle, particularly on routes known for collisions involving animals;
  - Monitor and adheres to highway speed advisories;
  - Maintain a high level of alertness while driving;
  - Scan conditions around the vehicle by looking ahead and using mirrors regularly and systematically;

# Driving Habits

- Monitor vehicle conditions by scanning instruments and gauges regularly and systematically;
- Monitor the movement and actions of other motorists while passing or being passed.
- Diffuse any situation that could cause anger, hostility or danger;
- Exit the vehicle whenever necessary to inspect clearances and identify potential obstructions; and
- Secure a vehicle properly before exiting the cab or vacating the driver seat;

# Emergency Driving Techniques

Skid control and the professional driver:

Loss of traction:

- Skid control
- Faulty brakes
- Excessive acceleration or speed in curves
- Rough or slippery surfaces
- Hydroplaning
- Jackknifing

# Jackknifing

You do not Jackknife unless you skid.

1. The Dangers of Jackknifing
2. Tractor Jackknifing
3. Trailer Jackknifing
4. Recovery / Steering
5. Avoidance

# Braking

- ABS
- Threshold
- Panic

Superseded



# Tire Blow Out

- Tire air leaks
- How to control if a tire blows



Take foot off accelerator pedal

Allow engine to slow vehicle down

Grip steering wheel. Steer straight down center of lane

**DO NOT** apply brakes immediately. Use gentle and steady pressure

Safely move to safe location. Turn hazard lights on and place warning triangles

Alberta

# Loss of Brakes

- Signs of a Brake Failure
- How to handle the emergency situation





## Loss of Visibility

- Headlights Fail
- The Hood Flies Up
- Mud or Slush on the Windshield



Alberta



# Emergency Evasive Action

- Controlled emergency Braking
- Quick Steering with or without Braking
- Leaving the paved portion of the road

## Animals/wildlife

### Action Steps

1. Reduce the chance of a collision with an animal
2. Use your Visual Search Patterns continuously



Alberta

Superseded

# Animals/wildlife

- How to know your in a higher populated area
- Different animals react differently to traffic
- If you have to hit the animal



Alberta

## Breakdowns

- If you breakdown in a rural area
- What are the appropriate warning devices?
- Where do you place them?
- What is the time requirement?

## Minor Collisions

- When to stop or move the vehicle
- Assess the scene – what are you looking for
- Obtain information – what is needed
- Do not discuss who is at fault
- Local policy and procedures
- When to report to police

# Major Collisions

- Assess and evacuate if needed
- Protect the scene – from what and how
- Warning devices
- Summon help
- Treat injuries in order of seriousness
  - Most serious first – not breathing
  - Bleeding – good chance of survival
  - Shock and minor last

## Major Collisions Cont.

- Organize bystanders vs unorganized
- What tasks can you have them do
- How to organize and recruit others to help



## Major Collisions Cont.

- Examples of how you might give instructions

Class discussion:

- Have any of you been in a collision or helped at the scene of a collision where it was necessary for organization?
- What are some other roles for recruits until the authorities get to the scene?

# Emergency Equipment

- Approved warning device
- Triangles/flares - specifications
- Why do we place them
- Where do you place them
- Hazard light use

# Fire and Fire Extinguishers

- Tips to prevent fires
- Where is the extinguisher located
- Dry chemical extinguisher
  - what you need to know



# Fire and Fire Extinguishers

- How to use a fire extinguisher
- P.A.S.S.
- Certification and expiration



*Pull the pin and point the nozzle away from you.*



*Aim low and direct the extinguisher at the base of the fire.*



*Squeeze the handle slowly and evenly. Continue to squeeze until the fire is out and/or the fire extinguisher is empty.*

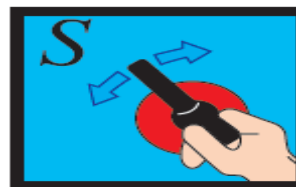

*Sweep the extinguisher from side-to-side. Start at one side of the fire and slowly work to the other side. Do not start in the middle of the fire.*

Alberta

# Review

When are you required to contact police immediately for a collision?

## Review - Answer

- Injury
- Death
- Impaired driver
- Hit and run
- Out of province vehicle
- If a vehicle needs to be towed

# Review

Where are your warning devices supposed to be placed?

## Review - Answer

In line with the vehicle

30 metres (100 ft.)

In front and rear



## Review

When visibility is reduced to 150 metres how far back from the front and rear should the warning devices be placed?

# Review - Answer

75 Metres (245 ft.)

Alberta

---

# Review

What does P.A.S.S. stand for?

## Review - Answer

Pull the pin

Aim low

Squeeze lever

Sweep from side to side

Alberta

# Review

In what order do you treat for injuries at a collision?

## Review - Answer

1. Serious – not breathing
2. Bleeding but have a chance of survival
3. Shock and minor last

## Summary

- Safe driving habits may assist a commercial truck driver to respond quickly to emergency situations and avoid collisions.
- In the event that you can't or if you arrive at the scene of a collision, you should be able to know what to do.
- Make sure to watch for animals and wildlife as they are harder to predict.
- Always make sure you know where to locate your fire extinguisher and how to use it properly.

# Questions?

---



Superseded



# Resources

- Some of the clipart and pictures contained in this document are licensed under public domain, *Creative Commons Zero (CC0)*:  
<https://creativecommons.org/publicdomain/zero/1.0/>
- The Saskatchewan Government Insurance (SGI) Curriculum presentation
- The Commercial Truck Driver Training Course (Class 1) Guidelines and Curriculum
- Alberta Commercial driver's guide
- The *Traffic Safety Act (TSA)* and it's associated regulations:
  - *Use of Highway and Rules of the Road Regulation*
  - *Operator Licensing and Vehicle Control Regulation*
  - *Distracted Driving Regulation*
  - *Traffic Control Device Regulation*
  - *Vehicle Equipment Regulation*
  - *Demerit Point Program and Service of Documents Regulation*
  - *Commercial Vehicle Dimension and Weight Regulation*
  - *Commercial Vehicle Safety Regulation*
  - *Vehicle Inspection Regulation*
  - *Commercial Vehicle Certificate and Insurance Regulation*

Alberta